

GEAR TECHNOLOGY

January/February 2008

www.geartechnology.com

The Journal of Gear Manufacturing



Wind Turbines— The Next (Really) Big Thing

- But Supply Chain Issues Impeding Growth
- States Working to Attract Energy OEMs—and JOBS
- Growth Projections

Technical Articles

- Evaluating Low-Noise Formate Spiral Bevel Gear Set
- Application for Gears with Asymmetric Teeth in Turboprops

And...

Voices—Two States Weigh In On the Economics of Wind Power

THE GEAR INDUSTRY'S INFORMATION SOURCE

WIND, OIL & COAL ARE TRANSFORMED INTO ENERGY... THROUGH DEVICES MADE ON OUR MACHINES



BOURN & KOCH FELLOWS HS1280-300 CNC HYDROSTROKE GEARLESS GEAR SHAPERS

Application	Wind Energy, Oilfield and Mining
Benefits	Provides productive, precise, and powerful methods for producing large, long-face-width, coarse-pitch internal gears
Models Available	This new series of large Hydrostroke Gearless Gear shapers includes five models – HS650-200, HS1280-300, HS1280-450, HS1800-400, and HS2550-400



Star-SU LLC
5200 Prairie Stone Parkway,
Suite 100
Hoffman Estates, IL 60192
USA
Tel: 847.649.1450
Fax: 847.649.0112
sales@star-su.com

BIG JOBS CALL FOR BIGGER MACHINES

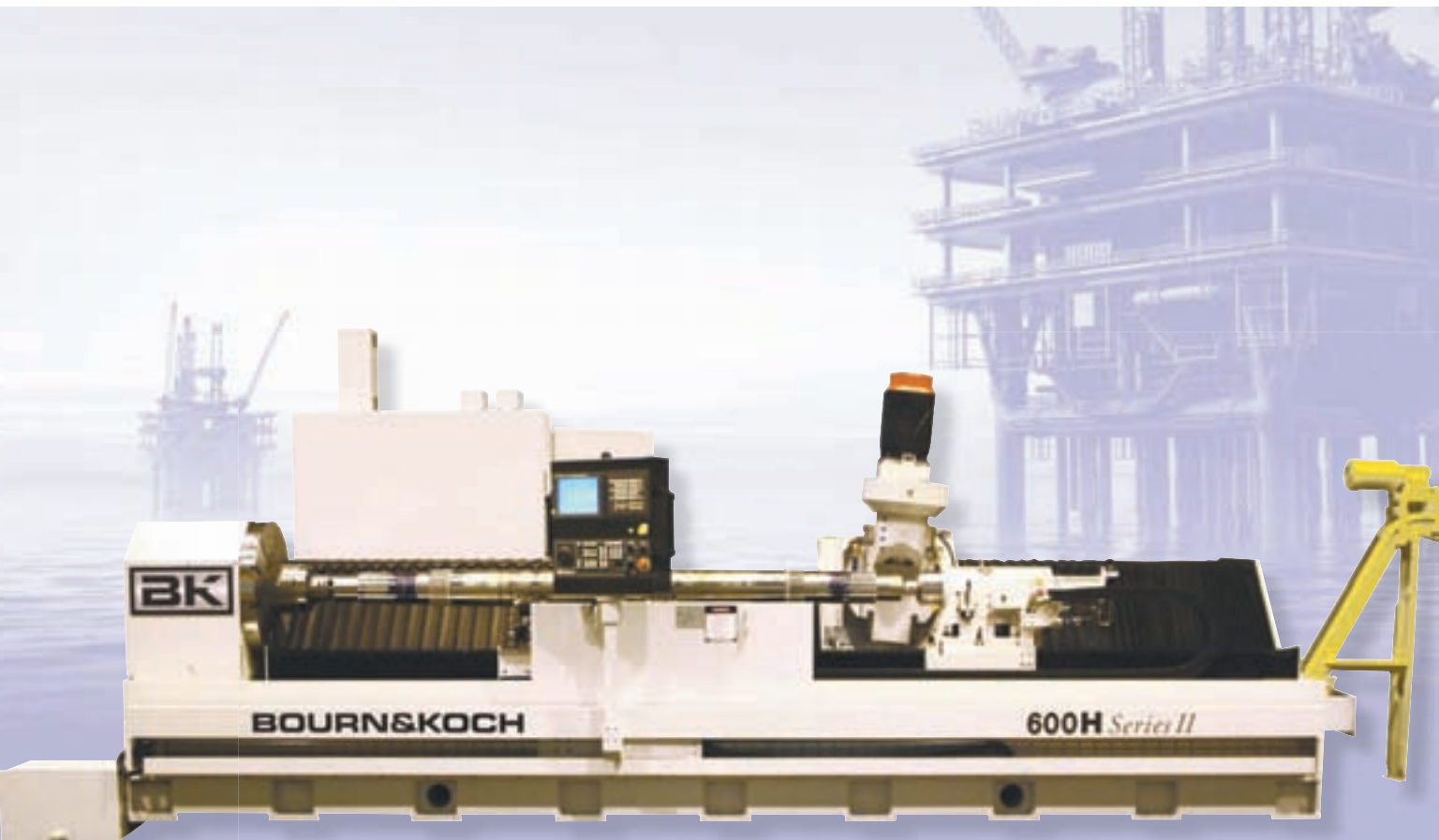

BOURN & KOCH 600H CNC HORIZONTAL HOBGING/MILLING MACHINES

Application	Energy, Oilfield and Mining
Benefits	Longer, more productive machines for hobbing and milling teeth on shaft lengths from 100" to 280"
Available Now	600H machines currently in assembly at Bourn & Koch include 100", 180" and 280" shaft lengths

Also from Star SU

Vertical Hobbing Machines
Gear Shaving Machines
Gear Grinding Machines
– Vertical & Horizontal

Thread and Rotor Grinding Machines
Vertical Chuckers
Rotary Surface Grinders
Vertical OD/ID Grinders
Multispindle Machines

Special Machines
Tool & Cutter Resharpener/Grinding Machines
Remanufactured Machines
Cutting Tools
Tool Services

Get a Quick Quote at <http://www.star-su.com/pages/content/quotes.html>

Go to www.star-su.com

FEATURES

25 Wind Turbines

Good News, Bad News

The domestic wind turbine industry is growing at near-gale-force speed, but kinks in the components supply chain are a problem with no quick fix in sight.



32 It's All Good

Economic development, redevelopment and quality manufacturing jobs. It can happen here.



43 Winds of Change and Ka-Ching, Ka-Ching

Growth projections continue to lag behind actual installations nationwide.



TECHNICAL ARTICLES

46 Formate Design in Helicopter Gear Sets

A NASA Glenn look at how use of Formate design of spiral bevel gears set improves upon noise, vibration and tooth strain.

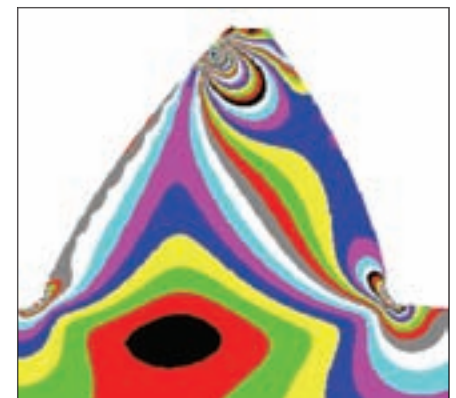

60 Research and Development of First Production Gearbox with Asymmetric Tooth

This presentation looks beyond the better-known benefits of gears with asymmetric tooth profiles in assessing their use in a turboprop engine gearbox.

Go The Extra Micron



THE KAPP KX 500 FLEX

FLEXIBLE

- Cylindrical spur and helical gears to 10 module (2.5 DP)
- Continuous generating and/or profile grinding
- Dual independently-adjusted dressing spindles (optional)

EFFICIENT

- On-board measuring
- Intuitive Kapp HMI software
- Operator friendly, optimized for manual loading
- Robot loading-ready

RELIABLE

The reliability of KAPP and NILES products is world renowned. The KAPP Group is a leader in innovative technology and systems for precision finishing of gears and profiles serving the automotive, aerospace, marine, construction and mining industries.

*Call us for more information
about the KX 500 FLEX machine.*

Geared to make things move.

KAPP **NILES**

www.kapp-niles.de
www.niles.de
www.kapp-niles.com
www.kapp-asia.com
www.kapptec.com

KAPP Technologies
2870 Wilderness Place
Boulder, CO 80301
Phone: (303) 447-1130
Fax: (303) 447-1131
info@kapp-usa.com

DEPARTMENTS

9 Publisher's Page

Getting to the roots of a graying gear industry.

11 Voices

- Iowa's governor is firmly aboard the wind turbine bandwagon
- Wind turbines bringing new prosperity to parts of Ohio, says its lieutenant governor/economic development director
- Crunching the numbers on new machinery—Matt McBride, Riverside Spline & Gear, Inc.

18 Product News

The latest gear industry products

67 Events

AGMA to partner with IFPE in sponsoring a pavillion for IFPE 2008. Also, our must-read technical calendar

70 News

A distilled mix of corporate news, acquisitions, awards and promotions at gear industry companies

77 Advertiser Index

Contact information for companies in this issue

78 Classifieds

Our product and service marketplace

80 Addendum

Gears make the world—and carousels!—go 'round

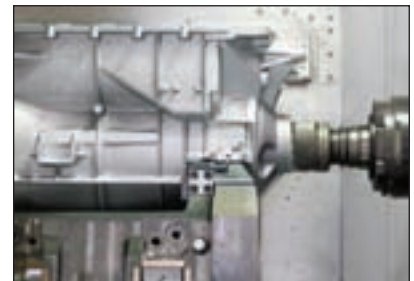

ONLINE

GEAR TECHNOLOGY.com
www.geartechnology.com

- **BUYERS GUIDE**
Search for gear industry products and services and communicate with the industry's leading suppliers.
- **SUBSCRIPTIONS**
Sign up for subscriptions to *Gear Technology* and the geartechnology.com e-mail newsletter.

- **E-GT**
Subscribers get access to back issues of *Gear Technology*.

 **powertransmission.com**
www.powertransmission.com

- **Power Transmission Engineering**
Read the Fall 2007 issue online. Sign up for a free subscription to our new magazine.
- **NEWS**
The latest products, industry news and calendar items.
- **BUYERS GUIDE**
Search for power transmission products and services and communicate with the industry's leading suppliers.

Flexible Technology !



SIGMA  POOL

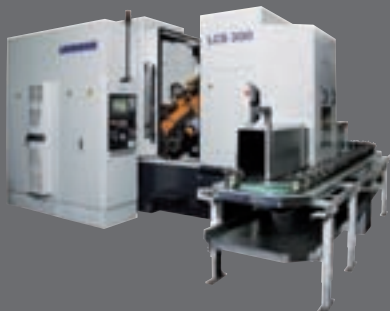

Whatever you need – you can do it!

- choice of grinding process technology
- generating grinding and / or profile grinding
- plated or dressable tools (CBN & corundum)
- multiple gears in one setup
- gear and shaft parts
- advanced software solutions
- different possibilities for noise minimized gear production

Liebherr Grinding Technology - No compromises

LIEBHERR

Randall Publishing, Inc.
1425 Lunt Avenue
P.O. Box 1426
Elk Grove Village, IL 60007
Phone: 847-437-6604
Fax: 847-437-6618

EDITORIAL

Publisher & Editor-in-Chief
Managing Editor
Senior Editor
Associate Editor

Michael Goldstein, publisher@geartechnology.com
William R. Stott, wrs@geartechnology.com
Jack McGuinn, jmcguinn@geartechnology.com
Matthew Jaster, mjaster@geartechnology.com

Technical Editors

Robert Errichello, Don McVittie,
Robert E. Smith, Dan Thurman

ART

Art Director

Kathleen O'Hara, kathyohara@geartechnology.com

ADVERTISING

Advertising Sales Manager

RK Media, Inc. Ryan King, ryanking@geartechnology.com

CIRCULATION

Circulation Manager

Carol Tratar, subscribe@geartechnology.com

RANDALL PUBLISHING STAFF

President
Vice President
Accounting

Michael Goldstein
Richard Goldstein
Luann Harrold



The Mars Hill Wind Farm in Mars Hill, Maine. Photo by Aaron Cushing.



“Or Something Like this...”



OVER 100 YEARS OF COMBINED EXPERIENCE IN REBUILDING, RETROFITTING AND RECONTROLLING MACHINE TOOLS

Whether your requirements are for hobbing or shaping, and you desire to use a PC based system or not, MTB's™ gear cutting software packages are packed with features that rival what is available in new machines today.



Some of the more popular features we offer:

- Dip cycles
- Angled end relief
- Non-contact stock division
- Various shifting strategies
- Measurement and correction by span
- Measurement and correction over balls and pins
- Double helical (herringbone) cycles
- Clamp avoidance
- Re-cut mode
- Near net cycle optimization

Of course there are many more powerful features plus all the basic cycles as well. We continue to improve and expand our offering, and we are willing to modify our software to suit your specialized needs.



TO LEARN MORE ABOUT OUR MACHINE TOOL RECONTROLLING AND REBUILDING, PLEASE CONTACT US.

(815) 636-7502 • WWW.MACHINETOOLBUILDERS.COM





Special Steels

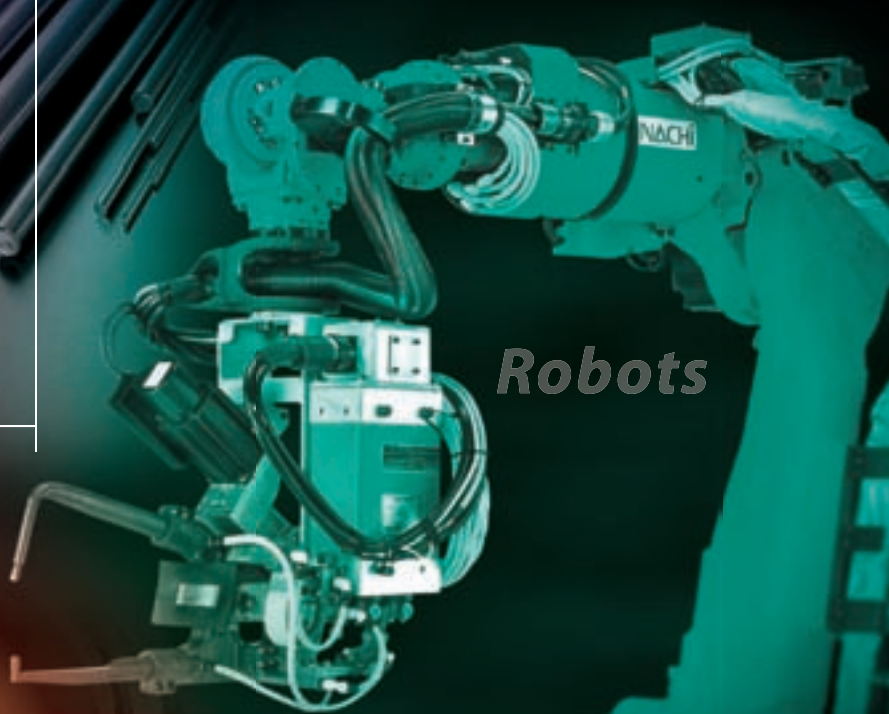

Robots



Bearings

**Wonders from NACHI,
Art in NACHI**
Contributing to progress in the world of Manufacturing.



*Round
Cutting
Tools*



*Hydraulic
Equipment*



*Machine
Tools*

NACHI

NACHI AMERICA INC. URL : <http://www.nachiamerica.com/>
17500 Twenty-Three Mile Road, Macomb, Michigan, 48044, U.S.A. Tel : 586-226-5151 Fax : 888-383-8665

NACHI CANADA INC. URL : <http://www.nachicanada.com/>
89 Courtland Ave., Unit No.2, Concord, Ontario, L4K 3T4, CANADA Tel : 905-660-0088 Fax : 905-660-1146

ETC "THE LEADER IN MANUFACTURING PRECISION SPIRAL BEVEL GEAR TOOLING AND RECONDITIONING OF BEVEL CUTTER BODIES"

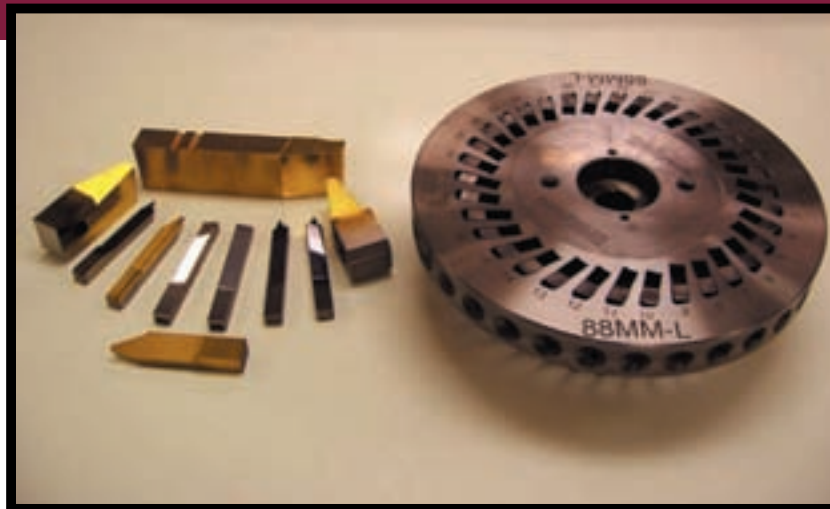

We offer the following products and services:

- TRI-AC®, RSR®, RIDG-AC®, HARDAC®, SPIRON II® Style Blades and Others
- HSS Grades Available
REX 76, M4, ASP30
- Cutter Bodies Repaired and Refurbished to O.E.M. specifications
- Maintenance program for all Cutter Bodies
- Replacement hardware "Screws and Clamps" for TRI-AC® cutter bodies 51mm through 175mm
- Oerlikon Balzers PVD Coatings
- Rough Form Wire Service

TRI-AC®, RIDG-AC®, HARDAC® and RSR® are registered trademarks of The Gleason Works, Rochester, New York

SPIRON® II is a registered trademark of Klingelberg AG, Zurich (Switzerland)

INTRODUCING

Our New Cutter Body Maintenance Program. Program includes cleaning and inspection of all hardware. Complete inspection and certification to O.E.M. specifications. Inspection report and maintenance log by serial number for tracking history.

Our ETC-809, ETC-807 and ETC-805 are Specially Formulated Carbide Grades developed exclusively for High Performance Bevel Gear manufacturing. Our grades teamed with Balinit P.V.D. coatings enable us to approach each and every specific application in the bevel gear industry for **OPTIMUM PERFORMANCE.**

Call Ross Deneau Today!

for all of your cutter body needs

Our new manufacturing facility in Troy, MI.

PH: (248) 619-1616 • FAX: (248) 619-1717

rdeneau@engineeredtools.com

ETC Engineered Tools Corporation

**Manufacturer of Precision Spiral Bevel Gear Tooling
And Reconditioning of Bevel Cutter Bodies**

Engineered Tools Corporation
2710 West Caro Rd. Caro, MI 48723
PH: (989) 673-8733
FAX: (989) 673-5886

To View
Our Complete Product Line
www.engineeredtools.com



The Graying of the Gear Industry

The gear industry is getting old, fast.

I was struck by that fact at Gear Expo, where most of the people I saw at the show had gray or white hair.

Of course, I'm not telling you anything you don't already know. More and more people in the industry have told me they've tried to retire, but their companies keep offering them incentives to stay on—as consultants or part-timers—whatever it takes to keep them working.

A similar group of people probably work at your own company. They've spent decades figuring out the best ways to make your products or your customers' products. In fact, if you're reading this, there's a good chance you're one of them.

Who will help your company solve gear manufacturing problems when you retire? Are we training enough of another generation of Americans to take over when the time comes? Who is motivating young people to pursue careers in manufacturing and engineering?

When I was a little boy, I used to take things apart and try to put them back together again to figure out how they worked. I have always had an inclination toward

and curiosity about machines and mechanical processes, as I suspect is the case with most of you. Around age 8 or 9, I was fortunate enough to go on a school field trip to the Ford assembly plant in Chicago. I remember being awed by seeing all those parts coming together and, at the end of the line, a guy jumping into the car, turning the key, and driving a finished automobile off the line. I was fascinated. It was an experience that helped focus my interest in engineering.

We need something similar to inspire and encourage the kids of today. The kids are no different, but we are.

We live in a service-oriented economy. Most people are too far removed to even know what happens in a manufacturing plant. Automobiles come from dealers, washing machines come from stores—with never a thought of how or where they're made. People know what doctors or lawyers do. But manufacturing engineers? Many of you work at state-of-the-art manufacturing facilities with clean floors, fresh air, good lighting, and machines that work by themselves, but most people have a 1940s vision of factories—dark, noisy, smelly and dangerous, with no future for those who worked there. Teachers,

parents and school counselors are totally disconnected from the reality of manufacturing today and how rewarding a career in manufacturing can be.

You may think you're not in a position to help. But you don't have to be the company president to come up with ideas to change how our kids think about manufacturing. Do you know of any youth groups who could benefit from exposure to the real world of manufacturing? What about your local schools, scout groups, etc.? Can you arrange to invite them to come and tour your facility? If that doesn't work, can you go and visit them? Give a presentation. Show them pictures. Do something.

Getting kids interested in manufacturing as a career isn't just a smart move that could provide future employees for your company. It's an investment in our country.

Most of you already understand the importance of a strong manufacturing base to our nation's economy, defense and overall welfare. We simply cannot afford to allow all of our manufacturing know-how to disappear when the current generation of experts retires. Remember, when you retire, your welfare—and your nation's welfare—will be dependent upon the skills of the next generation. Will you feel comfortable in your retirement knowing that your country has lost the ability to



Is this how people think of factories? The gear industry has come a long way since this photo, taken in 1945 at the Massey Harris gear plant in Racine, WI. In the far background, leaning against a machine, is Harold Goldstein, the author's father.

make things for itself?

There are a lot of 8- or 9-year-olds out there—some with the right curiosity to be engineers, production managers, CNC programmers, shop foremen or six sigma black belts. It's a shame they don't know those possibilities exist.

Michael Goldstein,
Publisher & Editor-in-Chief

P.S. If you or your company are doing anything to help encourage young people to consider manufacturing careers, we'd like to hear about it. Send your letters to publisher@geartechnology.com

3 DIFFERENT MACHINES DIFFERENT DESIGNS

HOBGING ≠ SHAPING

GRINDING ≠ HOBGING

SHAPING ≠ GRINDING

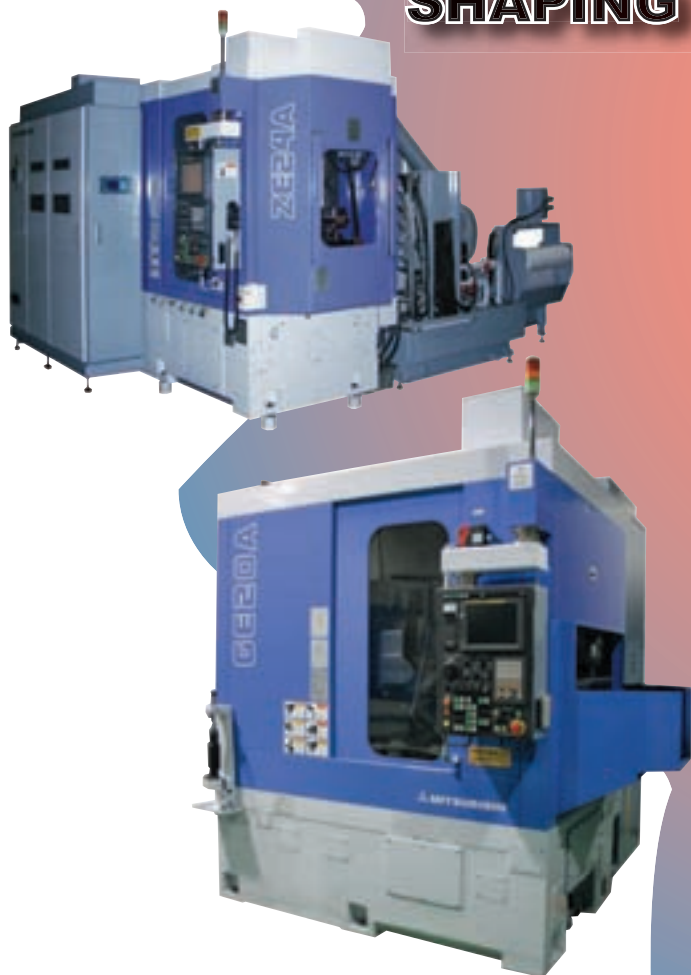

Each of our E series machines have been designed for a specific application. Using the tools of Finite Element Analysis and three dimensional CAD, we have been able to optimize our machine designs to efficiently and economically produce gears. Each unique design is capable of handling all of the varied loads, stresses, heat and process byproducts generated by the cutting or grinding conditions.

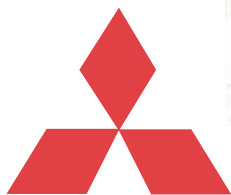

Mitsubishi

Mitsubishi Heavy Industries America, Inc.

Machine Tool Division

46992 Liberty Drive • Wixom, Michigan 48393 • ph: 248-669-6136 • fax: 248-669-0614

www.mitsubishigearcenter.com



Iowa's 21st Century Renewable Energy Expedition

By Iowa Governor Chet Culver

As Governor of the state of Iowa, I have seen firsthand the incredible growth of the Iowa wind industry. I strongly believe wind energy is one of the most important components necessary to reduce carbon emissions and wean ourselves off foreign energy sources.

We are charting our own course toward energy independence with the creation of a new, state-level office dedicated solely to making Iowa the first state in the nation to be energy independent by 2025. It is fair to say there is no state better positioned, both figuratively and literally, than Iowa to lead a 21st Century Renewable Energy Expedition.

It is also fair to say our greatest opportunity may lie in wind generation.

First, Iowa is situated in the heartland of America, with excellent transportation options—whether by river, rail or road. This gives Iowa businesses an easy and affordable distribution network across the country and around the world.

This transportation advantage allows Iowa's businesses to move their products efficiently and cost-effectively—24 hours a day, seven days a week.

Second, our natural strengths in education and manufacturing have produced a world-class workforce that can meet any employer's needs. Iowa's public and private Pre-k through 12th grade schools, community colleges, and colleges and universities are some of the very best.

Third, our combination of quality of life, safe communities and affordable

living is second to none.

Iowa is a great place to live. We are currently ranked as the sixth most livable state in the country, and our capital city was recently named by *Kiplinger* magazine as the third-best place in the nation to work and raise kids.

I am very pleased the wind industry has already taken notice of everything Iowa has to offer. Iowa is one of only two states in the nation to manufacture wind turbines, blades and towers. Over 5,000 new, green-collar jobs are projected in Iowa as a result of our commitment to wind energy.

Iowa currently ranks third in the nation in wind production. We have more than 1,000 wind turbines in operation statewide, producing nearly 1,000 MW of clean electricity. We are on track to achieve our goal of producing over 2,000 MW of wind energy by 2011, and I have set a new goal of reaching 2,015 MW of wind energy by 2015.

The environmental benefits are clear; and so is the positive impact wind energy has on the economy.

In Iowa, we are moving forward with the amazing opportunities wind power has to offer. We are showing the world that economic growth and environmental protection can, should, and must be complementary interests.

Thank you to the readers of *Gear Technology* magazine for your interest. I hope you will come to Iowa and take part in our 21st Century Renewable Energy Expedition.

Chet Culver,
Governor of Iowa



Wind turbines spanning the horizon bear testament to successful efforts by Iowa's governor and legislature to attract industry-related OEMs and suppliers to their state. The benefits are two-fold: clean alternative energy and well-paying jobs. Photo courtesy of Mitsubishi.

Ohio is Forging Strong Links in Wind Turbine Supply Chain

By Lt. Governor Lee Fisher
—Director, Ohio Department of Development



Ohio Lt. Governor and Director of Economic Development Lee Fisher on a tour at wind energy supplier Magna Machine near Cincinnati. Ohio has worked diligently to become a U.S. leader in the manufacture of wind turbine components in a remarkably short time.

Energy is the force that quite literally shapes the economic climate for Ohio's existing and future businesses, and we have an opportunity and an obligation to maintain the competitive advantage of Ohio's businesses by ensuring sound, reliable access to and delivery of power.

Perhaps nowhere on earth is the economic climate more strongly connected to the availability of affordable energy than Ohio. Ohio is fifth among the states in overall energy consumption, and our economy spends more than \$30 billion on energy every year.

Right now, as a host of geopolitical, economic, and environmental issues converge on the single subject of global energy supply, every current and emerging industrial power is urgently seeking new forms of energy to keep businesses and lives running smoothly, to build energy independence, and to keep the environment intact. An increasingly diverse array of Americans—business leaders,

government officials, environmentalists and consumers—is concerned about what many people perceive to be an uncertain energy future.

Our country's present energy challenges provide Ohio with a unique and exciting opportunity to secure quality jobs of the future while safeguarding our state's businesses, families and our environment. Ohio is perfectly positioned to supply the ideas, the equipment and the processes the world needs. We are seizing the moment that is before us and investing in our Advanced Energy future, particularly in the area of wind.

Wind energy is the world's fastest-growing energy resource, and Ohio can capitalize on this rapidly growing industry by leveraging our existing strengths and assets. Already, the wind industry is creating wealth and jobs across Ohio. In 2006, wind generated \$250 million in revenue, creating a total of 1,700 direct and indirect jobs in our state.¹

When it comes to wind, Ohio has the best supply chain in the country. At present, our state has more than 50 globally competitive companies spanning the state in the wind energy supply chain. Avon Bearings Corporation in Avon, and Rotek International in Aurora are the only U.S. manufacturers of slew rings and bearings for the wind industry, while Magna Machine in Cincinnati machines nose cones and wind turbine housings. From castings for gearboxes, to bearings, to tension bolts, to pitch control systems, Ohio companies already are manufacturing key components for this rapidly growing industry.

Many companies, well-known for producing products for industries other than energy, are getting into the game. This is true for both large and small companies. Owens Corning in Toledo is translating its materials expertise to improve the blades used on wind turbines. Minster Machine of Minster, a family-owned machine press manufacturer established more than 100 years ago as a blacksmith shop, has launched a new division—Minster Wind. A compelling testament to the potential of the advanced energy industry as a jobs and wealth generator, Minster Wind aims to re-position the company away from a declining industry to the advanced energy sector through the manufacturing of wind turbine components.

Growing a strong supply chain is important for two reasons. First, it will create new jobs and investment from current Ohio component manufacturers. Second, it will attract new companies to Ohio by providing the critical necessary resources, access to a skilled workforce, manufacturing capacity, and transportation infrastructure as well as

continued



COMMONSENSE

SAYS THAT THIS IS ABOUT AS LOGICAL AS A SERVICE VAN
WITHOUT AN INVENTORY OF PARTS AND TOOLS ON BOARD.



At Haas, we know that the only way you make money is by making chips, and that means keeping your Haas equipment running in top condition. Our Platinum One-Call policy provides dependable, immediate response and expert service to keep you making chips. Through our network of Haas Factory Outlets, we've built an elite crew of factory-trained and certified service technicians who focus exclusively on Haas machines. Arriving in fully stocked Haas service vans that have the machine parts, tools and special equipment on board, our technicians are able to successfully repair your machine the first time out more than 90% of the time.



Simple. Innovation.



proximity to wind resources. The Great Lakes Wind Network has begun the process of assisting and growing the Ohio wind supply chain by connecting leaders from manufacturing companies serving the wind sector through educational programs and networking opportunities.

Ohio's existing assets place us in an excellent position to capitalize on the growing advanced energy industry. By leveraging our historic strengths—our large manufacturing base and dedicated workforce—we have the ability to capture and sustain a competitive advantage in the industry by producing

the key components of advanced energy sources. A commitment today to advanced energy will reap enormous rewards tomorrow. The Renewable Energy Policy Project, for example, found that Ohio has the second-greatest job-generating potential in the country in advanced energy—second only to California—with a potential for 24,000 new jobs.

The state is committed to partnering with businesses and community stakeholders across Ohio to support advanced energy production and to drive demand. The Ohio Department of Development is investing \$21 million from Ohio Third Frontier funds to accelerate the development and growth of advanced energy. The Ohio Energy Office at the Ohio Department of Development recently awarded \$5 million in grants to two utility-scale wind energy projects: the Buckeye Wind project developed by EverPower Renewables in Champaign and Logan counties, and the JW Great

Call us about our NEW SU250 Gear Grinding Machine in our South Bend plant.

There's no such thing as a gear tooth fairy.

Inferior gears can take a real bite out of productivity. At Schafer Gear, we know our reputation depends on the quality of our products. So our investment in the latest turning, gear cutting, gear grinding and other state-of-the-art equipment is designed to produce the highest quality gears for our customers. And the quality of our equipment is matched only by the commitment of our staff and alliance partners to provide you with the exceptional service you deserve. If your gears are losing their bite, don't put them under your pillow and make a wish. Call us.

SCHAFER
GEAR WORKS, INC.

South Bend, IN • Rockford, IL
www.schafergear.com
574-234-4116

©2008 Schafer Gear Works, Inc.



Ohio was cited by the Renewable Energy Policy Project as having the second-greatest job-generation potential—24,000 jobs—in the country.

Lakes Wood County Wind Farm in Wood County from the Department's newly created Ohio Wind Production and Manufacturing Incentive Program. These large-scale wind power projects are catalysts to attract potential wind manufacturing-related jobs.

In order to secure those jobs, Ohio must prove its commitment to advanced energy use. This is why Governor Ted Strickland's "Energy, Jobs and Progress" plan includes an Advanced Energy Portfolio Standard requiring that at least 25 percent of the electricity sold in Ohio be generated from advanced energy technology by 2025. Half of that advanced energy must be produced in Ohio, and half must be from renewable sources.

When it comes to attraction and retention of jobs in a state, an Advanced Energy Portfolio Standard is becoming an increasingly important variable. Over the last two years, eight wind turbine manufacturing companies have set up operations in the United States, with seven of those companies located in states with a Renewable Portfolio Standard. Our regional neighbors, with whom we regularly compete—Pennsylvania, Illinois, Minnesota and Iowa—already have Renewable Portfolio Standards in place. Several companies with operations in Ohio, such as General Electric, Ohio's second-largest manufacturer, have the opportunity to manufacture components of wind turbines here but currently are choosing to do so closer to centers of demand. Component production has incredible potential for Ohio; a Portfolio Standard will create the baseline demand to get these new opportunities sited in our state.

Advanced energy is expected to grow from a \$55 billion global market to a \$226 billion global market in a decade. Wind power alone is projected to grow from a \$17.9 billion to a \$60.8 billion market, according to Clean Edge, an investment research and publishing firm. Ohio's rich manufacturing legacy, our talented workforce and work ethic, our proximity to the major electric load

centers and to wind resources, and our transportation network from barges to rail to highway can all be leveraged towards attaining global leadership in renewable energy industries. Ohio is ideally situated at the nexus of the required supply chain and consumer base.

The moment to build an advanced energy industry in Ohio is now.

Lee Fisher,
Lt. Governor of Ohio

1. Source: Management Information Services, Inc., and American Solar Energy Society, 2007

Lowest Cost Per Piece!

Colonial's promise to the Broach industry is simple:
At Colonial our Lowest Cost Per Piece (LCPP™) Management Team will assist your firm in establishing a lowest cost per piece.
A Broach Industry FIRST!

Colonial is able to deliver on this promise by taking advantage of our "decades of experience" that benefits our Lowest Cost Per Piece (LCPP™) Managing Team by providing you with a broaching system with a lowest fixed cost per piece.

Colonial
EXPERIENCED • RELIABLE • INTERNATIONAL

Brett Froats
President Broach Division

Taylor, Michigan • Windsor, Ontario • 1-800-611-5119 • bmfroats@bnsi.net • www.colonialtool.com

How Much Does that New Machine Really Cost?

After reading Fred Young's editorial, "Reinvesting in New Equipment Pays Dividends" (*Gear Technology* – November/December 2007), I was compelled to throw in my two cents regarding the tax aspects of equipment purchases, aspects to which Mr. Young alluded.

Without engaging in a debate over the appropriateness of current federal income tax rates or the tax system itself, I think we can all agree that taxes affect our businesses in a significant way. As such, any intelligent decisions we make regarding our businesses, including decisions related to the purchase of new equipment, must take into account the tax consequences involved.

The tax treatment of capital expenditures will differ from one business to another, depending on factors such as the organizational structure of the business (LLC, corporation, S corporation, etc.), the taxable income of the company and the dollar amount spent on equipment in a given year. The main thing to keep in mind, regardless of these factors, is that depreciation deductions will most likely allow a profitable company to recoup a sizeable portion of the money spent on equipment through reduced income taxes. The tax savings from these deductions could very well amount to 28–35% of the

money spent on capital investments.

Tax deductions associated with the purchase of manufacturing equipment are typically taken over a period of seven years, but there are provisions within the federal tax code which allow certain companies to depreciate equipment much faster. For smaller companies who spend less than \$510,000 on equipment in a year, a deduction for the full purchase price may be available in the year of purchase. This "accelerated depreciation" is due to a special tax law provision (Section 179), which allows a company to deduct up to \$128,000 of equipment purchases immediately—so long as the company spends less than \$510,000 during the year on qualifying equipment acquisitions. These numbers are for tax years ending in 2008.

To illustrate the significance of these tax deductions, assume a small company spends \$120,000 on equipment in 2008. If that company qualifies to use the accelerated depreciation provisions of Section 179, and the company pays tax at the typical corporate income tax rate of 35%, the federal tax savings in the year of purchase will amount to \$42,000. In essence, the company's out-of-pocket cost for the equipment is \$78,000 rather than \$120,000 (\$120,000 purchase price, minus \$42,000 in tax savings). This example is also true for S corporations and LLCs, which pay no federal income tax. For these companies, the tax savings are passed through to the owners, reducing the amount of cash distributions needed from the company to cover the owner's tax bill for the year. This drastically alters the cash flow and financing analysis related to such a transaction. If the company does not qualify under Section 179, those tax savings still exist, but they are just spread over the span of several years, typically seven.

Mr. Young, in his editorial, points to a variety of factors contributing to

his capital expenditure philosophy. He notes decreased setup times, more efficient run times, higher quality gears and a higher volume of production without proportionately higher direct labor costs. These are all factors related to advancements in technology, and I would imagine these factors are understood by anyone in the gear manufacturing business. However, other factors mentioned by Mr. Young—most notably the tax factors—may be overlooked by a business owner when making the decision to acquire new machinery. I suspect many smaller businesses, those without the benefit of a tax or finance department, make these decisions based solely on sticker price, with no consideration given to the impact of their decision on the company tax returns. The result could be faulty decisions based on incorrect financial assumptions.

I was glad to see Mr. Young mention the role of tax strategy in his capital investments analysis. It is apparent that he understands these considerations are not inconsequential footnotes to this discussion, as many business owners may believe them to be. Of course, state taxes, property taxes and a company's specific income tax situation will all impact this analysis, and experience tells me it is beneficial for a business owner to consult with a CPA (or other qualified tax advisor) whenever kicking around the idea of making a significant capital acquisition. Getting tax advisors involved early in the decision making process will ensure the broadest range of options and strategies, as many of these strategies require action before the equipment is even placed in service.

Does this mean we should all run out and spend \$1 million on new equipment in order to save taxes? Of course not—it would be foolish to suggest spending \$1 million to save a potential of \$350,000 in taxes over seven years. What this does

VOICES

Reinvesting in New Equipment Pays Dividends

Frederic M. Young, president, Forest City Gear Corporation

Recently, I was approached by a colleague who was impressed by the article in your issue. Your gear magazine has been instrumental in helping me understand the tax aspects of equipment purchases, aspects to which Mr. Young alluded. Without engaging in a debate over the appropriateness of current federal income tax rates or the tax system itself, I think we can all agree that taxes affect our businesses in a significant way. As such, any intelligent decisions we make regarding our businesses, including decisions related to the purchase of new equipment, must take into account the tax consequences involved. The tax treatment of capital expenditures will differ from one business to another, depending on factors such as the organizational structure of the business (LLC, corporation, S corporation, etc.), the taxable income of the company and the dollar amount spent on equipment in a given year. The main thing to keep in mind, regardless of these factors, is that depreciation deductions will most likely allow a profitable company to recoup a sizeable portion of the money spent on equipment through reduced income taxes. The tax savings from these deductions could very well amount to 28–35% of the money spent on capital investments. Tax deductions associated with the purchase of manufacturing equipment are typically taken over a period of seven years, but there are provisions within the federal tax code which allow certain companies to depreciate equipment much faster. For smaller companies who spend less than \$510,000 on equipment in a year, a deduction for the full purchase price may be available in the year of purchase. This "accelerated depreciation" is due to a special tax law provision (Section 179), which allows a company to deduct up to \$128,000 of equipment purchases immediately—so long as the company spends less than \$510,000 during the year on qualifying equipment acquisitions. These numbers are for tax years ending in 2008. To illustrate the significance of these tax deductions, assume a small company spends \$120,000 on equipment in 2008. If that company qualifies to use the accelerated depreciation provisions of Section 179, and the company pays tax at the typical corporate income tax rate of 35%, the federal tax savings in the year of purchase will amount to \$42,000. In essence, the company's out-of-pocket cost for the equipment is \$78,000 rather than \$120,000 (\$120,000 purchase price, minus \$42,000 in tax savings). This example is also true for S corporations and LLCs, which pay no federal income tax. For these companies, the tax savings are passed through to the owners, reducing the amount of cash distributions needed from the company to cover the owner's tax bill for the year. This drastically alters the cash flow and financing analysis related to such a transaction. If the company does not qualify under Section 179, those tax savings still exist, but they are just spread over the span of several years, typically seven. Mr. Young, in his editorial, points to a variety of factors contributing to his capital expenditure philosophy. He notes decreased setup times, more efficient run times, higher quality gears and a higher volume of production without proportionately higher direct labor costs. These are all factors related to advancements in technology, and I would imagine these factors are understood by anyone in the gear manufacturing business. However, other factors mentioned by Mr. Young—most notably the tax factors—may be overlooked by a business owner when making the decision to acquire new machinery. I suspect many smaller businesses, those without the benefit of a tax or finance department, make these decisions based solely on sticker price, with no consideration given to the impact of their decision on the company tax returns. The result could be faulty decisions based on incorrect financial assumptions. I was glad to see Mr. Young mention the role of tax strategy in his capital investments analysis. It is apparent that he understands these considerations are not inconsequential footnotes to this discussion, as many business owners may believe them to be. Of course, state taxes, property taxes and a company's specific income tax situation will all impact this analysis, and experience tells me it is beneficial for a business owner to consult with a CPA (or other qualified tax advisor) whenever kicking around the idea of making a significant capital acquisition. Getting tax advisors involved early in the decision making process will ensure the broadest range of options and strategies, as many of these strategies require action before the equipment is even placed in service. Does this mean we should all run out and spend \$1 million on new equipment in order to save taxes? Of course not—it would be foolish to suggest spending \$1 million to save a potential of \$350,000 in taxes over seven years. What this does

mean is that when faced with the decision of whether your organization should be purchasing equipment, for reasons unrelated to taxes, the anticipated cash flow and financing projections should take into account the substantial impact of income tax deductions. When the tax savings from depreciation deductions are taken into account, business owners may realize they have a lot more buying power than they originally thought.

Matt McBride,
Chief Financial Officer,
Riverside Spline & Gear, Inc.

Speaking Up Does Make A Difference

Dear Mr. Goldstein,

I wanted to thank you for your editorial in the November/ December issue of *Gear Technology*. As a younger man who wonders what will happen when I retire, it is refreshing to see someone who is near the age of retirement question the current system. It is extremely discouraging to pay that 15% tax and think that there won't be anything left for me when I need it.

As you point out, the tax burden on younger families is a real problem. We can not realistically rely on Social Security, yet when we are paying 40% of our income in taxes, it is extremely difficult to save for retirement. I recently heard a statistic that one out of every five workers is employed by the government. That implies that the other four workers are paying that government employee's salary. Sure, everyone has a different income, but since government employees are paid relative to local salaries or wages with the GS system, it is probably fair to say that on average, 25% of the non-government employees' salary goes to pay that government salary. That seems pretty close to the reality of my taxes.

You stated you "have no solution to these problems, only concerns," but I think you have already contributed to the solution. I believe that those currently in positions of influence or power need to speak out, and you have. Nothing can ever change if we don't even think or talk about it, and change never happens without a little pain. Everyone in this country with an education knows Social Security is a problem, but it is very difficult to discuss. No one wants to be the heel to take away Grandma's or Mom's SS check. No one wants

to offend friends or associates by questioning their perceived entitlements. Talk alone will of course never change anything; the questioning of the current status quo and soul searching by those of intelligence when a problem is thrust into their conscience must be the start. I hope you are a very lucky man and live long enough to see this problem resolved.

Regards,
Tom Schmitt,
Schmitt Design, Crystal, MN

TSA Growing With Our Customers
New Product Line

Hobs **NEW!**
Shaper cutters • Shaver cutters
Chamfering & Deburring tools
Master gears • Spline gages

A Complete Manufacturing Source For All Your Gear Cutting Tool Needs

35 Years of
Technical Expertise
Advanced Technology &
Modern Up-To-Date
CNC Equipment
Knowledgeable & Experienced
Engineering Staff
Premium Quality
Short Deliveries
Competitive Pricing

TSA
The gear industry's smart option

TSA America LLC
30311 Clemens Road, Ste. 2, Westlake, OH 44145
Tel: (440) 614-0170 • Fax: (440) 614-0173 www.tsagear.com

American Wera Profilator

INTRODUCES SCUDDING PROCESS

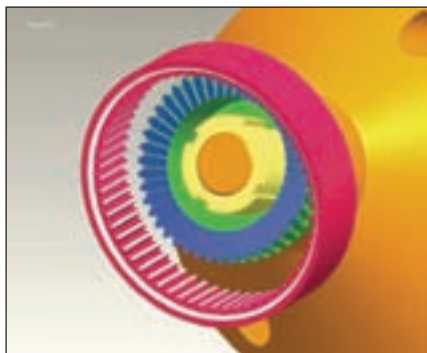

Rolled out at EMO 2007, the Scudding process is a continuous cutting operation that uses a tool design similar to a helical shaper cutter. It can be used for a wide range of gear applications including involute gears like sprocket or ring gears or on non-involute or non-symmetrical gears, like belt pulleys or straight synchronic gears.

In Scudding, the cutter feeds directly through the workpiece as the cutter and workpiece spin in a synchronized fashion. According to Scott Knoy, vice president of sales at American Wera Inc., the process can cut a gear in nearly the same time as hobbing and can be five to six times faster than shaping an internal gear.

The machine was originally developed for sliding-sleeve internal splines for manual transmissions, but it was soon realized that it could cut internal gears, external gears and non-symmetrical forms, and it could hard-finish internal gears with a carbide cutter.

“The response to the product has been very good,” says Knoy. “The automotive, aircraft, power tools and wind energy industries showed interest in the machine when it was introduced at EMO 2007.”

According to Knoy, the appeal of

the technology was the cycle time and the flexibility to cut either internal or external gears. Daimler Europe currently has three machines on order and Tremec in Mexico has expressed interest as well.

“We currently have several tests scheduled to work in these different fields,” says Knoy. “The challenge will be to increase the capacity well over the current 320 mm size limit.”

The technology itself is a current slant on an older hard-gear finishing process developed in Germany called walzschaelan, (translated as “hob-peeling”). The elements of hob-peeling are now being used in a different manner, providing the current green process called Scudding. Wera is currently testing the hard finishing process using a carbide-cutting tool.

The Wera machine line offers five processes including Scudding, gear cutting, gear tooth pointing, lock-step milling/pocket groove milling and polygon generation. The machines can be arranged three ways:

1. With a single process with one work spindle and one cutter spindle.
2. Two processes with one work spindle and two cutter spindles.
3. Three processes with two work spindles and three cutter spindles.

In the past, the processing of a sliding sleeve required operations such as turning, broaching, tooth-pointing, groove milling and lock-step milling on multiple machines. Separate washing stations were often required as well.

Innovations in cold- or net-forming technologies made it possible to produce “near finish” sliding sleeves, eliminating steps such as turning and

broaching. The Wera machine allows the combination of Scudding, tooth pointing, lock-step milling and groove milling in a single machine.

According to the company’s press release, the new machine can reduce investment costs as well as personnel and labor. With fewer machines required, there’s more floor space and reduced energy consumption. Less inspection costs also add to its appeal.

For now, Wera Profilator is working with a German gear tool manufacturer and a German university to iron out the process. Currently, there’s a cross axis angle between cutter and workpiece that results in a small amount of over-travel in the cutting process. It’s an issue the company is addressing, using cutting tool technology and machine axial movements.

To see videos of scudding in motion, visit www.geartechnology.com/news.php?in=1471.

For more information:

AmericanWera Inc.
4630 Freedom Dr.
Ann Arbor, MI 48108
Phone: (734) 973-7800
Fax: (734) 973-3053
E-mail: info@profilator.de
Internet: www.profilator.de

Guyson

INTRODUCES BLAST CABINET

Guyson’s single-spindle blast machine allows 360-degree coverage

by timed blast- and blow-off cycles, performed as a workpiece rotates. The blast cabinet features a touch-screen panel for spindle rotation speed or blast cycle duration. Both text and graphic indications occur when faults such as insufficient air supply pressure or low media levels are detected. A human operator, automated pick-and-place device or robot can configure the system.

The system is designed to use mineral grit abrasives such as aluminum oxide and silicon carbide to produce a specified texture or roughness on target surfaces. Abrasion protection features are built-in to resist erosion.

Interior surfaces have a bonded, abrasion-resistant rubber lining, as well as urethane rubber hoses that are fitted with hard, boron carbide nozzles. Prospective users of automated grit-blasting systems are encouraged to submit sample components for free laboratory testing.

For more information:

Guyson Corp.
13 Grande Blvd.
W.J. Grande Industrial Park
Saratoga Springs, NY 12866-9090
Phone: (518) 587-7894
E-mail: jccarson@guyson.com
Internet: www.guyson.com



Rex-Cut
INTRODUCES
INTERLEAF
FLAP DISCS

The Rex-Cut Fusion Flap Disc combines two types of abrasive layers for one-step grinding and finishing. According to the company's press release, the flap disc is longer-lasting than traditional surface conditioning discs. They're offered in coarse, medi-
continued

**Out of This World
Gear
Tooling**

**QUALITY
TECHNOLOGY
PRECISION MANUFACTURING
OPERATIONAL EXPERTISE**

P E R F O R M A N C E

The quality and precision of our broaches and gears have won customers worldwide (and beyond!) – from the smallest gear-shop to NASA and the Mars Rover.

Precision manufacturing, modern equipment, advanced technology, and quality control, balanced with talented craftsmanship, means you get nothing but the *very best*.

Guaranteed the most rigid shank cutters and the highest quality level disk cutters made. Products that perform. Why use Broach Masters/Universal Gear? Because your *parts matter!*

As a complete source for all your tooling and production needs. Broach Masters/Universal Gear will supply you with the highest quality products and services that you and your customers expect. *Experience the difference!*

**Call 530 885-1939 or visit
www.broachmasters.com**



Manufacturers of:

- Broaches**
- Spline Broaches
- Fine Pitch Gear Broaches
- Form Broaches
- Serration
- Bearings
- Shaper Cutters**
- Disk Shapers
- Shank Shapers
- Hex and Square Cutters
- Special Form Cutters
- Inspection**
- Master Gears
- Go-No Go Gages
- Posiloc Arbors
- "Quick Spline" Software



Made in USA

1605 Industrial Drive
Auburn, CA 95603
Phone (530) 885-1939
Fax (530) 885-8157
Web:
www.broachmasters.com

um and very fine grits in 4 1/2" and 5" sizes.

The Fusion Flap Disc is suitable for use on stainless steel and aluminum. Applications include removing welds, light burs, and surface roughness on all types of fabrications including chassis, vessels and handrails. The discs are sold in packs of five with a retail price

of \$59.95.

For more information:

Rex-Cut Products, Inc.
960 Airport Rd.
Fall River, MA 02722
Phone: (800) 225-8182
E-mail: bobc@rexcut.com
Internet: www.rexcut.com



Your company's products are unique. From the design of a complex component to a completely assembled machine, you need solutions specifically designed for you.

Now—more than ever—Clifford-Jacobs is ready to meet your specific forging needs. We are a leader in quality low-to-medium production run forgings up to 30 inches in diameter and/or 50 inches in length. And we've expanded, adding new CNC equipment to our on-premises die-shop, doubling our die-steel and raw material inventory. We've added crucial equipment and increased staff in all shop departments to serve you better and faster.

Call 217.352.5172 today and see how Clifford-Jacobs is **ALL GEARED UP** to serve you.

CLIFFORD-JACOBS FORGING

P.O. Box 830 Champaign, IL 61824-0830
217.352.5172 fax: 217.352.4629
sales@clifford-jacobs.com



CLIFFORD-JACOBS.COM ■ ISO 9001:2000 CERTIFIED

Philadelphia Gear

INTRODUCES CORE ONLINE

Continuous Oil Rescue Equipment (CORE) filters, launched as an alternative to traditional barrier filtration techniques by Philadelphia Gear, are now available for purchase online at www.philagear.com. According to the company's press release, the CORE filter boasts a three-dimensional storage capacity that allows for longer periods of operation.

Inside the cast aluminum housing is an assembly of five magnets, each surrounded by a set of steel flux plates. "Collection zones" are machined into the plates to prevent oil flow restriction. These plates create magnetic fields that strip ferrous metal contaminants out of the lubricant while maintaining pressure.

“The simplicity of the CORE filter online sale offered Philadelphia Gear a unique opportunity to do business with our customers in a whole new way—the Internet,” says Carl Rapp, Philadelphia Gear’s chief executive officer. “CORE was a perfect fit for an online ordering system because its price point allows customers to purchase the filter out of their discretionary operating maintenance budgets.”

For more information:
Philadelphia Gear
King of Prussia, PA
Phone: (800) 766-5120
Fax: (610) 337-5637
Internet: www.philagear.com

The LZ90-360 offers a clamping range with a minimum of 90 mm and a maximum 360 mm, the LZ150-420 from 150 mm to 429 mm and the LZ110-500 has a range from 100 mm to 500 mm.

The steady rests maintain the integrity of shaft or bar workpieces that tend

to bend or deflect under unstable cutting loads. The rests feature three roller levers with curved surfaces that arc towards the workpiece at a 120-degree angle. According to the company’s press release, this design reduces the size of the housing and provides a consistent, uniform clamping force.

continued

LMC

INTRODUCES LARGE ATLING STEADY RESTS

Designed to fit any CNC or conventional lathe, the LMC Atling self-centering steady rests feature three new models—the LZ90-360, LZ150-420 and LZ110-500.



Standard Or Custom Parts From A Single Source

68,000 Drive and Automation Components
Ready-to-Deliver

GEARS & GEARBOX ASSEMBLIES

- Precision & Commercial Quality
- AGMA & DIN Specs.
- Fine to Medium Pitch
- Prototype & Production quantities available.
- Gear Types: Spur, Miter, Bevel, Worm & Worm Gear, Rack & Pinion, Helical & Internal.
- Gearheads, Speed Reducers & Differentials
- Inch & Metric
- RoHS Compliant
- In stock, modified or made to your specifications.

3D CAD | eSTORE
available at www.sdp-si.com



Our experienced team of engineering and manufacturing experts are ready to work for you.



FREE
Inch & Metric
Catalogs

SDP/SI
Stock Drive Products/Sterling Instrument

ISO 9001:2000 Registered
Sterling Instrument AS9100B Registered

Tel. (516) 328-3300 | Fax (516) 326-8827 | www.sdp-si.com

For more information:

LMC Workholding
 P.O. Box 7006
 1200 West Linden Ave.
 Logansport, IN 46947-7006
 Phone: (574) 735-0225
 Fax: (574) 722-6559
 E-mail: info@logan-mmk.com
 Internet: www.logan-mmk.com

Stafford

OFFERS MOUNTING
 COLLARS WITH
 MULTIPLE BORE
 DESIGNS



RESIDUAL STRESS MEASUREMENT

Take advantage of PROTO technology—the fastest residual stress measurement systems that consistently out-perform the competition. Residual stress affects crack initiation, crack propagation, stress corrosion cracking, distortion and fatigue life. PROTO has the accuracy, speed and technology to keep your product perfect right from the start.



EXCELLENCE IN THE FIELD AND IN THE LAB

PROTO'S comprehensive line of laboratory and portable residual stress measurement systems ensure the best system is available to successfully perform RS measurements on your components.



RESIDUAL STRESS CHARACTERIZATION AT FAILURE CRITICAL LOCATIONS... WHERE IT COUNTS

Improve quality, enhance fatigue life, and ensure that surface enhancements are being applied correctly. Even complex geometries such as those found on gears can be easily measured using our systems. Ensure that your components perform to their maximum potential with residual stress measurement.

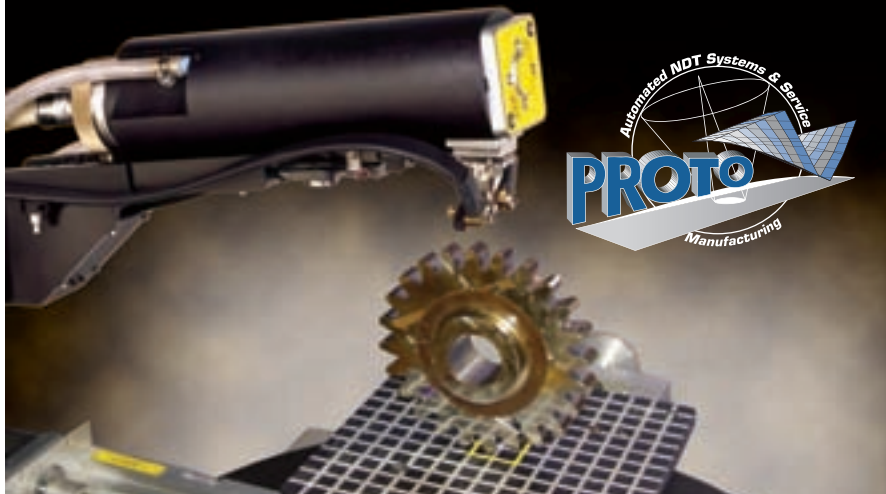

Stafford recently introduced a universal mounting collar that can be supplied with different bore designs to fit rail mounts and other devices. The mounting collars have a flat surface with a countersunk and tapped hole that allows it to be mounted to a flat surface or onto a rail or shaft.

According to the company's press release, the collars feature smooth-, hex-, square-, threaded-, or keyed-bores to eliminate the need for drilling holes or welding. The mounting collars are suitable for applications in machinery, power transmission, packaging, conveyors, laboratories and consumer products. The universal mounting collars are priced at \$11.90 each.

For more information:

Stafford Manufacturing Corporation
 P.O. Box 277
 North Reading, MA 01864-0277
 Phone: (800) 695-5551
 Fax: (800) 649-5101
 E-mail: jswiezynski@staffordmfg.com
 Internet: www.staffordmfg.com

(800) 965.8378 (519) 737.6330 protoxrd.com xrdlab@protoxrd.com

Ultrasonic Tanks

AIM TO CLEAN-UP INDUSTRIAL MANUFACTURING

Ultrasonic tanks by Omegasonics assist in the process of toxic parts cleaning in all industrial machining applications. According to the company's press release, ultrasonic tanks can reduce the time and labor necessary to clean most industrial equipment.

Instead of personnel scrubbing and washing, users can place the parts directly in the tank. The ultrasonic tanks will clean through cracks and crevices typically missed using conventional equipment. They boast a filtration package as well as an accessible operator interface.

Omegasonic tanks have been utilized for military aircraft components, optical encoders and plastic injection molding. Bud Greener, manufacturing engineer at Eaton Aerospace, recently implemented the tanks at Eaton's Jackson, Michigan plant.

"Prior to the ultrasonic system, we cleaned tubes manually," says Greener. "Now, we put them into the cleaning systems, adjust the settings and walk away to do something else while the parts are being cleaned."

Ultrasonic tanks utilize environmentally friendly cleaning solutions, heat, water and ultrasonic sound waves for the cleaning process. The liquid can reach areas unable to be cleaned by human hands or other devices.

For more information:

Omegasonics
330 E Easy St. #A
Simi Valley, CA 93065-7523
Phone: (805) 583-0875
E-mail: frankp@omegasonics.com
Internet: www.omegasonics.com

ONLINE

Visit

www.geartechology.com
for the latest Product News

COMTOR SPLINE GAGES

Rugged, Reliable, Repeatable

...For 75 Years!



For all your gaging needs,
Comtorgage it!

Analog Dial or
Digital Readout



- Applicable to Spur and Helical Gears!
- Gage the Part at the Machine!

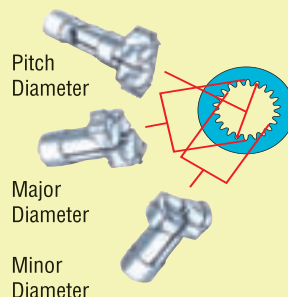

Internal or External Spline Measurement Made Easy!

Still using micrometers and pins method?

Comtor Spline Gages make pitch diameter measurement quick, easy and accurate!

comtorgage®

Comtorgage Corporation

(Since 1928)

Ph: (401) 765-0900 Fax: (401) 765-2846

www.comtorgage.com

Triple A Hobbing

A¹ Shortest ever hobbing time

A² Best ever accuracy

A³ Best ever warranty

Richardon proudly offers the probably best ever offered Gear Hobbing Machine for gears up to 40" in diameter, .8 DP, 50" face.

Featuring:

Powerful, backlash and wear free operating direct torque motor table drive (no worm gear), for unmatched hobbing accuracy. 50 rpm max. table speed for high-speed hobbing. Preloaded axial/radial table bearing, lifetime lubricated. 50 horse power hob spindle motor for the best carbide and other hobs. Solid, one-piece heavy cast iron, vibration absorbing machine bed, for high tool up time. Hardened and precision ground long life V- ways for all movements. Extensive software package for different hobbing modes, latest Siemens controls and electrics.

RICHARDON

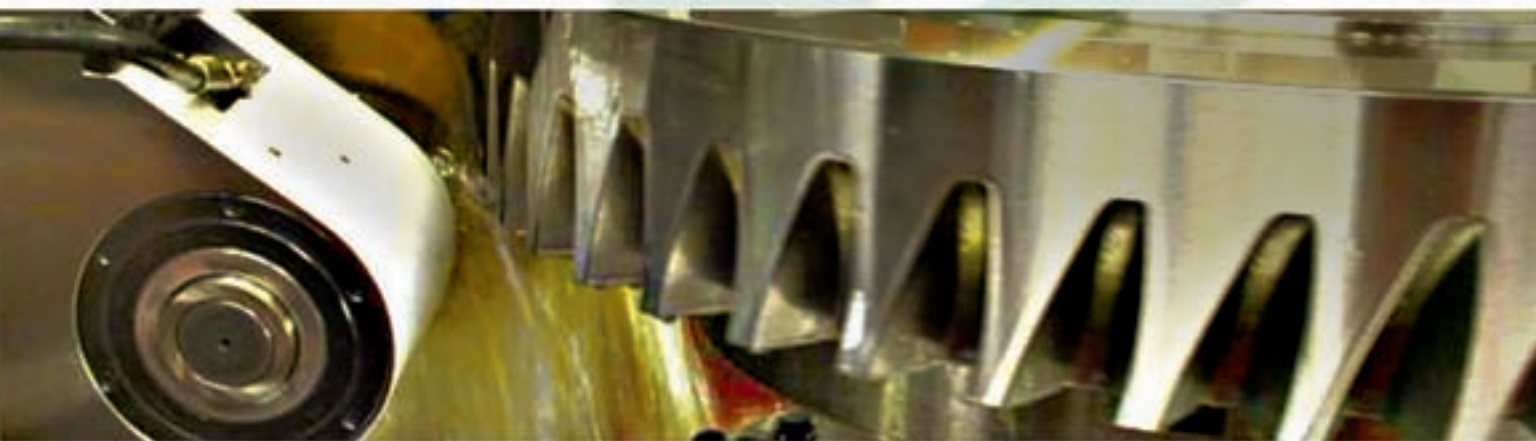

Cut your expensive grinding times with an already accurate gear before grinding.

Richardon offers turn key installations and operator training included. 2 years of warranty for the machine (one year for electrical parts) and 5 years of warranty on the table drive and bearing and all mechanical Richardon components*, Siemens service contract available upon request.

Richardon GmbH is a first generation, privately owned corporation with a passion to built first class hobbing machines. For special requests: talk to the owner.

For more information:
Please call or write to
Richardon GmbH
71573 Allmersbach, Germany
info@richardon.de
www.richardon.com

*Richardon GmbH conditions of sale apply

The Future is Now for U.S. Wind Turbine Industry But Who's Positioned to Meet It?

Jack McGuinn, Senior Editor

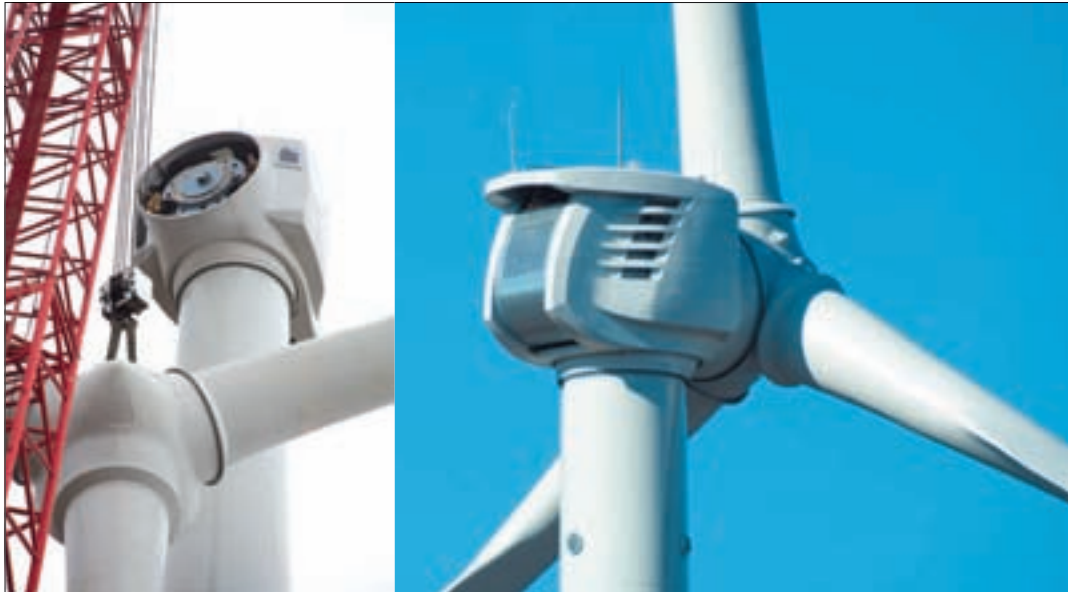

Behemoths like this Clipper Windpower 100MW Endeavor (left) turbine installation in Iowa and the 2.5MW Liberty—the largest in the U.S.—require like-sized components, particularly gearboxes, rotors and bearings. Photos courtesy Clipper Windpower.

The United States' long-held dream of energy independence—as in cheap, clean, free of overseas extortion and renewable energy—could very well be realized in part by the country-wide development of wind turbines. Indeed, figures now show that the U.S. leads the world in annual wind turbine installations; by most projections, that growth will only increase over the next 10 years. And those turbines require gears—big ones; and gearboxes, cast housings, custom large-scale bearings and ongoing maintenance and component replacement. And so one could reasonably expect that American gear, bearing, gearbox assembly and other related suppliers are racing to line up for their place at the payoff window.

Not quite. And not yet.

That's because aside from other significant issues—mostly political—the open secret is that fast-track, domestic wind turbine development is hampered by significant supply chain and learning curve deficiencies. Whether it's turbine bearings, gears, gearboxes or the machines that make

them, there are significant lead time durations—up to two years in the case of grinders and hobbors delivery—that current and would-be players in this market must deal with on a daily basis.

Demand is there, but supply is lacking. “I would say that the desire or pace of the demand for wind energy is growing more quickly than the manufacturers of gears and bearings (for example) can grow at,” says Bob Gates, senior vice president of commercial operations for CA-based Clipper Windpower (and current American Wind Energy Association [AWEA] president). “That would seem to connote that something is wrong, but not so,” he says. “Wind energy demand is growing in part because of wind's environmental and energy security benefits, and consumers are simply wanting more and more of it.

“In turn, the growth is accelerating faster than the world's supply chain is able to make the required equipment and machine gears, and to forge the

steel necessary to supply the demand. So, in essence, the industrial infrastructure ramp-up curve is not quite as steep as the growth and awareness of climate change.”

Compounding things, says Gates, is that extremely high-grade, forged steel is required for the bearings designed for wind turbines, adding that “The ring that the bearings are machined from is 10 or more feet in diameter, and throughout the world the capacity to make bearings of this scale is limited.”

Beyond that, he adds, “The same large-scale material is used in fabricating the pivot bearings in virtually every new construction crane fabricated to facilitate the building booms taking place in China and the Middle East. In part, the fabrication of these cranes is consuming the bearing material, limiting the availability of supply to wind turbine manufacturers. In terms of priority, since the construction boom began prior to the large demand for wind in the U.S., available materials and fabrication capability were, for the most



This look at the 330,000 sq. ft. Clipper Windpower plant in Cedar Rapids, Iowa provides a sense of proportion relative to the space requirements necessary for component production and assembly. Photo courtesy of Clipper Windpower.

part, committed prior to the recent large wind energy surge in the U.S.”

Cam Drecoll, CEO of Brad Foote Gear Works in Cicero, IL (recently purchased by WI-based Tower Tech Holdings) also cites bearings as the major bottleneck right now.

“The critical item now is bearings,” he says. “I think the gears and castings are catching up, but the bearings are lagging. So over the next two years it’s probably bearing production that will limit the growth of turbines.” Again echoing Gates, Drecoll points out that the growth “is not only explosive in the wind turbine sector, but [the demand for] large bearings for the mining industry is peaking for the first time in 20 years. Oilfield equipment is peaking—it’s a perfect storm—all the large installations are putting a strain on the large bearings manufacturers.” (Editor’s note: A comprehensive feature on bearings used in wind turbines will appear in the February issue of *Power Transmission Engineering*.)

Charlie Fischer, VP/Technical for AGMA, points out that “Because of the size and wind turbine stipulations on a gear drive of this type, you have to have high-power-density gearing in them, which leads to having a good handle on the material used in the gear elements and

the manufacture of them. And these are things that slow down the process.”

Going to the source. If you can find one. Patrick O’Keefe is a CA-based, global sourcing and component buyer for Mitsubishi Power Systems America (MPSA). As one in the front trenches of the supply chain battle, he brings particular insight to the problems and possible solutions facing turbine manufacturers. And while following his recommendations may be beyond the reach of the smaller suppliers, they nevertheless ring true.

“Manufacturers need to invest in the large gear grinding equipment, on-site heat treating and testing equipment,” he says. “If a supplier can handle most of these functions in-house, then they are valuable to the industry. There are some leaders and some followers that know what needs to be done, but the decision has to be made now for investment and expansion to meet the demands of wind.”

A pretty tall order, to be sure. (And yet the same can be said of the politicians in Washington, but more on that later.)

As the North American distributor for Hofler, Great Lakes Gear Technologies’ Ray Mackowsky is taking advantage—along with Clipper, Brad Foote and a few

select other domestic companies—of the rapid growth of the U.S. wind industry. But aside from the growing need for more and more of the types of machines he sells—a good thing, obviously for machine tool manufacturers—he has in his cross-country travels taken notice of other issues beyond growth patterns relative to wind energy. One is a dearth of experience and capabilities in the manufacture of the gearing, castings, etc., for turbines.

“When the market started up here about four years ago, I was asked by one of the leading wind turbine manufacturers to identify good sources for components relative to wind turbine development in the United States, he says. “I ran around the country for six months and found out that almost no one out here is capable of doing what the Europeans were already doing with gear manufacturing. You could count the players on one hand, and of those, they had a real reluctance to invest any further” in the necessary machine tools. “Some weren’t really interested because they weren’t sure it (wind energy) was going to stay. Four years later, it’s a different story.”

Capabilities first; sales second. But with that, says Mackowsky, has come a degree of circular-firing squad, chicken-or-the-egg mentality between the major turbine installers and Johnny-come-lately, wannabe suppliers. As usual, it’s all about “show me the money,” or more accurately—capability.

“What the OEM wind turbine installers (GE Energy, Siemens, etc.) are saying to suppliers is, ‘Hey, you have to put your money where your mouth is first before we give you the business.’

“Today, the guys who the vision and invested early into it, like Brad Foote for one, which has acquired 20 Hoflers in the last several years, they’re now a major player in the wind turbine industry today.”

At NY-based Gleason Corp., another major supplier of specialized machinery for wind turbines, they’re taking a somewhat less sanguine view of the domestic market, as opposed to the international market.

“Most of what we’ve seen has been in Europe and Asia,” says Alan Finegan, Gleason marketing director. “The demand for large hobbing, shaping and grinding machines has outpaced anything that we

expected. We are doing some expansion in capacity and shifting some production to accommodate that demand. Most of these large, cylindrical gear machines are made in our Gleason-Pfauter plant in Ludwigsburg, Germany. (Ed.—Please see our sidebar on page 37 to learn how Gleason has changed to meet the needs of the wind turbine industry.)

Finegan, too, has thoughts on why Europe is ahead of the curve regarding the capabilities necessary for turbine componentry, and therefore have more supply in the pipeline.

“The European market is more mature in this industry and places a greater value on technology, which has really fueled our sales in the market. The U.S. market has historically been more price-sensitive, but we are starting to see buyer behavior change, where greater value is being placed on machine accuracy, repeatability and range of capabilities. In fact, we sold a record number of hobbing, shaping, grinding and inspection machines in the North American market in 2007.”

Proper tools—and investment—for the proper job. Whether that translates into a view that the technology quotient is higher in Europe than here is fodder for further debate. But there is no disputing that capital investment in turbines has traditionally been greater in Europe than here. In this arena, equipment rules, regardless of expertise.

“I think there’s a couple of reasons for that,” says Fred Chase, a veteran supply chain consultant to the industry and an AWEA presenter at this year’s Gear Expo Solutions Center. “The technology of making gears today has gone to another level, not that they couldn’t be done (here) in the past, but it was just a few shops. Today the production gears for a turbine gearbox have created a tremendous demand for technology, and I think that the American gear industry in general is not up to that standard. And I think it’s primarily equipment-based rather than technology-based.

“It’s purely just a decision-making process over whether to make the capital investment to do it. The message has to get to them (manufacturers), and that’s what I was trying to convey at Gear Expo—that there’s a market out there in great need. But in order to take part in that market you’re going to have to make



The gearboxes and gears used in today’s wind turbines are some of the most technologically advanced in the world. Finding skilled designers and workers to make them continues to be a problem for the industry. Photo courtesy of Clipper Windpower.



This Höfler Rapid 2600 gear grinder is one example of the specialized machinery necessary for wind turbine gear production. It can tooth grind gears up to 102” in diameter and weighing up to 20 tons. Placement of the 92,000-lb. machine requires a sunken foundation of 350 cubic yds. of reinforced concrete. The base of the foundation is supported by 12 auger cast pilings sunk to a depth of 50 ft. Photo courtesy of Seattle Gear Works.

the capital investment for updated grinding and cutting equipment.”

But even if the spirit—and pocket-book—are willing, the supply chain is unforgiving. Just ask Sterling Ramberg, vice president of sales and marketing for WA-based Seattle Gear Works. In this case, it’s not all about the money, but more like the old saying, “My kingdom for a horse.” Or a hobber, for example.

“Ramping up production as a gear maker is something—even if you’re will-

ing to commit all the resources—let’s say you don’t have to go to the bank, which we have to do to buy a machine,” he says. “You don’t receive shipment of these essential machines for up to two years. One of our grinders, a 2.6-meter gear grinder, is a unique piece of equipment in the wind turbine industry to do various components. It took two years to get the machine from the time we ordered it. Two years.”

Ramberg’s company is a domestic

leader in the aftermarket maintenance, repair and replacement of OEM turbine gearbox gear sets. And that activity in itself is a burgeoning market here, but with few domestic players thus far. Which, as stated, is not surprising—if not disappointing—given the investment required.

“These aren’t vanilla gears,” says Ramberg. “The cleanliness of the steel is important, the heat treating is important in that it must be done right, and then the finishing, which requires very special and

expensive grinding equipment in order to put all the bells and whistles into the geometry that these require.

“And so there’s a demand from the major OEMs that produce these gearboxes. And then when they go haywire in a very demanding environment, that’s an issue. Where are they going to send these things for repair? There’s really only a handful of people in the country that have the skills to be able to deal with these higher-end products that wind turbine gearboxes are.”

Who will make tomorrow’s turbines? And that leads to another problem facing players in the wind turbine business—the all-too-familiar state of the country’s manufacturing workforce. Anyone remotely involved in manufacturing knows that the dwindling number of skilled gear designers, engineers and tradesmen has been a drag on continued growth. We’ve all heard the same refrain—What’s the point of having a two million dollar machine on my floor if I can’t find anyone to run it?

“It’s a problem,” affirms Clipper Wind’s Gates. “When I visited some of our suppliers, one of the observations was, ‘You don’t have many younger people here; in 10 years half of your labor force could be gone.’ And they said, ‘You’re right; that’s a real problem.’ I saw that half of their signs were in Polish, and asked, ‘Can’t we import people from Poland?’ And they said, ‘Don’t get us started on immigration policies. We can’t bring in skilled workers from Poland.’”

Says the Gear Works’ Ramberg, “Who’s qualified to run these machines in this country for so many years? We’re trying right now to hire people and it is very, very difficult. We have to train people in-house and then maybe by the time you get someone trained or close to being worth anything—and you’ve been paying them to go to school—they have an issue or a problem and then leave.

“Everyone recognizes that there’s a future in this (market) so people are building their gear making skills. Countries like China and India, they’ll have an engineer getting three bucks an hour. Wouldn’t that be luxurious—to have a mechanical engineer to run your gear machine?”

The industry’s workforce may be on life support, but is not flatlining just yet. At Brad Foote, Drecoll faces the same problem in the Chicago area, but seems to be making some headway. For him, as with others, it’s not finding able workers, but training them that matters most.

“There are no qualified tooth grinders. We now have 30 tooth grinders, but prior to this I’d say there were 30 qualified tooth grinders in all of Chicago. So you can’t go out and say, ‘I’m going to find qualified tooth grinders.’ You have to train someone to get to that level.”

To that end, Drecoll is a firm believ-



<<< NEW MACHINING CAPABILITIES >>>

LEADING TECHNOLOGY FOR ECONOMICAL GEAR GRINDING.

Riverside Spline & Gear is proud to announce its latest addition arriving this November, 2007. A new 9000 sq. ft. gear grinding facility complete with cmm gear analyzing, magnetic particle inspect, and available nital etch inspection. This facility will be home to our new Hoffer Rapid 900 gear grinder. This machine offers the latest in form grinding technology. With AGMA class 14+ capability,

and on board gear inspection you can assure your gear will meet your design specifications. Come visit us at Gear Expo 2007 and find out why many refer to us as their job shop.

EXTERNAL GEARS	
Gear diameter	50 - 1000 mm
Center distance above table	360 - 1360 mm
Axial stroke (max)	650 mm
Helix angle	+45° ~ 90°
Module	1 - 25 mm (extendable to 34 mm)
Profile height	41 mm (extendable to 60 / 80 mm)
Grinding wheel width	60 mm (extendable to 90 mm)
Grinding wheel diameter	400 mm
Table load	3000 kg

INTERNAL GEARS	
Workpiece diameter	230 - 950 mm
Face width	280 mm
Grinding wheel diameter	200 - 110 mm
Grinding wheel width	30 mm





PO. Box 340 | Marine City, MI 48039
P: (810) 765.8302 | F: (810) 765.9595
valerief@splineandgear.com

splineandgear.com

ISO 9001:2000 Certified

er in AGMA's various online training courses.

"Those courses are very good, and we require all of our people to take them so they know the (gear terminology) we're talking. So when you describe a lead or involute, they know what the heck you're talking about. Our managers help them learn online what a gear is, and then we take that to the shop floor and show them how to use the machines."

Bottom line, what makes the lack of investment and skilled workers for the wind turbine industry even more galling is the fact that projections for continued, accelerated growth domestically are practically off the charts. But like an aircraft carrier doing a 180 degree turn, it will take the industry some time to better position itself. OEMs such as GE Energy are poised to meet the continuing demand, forecasts to the contrary.

Most forecasts just hot air. "When you look at forecasts for the wind industry, if you go back a couple of years and look, you realize that they're always wrong and too conservative," says Sean Fitzgerald, a GE Energy 1.5 MW platform leader. "We've seen positive demand in the last couple years, and the PTC (production tax credit) was extended last year for two more years, which is a good signal for the domestic wind industry. But as you look out, the PTC is set to expire in 2008, and the fact of the matter is we have very strong orders for 2009, an indication that customers see this as a longterm industry and growth opportunity."

Fitzgerald says GE has increased its output by five times since 2002, an "incredible," if unsustainable rate. But he adds, "This is absolutely a rapidly growing business for GE, and we've added a lot of resources. If you look at renewables, wind is the most viable option right now. If you want to increase renewable percentages, wind is where you have to go in the foreseeable future. It can be a staggering growth industry for quite some time."

Working at Mitsubishi at this time, says O'Keefe, "is personally exciting, to be at the forefront of a market that has an extreme growth potential. It's good to be with a global leader like Mitsubishi in the wind turbine arena and the U.S. market at a time when the U.S. market has tremendous demand and potential."

Adds AGMA's Fischer, "Booming

is putting it mildly. It's really exploded over the last three years."

Before we leap to assign blame exclusively to the manufacturers of these critical components and machines for the shortfall—which is inaccurate—the case is easily made that it is this country's late-to-the-dance mindset regarding renewable energy that has been the major impediment to continued growth.

Political will needed. Nurturing and facilitating domestic wind turbine growth is a challenge that begins in Washington,

D.C. and extends to the state level, with the latter being the most aggressive. Consider, for example, the PTC's importance to long-range planning and investment on the part of U.S. OEMs and suppliers. Every time the tax credit comes up for renewal, it becomes a political football between the two major political parties. The fact that it is ultimately extended every time does not mitigate the fact that the nation's capitol is decidedly behind the curve, and certainly more so than suppliers. For example, Congress

TAKE A BITE OUT OF YOUR GEAR COSTS WITH TEETH LIKE THESE.



Are you interested in reducing your gear costs while increasing their quality? Presrite hot-forges intricate gears to net and near-net shapes, so little or no hobbing is required.

We've invested millions to save you money and improve the performance of the gears you buy. Our dedicated gear-forging facility is equipped with a state-of-the-art gear lab, high-capacity presses, and the latest in sophisticated machinery.

See why customers from a wide range of industries and countries come to Presrite for forged gears. Contact us now for more information or a quote.

Weight Savings — As a blank, this large spur gear weighed 55 lbs. As a forged tooth gear with 1 millimeter of stock on the tooth profile for hobbing, it weighs just 37 lbs.



© 2006, Presrite Corporation

PRESRITE NEAR-NET GEARS GIVE YOU THE STRENGTH OF A FORGING WITH LITTLE OR NO MACHINING.



ISO 9001:2000 TS 16949:2002

Presrite Corporation
3665 E. 78th St. • Cleveland, OH 44105
Phone: (216) 441-5990
Fax: (216) 441-2644

We're as NEAR as the NET! Visit our Web site at www.presrite.com.



Ground Gear Quality At Shaved Gear Prices

The Gleason® 245 TWG Gear Grinder offers fast, accurate and economical solutions.

Complementing Niagara's full range of CNC and electronic gear grinders is the Gleason 245 TWG, High Speed Threaded Wheel Grinder. This latest technology in high speed production grinding will meet your most demanding needs on **PRICE**, on **QUALITY** and on **TIME**.

- Eliminate process related deviations and heat treat distortion
- Maintain critical size consistently
- Eliminate undesirable excitations via direct drives
- Affordable hard finishing using unthinkable metal removal rates
- Optimize contact and load carrying characteristics via algorithmic software

Contact Niagara Gear and put our world class, precision gear grinding team to work for you today.

1-800-447-2392

Fax: 716-874-9003

e-mail: info@niagaragear.com

www.niagaragear.com

941 Military Rd., Buffalo, NY 14217



finally passed a bipartisan energy bill in December, and there was quite a bit of mutual backslapping and logrolling going on. Sure, there were good, long-awaited things in the bill, such as new CAFE standards for cars and light trucks, and a requirement for the production of 36 billion gallons of renewable fuels by 2022, among other things. But guess what was stripped from the bill in the face of a threatened veto by the White House? You got it—the stipulated renewable electricity standard and incentives for wind and solar/energy.

Regarding the PTC, says industry consultant Chase, “Historically, they’ve allowed it to lapse and usually it takes them anywhere from two to six months to reinstate it. And what that does to the industry is, it stops it; literally stops the manufacturing. The OEM developers are uncertain over when and what’s going to happen, the manufacturers don’t want to invest in building wind turbines

on speculation. So everything comes to a standstill and the problem with that is, when the credit is renewed, the tap doesn’t just get turned back on. It takes a year to wind it back up again.” (See our story on jobs creation and renewable energy standards at the state level on page 32 of this issue.)

Perhaps Mitsubishi’s O’Keefe, in referencing Charles Reich’s prophetic work of non-fiction from 1970, sums it up best.

“The ‘greening of America’ is coming, and this is a key issue for both (political) parties in the coming 2008 election. And as the demand for reduction of greenhouse gasses, cleaner alternatives and scarce natural resources globally continues, wind becomes a viable solution.”

For more information:

American Gear Manufacturers Association (AGMA)

500 Montgomery Street/Suite 350

Alexandria, VA 22314-1560

Phone: (703) 684-0211

Fax: (703) 684-0242

E-mail: tech@agma.org

Internet: www.agma.org

American Wind Energy Association

1101 14th St., NW-12th Floor

Washington, DC 20005

Phone: (202) 383-2500

Fax: (202) 383-2505

E-mail: wind@awea.org

Internet: www.awea.org

Clipper Windpower

6305 Carpinteria Avenue, Suite 300

Carpinteria, CA 93013

Phone: (805) 690-3275

Fax: (805) 899-1115

E-mail: mgates@clipperwind.com

Internet: www.clipperwind.com

The Gear Works Seattle Inc.

500 Portland St.

Seattle, WA 98108

Phone: (206) 762-3333

Fax: (206) 762-3704

E-Mail: tgw@thegearworks.com

Internet: thegearworks.com

GE Energy

www.gepower.com

Gleason Corporation

1000 University Avenue

P.O. Box 22970

Rochester, NY 14692-2970, USA

Phone: (585) 473-1000

Fax: (585) 461-4348

E-mail: sales@gleason.com

Internet: www.gleason.com

Great Lakes Gear Technologies, Inc.

8755 Ronda Drive

Canton, Michigan 48187

Phone: (734) 416-9300

US & Europe cell: (313) 506-3381

E-mail: rmackowsky@greatlakesgeartech.com

Internet: greatlakesgeartech.com

Mitsubishi Power Systems Americas, Inc. (MPSA)

Patrick O’Keefe, C.P.M., Buyer-Global Sourcing

100 Bayview Circle, Suite 6000

Newport Beach, CA 92660

Phone: (949) 856-8400

Fax: (949) 856-4481

E-mail: pokeefe@mpshq.com

Internet: mpshq.com

Tower Tech Holdings, Inc.

J. Cameron Drecoll

47 E. Chicago Avenue/Suite 332

Naperville, IL 60540

Phone: (630) 637-0188

Fax: (630) 637-8472

E-mail: cdrecoll@bradfoote.com

Internet: www.towertechholdings.com

(UNDER CONSTRUCTION)



CONTROL

OVER EACH CRITICAL PROCESS

ALLOWS US TO MEET YOUR EXACTING STANDARDS – AND OURS.

Let our team of highly skilled employee-owners use the latest technologies, processes, and equipment to guide your specifications through the entire manufacturing process.

GRINDING

Overton Gear produces custom Spur, Helical, and Bevel Gears that deliver on all of your performance requirements. Fifteen state-of-the-art Gear Tooth Grinders provide the versatility to perform both generative and form grinding, and we're always adding new capabilities. Our newest: a 2 meter tooth grinder with both internal and external grinding capability.

GEAR INSPECTION

Trained technical staff using the best equipment available ensures each gear meets your quality standards.

HEAT TREAT

With a 10,000-square-foot expansion of our heat treating facility, Overton Gear provides unrivaled capacity and capabilities.

visit WWW.OVERTONGEAR.COM

100% EMPLOYEE OWNED

530 Westgate Drive • Addison, IL 60101 • info@overtongear.com • (630) 543-9570



OVERTONGEAR
PROCESS-DRIVEN PRECISION



NSF

REGISTERED TO ISO 9001

Well-Paying Manufacturing Jobs are Blowing in the Wind

And State Governments are Racing to Harness Them

Jack McGuinn, Senior Editor



A look at an upper-gearcase component being premachined at Advance Mfg.



An array of gearcase components in Advance Mfg.'s staging area. To keep up with the demand, the company has grown its workforce by 20 percent in less than two years.

Lamentations continue—legitimately so—over the second-citizen status of manufacturing in the United States. The need undoubtedly continues for renewed support by government and educators for making things here once again. But in one manufacturing sector, the above take on the state of things is *so* last-century in its thinking relative to what is going on today.

That would be the manufacture, maintenance and components replacement of wind turbines that are beginning to sprout like wildflowers right here in the USA. And while some sections of the country are more conducive than others to wind turbine development and usage—the Midwest, West and Southwest, for example—there is also a ripple effect in terms of jobs creation from which neighboring states can benefit.

From coast to coast—from Texas to Iowa, the Dakotas to Ohio and Michigan, and from New York to California—these and other states are scrambling to attract wind turbine energy companies, OEMs and suppliers for two principal reasons—economic development (and re-development in many cases) and JOBS. Well-paying, manufacturing jobs in the high \$40-k range and beyond. “Rust Belt”-designated states like Ohio, Iowa and Michigan are in some ways leading the charge in helping to develop the domestic manufacturing infrastructures necessary to the wind industry in this country. And indications are strong that they will continue in the role, with a number of other states joining them along the way.

Burnishing the Rust Belt. American Wind Energy Association (AWEA) executive director Randy Swisher was quoted in the Des Moines Register in

October saying that "Iowa has a base that's only going to grow as manufacturers like Siemens, Clipper Windpower and Acciona Energy attract component suppliers."

Wind turbines are comprised of approximately 8,000 components, and doing the math on how many workers are needed to make them on a steady basis is exciting to anyone yearning for a return of this country to manufacturing prominence.

Cleveland-based Advance Manufacturing—they make gearbox castings for turbines—is just one example of a veritable manufacturing renaissance. Since committing to devote almost half of its production to the turbine sector, says company president Herman Bredenbeck, "Our employment has increased by probably 20 percent over the last 12–15 months. And we are going to be adding one other large piece of equipment to support the business, so (hiring) won't be stagnant. I think (turbines) are a great opportunity for all manner of companies relative to the metalworking trade. And I think Cleveland could stand some of that luck."

But, of course, more than luck is required. Economic development and the employment opportunities that derive from it cry out for—dare we say it?—vision. Determining that wind power is here to stay and looking beyond the horizon are what's been keeping Paul Gaynor, president and CEO of UPC Wind, busy in the re-development of the shuttered Bethlehem Steel Works in Lackawana, NY. Appearing on *engineer-live.com* recently, he stated that, "Where Bethlehem Steel once supported an earlier industrial revolution, today the Steel Winds project is bringing new jobs and clean energy technology to the Lake Erie region."

In the same report, Lackawanna Mayor Norman Polanski—who like his father before him once worked at Bethlehem—relates that the Steel Winds project has led to the opening of 12 new businesses and the first new hotel in over 100 years.

"Lackawana was a leader in the industries of the 20th century, and now claims a leadership position in this key energy technology of the 21st century."

Back in the Midwest, in Iowa and Ohio alone, aggressive efforts to lure

energy companies and turbine OEMs have led in the last two years to upwards of thousands of new positions paying as much as \$23 an hour, and to billions of dollars in economic development.

And in Michigan, one of the Rust Belt's poster children, Gov. Jennifer M. Granholm was quoted recently as saying that "Developing alternative sources of energy is critical for our nation in the 21st century, and it can mean thousands and thousands of jobs for Michigan residents. Our goal is to replace those lost manufac-

turing jobs in the automotive sector with jobs in this alternative energy sector."

And why not? States like Michigan, with a long manufacturing heritage and sound educational resources, are now poised—ironically enough—to be at the forefront in economic and jobs development in the booming alternative/renewable energy sectors. Who knows—perhaps wind power can even play a part in the rejuvenation of Detroit and its long-withered tax base. Good white collar jobs are certainly a part of turbine develop-

**INNOVATIVE,
DYNAMIC,
CREATIVE,
CHALLENGING.**

JOIN US!

Apache by
Boeing,
transmissions
by Purdy.



Immediate Opportunities in Challenging Aerospace Careers.

The Purdy Corporation is a leader in manufacturing flight critical Jet engine and rotor components including gears, gear boxes and transmissions for OEMs and the United States Government. Aerospace manufacturing opportunities offering stability, job satisfaction and growth are available in the following areas of expertise;

- Gear Management - Aerospace Manufacturing
- CNC Programming (Unigraphics) - Gear Box Housings, High Speed Machining,
- Gear Engineering - Process, Planning & Manufacturing
- Gear Machining - Spiral Bevel and Parallel Axis • ID/OD Grinding
- Gear Metrology • Gear Box Assembly and Testing

Excellent benefit and relocation packages.
An Equal Opportunity/Affirmative Action Employer.

**Take your career to a whole new level, contact us at
860.649.0000 Ext. 226 or e-Mail to finance@purdytransmissions.com**



THE PURDY CORPORATION
60 YEARS OF EXCELLENCE
www.purdytransmissions.com
586 Hilliard Street, Manchester, CT 06042, USA • Phone 860-649-0000, Fax: 860-645-6293





SEAMLESS ROLLED RINGS

- 20"-70" Diameters
- Carbon, Alloy & Stainless Steel
- Same Day Quotes

Fast...
2-3 Week Deliveries
*with material in stock

McINNES ROLLED RINGS

1-800-569-1420
www.mcinnesrolledrings.com
sales@mcrings.com

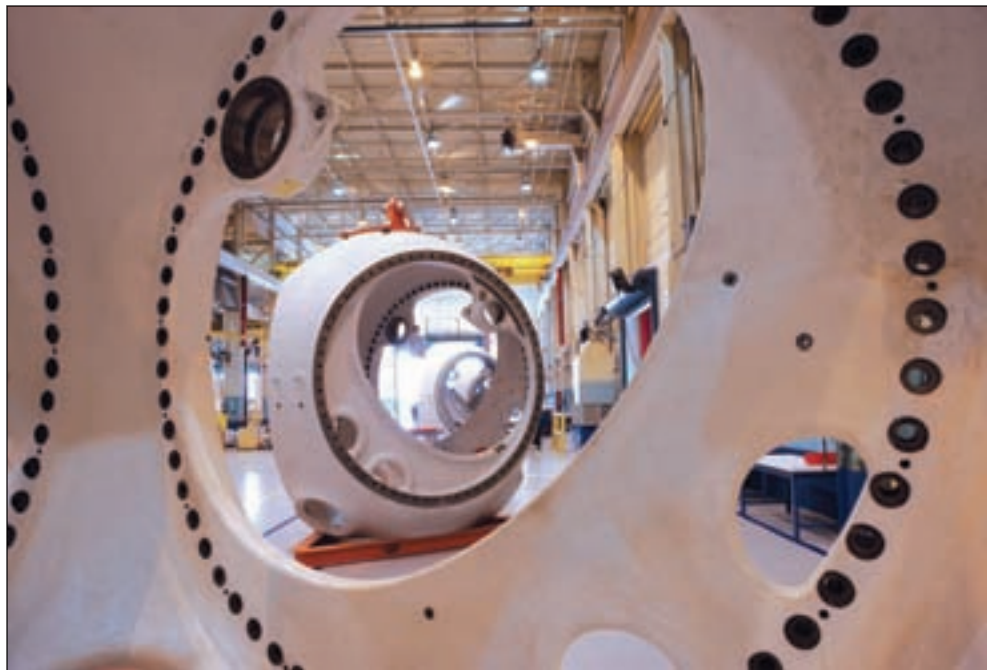

Just one of 8,000 components needed for wind turbines populating rural America's wide open spaces. Photo courtesy of Clipper Windpower.

ment and maintenance services, etc.

"One of the big things Michigan has going for it is the university base," says Ray Mackowsky, president of Great Lakes Gear Technologies. "It has some of the most notable universities in the country and a lot of research and funding money and endowments. The engineering base is huge and gear-savvy."

From cattle ranching to wind wrangling. Out west—South Dakota to be precise—wind power is gaining a headwind as well. The state, one of the windiest in the nation, is in line for development of several wind farms, and their contribution to the area's economy. Contingent upon continued energy tax breaks and incentives from the state and Washington, as well as the development of new transmission lines to deliver the wind-generated electricity to other states, South Dakota Senator John Thune believes that his state has the potential to deliver power "for 55 percent of the needs in the country." Unfortunately—and here is where the vision gene applies—the Bush Administration stripped proposed incentives and other perks for development of wind energy from the energy bill passed in December. But the potential for manufacturing jobs, where few now exist, remains.

Taken together, wind power development can be a self-sustaining industry and renewable power source for generations to come. Most predictions state that

wind power will ultimately account for 20 percent of the country's energy source. Beyond that, wind power can play a part in the redevelopment of some portion of the EPA-estimated 450,000 brown-fields blotting the country's maxed-out and abandoned manufacturing areas. This leads to new usage of and reinvestment in these properties, the resultant boost in local and state tax bases and not just good-paying manufacturing jobs, but scores of environmental cleanup projects as well.

But it is manufacturing jobs that matter most to anyone reading this—jobs making the gears, gearboxes, castings and custom bearings for wind turbines—to name just four of the those 8,000 turbine components that are desperately needed for further growth in our domestic wind power industry and renewable energy efforts.

And that can be a definitive win-win for all Americans, much to the chagrin of OPEC. ☉

Ingersoll **S-MAX** line



Engineered Specials

With the super strength & productivity of "S-Max"

- Complex, one-of-a-kind forms are possible
- Using the latest grades and geometries available
- Application concepts to match machine tool to appropriate tool design
- Extended tool life and performance with S-MAX sub-micron grade IN2005
- Global application support
- Constantly upgrading traditional tool designs to the latest efficiency

S-MAX



Member IMC Group
Ingersoll
Cutting Tools

Seen for the First time at the EMO 2007!

Profilator introduced the SCUDDING® process for green machining of internal and external gears

Please visit
www.geartechnology.com
to see
scudding video



SCUDDING® is a continuous cutting operation that can be defined as a process between gear-hobbing and gear-shaping. The relationship of the cutting tool and workpiece orientation can be compared the different gear cutting methods:

- Gear-Hobbing simulates a "worm drive"
- Gear-Shaping simulates a "spur drive"
- SCUDDING® simulates a "helical drive"

The SCUDDING® process can be used for a wide range of gear applications, such as:

- Involute gears (internal and external)
- Non-involute profiles on internal or external gears
- Non-symmetrical gears such as belt pulleys

Using a Wera Profilator REDUCES YOUR OPERATING COSTS and IMPROVES YOUR FLEXIBILITY:

REDUCE!

- Investment cost
 - Fewer machines required
- Floor Space
 - Fewer machines required
- Labor cost
 - Fewer machines required
- Energy consumption
 - Fewer machines required

SUPERIOR FLEXIBILITY

- Internal Gearing
- External Gearing



4630 Freedom Drive • Ann Arbor, MI 48108 • 734.973.7800 • fax 734.973.3053

www.american-wera.com

Winds of Change

How Gleason Corp. is Keeping Up With Demand

Mike Hayes, Hayes Marketing Services



It seems that nothing can hold back the power of the wind—unless, of course, it's the availability of rugged, reliable, specially designed gearboxes.

In a typical wind turbine, the shaft connected to the rotor enters the gearbox which converts the slowly rotating, high-torque power in stages into high-speed, low-torque power for input into a generator. Sounds simple enough. But unlike the average industrial gearbox, subject to predictably minor speed and load variations, wind power gearboxes are constantly exposed to wild swings in load pattern, putting tremendous pressure on the gears and bearings. In addition, many of these wind towers are equipped with a second gearbox, subject to perhaps even greater loads, used to continuously “yaw” the rotors so they're always aligned to face a constantly changing wind direction, thus ensuring an optimum share of the wind energy.

Many of these gearboxes will be operating out in the open sea, where the cost of repair—should a gear fail—is estimated at

10 times that of an onshore installation. Then, too, there is the issue of noise, particularly for installations onshore. Wind turbine manufacturers are under enormous pressure to produce quieter systems despite their increasing size. In fact, the wind power gearboxes, and the gears that go in them, are among the most specially designed, most sophisticated of any application, when you consider the need for reliability, efficiency and noise performance.

Gleason has supplied a complete range of machines and tooling for the production of wind power gears for many years. The industry's need for complete process solutions—hobbing or milling, shaping, grinding, inspection and the associated tools—for large (up to 5 meters) internal and external spur and helical gears, has caused Gleason to put into place a three-part global strategy to help the company meet unprecedented near-term and long-term demand for its largest machines and tools.

Adding Capacity and Reallocating Resources

The Gleason-Pfauter facility in Ludwigsburg is operating at record-high levels, with assembly underway on dozens of large hobbing, shaping and profile grinding machines, many destined for Hansen Transmissions' new wind power facility in Tamil Nadu, India. The addition of new assembly floorspace nearby, and a reallocation of resources within Gleason's global operations on the whole, have made it possible for Gleason-Pfauter to react quickly and effectively to current and future wind power demands.

Introducing New Technology

Many of Gleason's most recent product and technology innovations can be useful to manufacturers of large gears with complex geometry—typical of wind turbine gears.

• *Opti-Cut indexable insert tooling system.* Gleason's new family of gear gashing, shaping and hobbing cutters

Still Quiet After All These Years



For over 60 years, Arrow Gear has been meeting the toughest requirements of power transmission manufacturers.

We are widely recognized as a leader in the precision gear industry, and as a producer of high quality products that run smooth and quietly.

For more information on all that Arrow has to offer and how we can assist you with your gearing requirements, please call or visit our website—and learn why our gears are still quiet after all these years.

2301 Curtiss Street
Downers Grove, IL 60515
(630) 969-7640
www.arrowgear.com



is equipped with replaceable, indexable insert technology, making it economical for users to apply the latest carbide materials and coatings to operations, such as internal gear gashing, where solid high-speed steel cutters are generally used. With this system, users can run their machines at optimum feeds and speeds, taking precious minutes out of the machining cycle times and ultimately lowering total cost per workpiece.

- **Electronic Guide (ES) shaping capability.** Where shaping is required, Gleason offers its ES gear shaping machines. The ES technology eliminates the need for mechanical helical guides and the associated expense and long changeover time. ES technology improves productivity through the dramatic reduction in setup changeover time. Gleason's ES technology uses a proprietary CNC technique to electronically superimpose a twisting motion on the shaper cutter as it rotates. Input parameters, such as helix angle and defining the workpiece, are simply entered into a computer dialogue program, and the CNC controller calculates the necessary controlling motions automatically.

- **New profile grinding software.** Heat treatment is a vitally important gear processing step for wind power applications because of the need for optimum strength and high reliability. Wind turbine manufacturers have refined and perfected gear design and the associated heat treatment processing to ensure maximum performance under severe operating conditions. Unfortunately the heat treatment process often results in unwanted distortion. This makes finish profile grinding operations critical. Gleason-Pfauter profile grinders employ a suite of software features that can save production cycle time. *The Adaptive Process Control* software feature reduces the 'grinding of air' time typically wasted because the grinding wheel might not actually be making contact with the tooth flank in areas of the gear where heat treat distortion has "moved" the tooth away from its theoretically correct position. *Adaptive Process Control* detects when there is no contact between the grinding wheel and tooth flank during axial in-feed, and automatically increases the feed rate. This dynamic adjustment of the axial feed rate can reduce overall cycle time on a large gear by several minutes.

Get Your Addendum On!

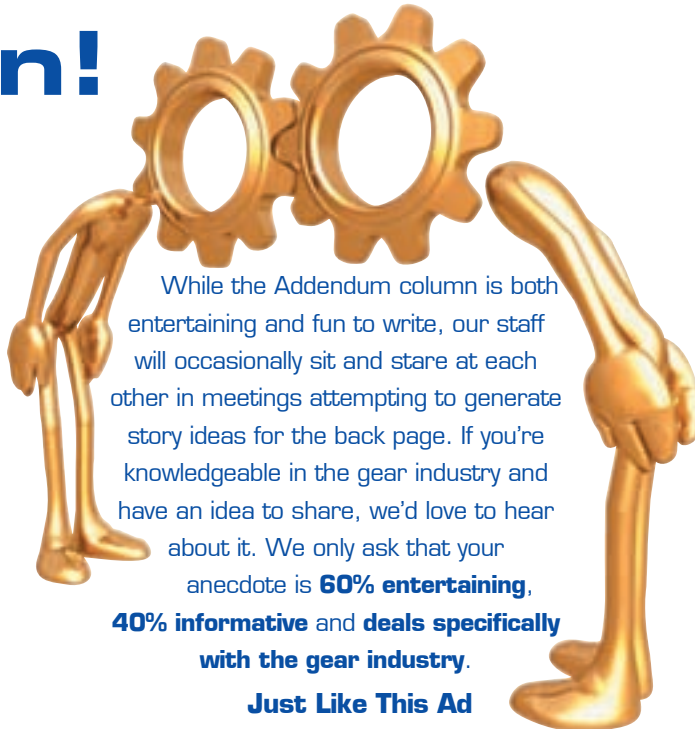

While the Addendum column is both entertaining and fun to write, our staff will occasionally sit and stare at each other in meetings attempting to generate story ideas for the back page. If you're knowledgeable in the gear industry and have an idea to share, we'd love to hear about it. We only ask that your anecdote is **60% entertaining, 40% informative** and **deals specifically with the gear industry.**

Just Like This Ad

Please help us start talking to each other again by submitting your ideas to: mjaster@geartechnology.com, jmcguinn@geartechnology.com or wrs@geartechnology.com.

Also, an important tooth geometry capability is provided by the software. An anti-twist feature automatically eliminates gear tooth twist to the desired degree. Simple input parameters command the software to achieve this special and exact geometry, which is required in wind turbine applications.

In addition, the software, combined with the control of several machine axes, allows simultaneous grinding of both tooth flanks even though each flank has a different lead and crown. It is difficult to visualize this seemingly impossible capability. As a result, double-flank grinding is being achieved in production and is resulting in reduced cycle times of up to 50%, especially as compared with single-flank grinding.

- **Large-gear measurement.** With introduction of the Sigma 3000GMM, Gleason has extended its Sigma series of analytical gear inspection systems to meet the needs of the largest gears for wind power applications, and to 'close the loop' on quality. Gears up to 3 meters in diameter and weighing up to 9,100kg (20,000 lbs.) can be measured on the Sigma 3000GMM. The Sigma features a new Renishaw SP80H full 3-D scanning probe head, and GAMA Windows-based software to speed and simplify the process. In addition, the Sigma 3000GMM uses a small-grain, high-density granite base for added rigidity and stability.

Offering a Prototype and Pre-Production Jobbing Capability

Underway at Gleason's Rochester, NY facility is the development of a gear manufacturing capability, designed to assist customers with prototyping and pre-production manufacturing. This capability is designed to help test, perfect and produce gears in short runs for the many new wind turbine programs underway in the U.S. and Canada.

For more information:

Gleason Corp.
1000 University Avenue
Rochester, NY 14692
Phone: (585) 473-1000
Fax: (585) 461-4348
Internet: www.gleason.com

TO COMPETE GLOBALLY YOU NEED THE RIGHT TEAM

You already compete globally; Why not look to a global supplier for gear hobs. One that enables "your team" to take advantage of "our" competitive edge. **Dragon Precision Tools is a world-class leader** in maximizing gear hob tool life through innovative designs, with the latest in coatings and high speed steels. **The global gear market relies on Dragon to perform in any playing conditions.** Look to us to get you through any challenge the marketplace has to offer.



Dragon Precision Tools

PHONE: +82.32.814.1540
FAX: +82.32.814.5381

WWW.DRAGON.CO.KR

Gear Workholding.

**If it's hard to hold...
the answer's not
hard to find.**

www.itwworkholding.com

When it comes to workholding solutions for gear machining, N.A. Woodworth provides a wealth of technical knowledge, expertise and engineering assistance that sets us apart. Our various designs include our Universal Gear (UG) and our newly developed Pitch Line (PLD) diaphragm chucks. We have the product to fit your process. All built with exacting standards to provide the best workholding solutions for gear machining. Give us a call.

N.A. Woodworth

Workholding Worldwide
1391 Wheaton • Suite 700 • Troy, Michigan 48083
800-544-3823 • Fax: 248-743-4401

ITW Workholding an ISO9001:2000 Registered Company







Perfect Teeth. No brushing required.

genesis

technology

Gleason



Shaving Machine



Hobbing Machine



Grinding Machine

Introducing the 210H Hobber: One more reason to buy Genesis®

Nothing succeeds like success. Now all the speed, productivity and performance found in the popular Genesis® 130H Hobber are available in the new, larger 210H, for cylindrical gears and shafts with outside diameters up to 210 mm. Designed for completely dry (or wet) cutting conditions... capable of loading/unloading parts in as little



Register at www.gleason.com to receive the new Gleason eNews.

as 3 seconds...and built exceptionally compact with all systems fully self-contained, the 210H is simply the most productive, best performing machine in its class. The Genesis family of Hobbers, Shavers and Threaded Wheel Grinders: The next generation of gear production technology.



Faster, more economical gear production starts – and finishes – with Genesis®
Download our new Genesis DVD at www.gleason.com/genesis.

Gleason

585-473-1000 www.gleason.com sales@gleason.com

KEEPING THE WORLD IN MOTION™

The New Power Generation

With All Eyes on Washington, U.S. Wind Industry Seeks Expansion

Matthew Jaster, Associate Editor

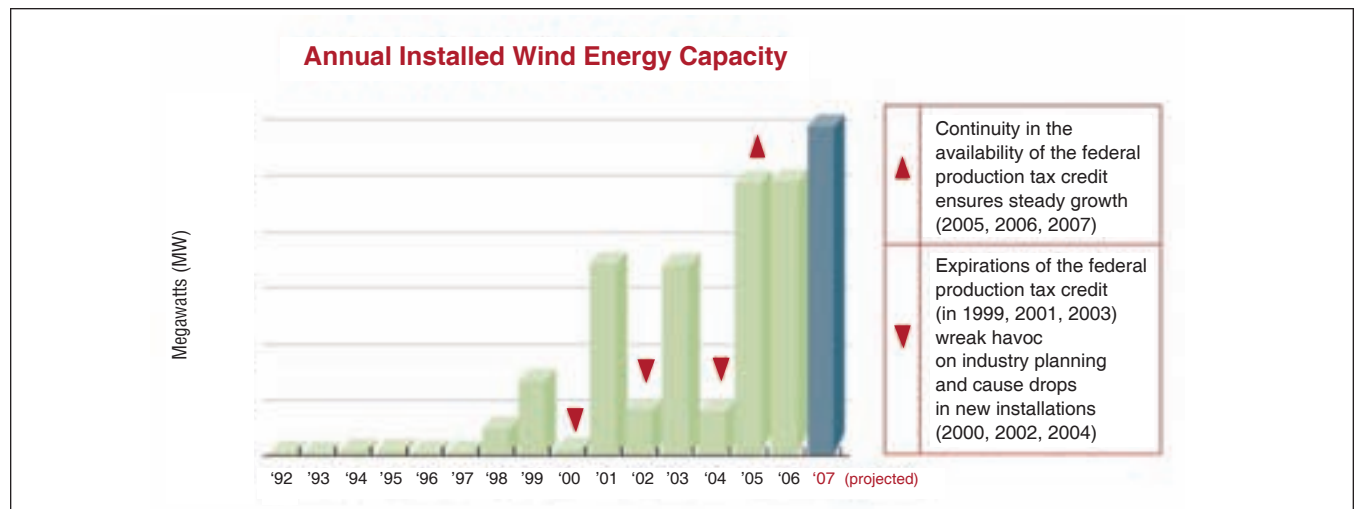

Information provided courtesy of the American Wind Energy Association.

Long before oil, climate change and energy demand were making headlines in Washington, Minnesota State Auditor Rebecca Otto and her husband installed a wind energy system on their property in Minnesota.

“A decade ago, renewable energy was really considered a ‘tree hugger’ issue,” says Otto. “It was quite unusual at the time. We installed our residential wind generator because we’re concerned about the future.”

In 2008, it’s safe to say Otto’s not alone in her concern. Although wind power currently generates a tiny fraction of U.S. electricity (about enough to power one million average homes), the issue is front and center in Washington as the country looks to transform its energy practices, policies and infrastructure.

“If long-term policies are put in place, we could see 5,000 MW of new generating capacity installed annually by 2010,” says Christine Real de Azua, assistant director of communications for

the American Wind Energy Association (AWEA). “If we continue with business as usual, however, with cyclical expiration and extension cycles of federal incentives, such growth is far from certain.”

According to the AWEA, U.S. wind power installations were on track to complete a total of 4,000 megawatts of power by the end of 2007, a thirty-three percent increase over previous expectations.

“In sheer number of megawatts, the U.S. has been the largest wind energy market in the world over the past two years,” says Real de Azua.

Currently, the AWEA is concentrating its efforts on a long-term-extension of the federal production tax credit (PTC), a federal renewable energy standard (RES) and investments in “renewable energy superhighways.”

The organization faces major challenges in its attempt to promote the energy benefits of wind power. These challenges include:

- Establishing a stable and supportive policy to promote growth and attract large-scale investments.
- Building transmission capacity to tap the nation’s wind resources.
- Addressing supply chain constraints.
- Addressing siting and permitting issues so they are reasonable and cost-effective for developers, satisfactory for communities and protective for the environment.
- Competing on cost to continue to gain market share and deliver benefits to the consumer and the nation.

The House of Representatives had recently approved an energy bill requiring electric utilities to get 15 percent of their energy from renewable sources by 2020. Unfortunately, it was removed from the final bill due to opposition from the White House.

Real de Azua believes the federal government needs to learn from the renewable energy policies currently in place at the state level.

“More than 20 states have success-

fully implemented a renewable energy standard,” says Real de Azua. “Perhaps most spectacularly in Texas, where the RES jump-started wind power development and the initial target was quickly exceeded.”

The oil-driven state of Texas, ironically, leads the country in wind installations with California, Iowa, Washington and Minnesota rounding out the top five.

In Minnesota, Otto says technology is one of the biggest factors in the development of wind energy. “Manufacturers are constantly coming out with new products, and tweaking the ones they have, which has helped overcome the old objections and reliability issues.”

Otto cites state laws and wind resource capacity as contributing factors in Minnesota’s renewable energy success. “Not only are cooperatives being formed by local farmers, but our legislature just passed one of the most aggressive renewable energy standards in the country.”

Skeptics question whether a federal renewable energy standard is needed since many states lack the necessary wind capacity. Mark Z. Jacobson, professor of civil and environmental engineering at Stanford University, says a federal standard could work.

“All states have some wind resources. Combining wind, solar, geothermal, tidal, wave and hydroelectric energy is ideal for smoothing out the electric supply.”

Real de Azua says installing “renewable energy superhighways” can also distribute the necessary wind supply via transmission lines from wind-rich areas to the market. “Several states and regions are doing this, and the federal government can apply those models at the national level.”

According to Jacobson, wind will play a large role in domestic energy in the future because of its low cost and abundance. “The world has over seven times more wind over land in fast wind locations than potential hydroelectric power available.”

If environmentalists and trade associations can’t get through to politicians, perhaps the next generation can.

“There has been a tremendous surge in interest in students and the general population in renewable energy,” says Jacobson. “Five of the top seven courses in our department (civil and environmental engineering) last year were

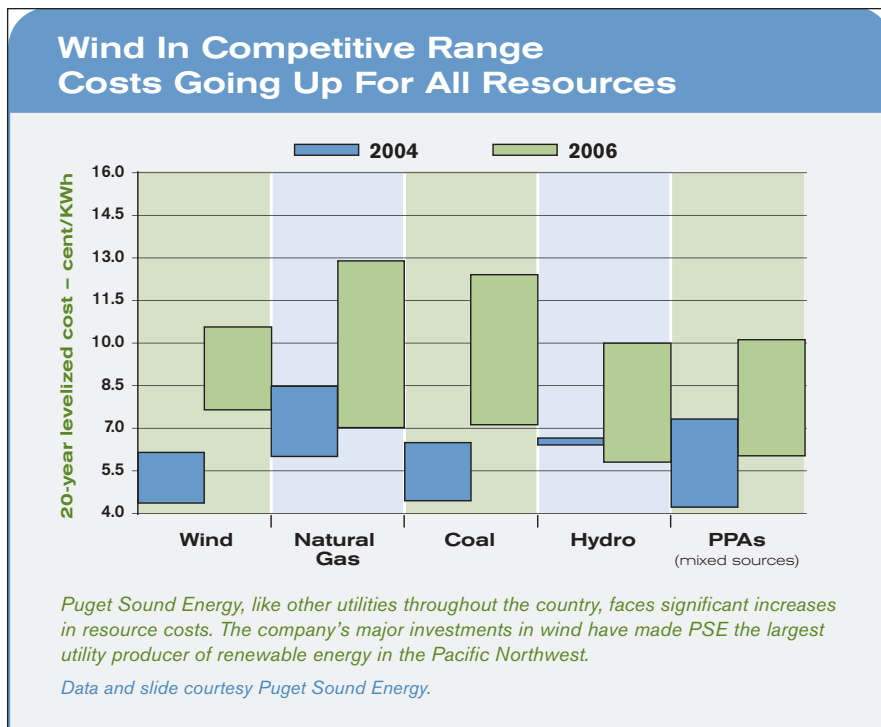

Information provide courtesy of the American Wind Energy Association.

energy-related. Applications to our atmosphere/energy program also doubled in the last two years. My children are learning about both atmosphere and energy in elementary and middle school. Times have changed rapidly.”

Progressive policies, public support and education seem to be working in Europe, where cost reductions and community wind projects have helped Germany, Spain and Denmark thrive in the wind market.

According to the European Wind Energy Association (EWEA), offshore wind projects are a priority as the industry attempts to provide large-scale renewable power to Europe. Meanwhile, a strategic energy technology plan proposed by the European Commission is currently being addressed to help allocate funds for research investments in renewable energy technologies.

Here in the United States, wind energy advocates continue to wait on Washington.

“With the right policies, the U.S. could secure its newly found but fragile leadership in wind power, and become a hub of wind power development and manufacturing,” says Real de Azua. “The right energy legislation can make a big difference for both young and established industries in the U.S.”

Despite all the question marks, Otto

remains optimistic that public demand for renewable energy will continue to grow.

“Everyone is motivated to make this a more prominent source of power,” says Otto. “Wind is only one piece of our diverse energy pie. We’ll continue to come with new technologies that will supplement older technologies, but we’ll always have to be diversified to meet our needs.”

For more information:

American Wind Energy Association
 1101 14th St. N.W. 12th Floor
 Washington, D.C. 20005
 Phone: (202) 383-2500
 Fax: (202) 383-2505
 E-mail: windmail@awea.org
 Internet: www.awea.org

Great Minds! Great Gears! Great Polymers!

Ask the Ticona Gearheads™



Great Minds!

Put our polymer and application brainpower to work for you.

Ticona is the world leader in plastic gear technology. For over 30 years, our gearheads – better known as gear technology experts – have helped to dramatically reduce the cost, weight and noise of gear drives for countless applications.

Great Gears!

- Reduce noise
- Boost efficiencies
- Lower cost
- Increase design flexibility
- Eliminate the need for lubricants
- Resist chemicals and corrosion

Great Polymers!

Celanex® thermoplastic polyester (PBT)

Celcon® and *Hostaform*® acetal copolymer (POM)

Celstran® and *Compel*® long fiber reinforced thermoplastics (LFRT)

Fortron® polyphenylene sulfide (PPS)

GUR® ultra-high molecular weight polyethylene (UHMW-PE)

Riteflex® thermoplastic polyester elastomer (TPC-ET)

Vectra® liquid crystal polymer (LCP)

Contact the Ticona Gearheads for the best polymer to fit your application at 1.800.833.4882.

Ticona
Engineering Polymers

Performance Driven Solutions™

8040 Dixie Highway, Florence, KY 41042

1.800.833.4882 www.ticona.com



Evaluation of a Low-Noise, Formate Spiral Bevel Gear Set

David G. Lewicki, Faydor L. Litvin, Ron L. Woods and Alfonso Fuentes

Management Summary

Studies to evaluate low-noise Formate spiral bevel gears were performed. Experimental tests were conducted on a helicopter transmission test stand. Low-noise, Formate spiral bevel gears were compared to the baseline OH-58D spiral bevel gear design; a high-strength design; and previously tested, low-noise designs (including an original low-noise design and an improved-bearing-contact, low-noise design). Noise, vibration and tooth strain tests were performed.

Introduction

Spiral bevel gears are used extensively in rotorcraft applications to transfer power and motion through non-parallel shafts. In helicopter applications, spiral bevel gears are used in main-rotor and tail-rotor gearboxes to drive the rotors. In tilt-rotor applications, they are used in interconnecting drive systems to provide a mechanical connection between two prop rotors should one engine become inoperable. Spiral bevel gears have had considerable success in these applications, yet they remain a main source of vibration and noise in gearboxes. Also, higher strength and lower weight are required to meet the needs of future aircraft.

Previous studies on gears with tooth fillet and root modifications to increase strength were reported, as well as gears with tooth surfaces designed for reduced transmission errors (Refs. 1–2). The teeth were designed using the methods of Litvin and Zhang (Ref. 3) to exhibit a parabolic function of transmission error at a controlled low level (8 to 10 arc sec). This eliminated discontinuities in transmission error, thus reducing the vibration and noise caused by the mesh. The new tooth geometries for this design were achieved through slight modification of the machine tool settings used in the manufacturing process of the pinion. The design analyses addressed tooth generation, tooth contact analysis, transmission error prediction and effects of misalignment (Refs 3–6). The results from these tests showed a significant decrease in spiral bevel gear noise, vibration and tooth fillet stress. However, a hard-line condition (concentrated wear lines) was present on the pinion tooth flank area. A hard-line condition could possibly lead to premature failure such as early pitting/surface fatigue, excessive wear, or scoring, and should be avoided in a proper gear design. Subsequent analyses and tests were performed to improve the gear tooth contact (eliminate the hard-line) while maintaining low noise, vibration and fillet stress (Refs. 7–8).

Spiral bevel gears in current helicopter applications (as well as the low-noise, high-strength designs described above) are manufactured using a face milling process (Ref. 9). The gear material is carburized, and the final manufacturing process—grinding—produces extremely high-precision tooth surfaces. In the face milling process, a circular cutter (or grinding wheel) is designed and set into position, relative to the gear blank, to cut the correct spiral and pressure angles at a specific point on the tooth. The cutter then sweeps out the tooth form as it rotates about its axis (Ref. 9). This relative motion between the cutter and the gear blank is a time-consuming and costly process, but is required to produce accurate teeth.

An alternative manufacturing approach is the Formate process (Ref. 10). Similar to the face milling process, the cutter/grinding wheel is positioned relative to the gear blank so that the correct spiral and pressure angles will be produced. The gear blank, however, is held stationary and a tooth slot is form-cut by in-feeding the cutter without relative motion between the cutter and gear blank. This subtle-yet-important difference substantially reduces the time and cost needed for manufacture. The resulting tooth surface from the Formate process is a straight-tooth, cross-sectional profile. Thus, the process is only applicable to the gear—and not the pinion—in order to achieve proper meshing and a good contact pattern. This still provides significant manufacturing cost reduction benefits, as the gear customarily has a greater number of teeth than the pinion.

Analyses were performed to apply the low-noise design methodology described above to the Formate manufacturing process (Refs. 11–12). Again, the analysis addressed tooth generation, tooth contact analysis, transmission error prediction and effects of misalignment. A Formate spiral bevel gear, along with a specially generated pinion matched for low noise, were fabricated and tested. The objective of this

report is to describe the results of the experiments in evaluating the low-noise, Formate spiral bevel gear set design. Experimental tests were performed on the OH-58D helicopter main-rotor transmission in the NASA Glenn 500-hp helicopter transmission test stand. The low-noise, Formate spiral bevel gear design was compared to: a baseline OH-58D spiral bevel gear design; a high-strength design; and previous low-noise designs. Noise, vibration and tooth strain test results are presented.

Apparatus

OH-58D main-rotor transmission. The OH-58 Kiowa is an Army single-engine, light observation helicopter—an advanced version developed under the Army Helicopter Improvement Program (AHIP). The OH-58D main-rotor transmission is shown in Figure 1. It is currently rated at maximum continuous power of 410 kW (550 hp) at 6,016 rpm input speed, with the capability of 10 sec torque transients to 475 kW (637 hp), occurring at a maximum of once per hour. The main-rotor transmission is a two-stage reduction gearbox with an overall reduction ratio of 15.23:1. The first stage is a spiral bevel gear set with a 19-tooth pinion that meshes with a 62-tooth gear. Triplex ball bearings and one roller bearing support the bevel pinion shaft. Duplex ball bearings and one roller bearing support the bevel gear shaft. Both pinion and gear are straddle-mounted.

A planetary mesh provides the second reduction stage. The bevel gear shaft is splined to a sun gear shaft. The 27-tooth sun gear meshes with four 35-tooth planet gears, each supported with cylindrical roller bearings. The planet gears mesh with a 99-tooth, fixed ring gear splined to the transmission housing. Power is taken out through the planet carrier splined to the output mast shaft. The output shaft is in turn supported on top by a split, inner-race ball bearing, and on the bottom by a roller bearing. The 62-tooth bevel gear also drives a 27-tooth accessory gear. The accessory gear runs an oil pump—which supplies lubrication through jets and passageways located in the transmission housing—as well as a hydraulic pump for aircraft controls.

Spiral bevel test gears. Five different spiral bevel pinion and gear designs were compared. The first design was the baseline and used the current geometry of the OH-58D design. Table 1 lists basic design parameters. The reduction ratio of the bevel set is 3.26:1. All gears were made using standard aerospace practices by which the surfaces were carburized and ground. The material used for all test gears was X-53 (AMS 6308). Two sets of the baseline design were tested (Ref. 1). The second spiral bevel design was an increased-strength design. The configuration was identical to the baseline except that the tooth fillet radius of the pinion was increased by a factor of approximately two. Also, the tooth fillet radius of the gear was slightly increased (approximately 1.16 times the baseline) and made full-fillet. Tooth fillet radii larger than those on conventional gears were made possible by advances in spiral bevel gear grinding technology. Advanced gear grinding was achieved through redesign of a

current gear grinder and the addition of computer numerical control (CNC) (Ref.13). Two sets of the increased-strength design were tested (Ref.1).

The third spiral bevel design was a low-noise design. The low-noise design was identical to the increased-strength design, except that the pinion teeth were slightly altered to reduce transmission error. The gear member was the same as in the increased-strength design. The low-noise design was based on the idea of local synthesis that provided the following conditions of meshing and contact at the mean contact point (Ref. 3): a) the required gear ratio and its derivative, b) the desired direction of the tangent to the contact path, and c) the desired orientation and size of the major axis of the instantaneous contact ellipse. The local synthesis was complemented by a tooth contact analysis (Ref. 3). Using this approach, the machine tool settings for reduced noise were determined. As with the high-strength design, precise control of the manufactured tooth surfaces was made possible by advances in the final grinding operation machine tool (Ref. 13). Further information on the low-noise design can be found in References 1–4. In summary, the effect of the topological change in the low-noise design was a reduction in the overall crowning of the tooth, leading to an increase in contact ratio and reduced transmission error.

Two sets of a first attempt at a low-noise design were tested (Ref. 1); this included two low-noise pinions and two gear members that were the same as the high-strength design.

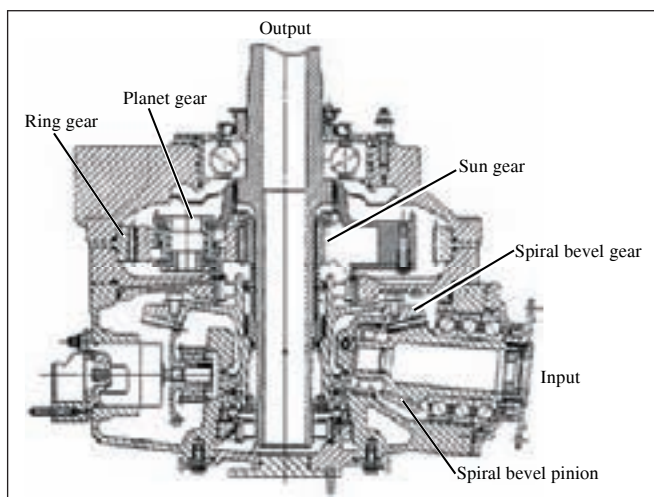

Figure 1—OH-58D helicopter main-rotor transmission.

Table 1. Baseline Spiral-bevel gear parameters of the OH-58D main-rotor transmission.	
pinion, number of teeth	19
gear, number of teeth	62
Module, mm (diametral pitch, in ⁻¹)	4.169 (6.092)
Pressure angle, deg	20
Mean spiral angle, deg	35
Shaft angle, deg	95
Face width, mm (in.)	36.83 (1.450)

In addition, one low-noise pinion with 0.050" TOPREM, one low-noise pinion with 0.090" TOPREM and one low-noise pinion with 0.120" TOPREM were tested (Ref. 8). TOPREM is the decrease in the pressure angle at the tip of the grinding wheel used on the pinion during final machining. This decrease in pressure angle causes more stock to be removed in the flank portion of the tooth to prevent interference with the top of the gear member during operation. The 0.050", 0.090" and 0.120" designations refer to the depth of modification along the blade cutting edge.

The fourth spiral bevel design was an improved-bearing-contact, low-noise design. This new design was in general based on the principles of the previous low-noise design, but also included an improved iterative approach balancing low-transmission errors for reduced noise with tooth contact analysis to avoid adverse contact and concentrated wear conditions (Ref. 7). In addition, modified roll was used in the pinion generation, and finite element analysis was used to evaluate stress and contact conditions. One low-noise, improved-bearing-contact pinion was tested (Ref. 8).

Lastly, the fifth design tested was a 62-tooth, spiral bevel gear manufactured using the Formate process. The 19-tooth, spiral-bevel pinion was manufactured using the conventional, face-milled grinding process. The gear set was designed to reduce transmission error, vibration, noise and stress, as well as to provide proper tooth contact (Refs. 11–12). One Formate set was tested, and the results are compared to the

previously published tests.

NASA Glenn 500-hp helicopter transmission test stand.

The OH-58D transmission was tested in the NASA Glenn 500-hp helicopter transmission test stand (Fig. 2). The test stand operates on the closed-loop—or torque-regenerative—principle. Mechanical power re-circulates through a closed loop of gears and shafting, part of which is the test transmission. The output of the test transmission attaches to the bevel gearbox. The output shaft of the bevel gearbox passes through a hollow shaft in the closing-end gearbox and connects to the differential gearbox. The output of the differential attaches to the hollow shaft in the closing-end gearbox. The output of the closing-end gearbox connects to the speed increaser gearbox. The output of the speed increaser gearbox attaches to the input of the test transmission, thereby closing the loop.

A 149-kW (200-hp), variable-speed, direct-current (DC) motor powers the test stand and controls the speed. The motor output attaches to the closing-end gearbox. The motor replenishes losses due to friction in the loop. An 11-kW (15-hp) DC motor provides the torque in the closed loop. This motor drives a magnetic particle clutch. The clutch output does not turn, but it exerts a torque. This torque is transferred through a speed reducer gearbox and a chain drive to a large sprocket on the differential gearbox. The torque on the sprocket applies torque in the closed loop by displacing the gear attached to the output shaft of the bevel gearbox with respect to the gear connected to the input shaft of the closing-end gearbox. This is done within the differential gearbox by use of a compound planetary system where the planet carrier attaches to the sprocket housing. The magnitude of torque in the loop is adjusted by changing the electric field strength of the magnetic particle clutch.

A mast shaft loading system in the test stand simulates rotor loads imposed on the OH-58D transmission output mast shaft. The OH-58D transmission output mast shaft connects to a loading yoke. Two vertical-load cylinders connected to the yoke produce lift loads. A 14,000-kPa (2,000-psig) nitrogen gas system powers the cylinders. Pressure regulators connected to the nitrogen supply of each of the load cylinders adjust the magnitude of lift. Note that in the OH-58D design, the transmission at no-load is misaligned with respect to the input shaft. At 18,309 N (4,116 lb) mast lift load, the elastomeric corner mounts of the OH-58D transmission housing deflect such that the transmission is properly aligned with the input shaft. (In the actual helicopter, this design serves to isolate the airframe from the rotor vibration).

The test transmission input and output shafts have speed sensors, torque meters, and slip rings. Both load cylinders on the mast yoke are mounted to load cells. The 149-kW (200-hp) motor has a speed sensor and a torque meter. The magnetic particle clutch has speed sensors on the input and output shafts and thermocouples. An external oil-water heat exchanger cools the test transmission oil. A facility oil-pumping and cooling system lubricates the differential,

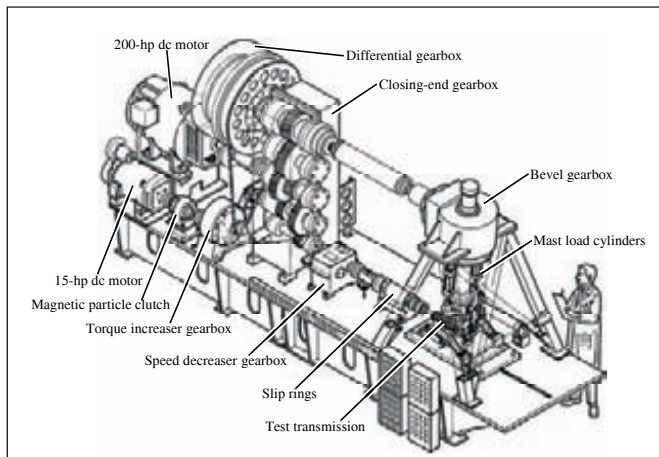

Figure 2—NASA Glenn 500-hp helicopter transmission test facility.

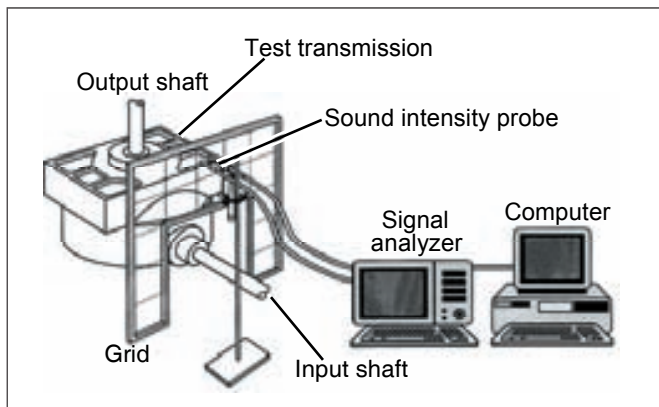

Figure 3—Sound intensity measurement system.

closing-end, speed increaser and bevel gearboxes. The facility gearboxes have accelerometers, thermocouples and chip detectors for health and condition monitoring.

Test Procedure

From the previous studies (Refs.1–2), two sets of the baseline design (each set consisting of a pinion and gear), two sets of the high-strength design and two sets of the original low-noise design were manufactured and tested. Note that the gear members for the high-strength set and original low-noise set were the same gear geometry (same manufacturing settings). There were four of these gear members manufactured—two for the high-strength set and two for the low-noise set. Again, these gears differed from the gear member of the baseline set due to the increased fillet radius and full fillet. Also from previous studies (Ref. 8), three additional, low-noise design pinions with various TOPREM modifications were manufactured and tested. These pinions meshed with one of the gear members of the original low-noise set for all of their tests. Also, one improved-bearing-contact, low-noise design pinion was manufactured and tested (Ref. 8). This pinion meshed with one of the gear members of the high-strength set for all of its tests.

As a summary, noise and vibration tests were performed on all pinions and gears manufactured. In addition, one set of each design was instrumented with strain gages, and strain tests were performed on these. (Again, the improved-bearing-contact, low-noise design pinion meshed with the instrumented gear member of the high-strength set for its strain tests.) A description of the instrumentation, test procedure and data reduction procedure follows.

Noise tests. Acoustic intensity measurements were performed using the two-microphone technique. The microphones used had a flat response (± 2 dB) up to 5,000 Hz and a nominal sensitivity of 50 mV/Pa. The microphones were connected to a spectrum analyzer, which computed the acoustic intensity from the imaginary part of the cross-power spectrum. Near the input region of the OH-58D transmission, a grid was installed which divided the region into 16 areas (Fig. 3). For each test, the acoustic intensity was measured at the center of each of the 16 areas. Only positive acoustic intensities (noise flowing out of the areas) were considered. The acoustic intensities were then added together and multiplied by the total area of the grids to obtain sound power of the transmission input region.

At the start of each test, the test transmission oil was heated using an external heater and pumping system. For all the tests, the oil used conformed to a DOD-L-85734 specification. Once the oil was heated, the transmission input speed was increased to 3,000 rpm, a nominal amount of torque was applied, and mast lift load was applied to align the input shaft (18,310 N, 4,120 lb). The transmission input speed and torque were then increased to the desired conditions. The tests were performed at 100 percent transmission input speed (6,016 rpm), and torques of 50, 75, 100 and 125 percent of maximum design. The transmission oil inlet temperature was

set at 99° C (210° F). After the transmission oil outlet stabilized (which usually required about 20 min), the acoustic intensity measurements were taken. The time to obtain the acoustic intensity measurements of the 16 grid points at a given test condition was about 30 minutes. For each acoustic intensity spectrum at a grid point, 100 frequency-domain averages were taken. This data was collected by a computer. The computer also computed the sound power spectrum of the grids after all the measurements were taken.

Vibration tests. Eight piezoelectric accelerometers were mounted at various locations on the OH-58D transmission housing (Fig. 4). The accelerometers were located near the input spiral bevel area (accelerometers 1 and 2, measuring radially to the input shaft), the ring gear area (accelerometers 3 and 4, measuring radially to the planetary) and on the top cover (accelerometers 5 to 8, measuring vertically). All accelerometers had a 1- to 25,000-Hz (± 3 dB) response, 4 mV/g sensitivity and integral electronics. Figure 5 shows a photograph of the noise and vibration test setup.

The vibration tests were performed in conjunction with the noise tests. For the previous studies (Refs. 1, 2 and 8), the vibration data were recorded on tape and processed off-line after collecting the acoustic intensity data for a given test. The vibration data were later analyzed using time averaging. Here, the vibration data recorded on tape were input to a signal analyzer along with a tach pulse from the transmission

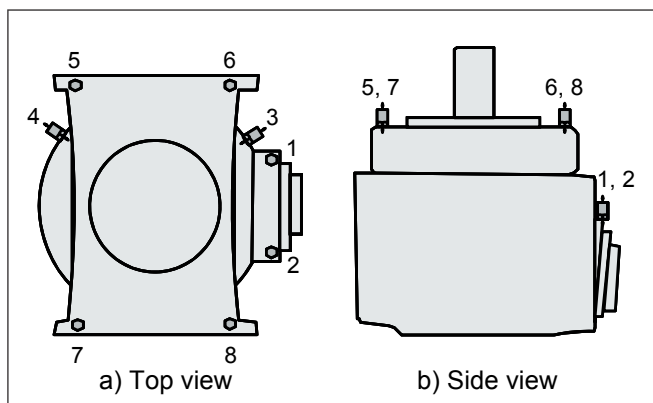

Figure 4—Accelerometer locations on OH-58D transmission.



Figure 5—Noise/vibration test setup.

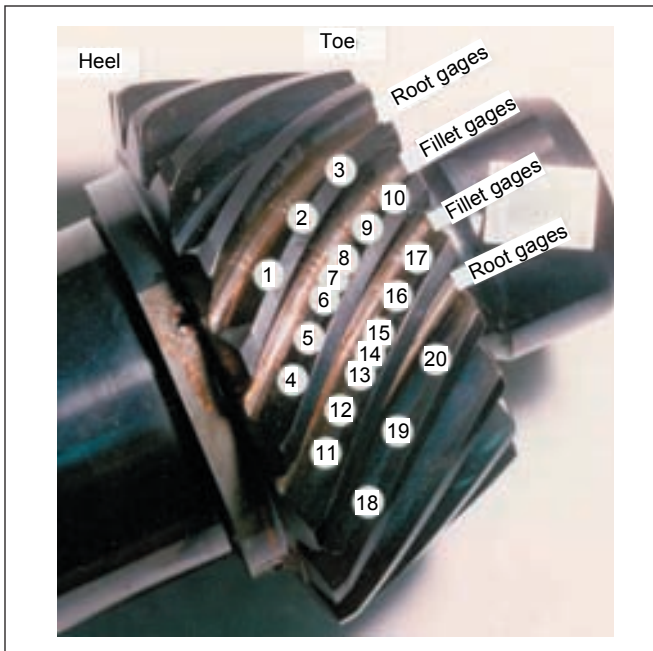

Figure 6—Strain gage locations on spiral bevel pinion.

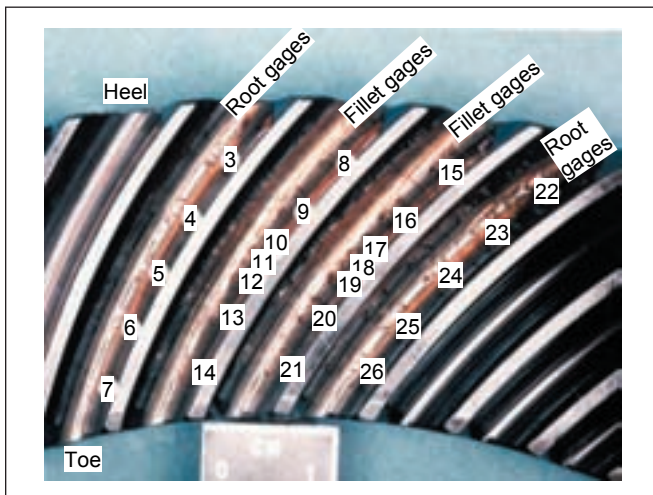

Figure 7—Strain gage locations on spiral bevel gear.



Figure 8—Static strain test setup.

input shaft. The signal analyzer was triggered from the tach pulse to read the vibration data when the transmission input shaft was at the same position. The vibration signal was then averaged in the time domain using 100 averages. This technique removed all the vibration which was not synchronous to the input shaft. Before averaging, the major tones in the vibration spectrum of the OH-58D baseline design were the spiral bevel and planetary gear fundamental frequencies and harmonics. Time averaging removed the planetary contribution, leaving the spiral bevel contribution for comparing the different design configurations.

For the current Formate tests, this above procedure was performed in real time using a computer, and the tape recording was not used. Due to limitations of the number of input channels available for the computer, only seven of the eight accelerometers were processed for the Formate tests. Accelerometers 1-6 and 8 were processed; accelerometer 7 was not.

Strain tests. Twenty strain gages were mounted on the spiral bevel pinions for one set of each of the five designs (Fig. 6). Twenty-six gages were mounted on the spiral bevel gears (Fig. 7). Gages were positioned across the tooth face widths with some in the fillet area and some in the root area of the teeth. The fillet gages were placed on the drive side of two adjacent teeth. The fillet gages were also positioned at a point on the tooth cross-section where a line at a 45° angle with respect to the tooth centerline intersects the tooth profile. The fillet gages were placed there to measure maximum tooth-bending stress. (Previous studies on spur gears showed that the maximum stresses were at a line 30° to the tooth centerline (Ref. 14). Forty-five degrees was chosen for the current tests to minimize the possibility of the gages being destroyed due to tooth contact. In addition to maximum tensile stresses, root stresses can become significant in lightweight, thin-rimmed aerospace gear applications (Ref. 15). Thus, root gages were centered between teeth in the root to measure gear rim stress. Tooth fillet and root gages were placed on successive teeth to determine loading consistency. The grid length of the gages was 0.381 mm (0.015 in.) and the nominal resistance was 120 Ω. The gages were connected to conditioners using a Wheatstone bridge circuitry and quarter-bridge or half-bridge arrangements. (Half-bridge arrangements were used with an adjustable resistor for cases where a gage would not balance in the quarter-bridge arrangement.)

Static strain tests were performed on both the spiral bevel pinions and gears. A crank was installed on the transmission input shaft to manually rotate the shaft to the desired position. A sensor was installed on the transmission input shaft to measure shaft position. At the start of a test, the transmission was completely unloaded and the strain gage conditioners were zeroed. Conditioner spans were then determined using shunt calibrations. The transmission was loaded (using the facility closed-loop system) to the desired torque, the shaft was positioned, and the strain readings along with shaft positions were obtained using a computer. This was done for

a variety of positions to get strain as a function of shaft position for the different gages. At the end of a test, the transmission was again completely unloaded and the conditioner zeroes were checked for drift. A photograph of the static strain setup is shown in Figure 8.

Dynamic strain tests were performed only on the spiral bevel pinions. The pinion gages were connected to slip rings mounted on the input shaft. (A slip ring assembly for the spiral bevel gear was unavailable, and thus, dynamic strain tests of the gear were not performed.) The test procedure was basically the same as the noise and vibration tests, except that the transmission was not run as long in order to maximize strain gage life. A photograph of the dynamic strain setup is shown in Figure 9. The dynamic strain data were digitized into a computer and time-averaged in a manner similar to the vibration data. This procedure was used to remove random slip ring noise.

Results and Discussion

Noise tests. In inspecting the frequency content of the noise data, the sound power at the meshing frequency was a dominant noise source. Figure 10 depicts sound power as a function of torque. The sound power is the sum of the sound power at the spiral-bevel meshing frequency (1,905 Hz) and its first harmonic (3,810 Hz). As interpreted from the figure, the data is divided into three groups.

The first group is the circles and squares, which are the baseline and increased strength designs. The sound power (i.e., noise from the bevel gear mesh) for these designs shows a slight increase with torque. They give about the same trend with approximately 5 dB of scatter. This is expected since the bevel pinion and gear tooth geometries for this group were identical except for the fillet region.

The second group is the upward-facing triangles, which are the original low-noise designs, with and without TOPREM. These data show a significant decrease in noise, especially at the 100% torque condition (about 16 dB). They also show about the same trend with approximately 2 to 8 dB of scatter.

The third group is the solid diamonds and the downward-facing triangles, which are the data from the improved-bearing-contact, low-noise design and Formate design. The sound power from these designs is nearly constant with torque. The improved-bearing-contact, low-noise design shows a decrease in noise from the baseline design (about 7dB at 100% torque), but not as much reduction as the previous low-noise designs. The formate design also shows a slight decrease in noise from the baseline design (about 5dB at 100% torque).

Vibration tests. Figure 11 depicts the results from the vibration tests. Shown is acceleration as a function of torque for seven accelerometers mounted on the OH-58 transmission housing. Again, the acceleration was time-averaged with respect to the input shaft to remove all non-synchronous vibration. Upon inspection of the frequency content of the data, the majority of the time-averaged vibration stemmed



Figure 9—Dynamic strain test setup.

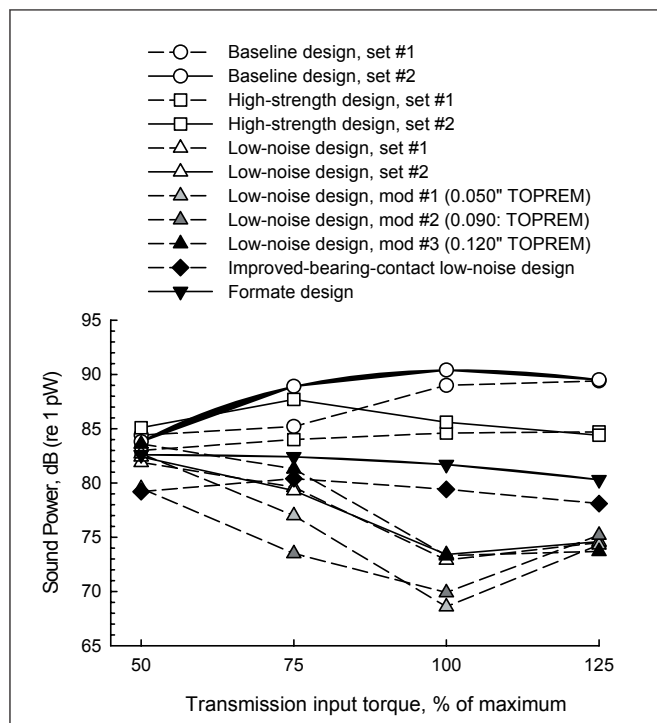

Figure 10—Sound power at spiral-bevel mesh frequencies.

from the spiral bevel mesh. The data points in the figure are the root-mean-square (rms) values of the time-averaged vibration time traces. In general, each figure can be divided into two groups: 1) baseline and high-strength designs (circles and squares); and 2) low-noise and Formate designs (triangles and diamonds). As with the noise results, there was a significant reduction in vibration for the low-noise designs compared to the baseline. For accelerometers 1, 4, 5, 6 and 8, the vibration for all the low-noise and Formate designs is basically lumped together with a scatter of about 3–5 g's. In general, the Formate design gave the same benefit in reduced vibration as that of the previously tested low-noise designs. As with the noise test results, the vibration for the Formate design was fairly constant with torque.

Strain tests. Results of the static strain tests at 100% torque for the strain gages are shown in Figures 12–15.

Shown is stress versus pinion shaft position for all gages of the baseline, high-strength, low-noise and Formate designs. Since the strain in the tooth fillet is mostly uniaxial and in the tangential direction of the tooth face (Ref. 16), the stress was calculated by multiplying the measured strain by the modulus of elasticity (30 x 106 psi for steel). For the pinion fillet gages (Fig. 12), the figure depicts results from gages on adjacent gear teeth (gages 4 and 11, 5 and 12, and 6 and 13) for the seven positions along the gear tooth face width. Gages 4 and 11 correspond to positions at the heel of the

pinion, and gages 10 and 17 correspond to positions at the toe of the pinion. The gages show typical results of a driving pinion member rolling through mesh. As it does so, it first sees a small amount of compression in the fillet when the tooth ahead of the strain-gaged tooth is in contact with the driven gear. As the pinion rolls further through mesh, the strain-gaged tooth is in contact with the driver and the fillet region sees tensile stress. At the maximum stress, the strain-gaged tooth is loaded in single-tooth contact. (Note that cases where data are missing from the figure—baseline

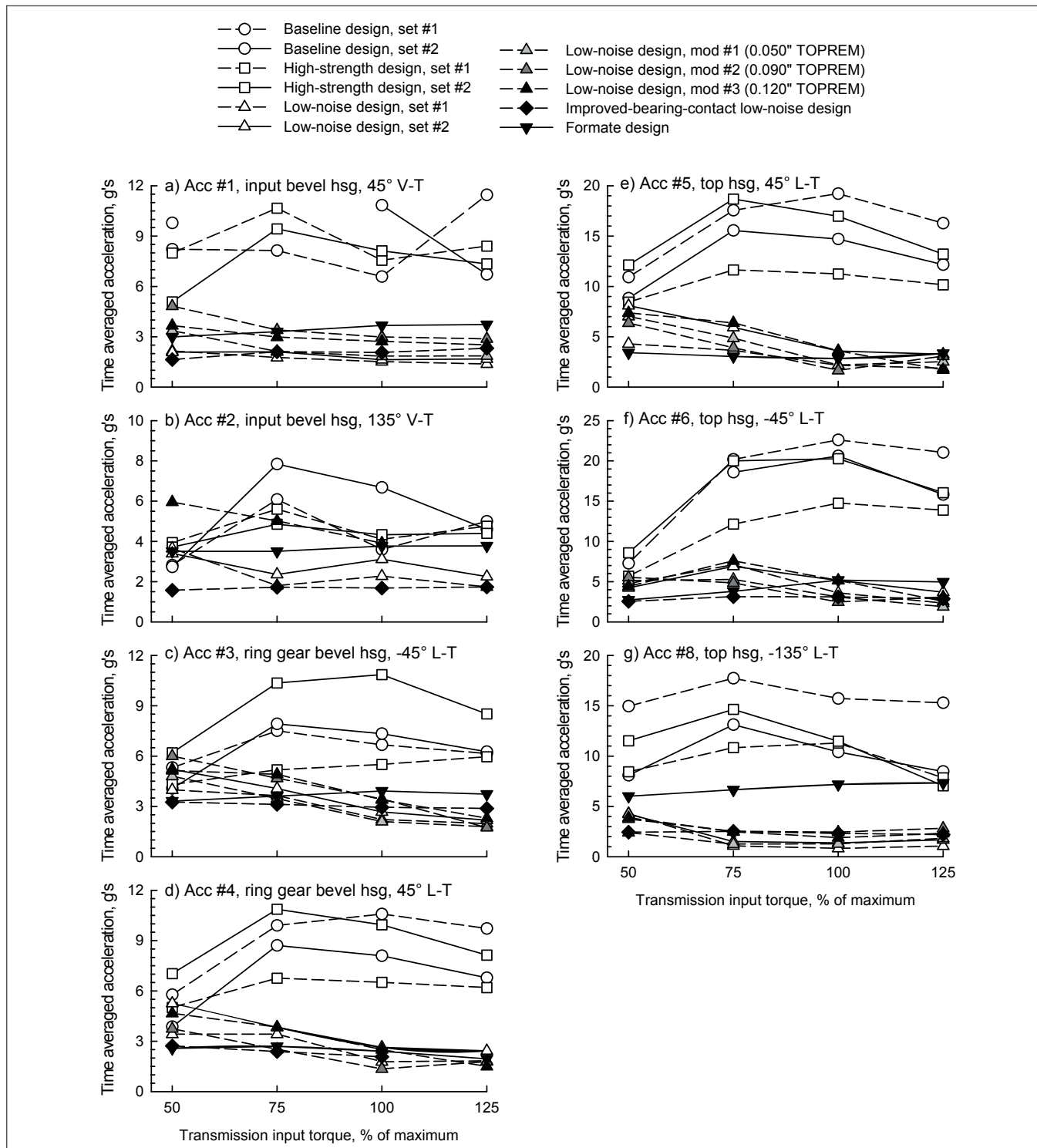

Figure 11—Vibration results.

design gages 4, 5, 8, 9 and 10, as examples—were due to faulty gages.

Figure 16 shows the maximum and minimum stresses as a function of position along the gear tooth face width. For the pinion fillet gages at 100% torque (Figs. 12 and 16a), the maximum tensile stress occurred at the middle of the tooth face width for the baseline and high-strength designs—gage 6, 7, 13 and 14 regions. It should be noted here that gages 6–8 and 13–15 were located as close to each other, respectively, as possible). The minimum stress (maximum com-

pression) for these designs occurred slightly to the heel side of the middle of the tooth face width. The maximum alternating stress occurred at the same location of the maximum tensile stress, where the alternating stress is defined as the maximum stress minus the minimum stress for a given gage position. For the Formate design, maximum values of the stresses (tensile, compressive, alternating) shifted significantly toward the heel, compared to the baseline design. This was also the case for the improved-bearing-contact, low-noise design. For the original low-noise design, maxi-

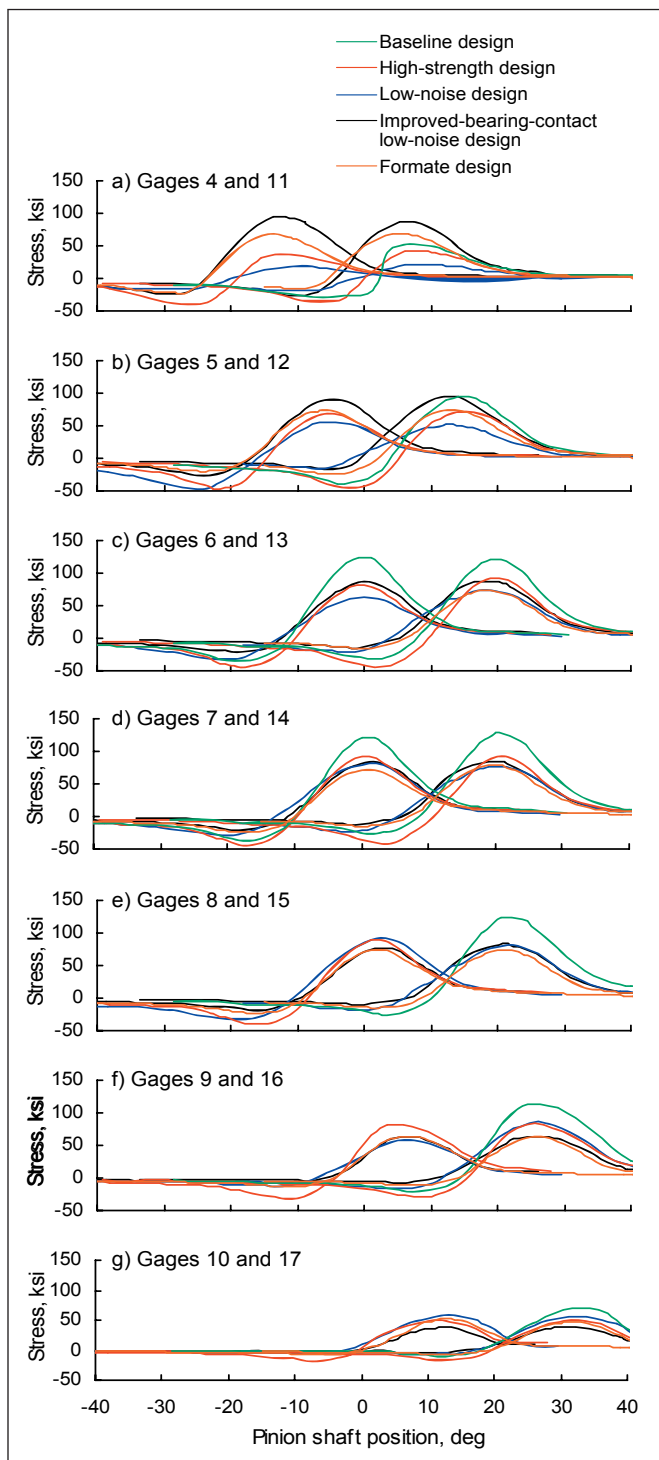

Figure 12—Results from static strain tests, pinion fillet gages, 100% torque (refer to Fig. 8 for strain gage locations).

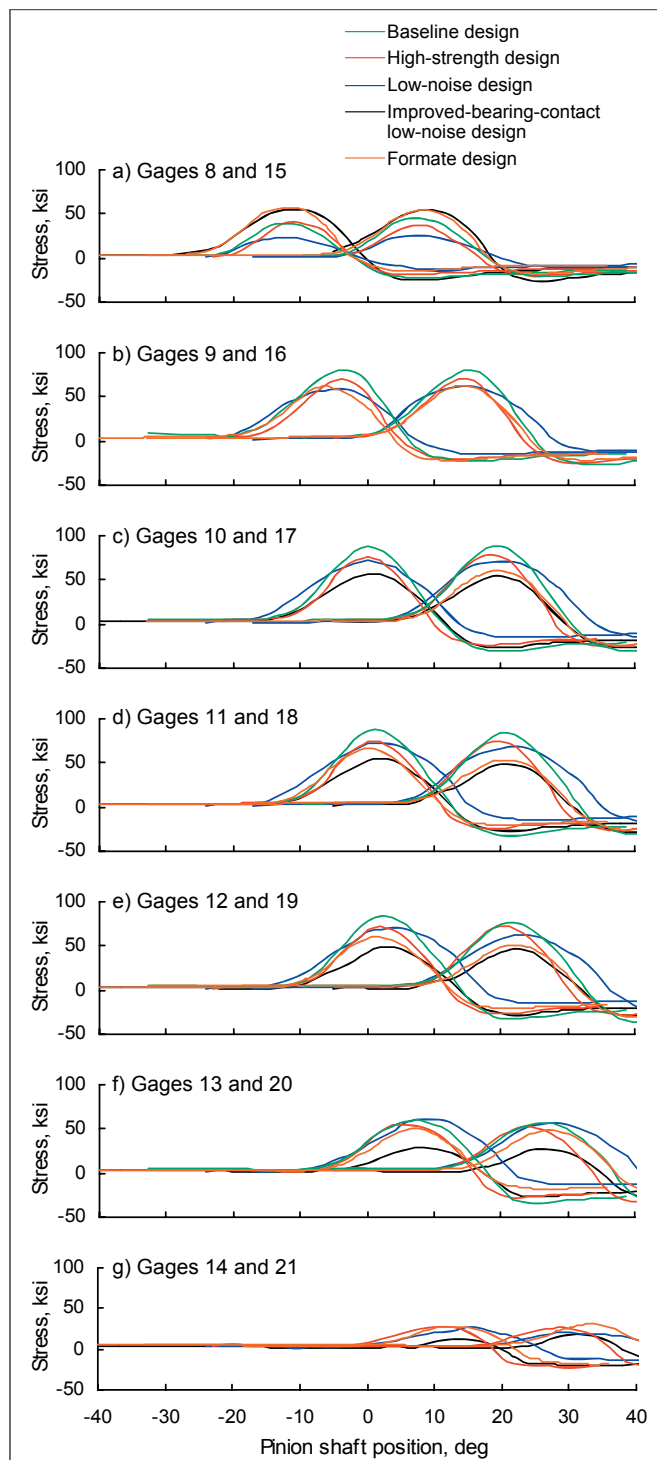

Figure 13—Results from static strain tests, gear fillet gages, 100% torque (refer to Fig. 7 for strain gage locations).

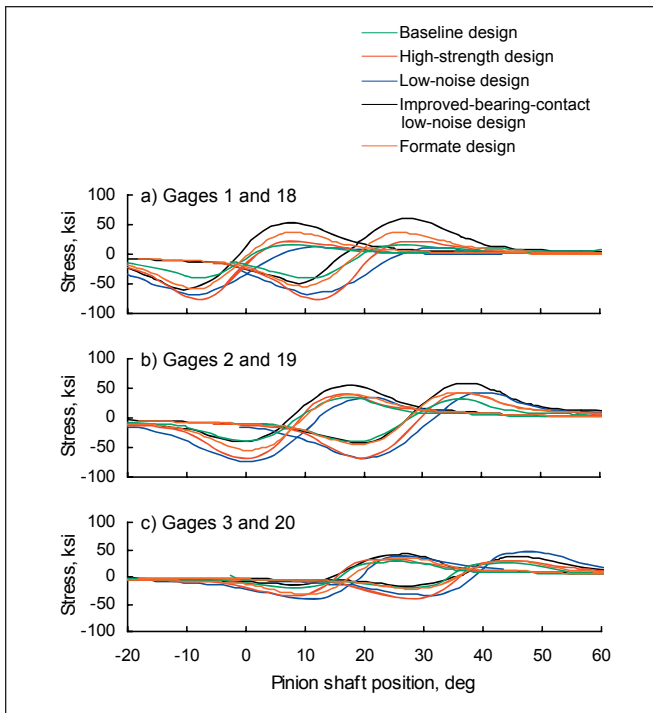

Figure 14—Results from static strain tests, pinion root gages, 100% torque (refer to Fig. 8 for strain gage locations).

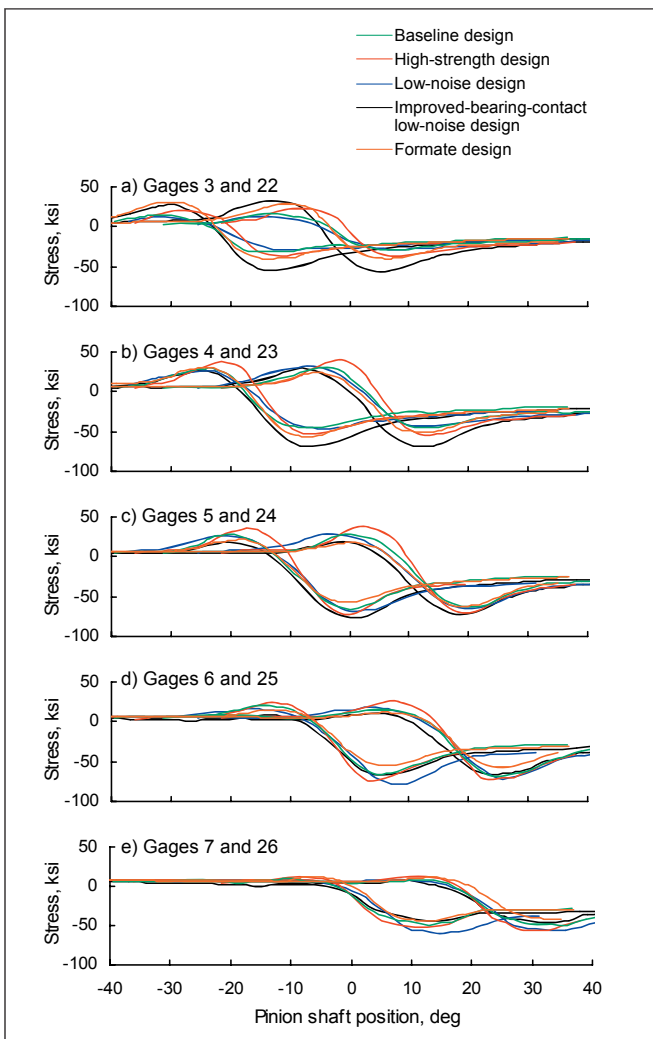

Figure 15—Results from static strain tests, gear root gages, 100% torque (refer to Fig. 8 for strain gage locations).

imum values of the stresses (tensile, compressive, alternating) shifted only slightly toward the toe, compared to the baseline design. Table 2 lists the values of the maximum, minimum and alternating stresses of the various designs tested at 100% torque. It should be noted that the values listed in the table were the average of the two rows of the corresponding gages. In all cases, the change column compares the stress to the baseline design. From Table 2a, there was a significant reduction in pinion fillet maximum tensile stress of the Formate, high-strength and original low-noise designs, compared to the baseline. There was less of a reduction for the improved-bearing-contact, low-noise design, but it was still significant.

For the gear fillet gages (Fig. 13), the shapes of the stress-position traces look similar to that of the pinion, except that the fillet compression occurs after the tension. This is because the tooth ahead of the strain-gage tooth sees contact with the driver member after the strain-gaged tooth is in contact. For the baseline design, high-strength design and original low-noise design, the maximum tensile stresses occurred at the middle of the tooth face width (Figs. 13 and 16b). For the Formate and improved-bearing-contact, low-noise designs, the maximum tensile stress shifted toward the heel. From Table 2b, there was a significant reduction in gear fillet maximum tensile stress for the Formate, high-strength, and all low-noise designs, compared to the baseline. The greatest benefit was from the improved-bearing-contact, low-noise design. Also, note that the magnitude of gear fillet tensile stresses was significantly lower than that of the pinion.

For the pinion root gages (Fig. 14), the stress-position traces were different than the fillet gages in that the maximum compression was nearly twice as great as the maximum tension. However, the magnitude of the maximum tension was significantly less than that in the fillet. Note that although the root gages were physically located three teeth apart (Fig. 6), they are plotted in Figure 14 as if they were on adjacent teeth. As with the fillet gages, the maximum stresses (tensile and alternating) occurred at the middle of the tooth face width for the baseline design, high-strength design and original low-noise design, and shifted toward the heel for the Formate and improved-bearing-contact, low-noise designs (Figs. 14 and 16c). The same trend was observed for the gear root gages (Figs. 15 and 16d). The maximum tensile stress in the pinion root significantly increased for the Formate, high-strength and original low-noise designs, compared to the baseline (Table 2c). The maximum tensile stress in the pinion root drastically increased for the improved-bearing-contact, low-noise design, compared to the baseline. The alternating stresses in the pinion root of the high-strength, and all low-noise designs increased about the same amount, compared to the baseline, whereas the increase was less for the Formate design. The maximum tensile stress in the gear root significantly increased for the high-strength design—compared to the baseline—but stayed the same for

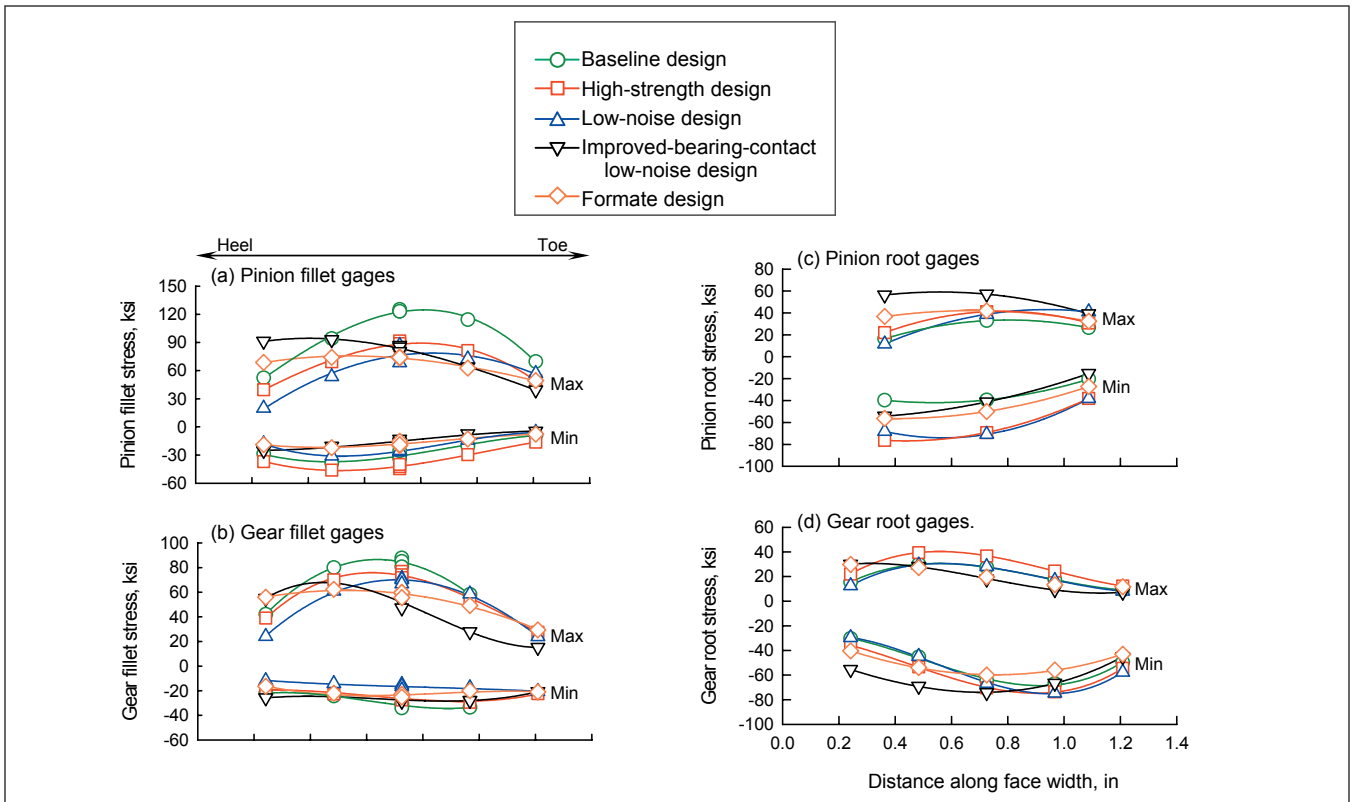

Figure 16—Maximum and minimum gear tooth stress distribution along tooth face width, static strain tests.

Table 2. Comparison of Formate design to previously tested designs, static strain test results at 100% torque.

a) Pinion fillet gages	Max Stress	Change	Min Stress	Change	Alt Stress	Change
	(ksi)	(%)	(ksi)	(%)	(ksi)	(%)
Baseline design	126.5		-37		157.1	
High-strength design	92.1	-27.2%	-45.9	22.3%	136.3	-13.3%
Low-noise design	89.2	-29.4%	-35.3	-6.1%	113.8	-27.6%
Improved-bearing-contact low-noise design	95.6	-24.4%	-26.2	-30.6%	116.4	-25.9%
Formate design	76.2	-39.7%	-24.5	-34.6%	98.1	-37.6%
b) Gear fillet gages	Max Stress	Change	Min Stress	Change	Alt Stress	Change
	(ksi)	(%)	(ksi)	(%)	(ksi)	(%)
Baseline design	87.8		-34.6		118.4	
High-strength design	76.9	-12.4%	-21.3	-38.4%	87.2	-14.4%
Low-noise design	71.1	-19.0%	-35.3	-6.1%	113.8	-26.6%
Improved-bearing-contact low-noise design	56.2	-35.0%	-28.9	-16.5%	82.4	-30.4%
Formate design	64.2	-26.9%	-26.1	-24.7%	85.3	-27.9%
c) Pinion root gages	Max Stress	Change	Min Stress	Change	Alt Stress	Change
	(ksi)	(%)	(ksi)	(%)	(ksi)	(%)
Baseline design	33.0		-39.9		72.5	
High-strength design	41.1	24.7%	-76.4	-91.2%	110.3	52.3%
Low-noise design	41.0	24.2%	-70.9	77.5%	109.7	51.3%
Improved-bearing-contact low-noise design	57.5	74.2%	-54.3	35.9%	110.6	52.7%
Formate design	42.0	27.2%	-56.3	40.9%	93.0	28.3%
d) Gear root gages	Max Stress	Change	Min Stress	Change	Alt Stress	Change
	(ksi)	(%)	(ksi)	(%)	(ksi)	(%)
Baseline design	30.0		-67.3		92.0	
High-strength design	39.5	31.5%	-73.6	9.4%	107.2	16.5%
Low-noise design	29.6	-1.5%	-74.6	10.9%	94.9	3.3%
Improved-bearing-contact low-noise design	30.0	0.0%	-74.2	10.3%	97.3	5.7%
Formate design	42.0	0.6%	-56.3	-10.7%	83.7	-9.0%

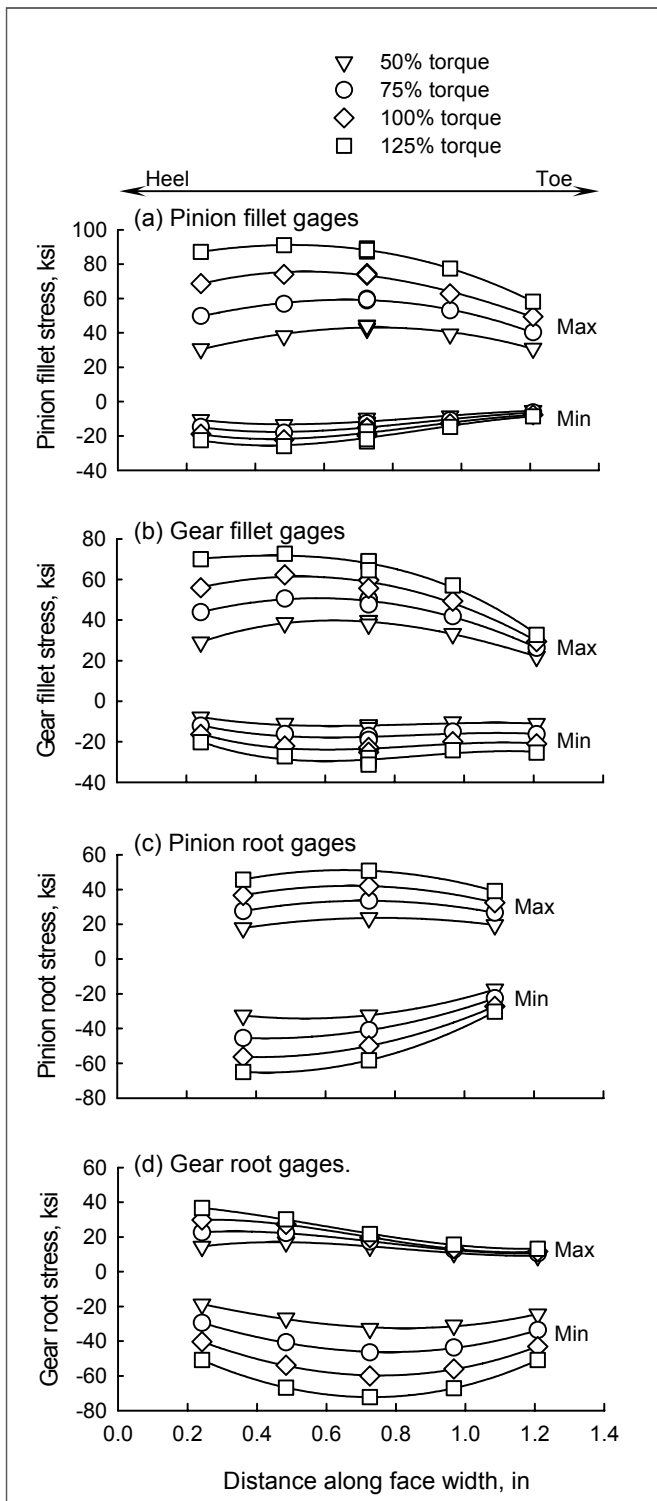

Figure 17—Effect of torque on the stress distribution along the gear tooth face width, static strain tests. Formate design only.

the Formate and low-noise designs (Table 2d).

Figure 17 depicts the strain results for the Formate design at all loads tested (50, 75, 100 and 125% torque). As expected, the figure shows a linear increase in stress with torque. The increase is greater at the heel, compared to the toe, for most cases.

Figure 18 compares the dynamic and static stresses for the pinion fillet and root gages for the Formate design at all loads tested. For the most part, the dynamic stresses were about the same—or sometimes less—than the static stresses. This shows a good design from the dynamic standpoint, with no penalties due to dynamic loads.

Bevel tooth contact patterns. As previously reported, the original low-noise designs showed a significant decrease in spiral bevel gear noise, vibration and tooth fillet stress (Refs. 1 and 2). However, a hard-line condition (concentrated wear lines) was present on the pinion tooth flank area for these designs. The improved-bearing-contact, low-noise design corrected this issue (Ref. 8). Figures 19 and 20 show close-up photographs of the pinion and gear, respectively, for the Formate design after completion of all tests to check tooth contact and meshing patterns. No hard-line conditions were found on the pinion and gear tooth flanks.

Summary of Results

Studies to evaluate low-noise, Formate spiral bevel gears were performed. Experimental tests were conducted on the OH-58D helicopter main-rotor transmission in the NASA Glenn 500-hp helicopter transmission test stand. Formate spiral bevel gears were compared to the baseline OH-58D spiral bevel gear design, a high-strength design and previously tested low-noise designs. Noise, vibration and tooth strain tests were performed. The following results were obtained:

1) The Formate spiral bevel design showed a decrease in noise compared to the baseline OH-58D design (about 5 dB at 100% torque), but not as much reduction as previously tested, low-noise designs (about 16 dB at 100% torque). The bevel mesh sound power for the improved-bearing-contact, low-noise design was nearly constant with torque.

2) The Formate spiral bevel design gave the same benefit in reduced vibration—compared to the baseline OH-58D design—as that of the previously tested, low-noise designs. As with the noise test results, the vibration for the Formate design was nearly constant with torque.

3) The spiral bevel pinion tooth stresses for the Formate design showed a significant decrease compared to the baseline OH-58D design, even greater than previously tested high-strength and low-noise designs. Also, the gear stresses significantly decreased compared to the baseline OH-58D design. For the Formate design, the maximum stresses shifted toward the heel, compared to the center of the face width for the baseline, high-strength and previously tested low-noise designs. There was no apparent change in stresses due to dynamic effects for the Formate design.

4) No hard-line conditions were found on the pinion or gear tooth flanks for the Formate design. 

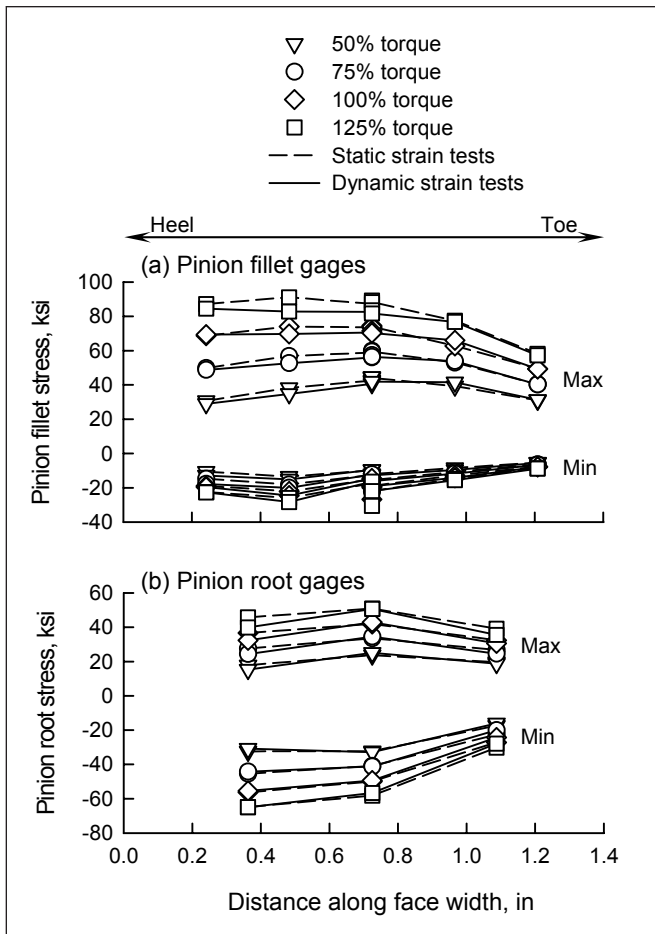

Figure 18—Comparison of static and dynamic strain tests. Fomate design only.



Figure 19—Spiral-bevel pinion tooth contact after tests. Formated design.

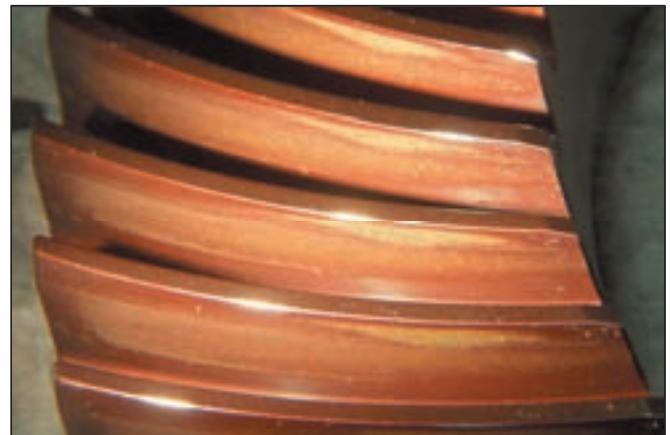

Figure 20—Spiral-bevel gear tooth contact after tests. Formated design.

Acknowledgments

Technical tasks described in this document include tasks supported with shared funding by the U.S. rotorcraft industry and government under the NRTC/RITA Cooperative Agreement No. NCC2-9019, Advanced Rotorcraft Technology, January 1, 2001.

References

1. Lewicki, D.G., R.F. Handschuh, Z.S. Henry and F.L. Litvin. "Improvements in Spiral-Bevel Gears to Reduce Noise and Increase Strength," *Proceedings of the 1994 International Gearing Conference*, Sep. 1994, pp. 341-346.
2. Lewicki, D.G., R.F. Handschuh, Z.S. Henry and F.L. Litvin. "Low-Noise, High-Strength, Spiral-Bevel Gears for Helicopter Transmissions," *AIAA Journal of Propulsion and Power*, Vol. 10, No. 3, May-Jun. 1994, pp. 356-361.
3. Litvin, F.L. and Y. Zhang. "Local Synthesis and Tooth Contact Analysis of Face-Milled Spiral Bevel Gears," NASA CR-4342, 1991.
4. Litvin, F.L., and A. Fuentes. *Gear Geometry and Applied Theory*, 2nd ed., Cambridge University Press, 2004.
5. Litvin, F.L., Y. Zhang and J. Chen. "User's Manual for Tooth Contact Analysis of Face-Milled Spiral Bevel Gears

with Given Machine-Tool Settings," NASA CR-189093, 1991.

6. Litvin, F.L., C. Kuan and Y. Zhang. "Determination of Real Machine-Tool Settings and Minimization of Real Surface Deviation by Computer Inspection," NASA CR-4383, 1991.

7. Fuentes, A., F.L. Litvin, B.R. Mullins, R.L. Woods, R. F. Handschuh and D.G. Lewicki. "Design and Stress Analysis of Low-Noise Adjusted-Bearing-Contact Spiral Bevel Gears," *Proceedings of the International Conference on Gears*, Munich, Germany, Vol. 1, Mar. 2002, pp. 327-340.

8. Lewicki, D.G. and R.L. Woods. "Evaluation of Low-Noise, Improved-Bearing-Contact Spiral Bevel Gears," *Proceedings of the 59th American Helicopter Society Annual Forum*, Phoenix, AZ, May 2003.

9. Krenzer, T.J. "Face Milling or Face Hobbing," American Gear Manufacturers Association Paper No. 90FTM13, 1990.

10. Krenzer, T.J. "CNC Bevel Gear Generators and Flared Cup Formate Gear Grinding," American Gear Manufacturers Association Paper No. 91FTM1, 1991.

11. Litvin, F.L., Q. Fan and A. Fuentes. "Computerized

Design, Generation and Simulation of Meshing and Contact of Face-Milled Formate Cut Spiral Bevel Gears [Final Report],” NASA CR-2001-210894, ARL-CR-467, 2001.

12. Litvin, F.L., A. Fuentes, B.R. Mullins and R. Woods. “Computerized Design, Generation, Simulation of Meshing and Contact, and Stress Analysis of Formate Cut Spiral Bevel Gear Drives; Final Report,” NASA/CR-2003-212336, ARL-CR-525, 2003.

13. Scott, H.W. “Computer Numerical Control Grinding of Spiral Bevel Gears,” 1991, NASA CR-187175, AVSCOM TR-90-F-6.

14. Hirt, M.C.O. “Stress in Spur Gear Teeth and Their Strength as Influenced by Fillet Radius,” Ph.D. Dissertation, Technische Universitat Munchen, 1976, translated by the American Gear Manufacturers Association.

15. Drago, R.J. “Design Guidelines for High-Capacity Bevel Gear Systems,” *AE-15 Gear Design, Manufacturing and Inspection Manual*, Society of Automotive Engineers, 1990, pp. 105-121.

16. Winter, H., and M. Paul. “Influence of Relative Displacements Between Pinion and Gear on Tooth Root Stresses of Spiral Bevel Gears,” 1985, *Journal of Mechanisms Transmissions and Automation in Design*, Vol. 107, pp. 43-48.

This article was originally published by the American Society of Mechanical Engineers (ASME) for the ASME 2007 International Design Engineering Technical Conferences & Computers and Information in Engineering Conference. It is republished here with the permission of ASME.

Dr. David Lewicki is employed by the U.S. Army Research Laboratory’s Vehicle Technology Directorate, located at the NASA Glenn Research Center at Lewis Field in Cleveland, OH. Since 1982, he has conducted analytical and experimental research in transmission, gearing and bearing areas for rotorcraft and turboprop drivetrain applications. His specific areas of research include face gears for helicopter transmissions; low-noise gears; gear crack propagation; gear diagnostics; engine disk crack detection; lubrication; transmission life; reliability predictions; and gear dynamics. Lewicki holds a Ph. D from Case Western Reserve University, has authored or co-authored 100 technical publications addressing the drive system area, and has been government manager for 36 contractor reports. He currently serves as an ASME Fellow, and previously worked as an editor for the *Journal of Mechanical Design*. He has also served as chairman of the ASME power transmission and gearing committee.

Dr. Alfonso Fuentes is a professor of mechanical engineering at the Polytechnic University of Cartagena (UPCT), and was formerly a visiting scholar at the Gear Research Center of the University of Illinois, Chicago (UIC), from 1999 to 2001. His areas of expertise include computerized development of improved gear transmissions for the rotorcraft, automotive and marine industries; development of enhanced computer models of gears for stress analysis; and the design of computer programs for generation and simulation of meshing of low-noise, stable-bearing-contact spiral bevel gears improved geometry. Fuentes is a member of both AGMA and ASME, and serves as associate editor of the *Journal of Mechanism and Machine Theory*, specializing in gears.

Dr. Faydor L. Litvin is an engineering distinguished emeritus professor at the University of Illinois, Chicago (UIC) and an honorable doctor at the University of Miskolc, Hungary. He has conducted research in the theory of gearing, transmission gear design, linkages and manipulators since 1946. Author of more than 350 publications containing 12 monographs, he graduated with distinction in 1937 from Leningrad Polytechnic University. He holds doctorates from Tomsk Polytechnic University (1944) and Leningrad Polytechnic University (1954). He is also the author or co-author of 22 certificates of inventions and four U.S. patents. Among many industry recognitions are: 12 TechBrief certificates of NASA, ASME Thomas A. Edison Patent Award; ASME Best Paper Award; and the Thomas Bernard Hall Prize Award of the Institution of Mechanical Engineers/UK. He is also an ASME fellow and former director of the Gear Research Center at UIC.

Ron L. Woods is employed by Bell Helicopter Textron in Fort Worth, TX, working in the Drive System Analysis Group since 1980. As a technical resource specialist, he is responsible for establishing best practices and for maintaining the state-of-the-art in analytical tools and methods for gear system design and analysis. Specifically, he has been involved in the drive system design of many Bell Helicopter models such as the AH-1W, H-1 upgrade, OH-58D, 407, 427, 430 and, most recently, the 429. He has also been involved in the design of the tiltrotor models V-22, BA609 and the Eagle Eye UAV. Woods holds a Bachelor of Science in mechanical engineering from the University of Texas at Austin, and is a licensed professional engineer in Texas.



www.havlikinternational.com



Czech & Slovak Machine Tools



Gear Machinery



Full Factory Parts & Service



455 Sheldon Dr., Cambridge, ON, N1T 2B7 Tel 519-624-2100 Fax 519-624-6994

havlik@sympatico.ca www.havlikinternational.com



Application of Gears with Asymmetric Teeth in Turboprop Engine Gearbox

Alexander S. Novikov, Alexander G. Paikin, Vladislav L. Dorofeyev, Vyacheslav M. Ananiev, Alexander L. Kapelevich

Management Summary

This paper describes the research and development of the first production gearbox with asymmetric tooth profiles for the TV7-117S turboprop engine. The paper also presents numerical design data related to development of this gearbox.

Table 1—Main parameters of the TV7-117S gearbox (Refs. 9,10).

Input Turbine RPM	17,500
Output Prop RPM	1,200
Total Gear Ratio	14.6:1
Overall Dimensions, mm: - Diameter - Length	520 645
Gearbox weight, N	1,050
Cruise Transmitted Power, hp	2,500
Maximum Transmitted Power, hp	4,000

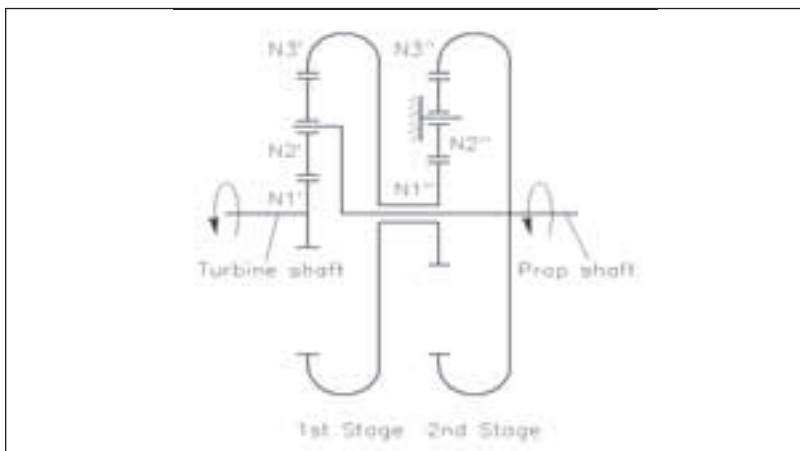

Figure 1—The TV7-117S gearbox arrangement.

Introduction

The benefits of gears with asymmetric tooth profiles for unidirectional torque transmission are well known. There are many publications on the subject. E.B. Vulgakov (Ref. 1) has developed geometry of gears with asymmetric involute teeth, presenting the asymmetric tooth as a combination of two halves of different symmetric teeth without using any generating rack. A.L. Kapelevich (Refs. 2–3) presented an asymmetric tooth by two involutes from different base diameters, which expanded the previous achievable range of the gear mesh parameters, such as the operating pressure angle and contact ratio. C. A. Yoerkie and A. G. Chory (Ref. 4) have researched acoustic vibration characteristics of high-contact-ratio planetary gears with asymmetric buttress teeth in comparison with symmetric teeth. I. A. Bolotovskiy, et al., G. DiFrancesco and S. Marini, D. Gang and T. Nakanishi, and F. Karpat, et al. (Refs. 5–8) researched gears with asymmetric teeth based on the generating rack, a common research method for conventional gears with symmetric teeth.

In all these and other related publications, however, mathematical modeling and lab specimen testing usually limit practical implemen-

tations of gears with asymmetric tooth profiles.

This paper is dedicated to the application of gears with asymmetric tooth profiles in the gearbox of the TV7-117S turboprop engine. This engine was used in the Russian airplane IL-114 for several years and is going to be used in IL-112, MIG-110 and TU-136 airplanes. The gearbox was developed by the Klimov Corporation (St. Petersburg, Russia) and Gear Transmission Department of CIAM (Central Institute of Aviation Motors), Moscow, Russia. The gears with asymmetric teeth were designed non-traditionally, without using the basic or generating rack. This design method is based on the Theory of Generalized Parameters, developed by Prof. E.B. Vulgakov (Ref. 1) and is now known as Direct Gear Design.

Gearbox Data

Main parameters of the TV7-117S gearbox (Refs. 9, 10) are presented in Table 1.

The TV7-117S gearbox arrangement (Fig.1) is the same as in previous-generation AI-20 and AI-24 turboprop engines. This arrangement has proved to provide maximum power transmission density for the required total gear ratio.

The first planetary-differential stage has three planet gears. The second coaxial stage has five planet (idler) gears and a stationary carrier. Part of the transmitted power goes from the first stage carrier directly to the propeller shaft. The rest of the transmitted power goes from the first-stage ring gear to the second-stage sun gear, and then through the planets to the second-stage ring gear, also connected to the propeller shaft.

Gear Geometry

Asymmetric gear tooth profiles (see Fig. 2) were chosen to increase power transmission density and reduce gear noise and vibration (Ref. 11).

Direct Gear Design develops the asymmetric tooth form by using two involutes of two different base circles, as shown in (Fig. 3). The equally spaced teeth form the gear. The fillet between teeth is not in contact with the mating gear teeth. However, this portion of the tooth profile is also designed independently, providing minimum bending stress concentration and sufficient clearance with the mating tooth tip in mesh.

The asymmetric gear mesh (Fig. 4) presents two different drive and coast flank meshes with different pressure angles and contact



Figure 2—First-stage sun gear with asymmetric teeth.

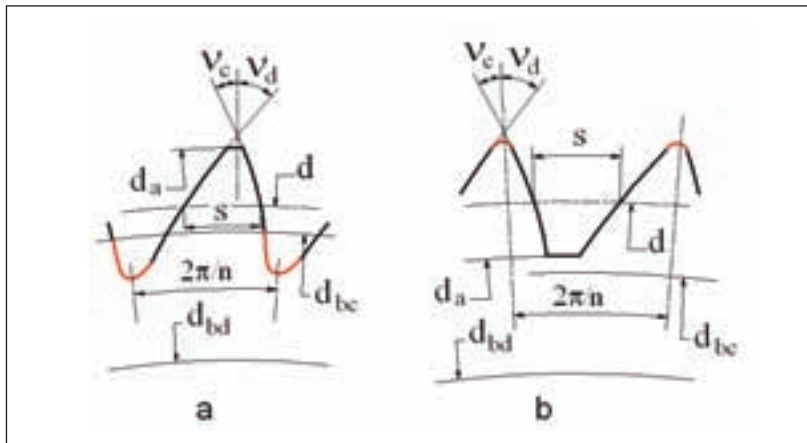

Figure 3—Asymmetric tooth profile (the fillet portion is red); a—external tooth; b—internal tooth; d_a —tooth tip circle diameter; d_b —base circle diameter; d —reference circle diameter; S —circular tooth thickness at the reference diameter; v —involute intersection profile angle; subscripts “a” and “c” are for the drive and coast flanks of the asymmetric tooth.

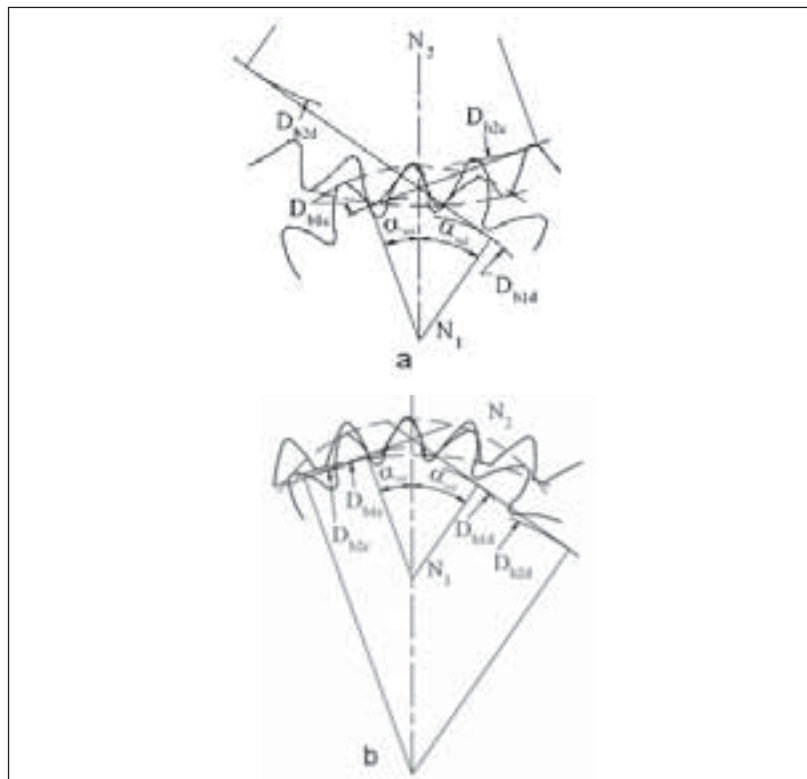

Figure 4—Asymmetric gear mesh; a—external gearing; b—internal gearing; α_w —operating pressure angle; $D_{b1,2}$ —operating pitch circle diameters; subscripts “1” and “2” are for the mating pinion and the gear.

Table 2	
Equation 1- for external gearing	
$\text{inv } \alpha_{wd} + \text{inv } \alpha_{wc} = [\text{inv } v_{1d} + \text{inv } v_{1c} + u * (\text{inv } v_{2d} + \text{inv } v_{2c}) - 2 * \pi / n_1] / (1 + u)$	
$\epsilon_{ad} = n_1 * [\tan \alpha_{a1d} + u * \tan \alpha_{a2d} - (1 + u) * \tan \alpha_{wd}] / (2 * \pi)$	
$\epsilon_{ac} = n_1 * [\tan \alpha_{a1c} + u * \tan \alpha_{a2c} - (1 + u) * \tan \alpha_{wc}] / (2 * \pi)$	
Equation 2- for internal gearing	
$\text{inv } \alpha_{wd} + \text{inv } \alpha_{wc} = [u * (\text{inv } v_{2d} + \text{inv } v_{2c}) - \text{inv } v_{1d} - \text{inv } v_{1c}] / (u - 1)$	
$\epsilon_{ad} = n_1 * [\tan \alpha_{a1d} - u * \tan \alpha_{a2d} + (u - 1) * \tan \alpha_{wd}] / (2 * \pi)$	
where $u = n_2 / n_1$ is a gear ratio	

Table 3—Basic gear geometry parameters.				
First Stage				
Gear	Sun Gear	Planet Gear	Ring Gear	
Number of Gears	1	3	1	
Number of Teeth	28	41	107	
Center Distance, mm	103.500			
Operating Module, mm	3.000		3.044	
Operating Pressure Angle, deg.	Drive Flank	33		29.9
	Coast Flank	25		36.66
Drive Flank Operating Contact Ratio	1.29			1.46
Second Stage				
Gear	Sun Gear	Planet Gear	Ring Gear	
Number of Gears	1	5	1	
Number of Teeth	38	31	97	
Center Distance, mm	116.000			
Operating Module, mm	3.362		3.412	
Operating Pressure Angle, deg.	Drive Flank	33		29.9
	Coast Flank	25		36.66
Drive Flank Operating Contact Ratio	1.29			1.46

ratios. The operating pressure angle α_w and the contact ratio ϵ_α for the gear with asymmetric teeth are defined by the formulae in Table 2 (Ref. 3):

In propulsion gear transmissions, the tooth load on one flank is significantly higher and is applied for longer periods of time than the opposite one. An asymmetric tooth shape reflects this functional difference. Design intent of asymmetric gear teeth is to improve performance of the primary drive profiles by some degrading performance of the opposite coast profiles. The coast profiles are unloaded or lightly loaded during a relatively short work period. Asymmetric tooth profiles also make it possible to simultaneously increase the contact ratio and operating pressure angle beyond the conventional gears' limits. In planetary gear systems, the planet gear is usually in simultaneous contact with the sun and ring gears. The tooth load and number of the load cycles are equal for both flanks of the ring gear. However, one flank of the planet gear is in mesh with the concave tooth flank of the ring gear with internal teeth. The resulting contact stress in this mesh is much lower in comparison with contact stress of the convex tooth flanks in sun-planet gear contact, which defines the load capacity and size of the gears. In order to reduce this contact stress, the higher operating pressure angle was chosen for the sun-planet gear contacting tooth flanks. This choice is in compliance with the ANSI/AGMA 6123-B06 standard "Design Manual for Enclosed Epicyclic Gear Drives," which states: "Best strength-to-weight ratio is achieved with high operating pressure angles at the sun-to-planet mesh, and low operating pressure angles at the planet-to-ring gear mesh."

The drive tooth flanks of the sun-planet gear mesh have increased the contact curvature radii, resulting in greater hydrodynamic oil film thickness. This also reduces contact stresses, because the increased relative curvature increases the tooth contact area. Basic gear geometry parameters are presented in Table 3.

Direct Gear Design of the asymmetric tooth profiles also allows shaping the coast flanks and fillet independently from the drive flanks, reducing tooth stiffness and improving load sharing while keeping a desirable pressure angle and contact ratio on the drive profiles. This allows both increasing tooth tip deflection

and damping tooth mesh impact, leading to gear noise and vibration reduction.

$$\alpha_{wd2-3} = \arccos [\cos (\alpha_{wc1-2}) * (n_3 - n_2) / (n_1 + n_2)] \quad (3)$$

Where

α_{wc1-2} - coast operating pressure angle in the sun-planet gear mesh;

n_1 - sun gear number of teeth;

n_2 - planet gear number of teeth;

n_3 - ring gear number of teeth.

The geometry of asymmetric teeth does not allow using the traditional Lewis equation to define the tooth bending stress. Initially the photoelastic models (Fig. 5a) were used for the bending stress definition. Later FEA (Fig. 5b) allowed evaluating stress level more efficiently.

Gear Manufacturing and Assembly

All gears are made from forged blanks of the steel 20KH3MVF (EI-415). Its chemical composition includes: Fe - base material, C (0.15–0.20%), S (<0.025%), P (<0.030%), Si (0.17–0.37%), Mn (0.25–0.50%), Cr (2.8–3.3%), Mo (0.35–0.55%), W (0.30–0.50%), Co (0.60–0.85%), and Ni (<0.5%).

Machining of the directly designed sun and planet gears with asymmetric teeth requires custom gear hobs. The hob rack profile is defined by reverse generation of the gear profile. It is similar to the gear rack profile generated by a shaper cutter when this cutter is replaced by the asymmetric gear profile. Custom shaper cutters are used to machine the ring gear with internal teeth. Their profiles are also defined by reverse generation based on the ring gear geometry. The gear blank position during machining must provide the asymmetric teeth pointed in either the clockwise or counterclockwise direction. Otherwise, the drive flank of one gear will be positioned in contact with the coast profile of the mating gear, and assembly would be impossible.

After tooth cutting, the gears are carburized and heat-treated to achieve tooth surface hardness > 59 HRC with the case depth of 0.6–1.0 mm. The core tooth hardness is 33–45 HRC. Final gear machining includes tooth grinding and honing. Asymmetric gear flanks require special setup for both these operations.

Assembly of the gearbox includes selection of planet gears and their initial orientation, which is based on the transmission error function of every gear. All planet gears are classified by the transmission error (TE) function in several groups. Each group has planet gears

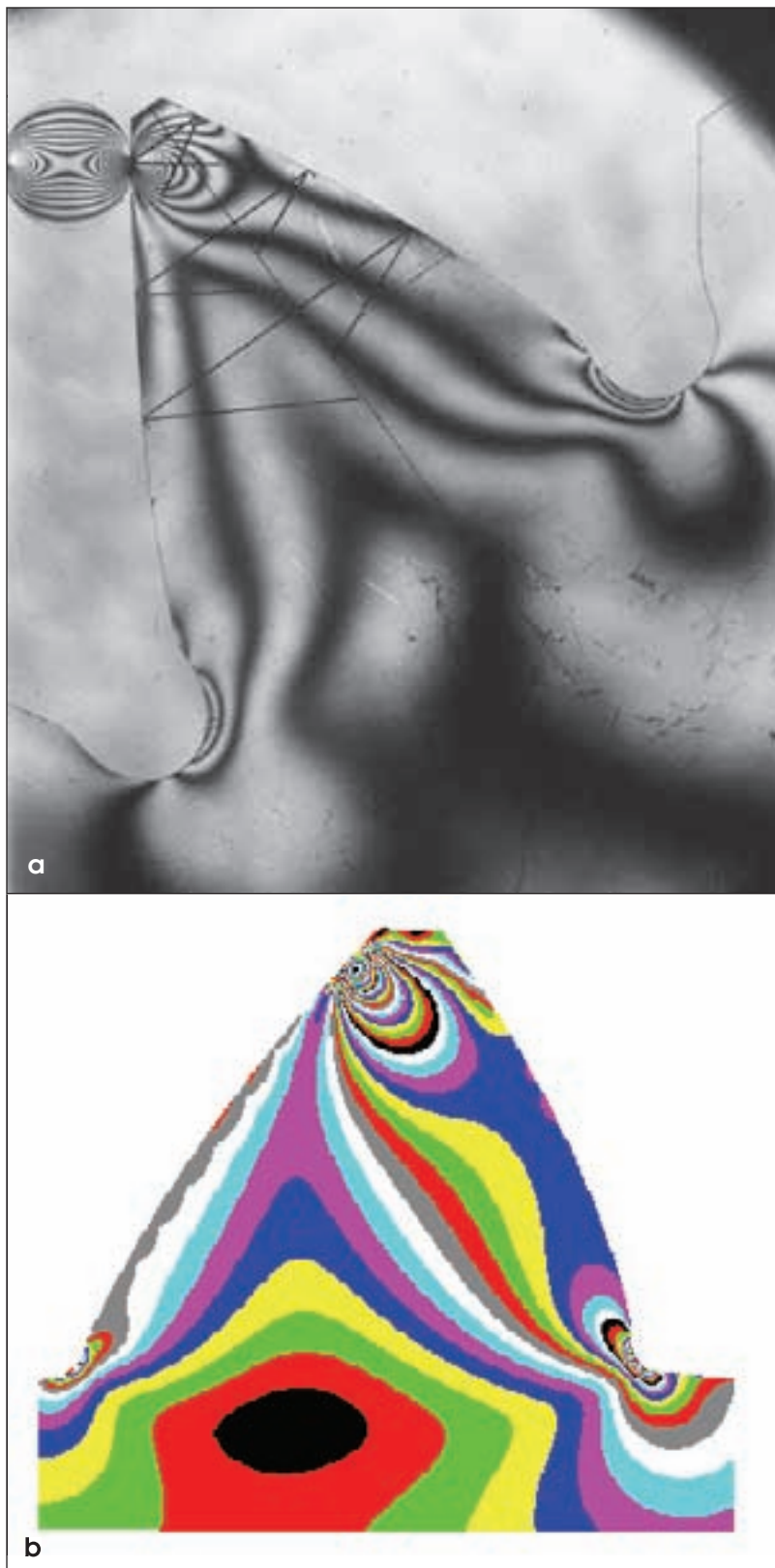

Figure 5—Asymmetric tooth; a—photoelastic model, b—stress isograms as a result of FEA.



Figure 6—First-stage sun gear assembly.



Figure 7—First-stage carrier and ring gear assembly.



Figure 8—Second-stage sun gear.



Figure 9—Second-stage carrier assembly.

with similar TE function. Position and orientation of each planet gear are assembled depending on its TE function profile, providing better engagement of the driving flanks and load distribution between planet gears (Ref. 12).

The TV7-117S turboprop engine gearbox components and assemblies are presented in Figs. 6–10.

Summary

Application of the asymmetric teeth helped to provide extremely low weight-to-output torque ratio, significantly reduced noise and vibration levels—with less duration—and lower expense of operational development. Table 4 presents comparison of some characteristics of the TV7-117S gearbox with the gearboxes of its predecessors AI-20 and AI-24 turboprop engines (Ref. 12).

The new design and technological approaches that have found their realization in the TV7-117S engine gearbox were recommended for development of the gearboxes for advanced aviation engines. 

References:

1. Vulgakov, E. B. “Gears with Improved Characteristics,” *Mashinostroenie*, 1974 (in Russian).
2. Kapelevich, A. L. “Research and Development of Geometry of Modernized Involute Gears,” Ph.D. Thesis, Moscow Bauman State Technical University, Moscow, Russia, 1984.
3. Kapelevich, A. L. “Synthesis of Asymmetric Involute Gearing,” *Mashinostroenie* No. 1, pp. 62–67. Translated to English in Soviet Machine Science, Allerton Press, Inc., 1987, No 1, pp. 55–59.
4. Yoerkie, C.A. and A.G. Chory. “Acoustic Vibration Characteristics of High Contact Ratio Planetary Gears,” *The Journal of American Helicopter Society*, Vol. 40, 1984, pp. 19–32.
5. Bolotovskiy, I.A., O.F. Vasil’eva and V.P. Kotelnikov. “Involute Gears with Asymmetric Teeth,” *Vestnik Mashinostroeniya*, Issue 4, 1984, pp. 15–17.
6. DiFrancesco, G. and S. Marini. “Structural Analysis of Asymmetrical Teeth: Reduction of Size and Weight,” *Gear Technology*,

September/October 1997, pp. 47–51.

7. Gang, G. and T. Nakanishi. “Enhancement of Bending Load Carrying Capacity of Gears Using an Asymmetric Involute Tooth,” The JSME International Conference on Motion and Transmissions (MPT2001-Fukuoka), Fukuoka, JAPAN, 2001, pp. 513–517.

8. Karpat, F., K. Cavdar and F.C. Babalik. “Computer-aided Analysis of Involute Spur Gears with Asymmetric Teeth,” VDI Berichte, 1904 I, 2005, pp. 145–163.

9. Vulgakov, E.B. and A.A. Sarkisov. “The New Gearbox of Klimov Corporation,” *Aerospace Courier*, Issue 2, 2000, pp. 32–33.

10. Vulgakov, E.B. and A.L. Kapelevich. “The Gearbox for the TV7-117S Turbo-prop Engine,” *Vestnik Mashinostroeniya*, 2000, Issue 11, pp. 13–17.

11. Kapelevich, A.L. “Geometry and Design of Involute Spur Gears with Asymmetric Teeth,” *Mechanism and Machine Theory*, 2000, Issue 35, pp. 117–130.

12. Vulgakov, E.B., et al. *Aviation Gearboxes, Handbook, Mashinostroenie*, Moscow, 1981.

This article was originally published by the American Society of Mechanical Engineers (ASME) for the ASME 2007 International Design Engineering Technical Conferences & Computers and Information in Engineering Conference. It is republished here with the permission of ASME.



Figure 10—Gearbox assembly.

Table 4—Presents comparison of some characteristics of the TV7-117S gearbox with gearboxes of its predecessors AI-20 and AI-24 turboprop engines (Ref. 12).			
Gearbox	AI-20	AI-24	TV7-117S
Gear Ratio	11.4:1	12.1:1	14.6:1
Maximum Output Torque, Nm	24,080	13,450	23,840
Gearbox weight, N	2,350	1,100	1,050
Weight-Torque Ratio N/Nm	0.0985	0.0818	0.0440
Gearbox Oil Temperature, °C	90	90	90

Dr. Vyacheslav M. Ananiev is a lead scientific researcher of the Central Institute of Aviation Motors (CIAM), Moscow, Russia. CIAM is a specialized Russian research and engineering facility dealing with advanced aerospace propulsion research, aircraft engine certification and gas dynamics-related issues. Dr. Ananiev is a prominent gear expert in the Russian aerospace industry.

Dr. Vladislav L. Dorofeyev is a lead designer of the gear transmissions department of the Federal State Unitary Enterprise at the Moscow Machine Building Production Plant “Salut.” “Salut” is a specialized enterprise for the production and maintenance of engines for Russian military and commercial aircrafts. Dr. Dorofeyev is also a professor at the Moscow State Aviation Technological University named after K.E. Tsiolkovsky.

Dr. Alexander L. Kapelevich is president of the gear design consulting firm AKGears, LLC, located in

Shoreview, Minnesota, USA. Working in the CIAM in the 1980s, he optimized the asymmetric tooth geometry for the TV7-117 engine gearbox. He is also a developer of the Direct Gear Design method. Dr. Kapelevich is an active member of the AGMA aerospace and plastic gearing committees.

Dr. Alexander S. Novikov is general director of the Moscow Machine-Building Plant named after V.V. Chernyshev, Moscow, Russia. The Moscow Machine-Building Plant manufactures and overhauls a number of aero engines for military and commercial aircrafts, including the TV7-117S turboprop engine. Mr. Novikov executes the general management of the company.

Dr. Alexander G. Paikin is a general engineer of the Moscow Machine-Building Plant named after V.V. Chernyshev, Moscow, Russia. Mr. Paikin executes the technical management of the company.

Gear Up Your Quality Control

RoboScan – automatic Barkhausen Noise inspection system for spur and helical gears

RoboScan system greatly improves grinding quality control of gears and reduces labor time and cost. The system provides grinding inspection based on Barkhausen Noise with minimum operator involvement. Gears are loaded into the system, and the robot takes care of the measurements. Many different surfaces can be measured effectively as the robot selects and uses a variety of sensors automatically. All results are documented on a PC and displayed on the monitor.

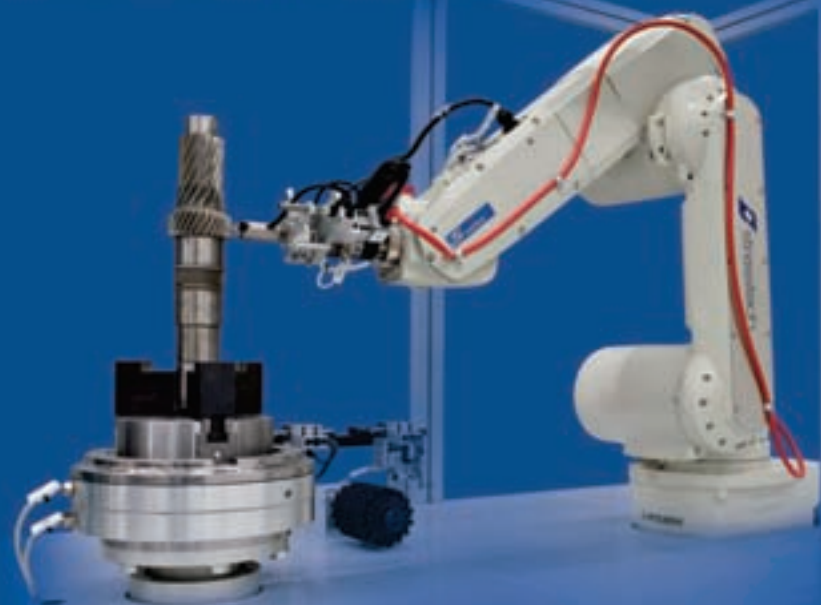

SOLUTIONS AND INSTRUMENTS FOR

- Automated grinding burn detection systems
- Automated heat treat defect detection
- X-ray diffraction and Electron speckle pattern interferometry (ESPI) for residual stress measurements
- X-ray diffraction for retained austenite measurements



www.stresstechgroup.com

American Stress Technologies, Inc.
840 Watercrest Way
Cheswick, PA 15024
USA
Tel. +1-724-410 1030
Fax +1-724-410 1031
info@astresstech.com
www.astresstech.com

Stresstech Oy
Tikkutehtaantie 1
40800 Vaajakoski
FINLAND
Tel. +358-14-333 000
Fax +358-14-333 0099
info@stresstech.fi
www.stresstechgroup.com

Stresstech GmbH
Bahnhofstrasse 39
D-55462 Höhn
GERMANY
Tel. +49-2661-91570
Fax +49-2661-915755
info@stresstech.de
www.stresstech.de

AGMA JOINS IFPE FOR EXHIBIT PAVILION



The American Gear Manufacturers Association (AGMA) is sponsoring an exhibit pavilion for its members at the 2008 International Exposition for Power Transmission (IFPE). The exposition is the largest technical conference for hydraulic, pneumatic, electrical and mechanical power transmission components, systems and controls. IFPE 2008 will run from March 11-15 at the Las Vegas Convention Center in Las Vegas, Nevada.

"AGMA has been a supporting organization for IFPE in the past," says Sara Truesdale-Mooney, IFPE show manager. "We thought it would be a good idea to have AGMA become a sponsoring organization, and to feature the mechanical side of things this year."

The show is primarily for design engineers, purchasing managers, and other high-level executives looking for the latest technologies in power transmission, components and systems

and controls for mobile equipment applications.

"This partnership provides exposure for the gear industry," says Kurt Medert, AGMA vice president. "It's also beneficial for AGMA from a broader perspective, in the same way that exhibiting in the international wind energy show and the Hannover Fair help AGMA members find new business opportunities."

Mooney believes the partnership will continue between AGMA and the IFPE in the future. "We hope to build on this relationship for future exhibitions; it's beneficial for both our attendees as well as AGMA members."

Linda Western, executive director of the National Fluid Power Association (NFPA) is pleased with AGMA's participation in the show. "Industry partnerships such as this strengthen IFPE's scope and are a key to its success," says Western.

IFPE 2008 is running simultaneously with CONEXPO-CON/AGG 2008, the largest international gathering place in 2008 for the construction industries. The shows are expected to attract more than 125,000 visitors from around the world.

Along with the AGMA-sponsored pavilion, the IFPE is offering from the Power Transmission Distributors Association (PTDA) as well as that highlights sensor suppliers. Pavilions sponsored by China, Italy, Spain and Taiwan offer international business solutions and contacts.

AGMA has scheduled its 2008 Annual Meeting in Las Vegas from March 8-10, giving its members the opportunity to stay for the exhibition. Although IFPE is sold out, Mooney says there is a waiting list for interested parties on a first come/first serve basis. For more information call (414) 298-4141, toll free (800) 867-6060 or visit www.ifpe.com.

Solar's VACUUM CARBURIZING SEMINAR

Solar Atmospheres of Western PA will host a free seminar on the developments and applications of vacuum carburizing. The event will be held on Thursday, April 17th, at the company's Hermitage, PA facility. According to a Solar press release, the three-hour seminar will include a tour of the 65,000-square-foot plant—focusing on the vacuum carburizing area—as well as a look at what the company states are the world's largest commercial vacuum furnaces.

The course outline will include talks given by Bob Hill, president of Solar Atmospheres; Trevor Jones, project engineer; and Don Jordan, vice president of Solar's Technical Center, located in Souderton, PA. Topics to be covered will include the "History of Traditional Carburizing," "Vacuum Carburizing Furnace Development" and "Benefits and Applications of Vacuum Carburizing." The seminar, which includes lunch, will start at 9:00 a.m., concluding at 1:00 p.m.

RSVP and confirmation by Solar is required by April 11. Contact Lori Wansack at (866) 982-0660, Ext. 238 to make your reservation, or email lori@solaratm.com. Includes lunch, will start at 9:00 a.m., concluding at 1:00 p.m.

RSVP and confirmation by Solar is required by April 11. Contact Lori Wansack at (866) 982-0660, Ext. 238 to make your reservation, or email lori@solaratm.com.

February 15-18—Tooltech. Bangalore International Exhibition Center, Bangalore, India. India's premier exhibition on cutting tools, tooling systems and machine tool accessories focuses on industry issues from technology and design to quality and production. The Association for Manufacturing Technology's (AMT) team will be on hand to provide data information for the Indian market. For more information, contact Knox Johnstone at (703) 827-5224.

February 20-21—AGMA Gear Accuracy Committee. Orlando, Florida. Members of this committee will gather to discuss topics including the development of AGMA 2002-CXX, tooth thickness specification and measurement, and new standards on spur and helical gear accuracy. For more information, visit www.agma.org or call AGMA headquarters at (703) 684-0211.

February 28—Makino's How to Get the Most Out of Your Work Zone Webinar. Makino's online seminar provides an emphasis on greater productivity and quality by maximizing utilization of the entire work zone of a horizontal machining center. From design to processing techniques and technologies, attendees will learn how to achieve accurate results, even while cutting high in the Y-axis. Each webinar consists of a 20-45 minute presentation followed by a Q&A session with the speaker. Registration is required, but webinars are free of charge. For more information, visit www.makino.com/events.

February 28-29—AGMA Cutting Tools Committee. The committee will meet to advance their work on AGMA 1104-AXX, a tolerance specification for shaper cutters. They will also determine the U.S. position on international standards being developed on cutting tool accuracy. For more information, e-mail Amy Lane at lane@agma.org or

call AGMA headquarters at (703) 684-0211.

March 4-6—Expo Manufactura Cintermex. Cintermex, Monterrey, Mexico. Heading into its 14th year, the Expo Manufactura is designed for metalworking and manufacturing professionals in machine tools, automation, assembly, robotics, lasers and welding/welding processes. For more information including registration, visit www.ejkrause.com.

March 12-13—Lean for the Supply Chain. Crown Plaza Hotel, San Jose, California. An SME event designed to provide manufacturers with a plan to use lean principles and tools to survive and thrive in their supply chain. Each attendee will leave with a document that maps out strategies (Plan, Do, Check, Act) to continue utilizing lean principles. For more information, contact the SME Resource Center at service@sme.org.

March 27—Makino's 5-Axis Machining Solutions Webinar. Makino's online seminar introduces advantages of five-axis machining, including how new levels of sustained dynamic accuracy are achieved. Attendees will also learn how five-axis machining can improve part quality and maximize manufacturing input. Registration is required, but webinars are free of charge. For more information, visit www.makino.com/events.

March 26-27—Advanced Manufacturing Expo. International Centre, Toronto, Ontario. Two events form the basis for the Advanced Manufacturing Expo—the Canadian High-Technology Show (CHTS) and Assembly Canada. Both programs feature education sessions as well as innovations on the showroom floor. Attendees will learn, compare and implement operation solutions. Assembly Canada concentrates on the assembling of discrete parts into finished products, while the Canadian High-

Technology Show focuses on products and services for electronics manufacturing. The Society of Manufacturing Engineers sponsors the event. For more information contact Lori Ann Dick, senior public relations representative, at communications@sme.org.

March 31-April 3—WESTEC 2008 Exposition and Conference. Los Angeles Convention Center, Los Angeles, CA. With a focus on technology and professional advancement, WESTEC offers free educational programs including sessions on comparative technologies, lean principles and business management strategies in manufacturing. This year's conference features a back-to-basics program offering manufacturing career opportunities. The Society of Manufacturing Engineers sponsors the event. For more information contact Lori Ann Dick, senior public relations representative, at communications@sme.org.

ONLINE

Visit
www.geartechnology.com
 for the latest
 Industry Events



Leading the World in Induction Heating Technologies.



Inductoheat has been leading the world in induction heating technologies for over 40 years by offering product lines ranging from general purpose machines to custom engineered, fully automated induction heating systems. With global technical support, our engineering excellence has no boundaries. Whether you're performing heat treating, forging, or another thermal process, Inductoheat can put the heat where you need it for quality parts.

- **Induction heat treating & forge heating equip.**
- **Revolutionary power supply design**
- **Process development & met. lab.**
- **Inductor design, build & repair dept.**
- **Aftermarket support & service dept.**
- **24-hour hotline: 888/241-8386**

For more information, call 800/624-6297 or visit www.inductoheat.com

Inductoheat, Inc.
32251 N. Avis Dr.
Madison Heights, MI 48071



**INDUCTOTHERM
GROUP**

Leading Manufacturers of Melting, Thermal Processing &
Production Systems for the Metals & Materials Industry Worldwide.

Induction Heating Seminar

LEADS TO BIG PLANS IN 2008



The first Mexican induction heating and NDT seminar, held at the Plaza Camelinas Hotel in Queretaro, Mexico, featured several world-recognized experts of induction technology. Topics included electromagnetic and metallurgical aspects of induction heating, heat-treating and forging, troubleshooting, case studies and solutions, modern power supplies, monitoring and non-destructive testing.

According to Dr. Valery Rudnev from Inductoheat, a program entitled, "Intricacies of Induction Hardening and Tempering of Gears and Critical Components," was originally scheduled to be a 35-minute presentation.

"Due to numerous requests we extended the subject," says Rudnev. "It became a 50-minute lecture on the different aspects of induction heat treatment of gears including materials, microstructure, modes of induction heating ("tooth-by-tooth," "gap-by-gap," spin hardening, etc.), power control modes, stresses, hardening profiles, electromagnetics, computer modeling, etc."

David Popkey, manager of international sales at Inductoheat, was pleased with the turnout at the event. "We had a full house for the program. The Q&A session went two hours longer than we expected, which was a pleasant surprise."

Rudnev agreed. "The most impressive part was that nobody disappeared during the seminar. Due to the overwhelming amount of questions, we stayed longer at the end of each day."

Inductoheat, Incotec and IBG sponsored the seminar in

a joint effort that included more than 50 attendees from 15 automotive heating, heat-treating and forging companies.

According to the company's press release, demand for more information has led Inductoheat to plan additional seminars for 2008 in Monterrey and Mexico City. For more information, visit www.inductoheat.com.

MAG Powertrain

INSTALLS MQL SYSTEM FOR FORD

MAG Powertrain is installing a Minimum Quantity Lubrication (MQL) machining system at the Ford Van Dyke Transmission Plant in Sterling Heights, Michigan. This is the second MQL system without any wet machining operations at the plant. A hybrid system is also in place to produce aluminum transmission cases, converter housings and valve bodies for Ford's six-speed transmissions. The new MQL system is scheduled for completion by the end of 2007.

According to the company's press release, MQL systems reportedly yield yearly savings of approximately 30,000 gallons of coolant oil, with water reduction of more than 250,000 gallons and large reductions in requirements for compressed air usage.

In a MQL system, a fine oil mist replaces the traditional coolant flooding used to lubricate and cool the cutting tool and workpiece. Chips are evacuated through the use of an integrated vacuum and safety system. Property algorithms

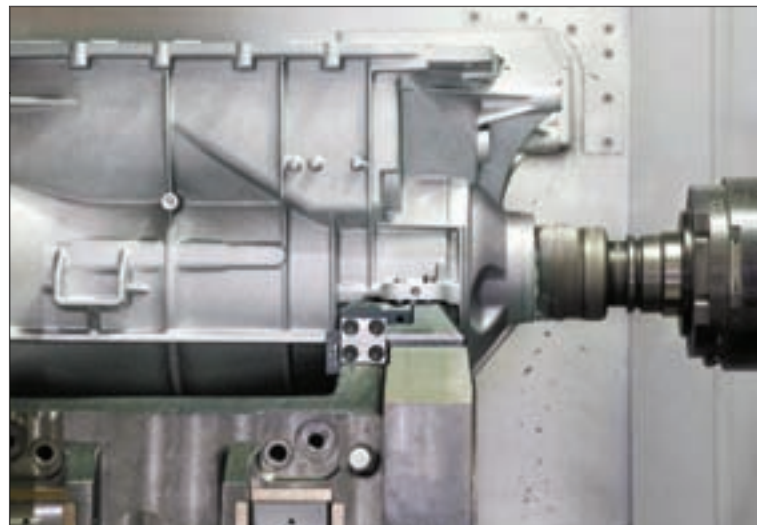

work together with temperature monitoring to eliminate heat-related distortion.

The new system at the Van Dyke plant will include 52 MAG Powertrain SPECHT horizontal 4- or 5-axis machining centers, designed for medium- to high-volume production applications. Each operation can have its own lubricity level as opposed to a centralized coolant system. The machines can also be moved easily as production requirements change.

MAG Powertrain designs and builds manufacturing systems for automotive, diesel and heavy industrial machinery. For more information on their MQL systems, visit www.mag-ias.com.

Performance Gear

CELEBRATES 10 YEARS OF OPERATION

Performance Gear Systems Inc. celebrated its 10th year in business on October 31, 2007. The company began as a gear design and consulting operation before becoming a molded gear manufacturer.

While other molding operations moved to offshore facilities, Performance Gear continued to grow as a specialty gear molder in the United States. Repeat business and new accounts have spurred the growth.

According to Keith Hansen, marketing director at Performance Gear, the methods of design, quality, inspection and manufacturing are specific to plastic gears. "We take our customers' proprietary design very seriously. After all, the gears are normally the heart of our customers' mechanism."

Encore Group

JOINS DURA-BAR DISTRIBUTORS

Dura-Bar, the only North American producer of continuous cast iron bar stock, recently announced the addition of the Encore Group of Edmonton, Alberta as a distributor. The Encore Group consists of Encore Metals and Team Tube in Canada. It's a subsidiary of the Reliance Steel and

continued



setco
RESET | Repair & Rebuild Services

Expert Spindle Repair, Rebuild & Retrofit Services

- ▶ Most Any Make & Model
- ▶ Belt-driven, CNC, Gear-driven & Motorized Designs
- ▶ Emergency Repair Services!
- ▶ Visit Our Website and **Save \$100**
www.setcousa.com

Western Service Center
5572 Buckingham Drive
Huntington Beach, CA 92649
800-362-0699 Toll Free
714-372-3730 Ph
714-372-3750 Fax

Great Lakes Service Center
41180 Vincent Court
Novi, MI 48375
877-773-5349 Toll Free
248-888-8989 Ph
248-888-0785 Fax

Midwest Service Center
5880 Hillside Avenue
Cincinnati, OH 45233
800-543-0470 Toll Free
513-467-7262 Ph
513-467-7249 Fax

setco
Set for Life

Yesterday's Reliability Tomorrow's Technology



Fifty years of VARI-ROLL applications provide:

- Production Composite Inspection
- Custom Design & Build Part Gear Mounting Fixtures
- Standard Mounting Fixtures — Spurs, Helicals, Pinion Shafts, Worms, Throated Worms, Bevels, Internals

When coupled with the VARI-PC Composite Gear Analysis System will provide:

- Reduced Inspection Cost
- Improved Accuracy
- Historical Record Keeping
- Serialization of Parts
- Interface to SPC programs

Experience the difference. See why customers worldwide have chosen the VARI-ROLL/VARI-PC. For further information, please contact us.

VARI-ROLL
Precision Gage Co., Inc.
100 Shore Drive Burr Ridge, IL 60527
630-655-2121 Fax 630-655-3073
www.precisiongageco.com



TOPOLOGICAL GEAR GRINDING



Advanced topological gear grinding, based on MAAG 0° grinding system.

With levels up to CNC.

Applicable for:

- Shaving cutters
- Dressing tools
- Prototype gears
- Master gears
- etc.

Donner + Pfister AG
Switzerland

Tel: +41554402032
info@dpag.ch
www.dpag.ch

NEWS

Aluminum Company.

According to the company's press release, the Encore Group will be able to supply Dura-Bar's continuous cast gray and ductile iron bar stock in a wide variety of shapes and sizes.

"We're pleased to welcome the Encore Group to our distribution network," says Frank Abruzzo, Dura-Bar's vice president of sales and marketing. "Encore's 17 locations and processing capabilities will benefit Dura-Bar users in those areas."

Niagara Gear

EXPANDS PLANT IN NEW YORK

A recent 8,000-square-foot expansion project at Niagara Gear Corporation in Buffalo, New York, brings the total plant size to more than 30,000 sq. feet. The completed project features a gear cutting center, gear grinding department and new manufacturing and engineering offices.

According to the company's press release, the facility will allow the company to implement a time-efficient inventory

GEAR CUTTING TOOLS

MADE IN SWITZERLAND



SCHNYDER **HANIK**
CORPORATION
GEAR CUTTING TECHNOLOGY
60 YEARS OF TOP TECHNOLOGY

US Distributor
PHONE 630-595-7333
FAX 630-595-7343
www.hanikcorp.com
email: hanikcorp@aol.com

ph: 011-41-32-344-0400 • fax: 011-41-32-344-0404 • www.schnyder.com • mail@schnyder.com



system aimed at improving workflow. The expanded space also gives Niagara the ability to add new equipment, such as a recently purchased CNC cylindrical grinding machine.

“The expansion opens the door for future capital equipment purchases because we now have the floor space to do it,” says Robert Barden, vice president and general manager at Niagara Gear Corporation. “This signifies positive growth for Niagara Gear.”

ECM

COMMEMORATES 10 YEARS IN UNITED STATES

ECM, a manufacturer of vacuum carburizing furnaces, recently announced its ten-year anniversary in the United States. The U.S. headquarters, located in Kenosha, Wisconsin is set up for testing customer programs with full metallurgical support. ECM USA focuses on low-pressure vacuum carburizing in North America with a concentration on sales, installation and service operations. While its main headquarters is located in France, the company has offices in the United States, China and Japan as well as representatives in Mexico and South America.

Marposs

ACQUIRES CONTROL GAGING INCORPORATED

Marposs S.p.A. of Bologna, Italy recently announced the acquisition of Control Gaging Incorporated of Ann Arbor, Michigan. According to the company’s press release, existing CGI management and personnel will be retained.

“CGI and Marposs are industry leaders in gaging and process control systems for manufacturing industries world-

continued



NUMBER ONE FOR ROTARY BROACHING

SMALL FORM GEAR CUTTING TOOLS

<p style="text-align: center; color: #c00;">INTERNAL/EXTERNAL BROACH HOLDERS</p> <div style="text-align: center; border: 1px solid gray; padding: 5px; margin-bottom: 10px;">  </div> <ul style="list-style-type: none"> Broaching Capacity of .050" thru 1.020" Eliminate Secondary Operations Use Standard Broaches <p style="font-size: small; text-align: center;">* Multiple Shank Sizes Available</p>	<p style="text-align: center; color: #c00;">SPECIAL ROTARY BROACHES</p> <div style="text-align: center; border: 1px solid gray; padding: 5px; margin-bottom: 10px;">  </div> <ul style="list-style-type: none"> INTERNAL AND EXTERNAL STANDARD M2 STEEL OR PM-4 OR T15 MATERIAL AN, CN AND TN COATINGS VENT HOLES SPUN GROUND DIAMETERS SPECIAL LENGTH & TOLERANCE
---	--

ORDER FACTORY DIRECT

586-465-5000

24 Hour Fax: 586-465-3030

www.SlaterTools.com

44725 TRINITY • CLINTON TOWNSHIP, MI 48038

Innovations in the design and
manufacture of aerospace
gears and gearboxes





AERO GEAR

CONNECTICUT USA

www.acrogear.com

(860)688-0888 info@acrogear.com

SPIRAL BEVEL GEARS (Transmissions)



Spiral & Straight Bevel Gear Manufacturing.
Commercial to aircraft quality gearing.
Spur, helical, splined shafts, internal & external,
shaved & ground gears. Spiral bevel grinding.
Midwest Transmissions & Reducers.
ISO compliant.



MIDWEST GEAR
& TOOL, INC.
15700 Common Rd.
Roseville, MI 48066

midwestgear@sbcglobal.net

CONTACT:
CRAIG D. ROSS
(586) 779-1300
FAX (586) 779-6790

NEWS

wide. Each company has unique products and business systems that help their customers remain globally competitive," says Marposs S.p.A. president Stefano Possati.

Control Gaging Incorporated produces quick set-up gages and process control systems for grinding machines and other machine tools. Marposs S.p.A. develops inspection and process control technologies for a broad range of manufacturers.

"Both companies are excited about the new opportunity this acquisition creates," says Edward Vella, president of U.S. operations for Marposs. "It will help us add even more value for our customers as we continue to support their machining process control needs."

Bodine Electric's Low-Voltage Products

COUNTER HIGH ENERGY COSTS

With rising energy costs and environmental concerns, Bodine Electric recently announced the release of a low-voltage product line. Bodine engineers have worked with OEMs to develop gearmotor, motor and control efficiency products like solar powered water circulators and power generating facilities.

These products can either run independently of the electrical grid or utilize solar power as an energy source. According to the company's press release, applications for these devices include medical devices, labeling equipment, printing presses, photocopiers, scientific/laboratory equipment and factory automation.

Bodine products are available through a distribution network or sold directly to OEMs. The company offers more than 1,000 standard products and thousands of custom-designed, fractional horsepower electric motors, gearmotors and motion controls.

Do your gears need:

**More strength?
Longer life?**

Shot peening is the answer. To learn more, subscribe to *The Shot Peener*. *The Shot Peener* is dedicated to raising the awareness and appreciation for the shot peening process.

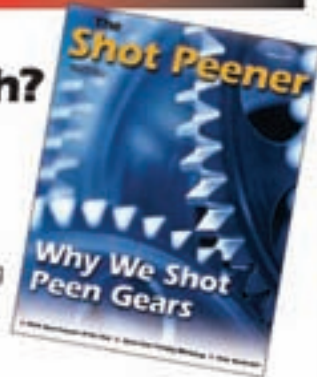

Magazine Subscription Request

I want a **free** subscription to *The Shot Peener*. Please send it to the address below.

Please print or attach your business card:

Name _____ Title _____

Company _____

Address _____

City _____ State _____ Zip _____ Country _____

Telephone _____ Fax _____

Email Address _____

Fax: (574) 256-5722

Mail: *The Shot Peener*

56790 Magnetic Drive, Mishawaka, Indiana 46545 USA

The Shot Peener: www.shotpeener.com

GT

SME

RELEASES LATEST VIDEO
IN MANUFACTURING
INSIGHTS SERIES

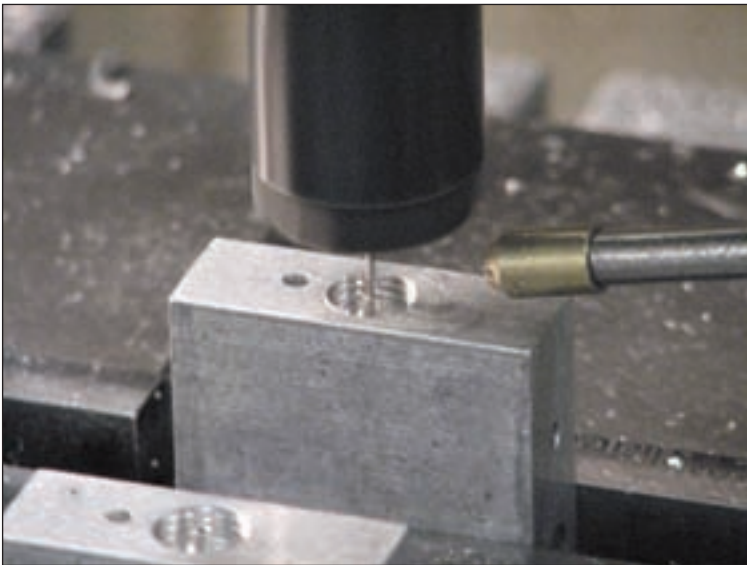

The Society of Manufacturing Engineers (SME) recently announced the release of *Minimum Quantity Lubrication*, an addition to the SME Manufacturing Insights Video Series. According to the organization's press release, the video surveys four different manufacturers that use MQL to apply only the minimum amount of lubricant needed for each job.

Companies involved in the survey include the Ford Motor Co., Amerimax, Advance Mold and World Machinery and Saws System Co. These companies previously relied on traditional flood-coolant methods that create high handling, cleaning and disposal costs.

"This video is well done and should be considered a 'must see' for engineers considering flood applications for new machine tool systems," says Gary Rodak, president of Machining Efficiencies, Inc.

The 40-minute video costs \$149 or \$129 for SME members. It can be ordered online at www.sme.org/store or by phone at (800) 733-4763.

Portable CNC gear pitch tester ES 4100



The portable pitch measuring instrument ES 4100 offers an extremely exact method of measurement. A high degree of operational convenience is possible by the built in processing of the measured data and the tilt and Swivel display touch-screen. ISO, DIN or AGMA standards evaluation software. The measurements can be stored and printed out on an external PC.

Donner + Pfister AG
Switzerland

Tel: +41554402032
info@dpag.ch
www.dpag.ch



GROUND GEARS – Ten or Ten Thousand

For small to medium quantities of spurs or helicals that have to meet close-tolerance AGMA or DIN specs, our Reishauer grinders and M&M gear analysis systems are the perfect combination.

For Long runs, we offer the unique Liebherr CBN grinding process with full SPC quality control and documentation.

So whether your needs are for ten or tens of thousands, we invite you to join the growing list of INSCO customers who rely on us for consistent quality, reasonable costs, and reliable delivery.



PHONE: 978-448-6368
FAX: 978-448-5155
WEB: inscocorp.com
412 Main Street, Groton, Massachusetts 01450

ISO 9001 Registered

Romax

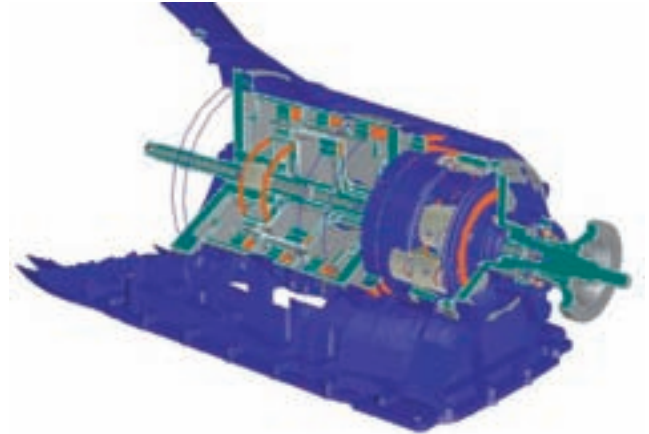
PROVIDES FORD
WITH ANALYSIS SOFTWARE

The NVH and bearing analysis software from Romax Technology, Inc. has been designated as the principal engineering tool for predictive analysis of automatic transmission gear whine at Ford Motor Company.

“The Romax analysis system software will provide Ford with a significant reduction of CAE (computer-aided-engineering) processing time,” says Dr. Takeshi Abe, Ford technical fellow, NVH (noise vibration harshness).

According to the company’s press release, the software has been integrated into Ford’s transmission design and development process after extensive correlation and validation work between Romax and Ford’s transmission NVH engineering team. The specific software for Ford offers integrated systems for NVH and bearing analysis through software tools, training and engineering services.

“The Romax tools allow us to transform the transmission NVH process from a test-based hardware iterative approach to a process focused on up-front design optimization. This new process not only provides cost savings by decreasing repetitive hardware testing, but most importantly, the software makes it possible to design quiet transmissions more accurately than ever before,” says Takeshi.

Mario Felice, technical leader, powertrain NVH CAE, at Ford, adds, “Designing a nominal gear train that meets customer targets is just not enough anymore. Based on the technical collaboration between Romax and Ford, statistical modules have been created that allow us to factor in the manufacturing variability and initial design tolerances as part of the upfront gear whine evaluation process. This provides invaluable insight into the robustness of the gear train design early in the development process.”



By now, MFN (Metal Finishing News) is probably the world’s only publication entirely focusing on peening, blasting, cleaning and vibratory finishing!

MFN has a circulation of over 5300 issues, is distributed in **64 countries** and published 6 times a year. Contact info@mfn.li for 2 **free** sample issues!

www.mfn.li

New: A subscription of MFN includes the magazine IST, which is published twice a year (September and March).

IST covers all aspects of surface technology such as liquid coating, powder coating, automotive finishing, electroplating, parts cleaning, paint removal, blasting, conveyor technology and measuring.



ADVERTISERS INDEX

Use this index to contact advertisers

ADVERTISER	PAGE	PHONE	E-MAIL	INTERNET
Aero Gear	73	(860) 688-0888	buygears@aerogear.com	www.aerogear.com
American Metal Treating Co.	78	(216) 431-4492		www.americanmetaltreating.com
American Wera	36	(734) 973-7800		www.american-wera.com
Arrow Gear Co.	38	(630) 969-7640		www.arrowgear.com
B&R Machine & Gear Corp.	IBC	(731) 456-2636, (800) 238-0651	inquiry@brgear.com	www.brgear.com
The Broach Masters/Universal Gear Co.	19	(530) 885-1939	info@broachmasters.com	www.broachmasters.com
Circle Gear & Machine Co.	78	(708) 652-1000		www.circlegear.com
Clifford-Jacobs Forging Co.	20	(217) 352-5172	sales@clifford-jacobs.com	www.clifford-jacobs.com
Cole Manufacturing Systems Inc.	79	(248) 601-8145	dsmith@colemfgsystems.com	www.colemfgsystems.com
Colonial Tool Group Inc.	15	(734) 946-2733	info@colonialtool.com	www.colonialtool.com
Comtorgage Corp.	23	(401) 765-0900	kgradolf@comtorgage.com	www.comtorgage.com
Donner + Pfister	72,75	(585) 586-5746	gearmet@frontiernet.net	www.dpag.ch
Dragon Cutting Tools	39	(440) 331-0038		www.dragon.co.kr, www.gallenco.com
Engineered Tools Corp.	8	(248) 619-1616	rdeneau@engineeredtools.com	www.engineeredtools.com
Forest City Gear Co.	40-41	(815) 623-2168	fyoun@fcgear.com	www.fcgear.com
Gear Consulting Group	79	(269) 623-4993	gearconsulting@aol.com	
Gear Manufacturing Inc.	78	(800) 773-GEAR		www.gearmanufacturing.com
Gear Motions Inc.	78	(315) 488-0100	sales@nixongear.com	www.gearmotions.com
The Gear Works—Seattle Inc.	78	(206) 762-3333	sales@thegearworks.com	www.thegearworks.com
Gleason Corp.	42	(585) 473-1000	dmelton@gleason.com	www.gleason.com
Haas Automation	13	(800) 331-6746		www.haascnc.com
Havlik Gear	59	(519) 624-6240	havlik@sympatico.ca	www.havlikgear.com
Höfler	OBC	(734) 416-9300	inquiries@greatlakesgeartech.com	www.greatlakesgeartech.com
Index Technologies	79	(440) 995-4627		www.gallenco.com
Inductoheat	69	(800) 624-6297		www.inductoheat.com
Ingersoll Cutting Tools	35	(815) 387-6600	ictc@ingersoll.com	www.ingersoll.com
Innovative Rack & Gear	78	(630) 766-2652	info@gearacks.com	www.gearacks.com
Inscocorp.	75	(978) 448-6368	sales@inscocorp.com	www.inscocorp.com
ITW Workholding	39	(800) 544-3823	sales@itworkholding.com	www.itworkholding.com
Kapp Technologies	3	(303) 447-1130	info@kapp-usa.com	www.kapp-usa.com
Machine Tool Builders Inc.	6	(815) 636-7502	kflowers@machinetoolbuilders.com	www.machinetoolbuilders.com
McInnes Rolled Rings	34	(800) 569-1420	sales@mcrings.com	www.mcinnesrolledrings.com
Metal Finishing News magazine	76	(212) 633-3100	metalfinishing@elsevier.com	www.metalfinishing.com
Micro Surface Corp.	79	(408) 723-0700	info@ws2coating.com	www.ws2coating.com
Midwest Gear & Tool Inc.	74	(586) 779-1300	midwestgear@sbcglobal.net	
Mitsubishi Gear Technology	10	(248) 669-6136	info@mitsubishigearcenter.com	www.mitsubishigearcenter.com
Nachi Machining Technology Co.	7	(586) 263-0100	sales@nachimtc.com	www.nachimtc.com
Nelson Engineering	78	(714) 893-7999	sales@nelson-eng.com	www.nelson-eng.com
Niagara Gear Co.	30	(716) 874-3131	info@niagaragear.com	www.niagaragear.com
Overton Gear	31	(630) 543-9570		www.overtongear.com
Precision Gage Co. Inc.	71	(630) 655-2121	sales@precisiongageco.com	www.precisiongageco.com
Presrite Corp.	29	(216) 441-5990		www.presrite.com
Proto Manufacturing	22	(519) 737-6330		www.protoxrd.com
The Purdy Corp.	33	(860) 649-0000	finance@purdytransmissions.com	www.purdytransmissions.com
Reishauer Corp.	79	(847) 888-3828	reishauer-us@reishauer.com	www.reishauer.com
Richardon GmbH	24	+(49) 7191-3665-0	info@richardon.de	www.richardon.de
Riverside Spline & Gear	28	(810) 765-8302	valerief@splineandgear.com	www.splineandgear.com
Schafer Gear Works Inc.	14	(574) 234-4116		www.schafergear.com
Schnyder S.A.	72	(630) 595-7333	hanikcorp@aol.com	www.hanikcorp.com
SETCO	71	(800) 543-0470	sales@setcousa.com	www.setcousa.com
The Shot Peener magazine	74	(800) 832-5653, (574) 256-5001		www.shotpeener.com
Sigma Pool	5	(734) 429-7225	info.lgt@liebherr.com	www.sigma-pool.com
Slater Tools	73	(586) 465-5000		
Solar Atmospheres	78	(800) 347-3236		www.solaratm.com
Star SU LLC	IFC, 1	(847) 649-1450	sales@star-su.com	www.star-su.com
Stock Drive Products/Sterling Instrument	21	(516) 328-3300		www.sdp-si.com/e-store
Stresstech	66	(724) 410-1030	info@astresstech.com	www.astresstech.com
Ticona	45	(800) 833-4882		
TSA America	17, 78	(440) 614-0170		www.tsageartools.com

GEAR MANUFACTURING

Quality Products That Meet Customer Specifications Delivered on Time...



CNC Gear Grinding



CNC Gear Analysis



CNC OD/ID Grinding

gmi GEAR MANUFACTURING INCORPORATED
www.gearmanufacturing.com

Complete Precision Gears Under One Roof...
Ph: 800-773-GEAR Fax: 714-792-2870

INNOVATIVE RACK & GEAR COMPANY



Custom Manufactured Various Rack Shapes, Sizes and Materials

- Unique Tooth Configurations • Heat Treating
- Complete Machining • Accuracy Tolerance up to AGMA Q12 • Spur, Helical, Relieved, Tapered, Crowned • Breakdown Service Available
- Reverse Engineering Capability

797 Eagle Drive • Bensenville, IL 60106
PH: 630-766-2652 • FAX: 630-766-3245
www.gearracks.com

HEAT TREATING



AMERICAN METAL TREATING

Induction Hardening Experts Specializing in Gears

Phone: 216.431.4492
Fax: 216.431.1508

Induction Hardening
Specialists in tooth by tooth contour hardening of internal spur, helical and bevel gears.

Our gear hardening equipment includes 5 NATCO submerged process machines and 5 AJAX CNC-controlled gear scanning machines. Tooth by tooth gear hardening from .5DP-10 DP, up to 15 tons, 200" diameter.

Breakdown Service Available
americanmetaltreating.com

WHEN IT HAS TO BE RIGHT

- Gear Grinding to 94"
- Industrial Gears to 250"
- Turbo Compressor Gears
- Custom Drives
- Spline Broaching
- Gear Metrology
- Stock Planetary Speed Reducers



GEARBOX REPAIR

Custom Gear Services Since 1946

ISO-9001
www.thegearworks.com

The Gear Works—Seattle, Inc.
500 S. Portland Street
Seattle, WA 98108-0886
Phone: (206) 762-3333
Fax: (206) 762-3704
E-mail: sales@thegearworks.com

Manufacturing ALL TYPES of custom gears

Spiral Bevels, Straight Bevels, Spurs, Helicals, Worm and Worm Gears, Herringbones, Racks, Splines, Internal Gears, Sprockets, Ratchets

Tooth Cutting, Grinding & Shaving services available.

Due to customer demands, we have expanded our Straight Bevel ability and added Spiral Bevels to our capabilities. Our capacities are constantly expanding, so please forward your specific requirements for a prompt, competitive quotation.

Please fax your inquiries to Dennis Garthus



Circle Gear and Machine
1501 South 55th Ct. • Cicero, IL 60804
Ph: 708-652-1000 • Fax: 708-652-1100
www.circlegear.com
Quality Custom Gearing Since 1951

VACUUM CARBURIZING



Solar Atmospheres offers single chamber vacuum carburizing and insitu gas pressure quenching for The Metal Processing Advantage.

- Minimal Part Distortion & No Intergranular Oxidation
- Clean, Bright Parts
- Case Harden Various Alloys
- Uniform Case Depths

SOLAR ATMOSPHERES

(800) 347-3236 • www.solaratm.com

YOUR DEPENDABLE SOURCE FOR

SUCCESSFUL PROGRAMS

- GEAR MANUFACTURING
- GEARBOXES / ACTUATORS
- PRECISION MACHINING
- COMPLETE MRO SERVICES

AS9100 CERTIFIED

P 714.893.7999
sales@nel-eng.com
Orange County, CA

NELSON ENGINEERING
www.nel-eng.com



Gear Grinding and Cutting Services

Gear Motions' two manufacturing locations are leading suppliers of custom cut and ground spur and helical gears. Made complete or to your blanks.

GEAR MOTIONS, INC.
An Employee Owned Company

Learn about one of the most modern fleets of Gear Grinders, including the Höfler 700 and Gleason Tag 400 at Oliver Gear. See the latest Reishauer and Kapp Gear Grinding technology, at ISO 9001-2000 registered Nixon Gear, as well as the latest in CNC Gear Hobbing and cellular manufacturing.

PH: (315) 488-0100
www.gearmotions.com

HELP WANTED

Territory Reps. Wanted

For U.S. & Canada

Knowledge of Gear Cutting Tools Required.

Contact:
Janice Thomas
j.thomas@tsageartools.com
for available territories.



The gear industry's smart option
TSA America LLC
30311 Clemens Road, Ste. 2 • Westlake, OH 44145
Tel: (440) 614-0170 • Fax: (440) 614-0173
www.tsageartools.com

SERVICE

GEAR BASICS

Finally! A Basic School for Non-Experts!

Do you have people who are new to GEARS?

Do your production people need to know more about GEARS?

Cole Manufacturing Systems, Inc offers a beginning gear training course designed to your exact needs.

- Terminology of Gears
- Gear Functions and Basic Formulae
- Manufacturing Methods Inspection Methods
- Interpretation of Inspection Data
- Applying Inspection to Correct Problems

The course can be on-site, in your plant or training facility or off-site at a nearby facility. We come to you!

(248) 601-8145 FAX (248) 601-0505
Email: dsmith@colemfgsystems.com www.colemfgsystems.com

DULL HOBS

Equal Serious Downtime (costs)
But We Can Help...



You need your tools back Fast eliminating downtime and tuned to meet or surpass original design specs and that's where we come in... period.
Shipping & re-coating services available.



PHONE: 440.895.4627 (HOBS) • FAX: 440.331.0516
31136 LORAIN ROAD - FAIRVIEW PARK, OH 44126
WWW.GALLENCO.COM

Tough Smoothy

TimeSaver Lapping Compounds

TimeSaver hard and soft metal lapping compounds for gears, guides, bearings, bushings, valves and more.



Guaranteed not to imbed. Will not continue to cut. Diminishes to polish and then to inert material. No cleaning between steps. Indefinite shelf life, no waste.

CONTACT US ABOUT YOUR APPLICATION
(408) 723-0700 • info@ws2coating.com
www.ws2coating.com



AGMA School for Gear Manufacturing

Conducted by Gear Consulting Group

UPCOMING CLASSES

Star SU
Hoffman Estates, IL • April 2 thru 4, 2008

Liebherr America
Saline, MI • June 4 thru 6, 2008

For further information on these and other classes contact:
gearconsulting@aol.com
Ph: (269) 623-4993
Gear Consulting Group
P.O. Box 647, Richland, MI 49083

www.gearconsultinggroup.com • www.agma.org

THE POWER OF INFORMATION

PTE

powertransmissionengineering®



- Features
- Buying Consortium: Advantage Buyers and Sellers
 - AGMA—The Gear Industry's Resource
 - Search for Intelligent Brakes

Technical

- Processing and Design of Plastic Gears
- How to Design a Servo Control System
- Bearings for High Temperatures

www.powertransmission.com

PTE—Power Transmission Engineering The latest technical and product information about power transmission components

GEAR TECHNOLOGY



- Gear Expo 2007
- Booth Listings & Map
 - Sneak Preview
 - Solutions Center

- Technical Articles
- Advances in Bevel Gear Blades
 - Plastic Tooth Bending
 - High-Speed Gears for Extreme Applications

Superior Grinding Wheels for Today's Technology



Large Inventory of Blanks
275-400mm OD
84-125mm widths

Pre-Profile "On or Off" flange for precise, fast service

Fast Delivery Orders in by noon ship next day

For Most Generating Grinding Machines



tel: (847) 888-3828
fax: (847) 888-0343
reishauer-us@reishauer.com
www.reishauer.com

Be On The Lookout for Our Next GEAR TECHNOLOGY Issue Mar-April FOCUS Gear Design Engineering Trends, Gear Software, Training

Gear Technology—The Gear Industry's Information Source Since 1984, Gear Technology has been the industry's leading technology and educational journal.

www.geartechnology.com/subscribe.htm

Subscribe today!

CUSTOM BEVEL GEAR MANUFACTURING

**Per Your Specifications and/or Sample
Providing Inverse Engineering to Make a Clone of Your Sample**

- **Spiral Bevel Gears: 66" PD**
- **Straight Bevel Gears: 80" PD**
- **Spurs Helicals Spline Shafts**
- **Gearbox Repair/Rebuilds**
- **In-House Steel Material Warehouse**
- **Full Heat Treating Services**
- **EDM Wire Burning**

BREAKDOWN SERVICES

B&R

Machine and Gear Corporation

4809 U.S. Highway 45 Sharon, TN 38255

Toll Free: (800) 238-0651 Ph: (731) 456-2636 Fax: (731) 456-3073

E-mail: inquiry@brgear.com Internet: www.brgear.com



Family owned and operated since 1974



Powerhouses.

Gear Hobbing Machines

HF 900 - 3000.



Historically known for their leadership and innovation in Gear Grinding Excellence – today Höfler is likewise a leader in large gear hobbing machines with their revolutionary, highly accurate and powerful torque motor table drives, high horsepower spindles, all cast iron construction and available on-board gear inspection. www.hofler.com

