

AMERICAN PEAUTER

A graphic consisting of a dense, blue, wireframe-like structure that fans out from a central point at the top, resembling a stylized peacock tail or a fan of feathers. The lines are thin and create a complex, geometric pattern.

MAAG
ZURICH

A graphic consisting of a dense, blue, wireframe-like structure that fans out from a central point at the top, resembling a stylized peacock tail or a fan of feathers. The lines are thin and create a complex, geometric pattern.

LORENZ
ETTLINGEN

KAPP

A graphic consisting of a dense, blue, wireframe-like structure that fans out from a central point at the top, resembling a stylized peacock tail or a fan of feathers. The lines are thin and create a complex, geometric pattern.

The most experienced service team in the business is growing to meet your needs.

A Matter of Quality

When you decide to purchase a Pfauter, Kaap, Maag or Lorenz machine, you're making a strong statement about quality. Second best isn't good enough, you insist on the finest gear machinery available. We share your commitment and believe you deserve the same quality when it comes to service. That's why American Pfauter's field service team is the gear industry's largest and most experienced. Now, we're making that team even better to meet your continually changing service needs.

A Matter of Response

First of all, we added five experienced field service engineers to increase the level of service we provide to all our customers. Next, we've expanded the electronics training our field service people receive to keep them current on the latest technology. We've also made it easier to

reach our key service people at 312-640-7501 to obtain prompt, accurate answers to parts and service related questions. Finally, we're expanding the use of our Service Scorecard to obtain valuable customer input that will lead to even greater service satisfaction.

A Matter of Pride

While your new machine is being installed, or the next time it needs service, take a few minutes to talk to our field service engineer... the man in the blue coat. You have something in common. The pride you feel for your machine is the same pride he puts into servicing it. He'll be glad to answer your questions and explain the tests and procedures he uses. After all, your satisfaction is the most accurate measure of his success... and ours. American Pfauter Ltd., 925 E. Estes Avenue, Elk Grove Village, IL 60007. Phone (312) 640-7500.

AMERICAN PFAUTER
Building American Productivity

CIRCLE A-1 ON READER REPLY CARD

member
 machine
tool builders
ASSOCIATION

Who Says Quality Has to Cost More? We Don't!



New Angle Gear produces precision, hard finished spiral bevel gearing, at cut and lapped prices.

Utilizing the Klingelnberg HPG-S method, state-of-the-art equipment delivers spiral bevel gears up to 30 inches diameter, at AGMA Levels 10-13. And New Angle gears accommodate higher loads (torque) with "whisper" quiet operation. Or . . . you may opt to reduce gear size to further reduce cost.

Also, matched sets are a thing of the past with our process of proven repeatability.

Our FREE quick facts brochure can tell you a lot more . . . Write or Call:



NEW ANGLE GEAR

King of Prussia, PA 19406

Phone: (215) 337-5400

Before you buy a CNC Gear Inspection System, ask these four questions



1. Can we get complete inspection of both gears and cutting tools?

With the M & M 2000 QC System, the answer is yes. The system will test lead and involute profile characteristics of internal or external gears and splines. It is the only universal gear tester available which provides true index testing without expensive attachments. In addition, we have fully-developed software for checking hobs, shaver cutters, shaper cutters, and other cylindrical parts such as worms and cams.



Hob Pressure Angle Check



Shaver Cutter Lead Check

2. Can you customize software to meet our quality-inspection specifications?

At M & M Precision, we write and develop our own inspection software. Our technical team can and has implemented inspection specifications into specific software for individual requirements. Our current library includes line/curve fitting as well as modified K-chart analysis routines.



Line/Curve Fitting

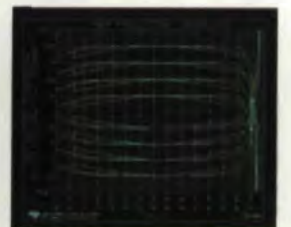

Modified K-Chart Analysis

3. OK, you can inspect gears and cutting tools. What else is available to aid us in quality control of the manufacturing process?

At M & M Precision, we have fully integrated such advanced software packages as Statistical Process Control and Tooth Topography into our standard testing software. Our SPC program can identify non-random variations and provide early warning of variations which are approaching tolerance limits. Our Tooth Topography software features automatic testing of lead and involute at multiple locations and provides two- and three-dimensional graphics.

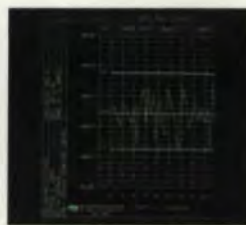

SPC Run Chart



Topological Map

4. Do you have the technical support team and installation experience to back up the hardware and software provided?

At M & M Precision, we have a technical team with over 45 man-years of experience in developing CNC gear inspection hardware and software. All software for our QC 2000 System has been developed in-house. In addition, we have working installations at these leading companies:

- General Motors
- TRW
- Ford Motor
- Warner Gear
- Cincinnati Milacron
- Chrysler
- Pratt & Whitney
- Rocketdyne

For details on our advanced QC 2000 System and available software, contact M & M Precision Systems, 300 Progress Road, West Carrollton, Ohio 45449, 513/859-8273.

M&M PRECISION SYSTEMS

AN ACME CLEVELAND COMPANY

CIRCLE A-6 ON READER REPLY CARD

EDITORIAL



As GEAR TECHNOLOGY moves toward its third anniversary, we feel that we have reached a point in our development where it is time to pause, reflect on our accomplishments and plan for the future.

Our first months were filled with everything necessary to get a new magazine started and published. Prototypes were designed, advertisers and authors were contacted, printers and typographers were interviewed and selected. We were simultaneously reading and editing articles, explaining to advertisers the benefits and necessity of this magazine and learning the publishing business. In May, 1984, our first issue was

published. The enthusiastic support of you, our readers, along with the favorable results for our advertisers have enabled GEAR TECHNOLOGY to secure a place in our small, but important industry. Our readership has grown and GEAR TECHNOLOGY now has paid subscribers in 41 foreign countries.

We then embarked on the next phase of our development. We developed relationships with most every technical society and research organization connected with the gear industry. We have received excellent support and cooperation from such organizations as the American Gear Manufacturer's Association, Society of Manufacturing Engineers, American Society of Mechanical Engineers, and ASME-Gear Research Institute. We also contacted American and foreign universities that are involved in gear research to bring you the latest developments in the industry.

Your enthusiastic response to our subscription campaign tells us that you have been satisfied with what we have been doing up until now. We are proud of how far we have come in three years, but we don't want to stand still, resting on past achievements. We want to publish the best possible magazine for our readers. To achieve this goal, we must call on you, our strongest supporters, to tell us how we can improve. Within this issue, you will find a reader survey which will give us some insight on how we can serve you better. Please take a few minutes to fill out this simple survey and return it today. No postage is necessary. Please let us know how we can serve you better.

Michael Goldstein

A handwritten signature in black ink that reads "Michael Goldstein". The signature is written in a cursive, flowing style. Below the signature, the words "Editor/Publisher" are printed in a smaller, sans-serif font.

Editor/Publisher

TECHNICAL CALENDAR

The American Society for Metals announces its North American Forging Technology Conference to be held on **March 31-April 1** in Cleveland, Ohio. Areas of discussion included in this event are:

- * Aerospace Forging Technology
- * Precision Forging of Steels
- * Materials/Tooling/Processes
- * Research/Development and Future Applications.

For further information contact:

Mr. Don Varnese
ASM International
Metals Park, Ohio 44073
(216) 338-5151

Call For Papers:

The Society of Manufacturing Engineers has issued a "Call for Papers" for the 1987 "Gear Processing and Manufacturing" clinic. The clinic is scheduled for November 17-19 in Detroit, Michigan.

Individuals who wish to be considered for a presentation should submit an abstract (100 words or less) of the paper to Joseph A. Franchini, Program Administrator, Special Programs Clinics Division, Society of Manufacturing Engineers, One SME Drive, P.O. Box 930, Dearborn, MI 48121. Abstracts must be received no later than June 19, 1987. For more details, contact Mr. Franchini at (313) 271-1500, ext. 394.

SME is offering the following workshops and clinics:

Cutting Tool Materials and Applications

March 3-5
Itasca, IL

Metalworking Coolants

March 17-19
Dearborn, MI

Broaching Technology

April 7-8
Indianapolis, IN

Advanced Machining

May 6-7
Dearborn, MI

If you or your organization has announcements of interest to the *Gear Industry*, please let us know. Our deadline for including such items in a particular issue is the tenth of the month, two months prior to publication.

For more information or to send copy,

contact:

Nancy Bartels, Assistant Editor
GEAR TECHNOLOGY
P.O. Box 1426
Elk Grove Village, IL 60007
(312) 437-6604



CNC GEAR HOBBER

WITH GENERAL NUMERIC 3MB/4B-6 AXIS CNC

NO PROBLEMS

- No gears to change
- No limit switches to set
- No mechanical cycles to adjust

JUST PRODUCTION

- 70% savings in set-up time
- Full range of canned cycles
- Pitch accuracies to AGMA 11

Full range of models up to 72" Dia. available.

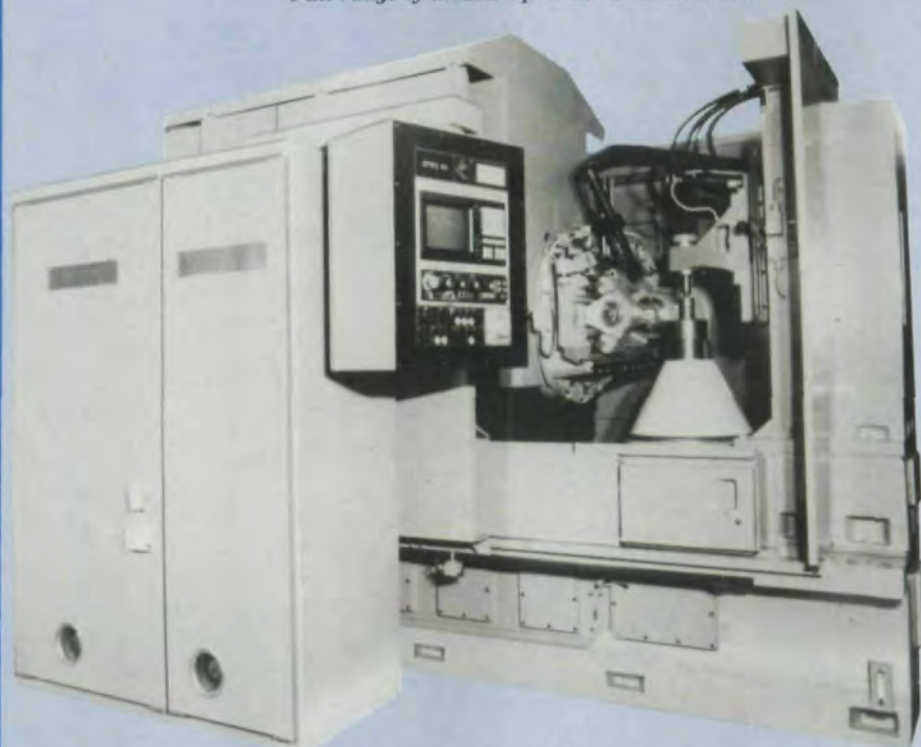

Model ZFWZ 05 CNC EZ 20.0" Dia. — 2.5 D.P.



WMW MACHINERY INC.

570 Bradley Hill Road • Blauvelt, New York 10913
Phone (914) 358-3330 - Gear Division, Chicago, IL (312) 364-4530

Gear Saver™

Why buy a machine to do a Gear Saver's™ job?



Abrasive Technology's Gear Saver™ is a patented diamond coated hard gear finishing system for correcting and modifying hardened gear teeth. Gear Saver™ corrects lead and profile errors, runout and oversize conditions as well as nicks and burrs from heat treat distortion and gear handling. Gear Saver™ salvages your gears without expensive grinding equipment, or highly specialized operators. Gear Saver™ is cost effective because it is an in-process operation for correcting your gears—right on your existing equipment—to restore the accuracy lost in the heat treating process. Abrasive Technology's Gear Saver™ easily corrects hardened gears requiring AGMA ratings of Class 9-10 and even higher. With diamond as the cutting edge, (the hardest material known to man) Gear Saver™ lasts longer, is more accurate and consistent than gear honing tools. Also, our hard gear finishing system is easy to use and capable of removing large amounts of material and in less time. For in-process corrections and salvage operations, Gear Saver™ is the answer. *After all, why scrap a perfectly good gear?* Call Abrasive Technology today for the representative in your area.



**abrasive
technology, inc.**

400 Green Meadows Drive N.
Westerville, Ohio 43081

614/548-4100

Mfg. in USA under Pat. Nos. 4077164, 4018576, 3894673

CIRCLE A-4 ON READER REPLY CARD

The Effect of Reverse Hobbing at a High Speed

Dr. Masato Ainoura
Dr. Kisaburo Nagano
Kurume National Technical College,
Kurume, Japan

Abstract

It is commonly believed that for helical gears, the hob thread must run in the same direction as the gears and that the best cutting method for such gears is the climb cut. But in the authors' opinion, conventional hobbing, using a hob with its helix running in the direction opposite the gear, is more effective for the high-speed manufacture of comparatively small module gears for automobiles. In this article the authors will prove experimentally and theoretically that reverse hobbing is very effective for improving both the life of hobs and cutting precision when performing high-speed, high-efficiency hobbing.

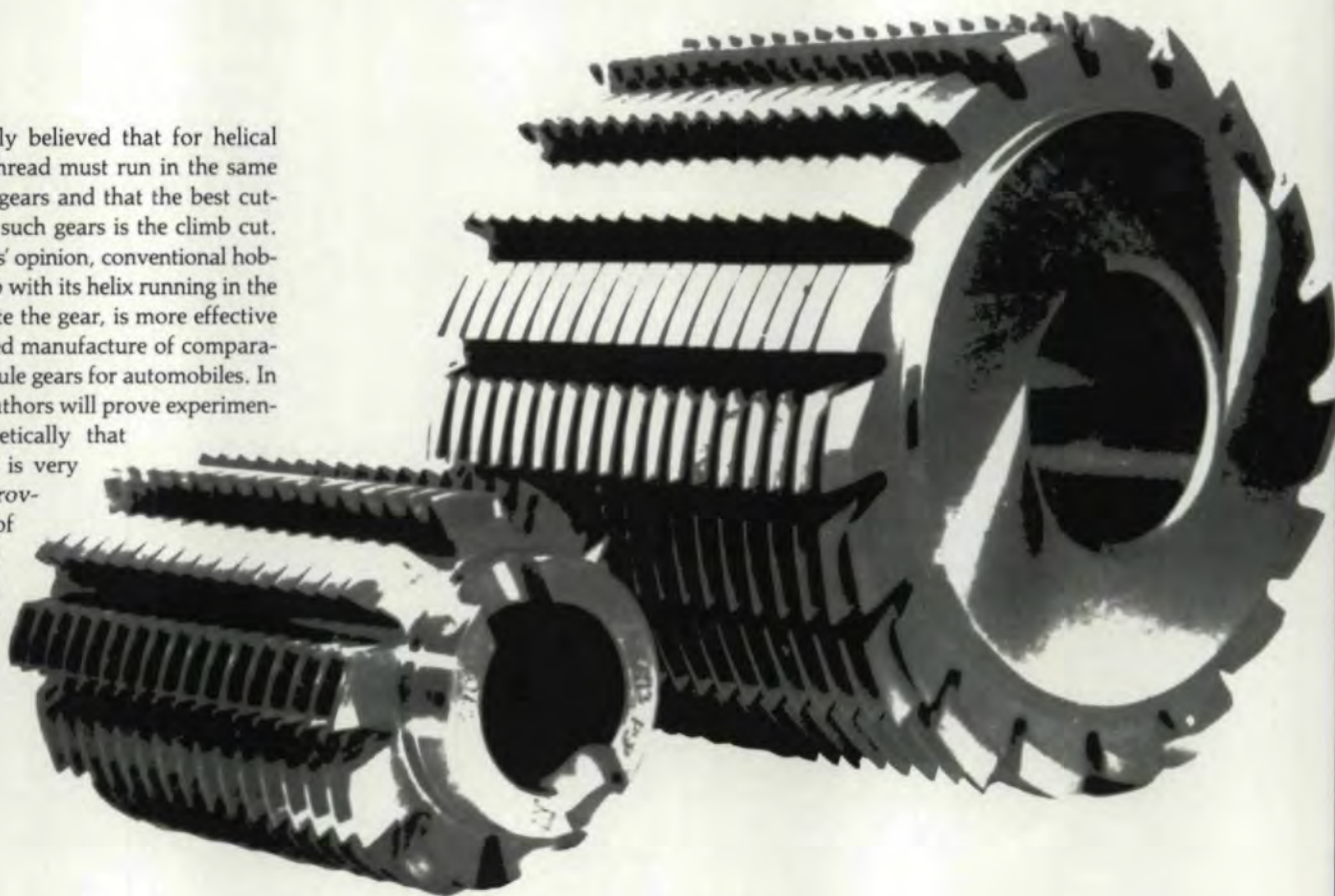

AUTHORS:

DR. KISABURO NAGANO is Associate Professor of Mechanical Engineering at Kurume National Technical College, Kurume, Japan. A graduate of Saga National University, Dr. Nagano is currently involved in research on high speed hobbing with HSS hobs and the cutting performance of TiN-coated HSS hobs.

DR. MASATO AINOURA is Professor of Mechanical Engineering at Kurume National Technical College, Kurume, Japan. He has been doing research in gear hobbing for nearly forty years. He is responsible for the development of carbide hobs and hobbers, carbide skiving hobs and shaving hobs and screw-shaped hones.

In 1966 he was awarded the Japan Society of Mechanical Engineering Paper Prize for research on hobbing and again in 1979 for research on the development of gear honing machines with screw-shaped hones.

Introduction

Today it is common practice when climb hobbing to keep the direction of the hob thread the same as that of the helical gear. The same generalization holds true for the mass production of gears for automobiles. It is the authors' opinion, however, that conventional hobbing with a reverse-handed hob is more effective for the high-speed manufacture of comparatively small module gears for automobiles. The authors have proven both experimentally and theoretically that reverse-handed conventional hobbing, using a multi-thread hob with a smaller diameter is very effective for lengthening the life of the hob and for increasing cutting efficiency at high speeds.

Cutting Function of Hob Teeth

Fig. 1(a) shows the same-handed climb hobbing commonly used for cutting helical gears. Fig. 1(b) shows reverse-handed hobbing using a hob set opposite to a helical gear. Cutting edges on the generating center are identified as Nos. 0, 1, 2, etc. in the direction of roughing.

Fig. 2 shows the profile of cutting chips theoretically calculated⁽¹⁾ and the function of each top cutting edge when the direction of the feed and the thread are varied. Black areas are chips numbered by every two cutting edges. Note that when reverse-handed, conventional hobbing is used, the entrance angle of every cutting edge is larger, and the thickness of the chips is reduced by half. (See

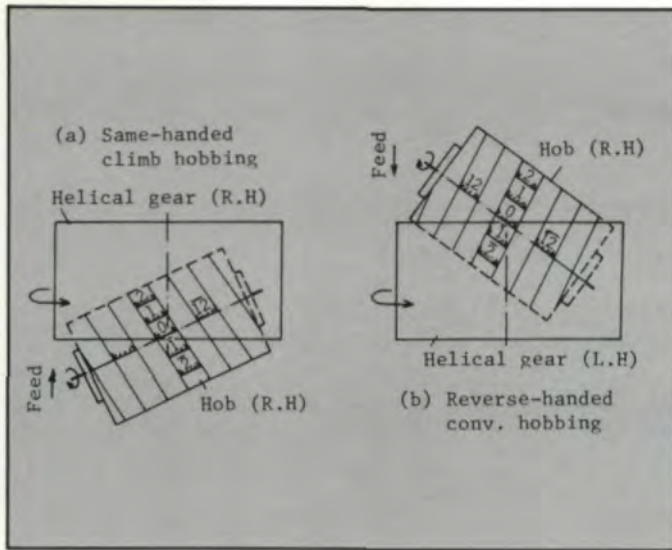

Fig. 1—Hobbing method of helical gear

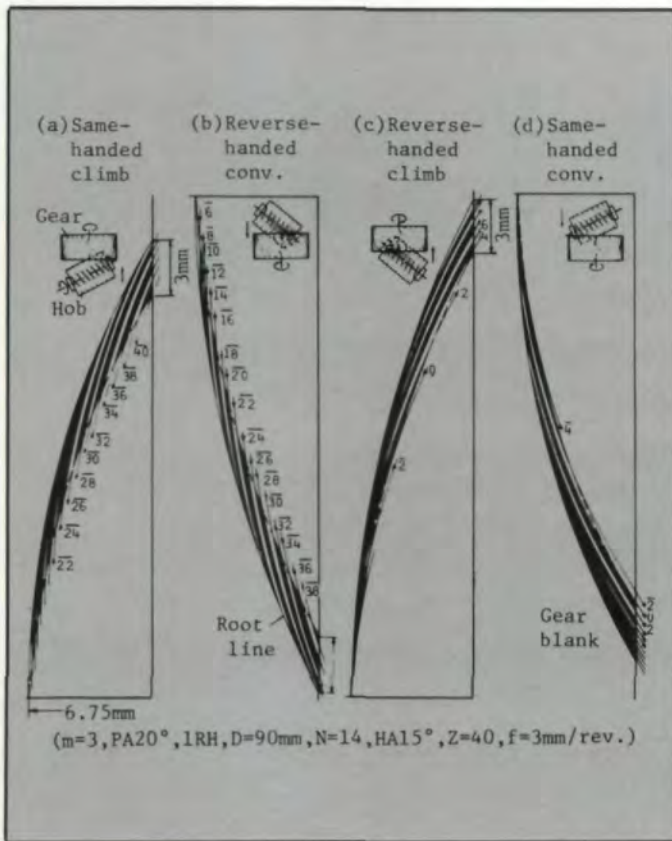

Fig. 2—Function of each top cutting edge

Fig. 3.) Moreover, a conventionally hobbled chip is long and thick. When the entrance angle is smaller, wear is increased, and the cutting edge is easily chipped because the cutting edge barely cuts in and tends to slip. When a chip is thick and short, the deepest crater wear is distant from the cutting edge. Then the edge is hardly broken because the temperature rises more slowly⁽²⁾ and,

naturally, extraordinary wear at the corner of the cutting edge is very limited.⁽³⁾ In other words, the life of the hob is greatly extended.

Damage to a Cutting Tooth

Fig. 4 shows the maximum relief wear after hobbing gears of SCM 415 case-carburizing steel for automobiles, using a cutting speed of 120m/min. and a feed

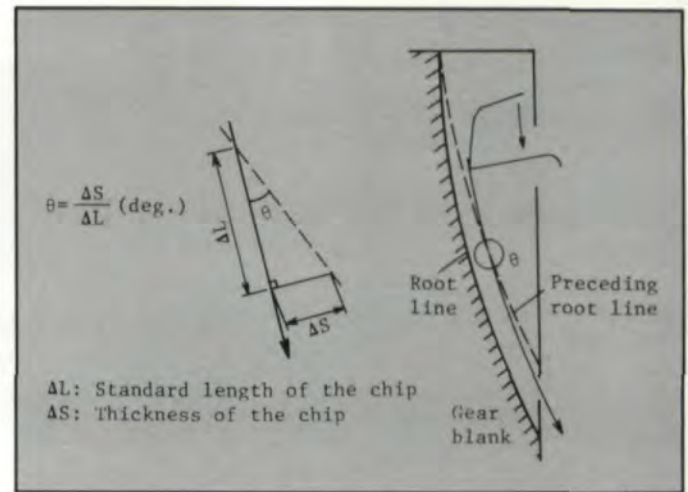

Fig. 3—Entrance Angle θ of the cutting edge

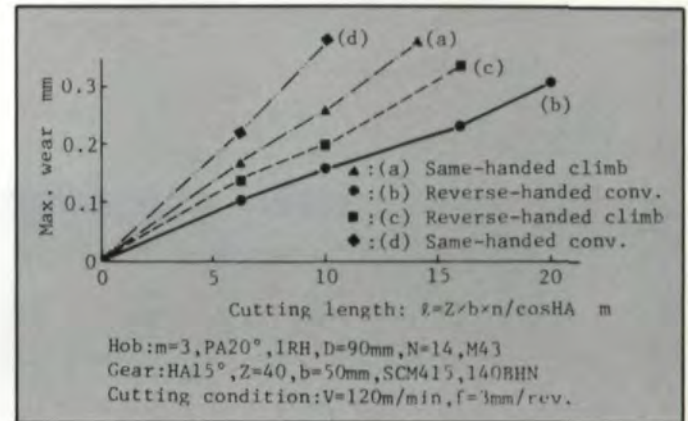

Fig. 4—The progress of the maximum relief wear (in case of a single-thread non-coated hob)

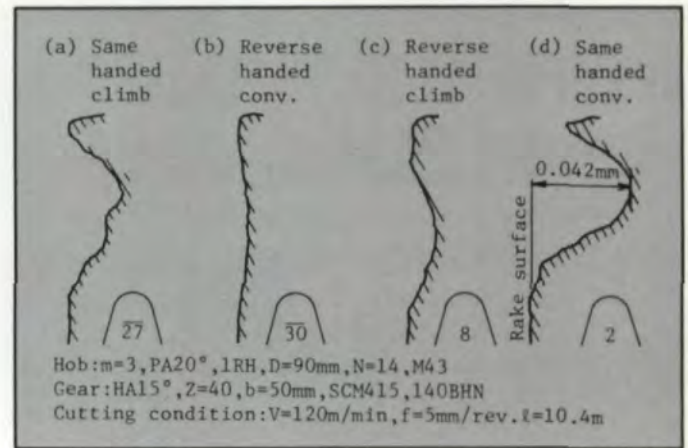

Fig. 5—Comparison of the crater wear

of 3 mm/rev. without a hob shift. As shown in the table, the life of a hob is the longest when reverse-handed conventional hobbing has been used.

Fig. 5 shows the crater wear after five gears (cutting length $l=10m$) were cut. The amount of crater wear is least in the case of reverse-handed conventional hobbing because the temperature of a cutting edge rises more slowly when this

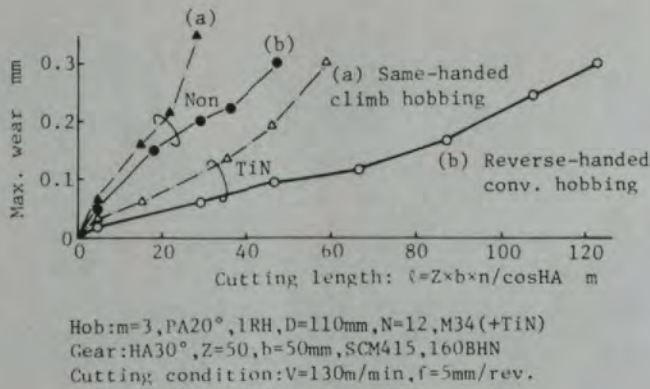

Fig. 6—The progress of the maximum relief wear (in the case of a single-thread TiN-coated hob)

method is used and extraordinary wear does not occur. From these figures, it can be seen that reverse-handed conventional hobbing is the most suitable method for use at high speeds.

Fig. 6 shows a comparison of the maximum relief wear after same-handed climb hobbing and after reverse-handed conventional hobbing at a cutting speed of 130m/min. and a feed of 5mm/rev., using a TiN-coated hob. (PVD method.) The life of a TiN-coated hob is greatly lengthened by the use of the reverse-handed conventional method because crater wear is so much less.

Fig. 7 shows the damage to each hob after gears with a cutting length, $l=12m$

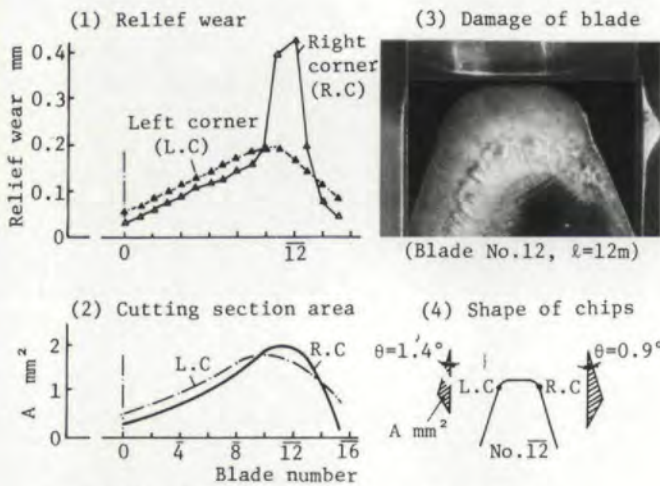

Fig. 7-(a) The same-handed climb hobbing

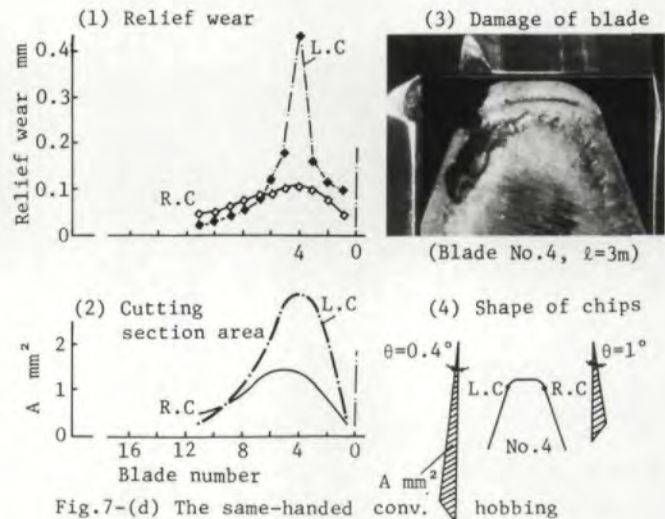

Fig. 7-(d) The same-handed conv. hobbing

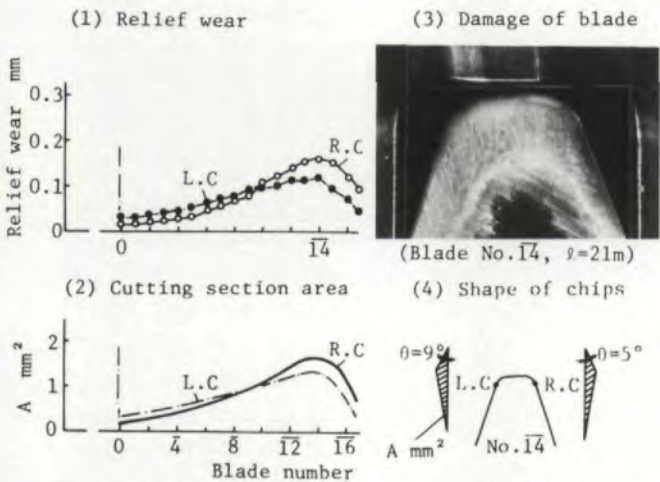

Fig. 7-(b) The reverse-handed conventional hobbing

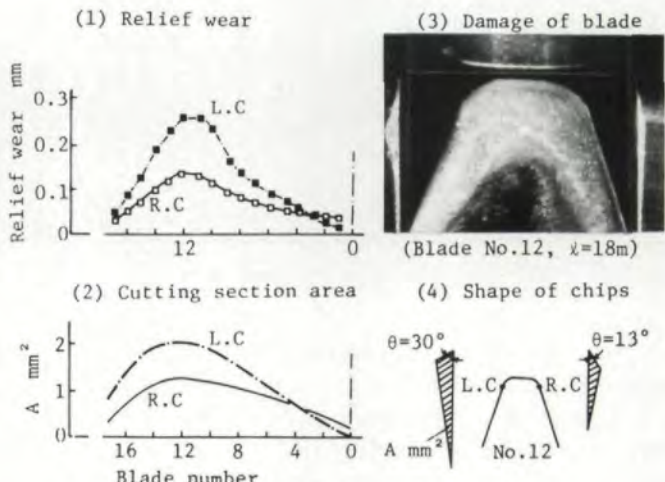

Fig. 7-(c) The reverse-handed climb hobbing

Hob: $m=3, PA20^\circ, 3RH, D=110mm, N=12, M34, \text{Non-coated}$ Gear: $HA30^\circ, Z=57, b=60mm, SCM415 (\text{AISI } 4118), 140BHN$
 Cutting condition: $V=130m/min, f=5mm/rev.,$ Hobbing machine: KS-14 Cutting oil: Daphne cut HS-4M

Fig. 7—The relief wear and shape of chips in various hobbing methods (in the case of a triple-thread hob)

had been cut at a speed of 130m/min. and a feed of 5mm/rev. using a triple-thread hob. Fig. 7(a) shows the damage to a hob after the same-handed climb hobbing method was used. The graph and photo at the top of the figure show the maximum relief wear on each right and left corner. The figures below show the cutting load⁽⁴⁾ theoretically calculated at the right and left corners, and the shape of the chips that come out from the right and left corners.⁽⁵⁾

Fig. 7(b) shows the amount of relief wear after reverse-handed conventional hobbing. The entrance angle of the cutting chips at the right and left corners (See Fig. 4.) is larger in comparison to Fig. 7(a). As cutting speed increases, the amount of wear decreases. The cutting load to each blade also decreases as the number of cutting blades increases.

Fig. 7(c) shows the results of reverse-handed climb hobbing, and Fig. 7(d) shows the results of same-handed conventional hobbing. As the figures show, there is a great difference between the cutting load of the right and left corners, and the amount of damage is greater than Fig. 7(b).

Fig. 8 shows the comparison of the maximum relief wear after hobbing at a high speed and feed with a triple-threaded hob. The amount of damage is influenced by the cutting method, and it is more evident when triple-threaded hobs are used.

From these figures, it can be seen that the reverse-handed conventional hobbing method with a multi-threaded hob at a high speed and feed is indispensable for improving cutting efficiency.

Answer to Higher Efficiency

Influence of a large feed. When using a multi-threaded hob, it is important to perform at high speed and with a large feed to increase cutting efficiency. Fig. 9 shows 2-, 3-, 4-, and 5-thread hobs for this experiment. All hob dimensions are the same.

Fig. 10 shows the maximum relief wear after same-handed conventional hobbing and reverse-handed conventional hobbing at various amount of feed with a double-threaded hob. In the case of same-handed climb hobbing, the hob life can be lengthened when the amount of feed is less. In the case of reverse-handed conventional hobbing, the hob life can

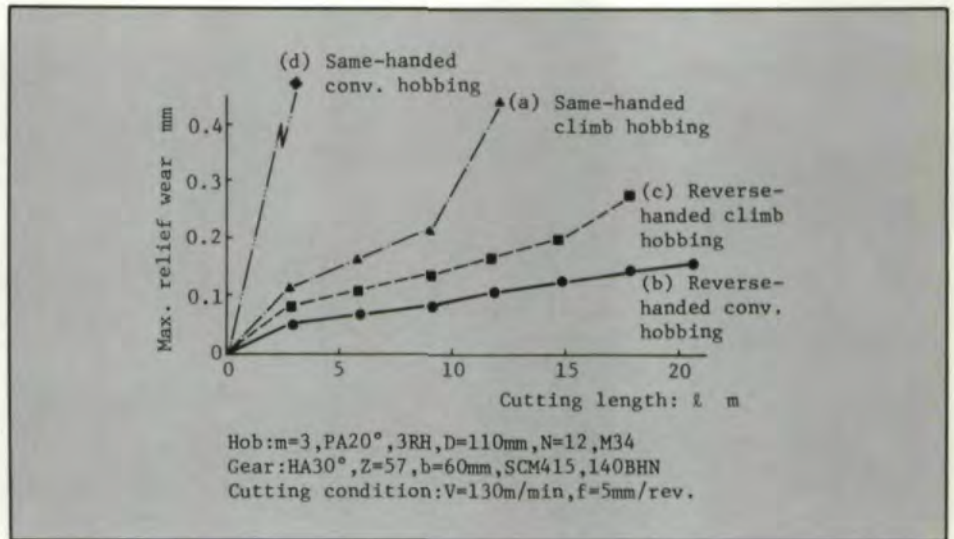

Fig. 8—The progress of the maximum relief wear (in case of a triple-thread non-coated hob)



Fig. 9—Multi-thread hobs with small diameter

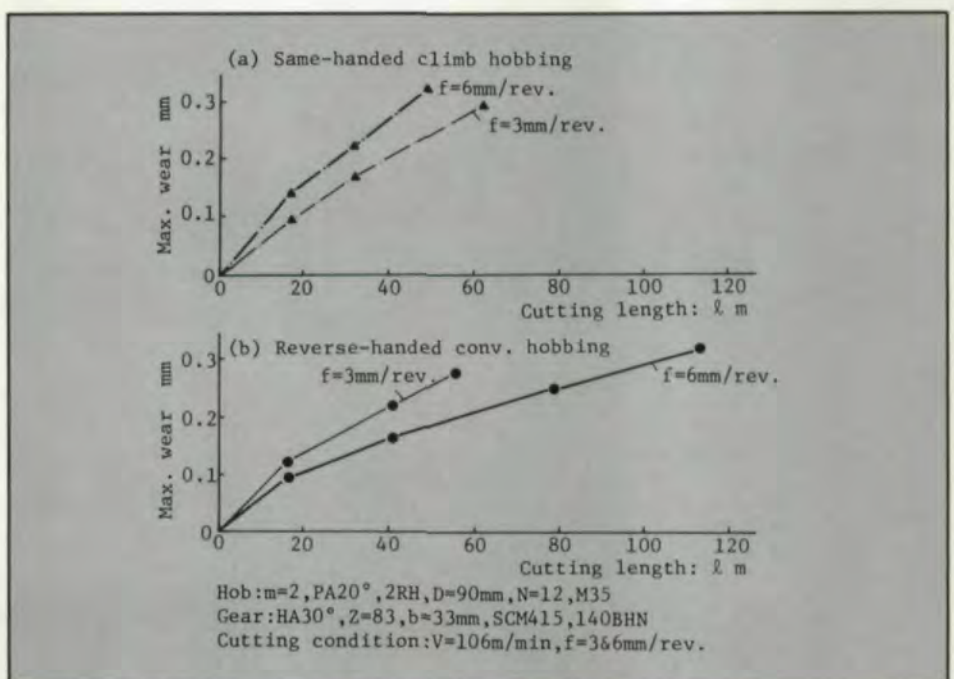

Fig. 10—Influence of hob feed (in the case of a 2-thread hob)

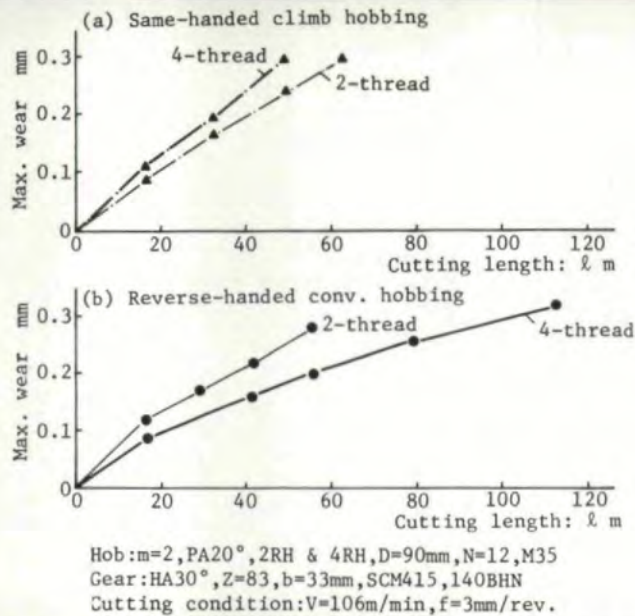

Fig. 11 - Influence of hob thread

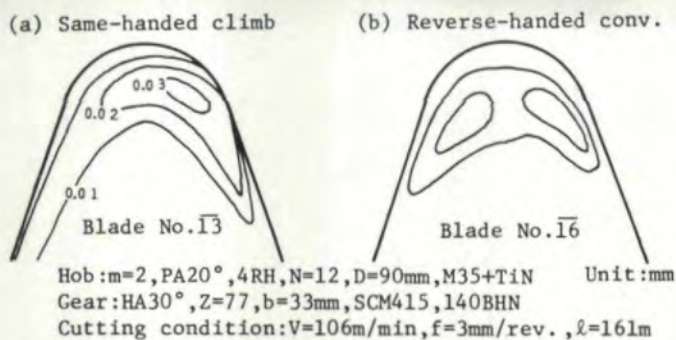

Fig. 12 - Comparison of the crater wear

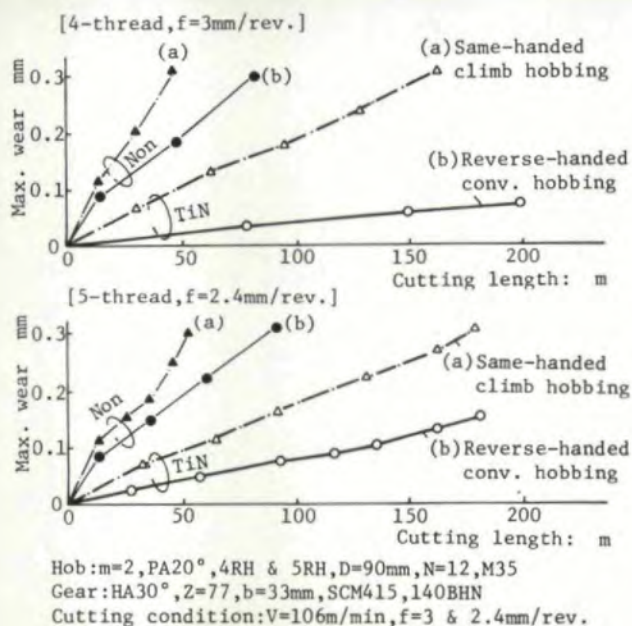

Fig. 13 - The progress of the maximum relief wear (in the case of a multiple-thread TiN-coated hob)

be lengthened when the amount of feed is greater. Therefore, reverse-handed conventional hobbing is suitable for increasing hobbing efficiency.

A multi-threaded hob. Fig. 11 compares the maximum relief wear after same-handed climb hobbing and reverse-handed conventional hobbing under the same cutting conditions when the number of threads varies. Fig. 12 shows the crater wear (contour line) of a four-thread hob.

Under the same cutting conditions, the hob life is shortened in same-handed climb hobbing as the number of hob threads increases. The life of the hob is dramatically increased when reverse-handed conventional hobbing is used and the number of hob threads increased.

Fig. 13 shows the effect of the reverse-handed conventional hobbing with 4-thread and 5-thread hobs that are TiN-coated. The life of a multi-threaded and TiN-coated hob is greatly increased and the amount of wear greatly decreased when reverse-handed conventional hobbing is used.

Smaller diameter hobs. Fig. 14 shows the life of a larger diameter/multi-threaded hob and a smaller diameter/multi-threaded/TiN-coated hob used for cutting differential drive ring gears in automobiles. If we suppose that a hob is resharpened when the maximum relief wear is 0.3mm, the cutting length becomes about 500m (175 pcs.) without hob shifting. Many gears can be produced before resharpening because a hob can be shifted.

Hobbing of Helical & Profile Shifted Gears

Recently mass-produced gears have been profile-shifted. In the case of high speed hobbing of profile shifted gears, addendum modification has greatly influenced hob wear in same-handed climb hobbing. Fig. 15 shows the progress of hob wear after profile-shifted gears with various addendum modifications were cut at high speed. The tooth profiles for both reverse-and same-handed conventional cutting are shown. In the case of reverse-handed conventional hobbing, addendum modification has little influence on hob wear; therefore, the reverse-handed conventional hobbing method is suitable for profile-shifted gears.

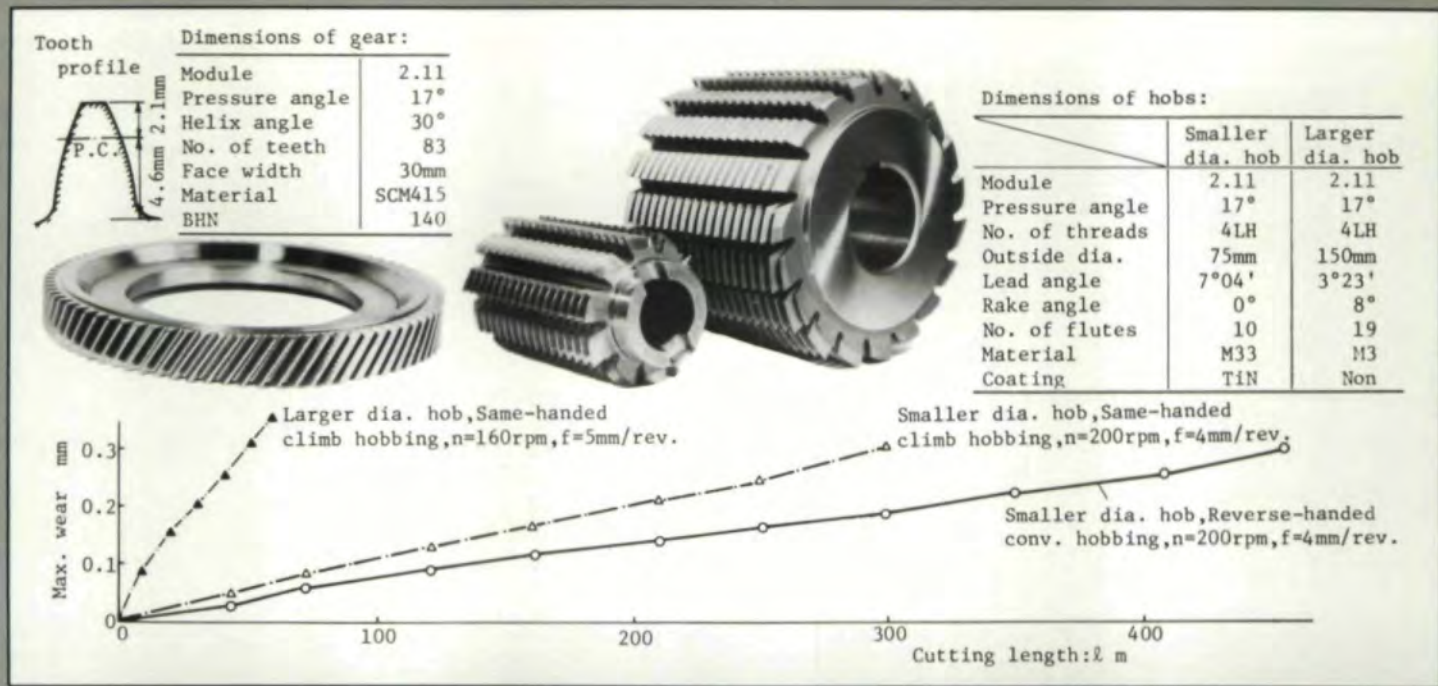

Fig. 14—The life of hobs for differential drive ring gears

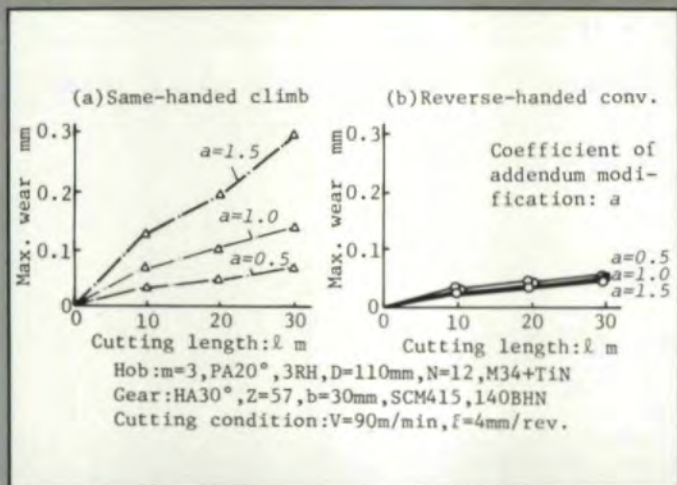

Fig. 15—The maximum wear of the profile-shifted gears

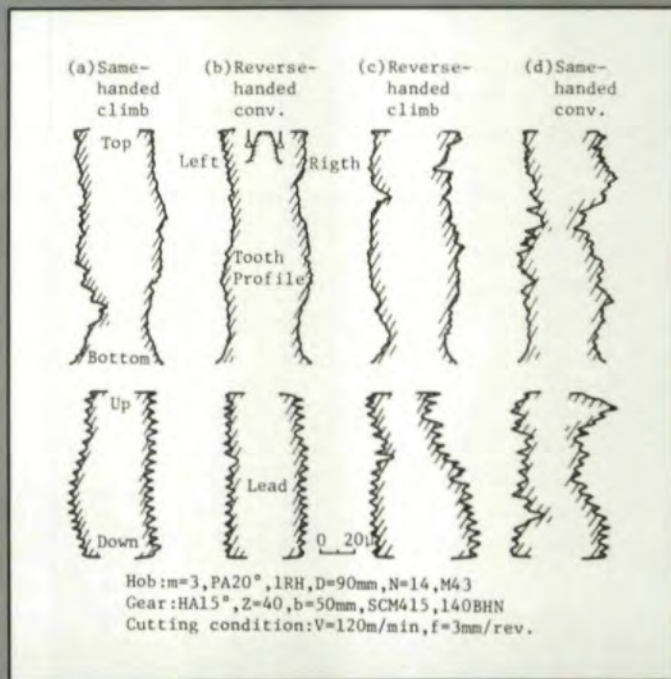

Fig. 16—Cutting precision of helical gears (in the case of single-thread hob)

Cutting Precision

Fig. 16 shows the tooth profile errors and lead errors of helical gears cut by a single-thread hob. The cutting conditions are the same as in Fig. 4. The cutting precision of the reverse-handed, conventionally hobbled gears is better than that of the same-handed, climb hobbled ones.

Fig. 17 shows the lead error of helical gears with 5 and 10 degree helix angles, when both same-handed climb hobbing and reverse-handed conventional hobbing have been used. (In both cases, the gears are made of case-carburized steel SCM 415/HB160 for automobiles.)

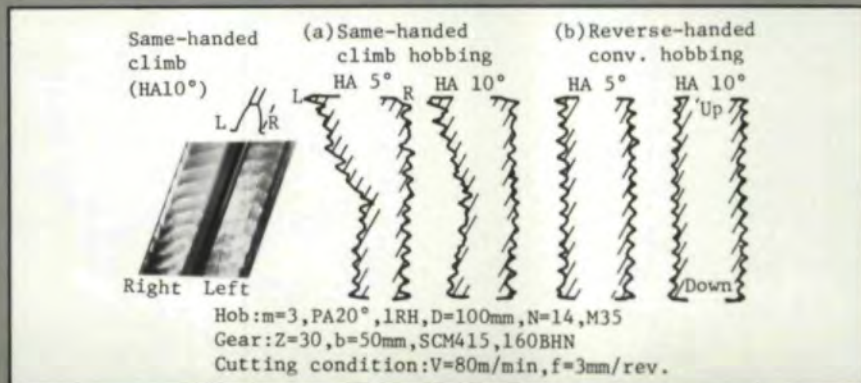

Fig. 17—The lead error of helical gear. 5° & 10°

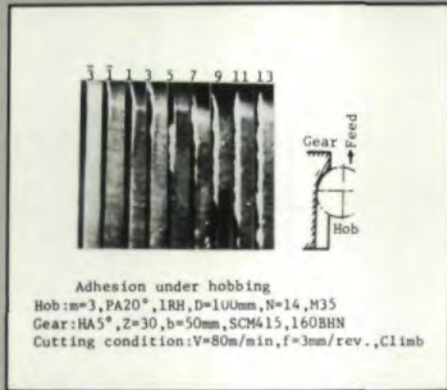

Fig. 18—The adhesion of each cutting edge

Fig. 18 shows the adhesion of each cutting edge in the gear with a helix angle of 5 degrees. This adhesion on each cutting edge makes the lead error and the tooth profile error worse in the case of the same-handed climb hobbled gear. On the other hand, little adhesion comes out in the case of the reverse-handed, conventionally hobbled gear or one with a large helix angle.

Fig. 19 shows the lead error of a helical gear cut by a 30 degree reverse-handed conventional hob with multi-threads and small diameter and TiN coating. When the number of hob threads and the gear helix angle increases, the hob setting angle becomes larger, and the component of the cutting force occurs in the direction of the table rotation of the hobbing machine. (See Fig. 20.) While the top of the hob blade is working, the cutting force is strong enough to accelerate the table, and while it is not working, the cutting force is not strong enough.

Naturally, lead error comes out at the end of hobbing. Therefore, it is necessary to eliminate the torsion, backlash and relative displacement of transmission system from a hob to a table and to eliminate the backlash of master worm gears.

Fig. 19—Lead error after reverse-handed conventional hobbing with multi-thread hob

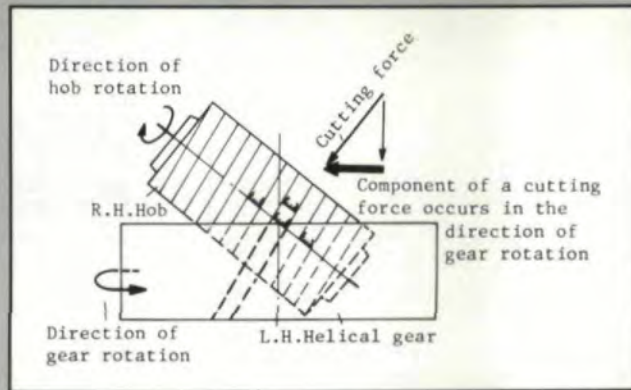
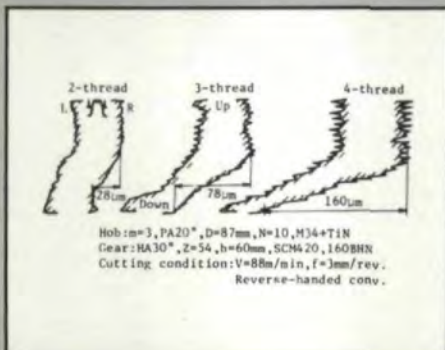

Fig. 20—Component of a cutting force and the direction of gear rotation

Fig. 21—Influence of hob feed after the reverse-handed conventional hobbing with triple-thread hob

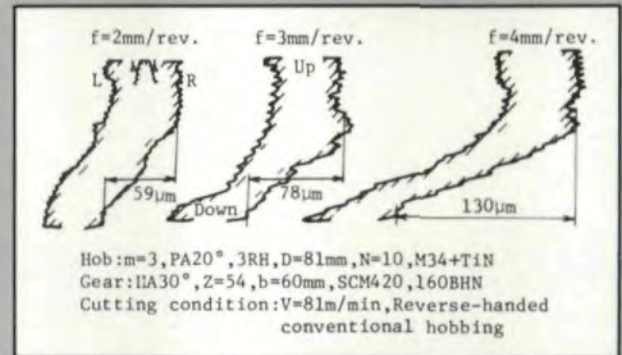

Fig. 22—Influence of hobbing machine

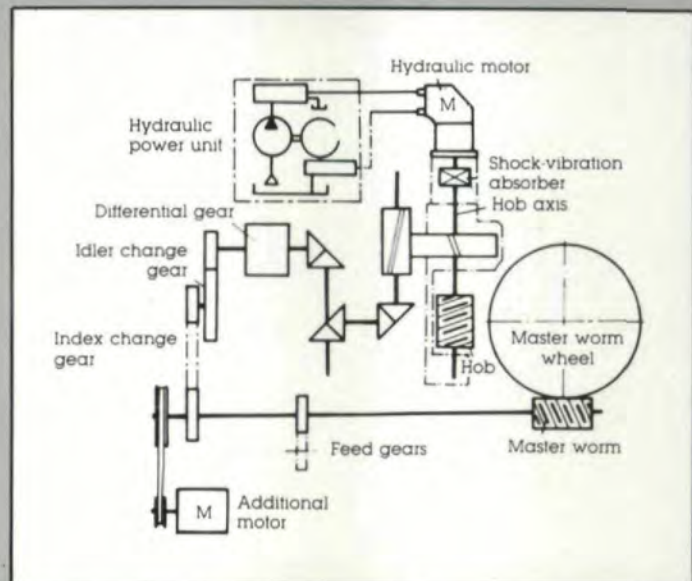
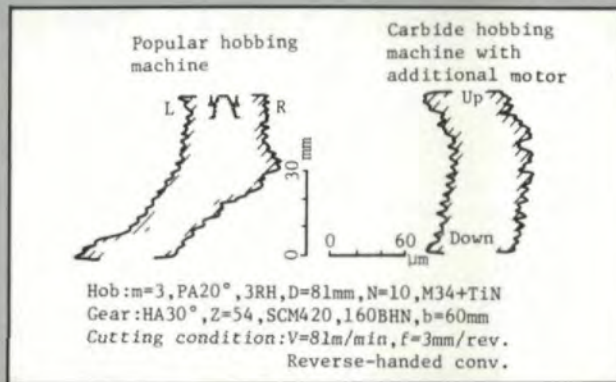

Fig. 23—Carbide hobbing machine with additional motor

Fig. 21 shows the lead error of gears reverse-handed and conventionally hobbled with a triple-threaded hob using an ordinary hobbing machine. The lead error becomes larger as the cutting force of the hob increases.

Fig. 22 shows the comparison of lead errors occurring when a gear is reverse-handed and conventionally hobbled on a ordinary hobbing machine with those taking place when a gear is hobbled with additional rotation to the master worm axis to eliminate the torsion, backlash and relative displacement of a table driving system on a direct-drive hobbing machine, as shown in Fig. 23.⁽⁶⁾ Figs. 24 and 25 show the improvements of lead error on an ordinary hobbing machine.

As a countermeasure, it is important to prepare the direct drive hobbing machine with high rigidity when helical gears with a large helix angle are reverse-handed and conventionally hobbled at high speeds and feeds, using a multi-thread hob.

Conclusion

The authors have proven both experimentally and theoretically that the reverse-handed conventional hobbing is more effective than same-handed climb hobbing when cutting comparatively small module mass-production gears at high speed and efficiency. But it is also important to reduce the torsion, backlash, and relative displacement of the driving system for generating motion, such as master worm gears, on a direct-drive hobbing machine. It is further recommended that reverse-handed hob-

(continued on page 46)

Fig. 24—Improvement of lead error on an ordinary hobbing machine

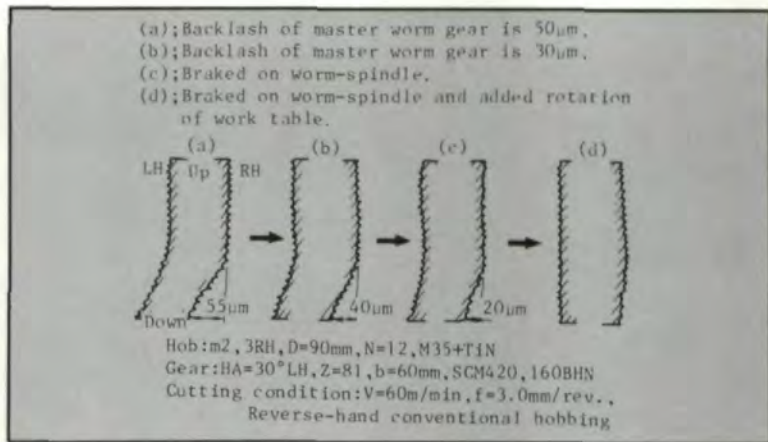
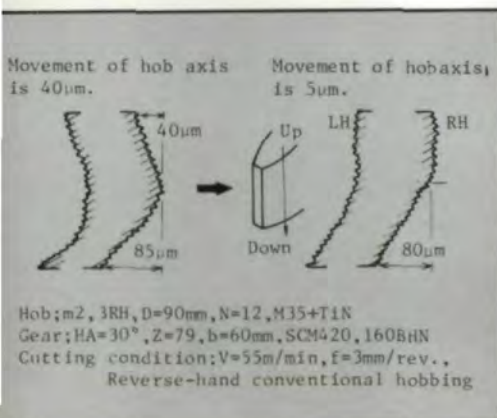

Fig. 25—Improvement of lead error on an ordinary hobbing machine

Where can you get precision gear cutting like this?

Forest City Gear features the most modern gear cutting facility available to you in the world. We specialize in hobbing and shaping ultra precision gears in low, medium and high volume. We also offer crown hobbing on the latest auto-loading hobbing machines.

The next time you need precision gears, come to The Source.
 Forest City Gear, 11715 Main St., P.O. Box 80, Roscoe, IL 61073.
 (815) 623-2168

FOREST CITY GEAR

The Precision Gear Source

CIRCLE A-15 ON READER REPLY CARD

Crowning: A Cheap Fix for Noise Reduction and Misalignment Problems and Applications

Frederick Young
Forest City Gear, Roscoe, Illinois

Noisy gear trains have been a common problem for gear designers for a long time. With the demands for smaller gear boxes transmitting more power at higher rpms and incumbent demands for greater efficiency, gear engineers are always searching for new ways to reduce vibration and limit noise without increasing costs.

Some popular solutions to the noisy gear problem are enlarging the pinion to reduce undercut, using phenolic, delrin or other noise absorbing products where possible, or changing to a helical gear train. Other methods include tightening specifications to insure greater gear quality or redesigning the acoustical absorption characteristics of the gear box. Occasionally, experimentation with gear ratios can limit harmonic frequency amplification, which otherwise can cause a gear box to amplify noise like a finely tuned stereo system. The engineer can also study material and hardness requirements so that modifications may be made to minimize heat treatment distortion or possibly eliminate the need for heat treatment entirely. Particular attention must also be paid to gear geometry to insure maximum contact.⁽¹⁾

Another approach to the gear noise problem which yields good results is crowning or barreling of the teeth. This technique involves changing the chordal thickness of the tooth along its axis. This modification

eliminates end bearing by offering a contact bearing in the center of the gear.

A second benefit of the crowning approach to gear cutting is the minimization of misalignment problems caused by inaccurate machining of the casting, housing, shafting, gear boxes or bearing journals. Crowning can also reduce lead problems in the gears themselves which cause the gears to wear unevenly and bind because of eccentricities and position errors. Obviously, the gear with a center contact is less affected by discrepant manufacturing or design; furthermore, one can reduce the backlash requirements and allow the gears to wear in rather than wear out.

Shaving is a secondary gear finishing operation done after rough hobbing or shaping to create the desired crown. Crown shaving has long been a popular method, especially in manufacturing coarse pitch gears. With the recent evolution of gear equipment capable of crowning while cutting, the need for shaving just to achieve a crown is eliminated.

Two variations of the crown shaving method will produce a gear to compensate for off-lead or misalignment conditions. One approach produces a crown by rocking the table during the reciprocation of work and cutter. The degree of crown is readily changed by this method. The other approach is plunge feeding, which requires dressing the shaving cutter to the desired crown. Generally, it is faster to plunge feed, but the technique can subject the cutter to greater wear. Of course, it is more difficult to change the crown.

Provided one starts with good quality gears, shaving improves the quality of profile and reduces error in the gear tooth through the cutting and burnishing action of the cutters.

The crown form can be produced on gear teeth in several other ways. One method is to shape the gear

AUTHOR:

MR. FREDERICK YOUNG is the owner and CEO of Forest City Gear Co. in Roscoe, Illinois. He has worked for the company since the mid-1950s and assumed its management in 1968. He is a graduate of Rockford College, where he studied physics, mathematics and English literature.

by use of a crown cam in the shaper back off mechanism. The proper radius of the gear is calculated by using the amount of crown on the flank and the pressure angle of the gear. Unfortunately, the blocks, while not complex, tend to be expensive.

The advent of the latest generation of gear equipment has made two methods of crowning while hobbing popular. Both methods produce crowns by increasing and decreasing the center distance of cutter to work. The first method utilizes physical copying of a template by a hydrocopying or mechanical following device. This allows taper hobbing or even the creation of sinusoidal wave forms if desired. More recently, the second method, CNC hobbing, has come into vogue. Depending on software limitations, CNC allows cutting gears in almost any desired form. A disadvantage to this approach is the high cost of the equipment.

Who is using this gear cutting technology today? Users of heavily loaded gears have been using crowning for quite some time. Another area ripe for the use of crowning is in the manufacturer of hydraulic wobble motors. Here, the application is strictly for misalignment problems rather than for noise reduction. An allied area involves heavily loaded pinions used in actuators for aircraft control surfaces. Generally speaking, it is more advantageous to crown the pinion because it makes more revolutions per minute and may generate more noise. In this case, it is of paramount importance to compensate for load deflection.

Unfortunately, few people in the United States have been applying this technology to commercial fine pitch gearing. However, the few manufacturers who have tried it are most pleased with the results. Some users have reported a five-to-tenfold reduction in noise, accompanied by less vibration, wear and power draw. Prime candidates for use of the crowning technique are the small fractional horsepower motor manufacturers or anyone dealing with spur or helical pinions susceptible to noise or misalignment. Because crowning on foreign gear hobbing equipment has been available for a greater length of time, the method has been developed to a greater extent in Europe. American manufacturers would be wise to take advantage of the availability of this kind of technology. Exploration of crowning as a solution to noise and misalignment problems can produce a real competitive advantage for gear manufacturers and users.

References

1. GITCHEL, KEN R., "Putting More 'Teeth' in Your Gear Design", *Machine Design*, Oct. 9, 1986.

BEVEL GEAR MACHINERY SERVICE

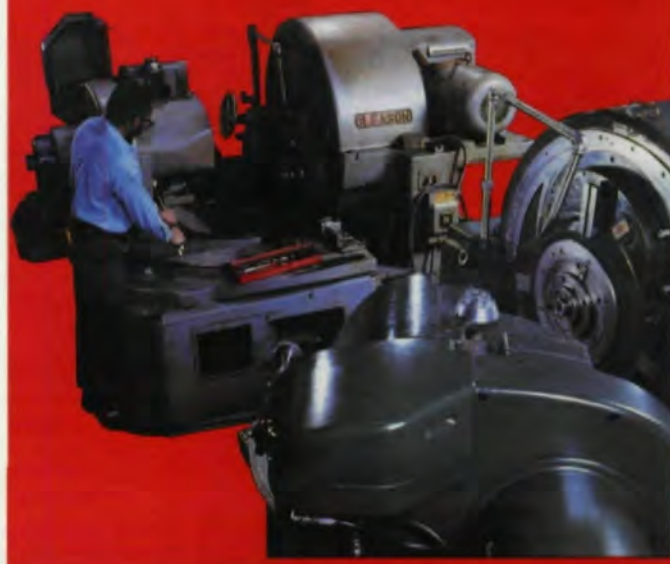

Complete, nationwide services exclusively for spiral, straight and hypoid generators, testers and grinders.

- No cost equipment evaluations
- On-site maintenance and repair
- Complete machine rebuild to factory specifications
- Guarantee on all service and repair



Brad Foote Gear Works, Inc.
1309 South Cicero Avenue
Cicero, IL 60650
312/242-1070

CIRCLE A-7 ON READER REPLY CARD

Checking Large Gears

Erwin J. Guenter
Maag
Zurich, Switzerland

Reliable Measurement—A Necessity for Economic Production

Gear manufacturing schedules that provide both quality and economy are dependent on efficient quality control techniques with reliable measuring equipment. Given the multitude of possible gear deviations, which can be found only by systematic and detailed measuring of the gear teeth, adequate quality control systems are needed. This is especially true for large gears, on which remachining or rejected workpieces create very high costs. First, observation of the gears allows adjustment of the settings on the equipment right at the beginning of the process and helps to avoid unproductive working cycles. Second, the knowledge of deviations produced on the workpiece helps disclose chance inadequacies on the production side: e.g., faults in the machines and tools used, and provides an opportunity to remedy them.

Selection of Measuring Methods

The application for which a gear is intended and its specified quality grade will determine which checking method should be used. Certain checking methods cannot serve as reliable criteria for gear performance in all cases. The radial (double flank) composite deviation test, for instance, is not a suitable checking method for gear speed and torque transmission capacity or for gear noise. Furthermore, one measurement may be substituted for another; for example, the tangential composite test for the cumulative pitch measurement. Therefore, it is neither economic nor necessary to measure every different kind of defined gear deviation, such as, run-out, radial or tangential (single flank) composite deviation, single pitch, cumulative pitch, profile and helix deviation, undulation and surface roughness. Which of the inspection methods should be applied depends chiefly on the function of the gear, on its quality degree, and sometimes also on the manufacturing method by which the gear teeth were machined.

In many cases other conditions are imposed by special acceptance regulations or by the limitations of available inspection equipment. Many gear accuracy characteristics are related to the gear axis. Therefore, two important machin-

ing and checking prerequisites and sufficiently accurate reference faces for determining the axis can be determined. On large gears, they are usually represented either by two sufficiently distant radial reference cylinders; e.g., by the bearing surfaces, or one radial and one axial reference face. (Fig. 1)

Individual Pitch Checking

Relative measurement

Up to now, individual pitch accuracy of large gears has generally been checked by applying the chordal (relative) measurement. With this method, the length of chord between the two contact points on two consecutive corresponding flanks is measured. The individual pitch deviation arrived at by this method is the difference between the actual measured value and the mean value of all measurements taken around the circumference.

Testers used for chordal pitch measurement usually bring two feelers into the tooth spaces to exactly the same depth. The gear under inspection is slowly turned and the feelers are moved in and out in an appropriate rhythm. (Fig. 2)

Absolute measurement

New developments in improved angular decoder systems allow the introduction of angular (absolute) measurement for large gears. Measurement is performed by controlling the dividing angle via optical or electronic instruments, whereby the feeler senses the actual position of the flank. (Fig. 2) Angular measurement supplies the individual pitch deviation as the difference between the readings on two consecutive flanks, minus the theoretical pitch.

Control of Individual Pitch Accuracy by Base Pitch Checking

Under certain conditions, control of uniformity of normal base pitches is a substitute for transverse individual pitch checking. This auxiliary method, usually performed by using a hand instrument according to Fig. 3, should, however, only be applied when the gear has not been machined with a multitooth cutter or with a single thread hob or grinding wheel. Otherwise, measured values would basically show only the pitch accuracy of the tool, but not of the gear. (Fig. 4)

Base pitch measurement is independent of the gear axis; any eccentricity of the gear does not influence the recorded result. Therefore, and also because the two feelers do not contact identical flank points, the base pitch checking cannot serve for determining cumulative pitch deviations.

AUTHOR:

MR. ERWIN GUENTER is a mechanical engineer employed by Maag Gear Wheel Company, Zurich, Switzerland. He has worked for Maag for thirty years and has been manager for research and development on gear checking machines and instruments since 1965.

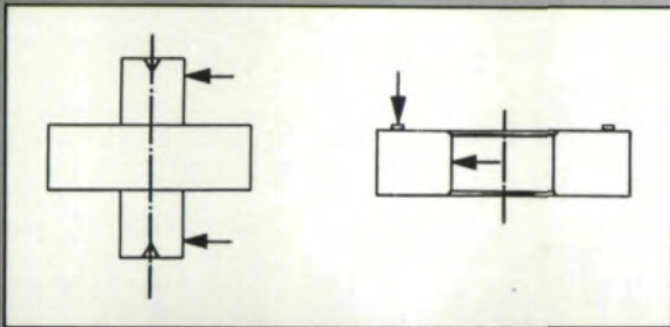

Fig. 1 - Definition of gear axis

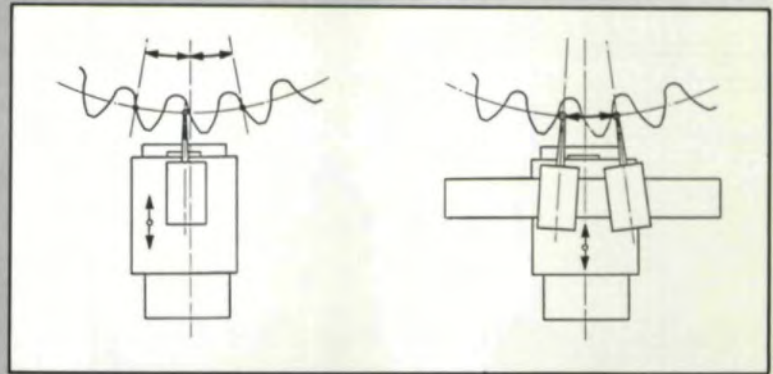

Fig. 2 - Relative and absolute individual pitch checking

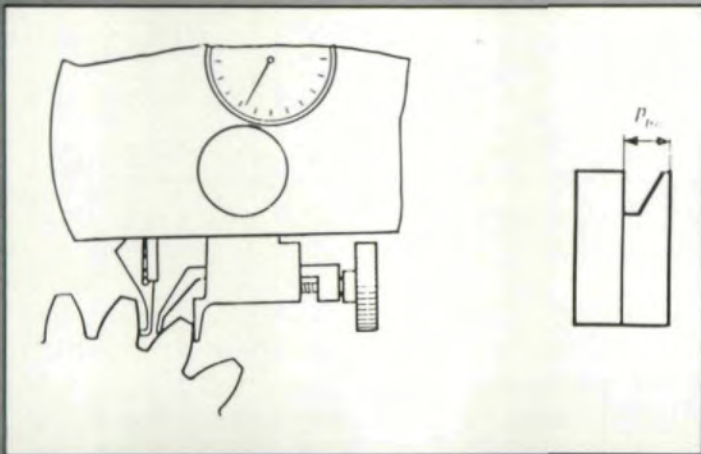

Fig. 3 - Base pitch measurement by hand instrument

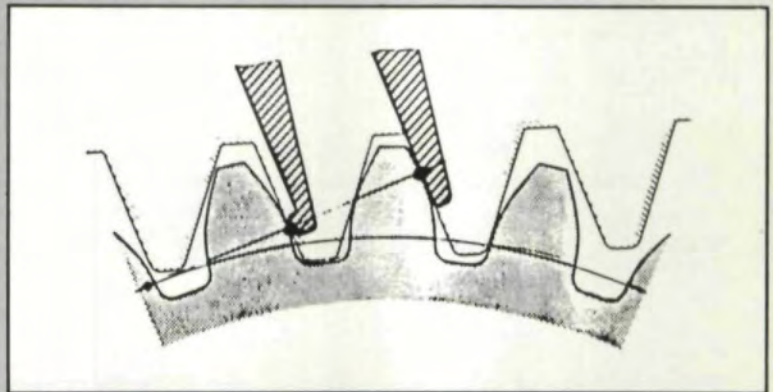

Fig. 4 - Identical simultaneous contact points on multi-tooth machining and on checking

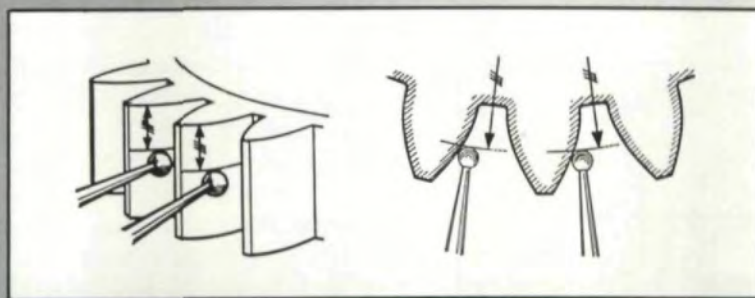

Fig. 5 - Setting of feelers for chordal (relative) pitch checking

Cumulative Pitch Checking

The cumulative pitch deviation between any two corresponding flanks can be determined by algebraic summation of the individual pitch deviations or of the span pitch deviations over the corresponding sector of circumference.

For determining the cumulative pitch deviation by chordal measurement, the two feelers must be set so that they contact as nearly as possible identical flank points at the moment when the reading is taken. (Fig. 5) This is in order to avoid accumulation of inadequacies of measurement due to irregular flank form and surface roughness. (Fig. 6)

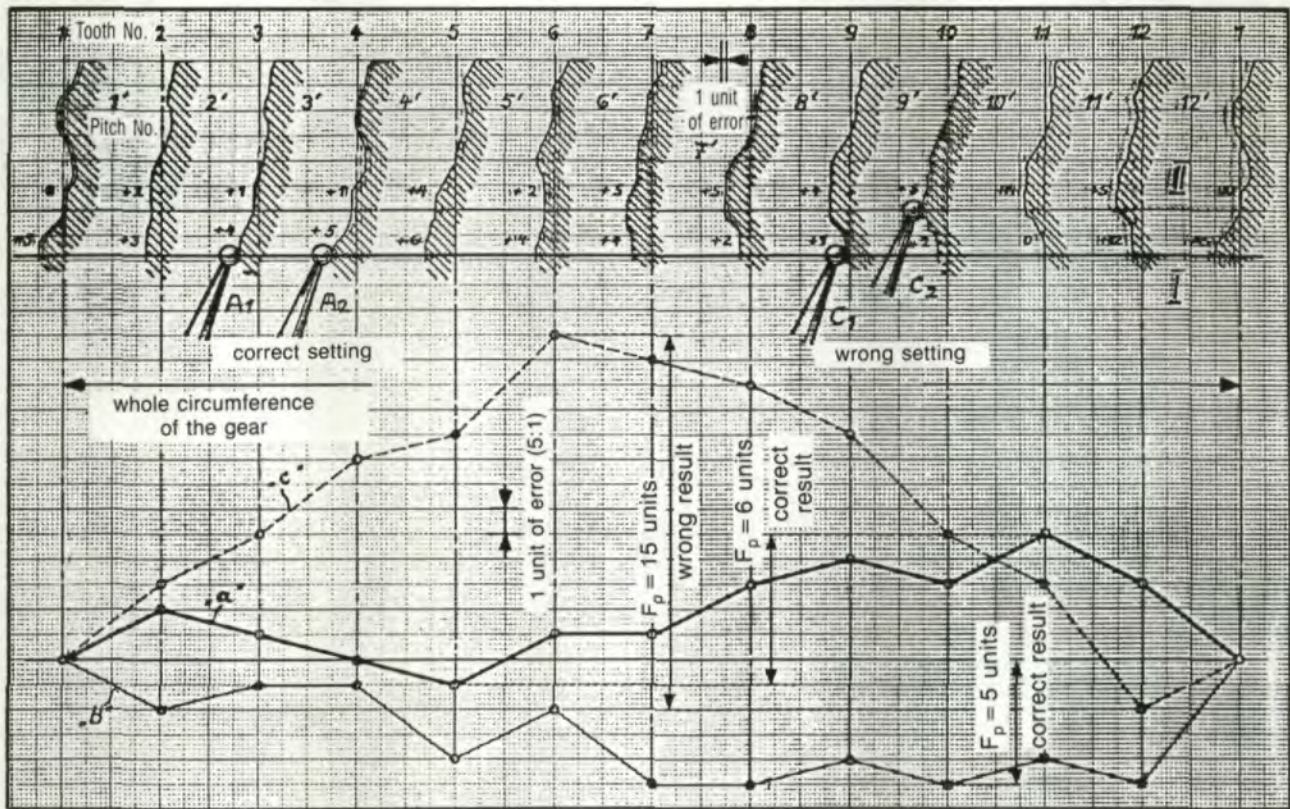

Fig. 6—Wrong checking results due to incorrect setting of feelers

Fig. 6 illustrates the schematic situation. With the feelers set in correct (identical) radial positions, A_1 and A_2 , (Plane I), curve "a" is established, and the total cumulative pitch deviation amounts to six units. In other correct settings; e.g., in Plane II, slightly different, but still correct, curves with a similar deviation (curve "b" with five units) would result. Results with different, but correct, probe settings can vary by the sum of the form deviations within the relevant part of both flanks.

If, however, the feelers are set incorrectly to different posi-

tions, C_1 and C_2 , curve "c" is obtained, the measuring result showing a total cumulative pitch deviation of 15 units, which in reality does not exist.

When applying the angular measurement, the cumulative pitch deviation results directly as the difference between the two readings of angles at both ends of the arc considered, minus the theoretical angle of the corresponding sector. The angle values are converted to length values by multiplication by the pitch radius.

Inspection by Sectors, Span Pitch Checking

If the cumulative pitch deviations are to be determined from chordal individual pitch measurements, substantial measuring errors can occur in the case of gears with a large number of teeth. These measuring errors are caused by the possible summation of errors of the many individual readings and by inadequacies of measurement due to irregular flank form deviations when the two feelers do not contact exactly the same flank points.

In order to reduce the number of readings and, hence, the uncertainty in checking, the use of "span pitch checking" (Fig. 7) is recommended.

With this method, the cumulative pitch deviation is not determined on each individual pitch, but on successive sectors containing a certain number of pitches.

The number of pitches per span is selected as, for example, to supply a sufficient number of plot points for the cumulative pitch deviation curve. On the other hand, it is limited with respect to practical and feasible instruments. A practical guide to the number of pitches (S) per span is ex-

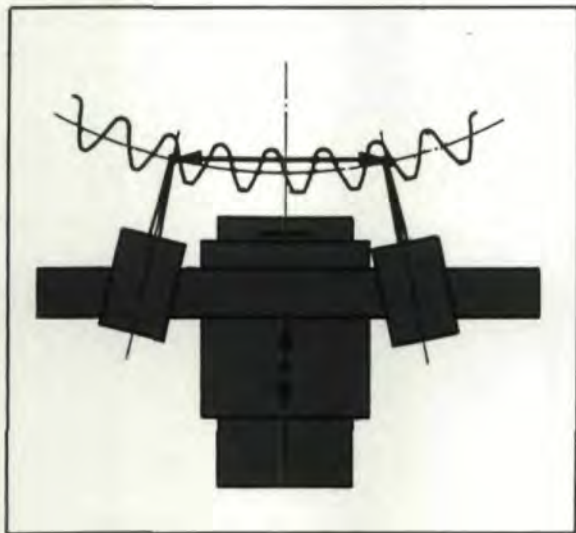

Fig. 7—Span pitch checking—inspection by sectors

GEAR HOBBLING FLEXIBILITY...



with CIMA-KLINGELNBERG

Optimum flexibility is achieved with 3 or 6 axis CNC controlled gear hobbing. Cima-Klingelberg Series Hobbers are perfectly suited for mass production of spur and helical gear sizes up to 15" O.D. Fully interactive with central computer systems (DNC), CK Series Hobbers can be furnished as complete systems to automatically accommodate similar part configurations. Systems can include automatic hob changing, part feeding, pre and post gauging and other ancillary systems.

Greater productivity is realized due to minimum downtime between cycles and higher cutting and feeding speeds. User-friendly CK Series Hobbers can be totally automated for even greater cost efficiency.

Higher quality and total repeatability are designed-in features of the CK Series Hobbers. AGMA - 11 quality is attainable.

Lower operating costs and higher quality levels can be yours with CK Series Hobbers. Isn't that just what you need to remain competitive in today's World Marketplace? Your first step may be to contact: Klingelberg Corporation, 15200 Foltz Industrial Parkway Cleveland, OH 44136
Phone (216) 572-2100
FAX (216) 572-0985.



CIMA



KLINGELNBERG

CIRCLE A-39 ON READER REPLY CARD

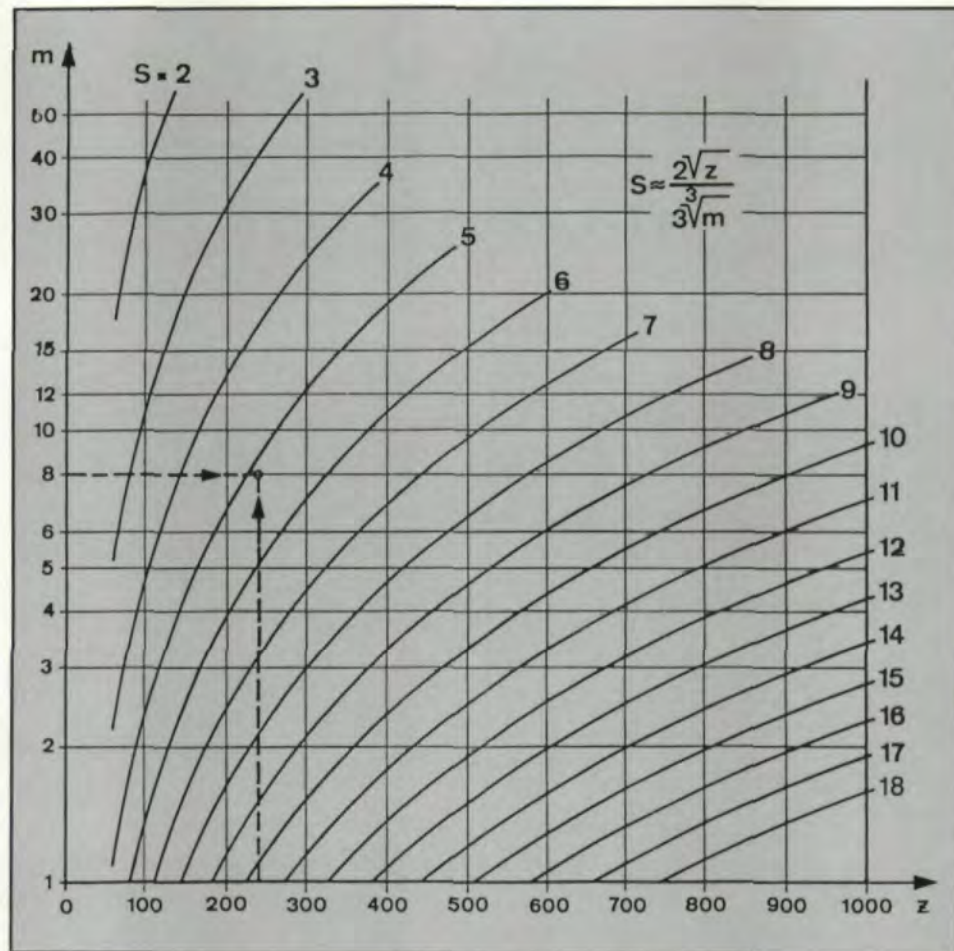

Fig. 8—Guide to the number (S) of pitches per span pitch checking

pressed by the formula and the diagram shown in Fig. 8. Nevertheless, the rules for setting the feelers must be observed.

Checking of Profile

Most testing instruments reveal the involute tooth profile by following the flank contour with a stylus and producing profile diagrams whereby the normal involute is represented by a straight line. The diagram length is equal or, if magnified,

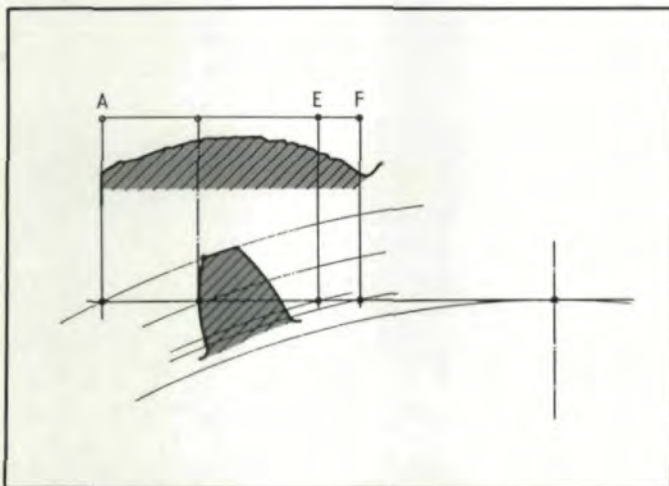

Fig. 9—Relation between involute tooth profile and profile diagram

proportional to the length, L_{AF} , of the base tangent between the two end points of the involute profile or the length, L_{AE} , corresponding with the active profile. (Fig. 9)

After checking, the actual profile is compared with the design profile (involute or modified involute) and the profile deviations are determined according to gear standards.

For recording the profile quality of very large gears, development goes mainly in the direction of applying measuring systems which are either transportable or fitted on to the gear production machine.

In cases where profile checking on large gears is not possible, the profile slope accuracy may be controlled by the auxiliary method of measuring the absolute value of the base pitch, for example, by using the hand instrument shown in Fig. 3. For this purpose, the instrument needs to be calibrated with an appropriate gauge. However, as measured values of base pitches are influenced by both pitch deviations and flank form deviations, this substitute procedure is only of reasonable use if pitch and flank form accuracy is very high.

Preferably, the actual absolute base pitch is determined as a mean value of several flanks. It must be assured that the measuring contact points do not lie in zones with profile or helix modifications.

With respect to the high costs of remachining a large gear, a "wrong" profile slope or pressure angle which does not correspond with the theoretical or the design value, in many cases is not corrected, but the mating pinion is machined to the same "wrong" value: If gear and mating gear have the

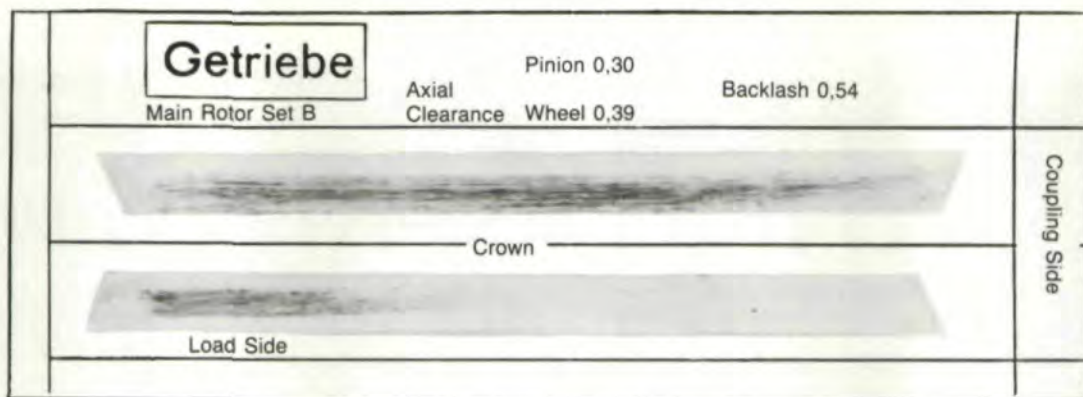

Fig. 10—Example of a recorded contact pattern configuration

same plus or minus profile slope deviation, the deviation is mutually compensated for and flawless meshing is attained in spite of the difference between theoretical and actual value.

Checking of Helix

Helix accuracy is usually depicted by the helix diagram, the length of which is equal or proportional to the usable face width. It shows the helix deviations relative to a straight line, the latter representing the unmodified pure helix.

In the past, for lack of checking equipment, the helix quality of very large gears and the mutual matching accuracy between gear and pinion have exclusively been inspected either by inserting a feeler guage between the flank and its mate flank or by examining the gear tooth contact pattern. By the latter means, a thin, even layer of blue or red dye is applied to a few consecutive teeth of the gear. Then, with the pinion shaft braked, the gear is rotated back and forth, so that the colored teeth pass through mesh several times. Fig. 10 shows an example of a recorded pattern configuration obtained by placing transparent adhesive tape to the pinion flank. This no-load tooth contact test (normally made on the working flanks, on a meshing rig or in the gear box) is performed on the non-working flanks if the working flanks are provided with relatively pronounced helix modifications, rendering them unsuitable for this test.

Helix misalignment, sometimes only ascertained when the gears are assembled in the gear box, is generally corrected by remachining of one of the mating gears or, especially in the case of single helical gears, by appropriate setting of specially designed adjustable bearings.

Newly developed more accurate checking equipment con-

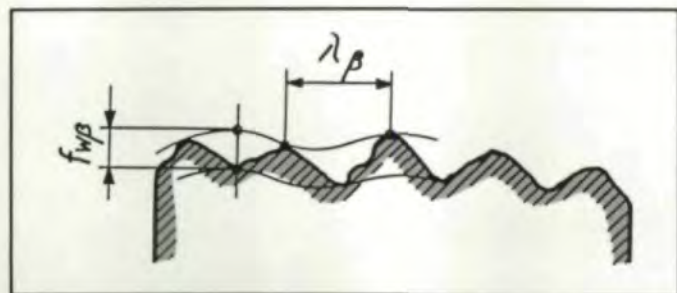

Fig. 11—Undulation diagram

tributes to more economical production of large gears in that the helix contour can be measured to a very high reliability, either directly on the production machine or on a gear measuring center. Together with the improved accuracy in machining the bores in the gear boxes, expensive adjustable bearings or even more costly remachining of gear elements can be avoided.

Checking of Undulation

The (helix) undulation is defined as the total wave height ($f_{w\beta}$) of waves of like height and like wave length (λ_{β}) along the helix of helical gears. (Fig. 11)

(continued on page 26)

Check Hardness of Fine Pitch Gears without Sectioning

THE MICRODUR ULTRASONIC HARDNESS TESTER

- TEST MORE GEARS
- TEST FINISHED GEARS
- TEST MORE TEETH PER GEAR
- TEST ON PITCH-LINE AND ROOT
- PRINT HARD COPY AND SPC STATISTICS

We can prove it. Our applications specialists are prepared to talk to you about your hardness testing requirements. Call or write to:

Krautkramer Branson
P.O. BOX 350,
LEWISTOWN, PA 17044
(717) 242-0327.

CIRCLE A-28 ON READER REPLY CARD

HURTH ZS 120 LINE OF C

Select the *"Just-Right"* unit for
from our wide range of

Operating and setting axes on ZS 120 TT

ZS 120T • ZS 120TT • ZS 120U Gear Shaving Machines

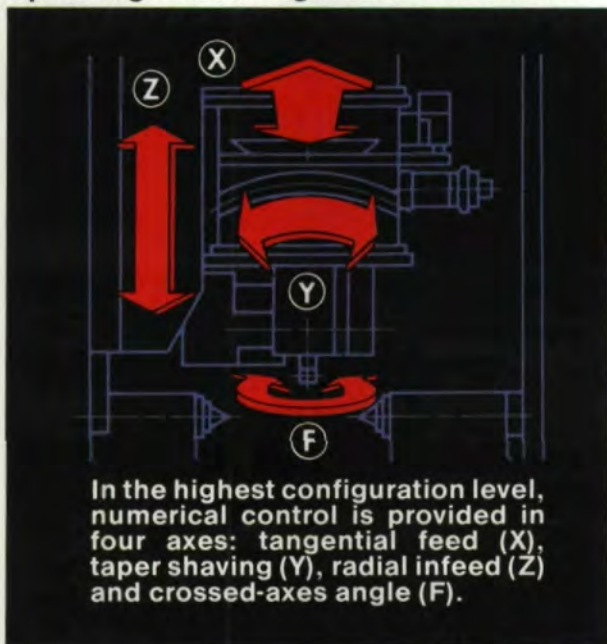

The ZS 120 line of gear shavers has been designed for high output and superior accuracy, together with modern production flexibility. Of the seven basic models, three perform plunge shaving, two perform plunge and/or tangential shaving, and two universal models perform all shaving operations including parallel, diagonal and underpass shaving.

All versions of the ZS 120 line are available with CNC to provide fast, uncomplicated change-over. Work cycles for plunge shaving as well as plunge/tangential shaving are preprogrammed in the control memory. Machines are specifically designed for applications in the automotive industry and for the small and medium-batch production of transmission units.

From manual work loading to a flexible manufacturing unit. All machines can be supplied with automatic work loaders. In addition, the ZS 120 is a highly efficient unit suitable for integration into completely linked lines for fully automated gear cutting and finishing. Finally, the design of the machine anticipates the integration of automatic tool change and work change equipment to turn the ZS 120 into a flexible manufacturing cell.



GEAR SHAVERS

for your applications
of models.

ZS 120 TT cutting zone

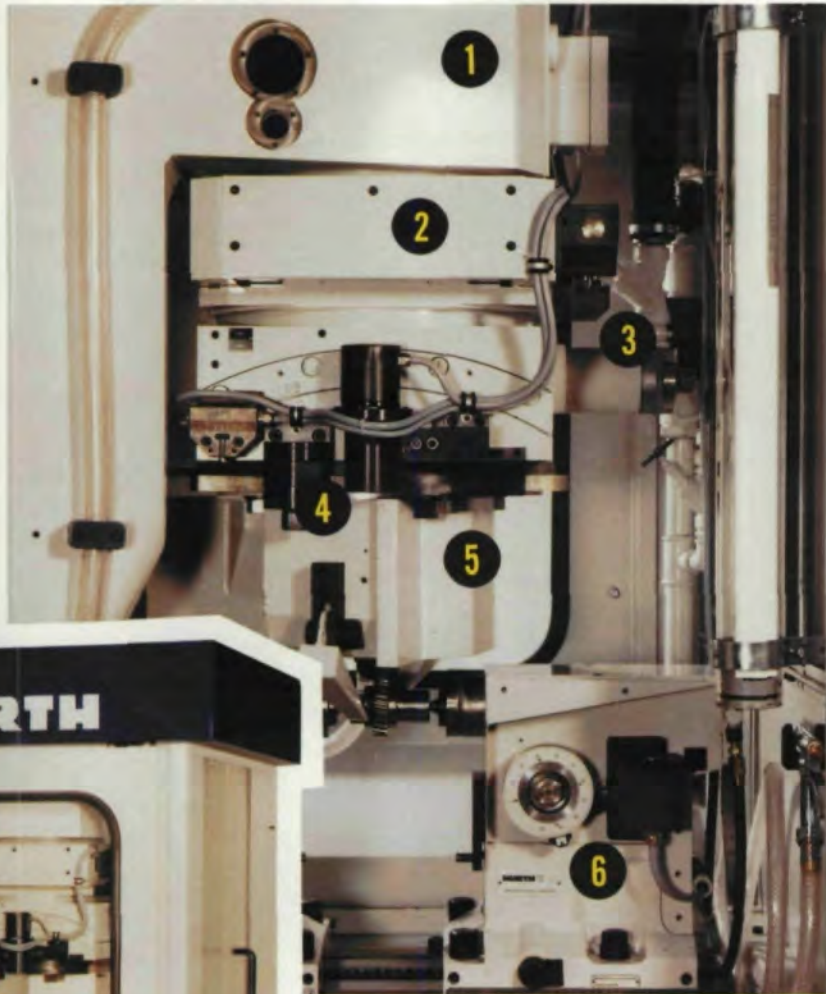

- 1 Vertical slide
- 2 Tangential slide
- 3 Taper adjustment
- 4 Adjustment of crossed-axes angle
- 5 Shaving cutter mount
- 6 Tailstocks

STARCUT SUPPLIED PRODUCTS AND SERVICES

Star Machine Tools

Standard and CNC Hob
Sharpeners
Shaper Cutter Sharpeners
CNC Drill and Reamer
Sharpeners

Star Cutting Tools

Hobs
Form-Relieved Cutters
Gun Drills
Gun Reamers
Keyseat Cutters

Gold Star Coatings

Lorenz
Shaper Cutters

Hurth Machine Tools

CNC Gear Shaving
Machines
CNC Gear Rolling Machines
Gear Testing Machines
Shaving Cutter Grinding
Machines
CNC Gear Tooth Chamfer-
ing Machines
Gear Deburring Machines
CNC Hard Gear Finishing
Machines

Hoefler

CNC Inspection Equipment
for Gears and Gear
Cutting Tools

TiN Coating Systems

Complete Turnkey
Applications

PLANRING USA, INC.

Planning & Engineering
Flexible Machining Systems

Stieber

Precision Clamping Tools

*Please contact us for complete
information on these gear shav-
ing machines and other StarCut
supplied products and services.*

 **Star**
Since 1927
STARCUT SALES, INC.
23461 Industrial Park Drive
Farmington Hills, MI 48024
313/474-8200 Telex 230-411

CIRCLE A-5 ON READER REPLY CARD

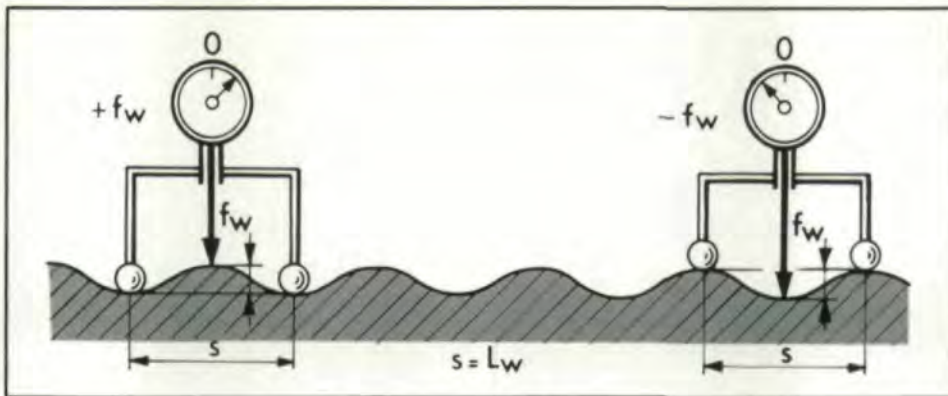

Fig. 12—Principle of undulation measurement

Due to the characteristic of equally distant flank deviations causing accelerations of constant frequency, even slight undulations can impair the performance quality (vibration, noise, surface load endurance) of a gear train considerably. Therefore, it is often necessary to restrict undulation amplitudes to relatively stringent tolerances. Generally, by projection on the circumference, the wave length allows determination of the number (n_M) of periodic machine disturbances occurring around the whole gear circumference. See below.

$$n_M = \frac{d \cdot \pi}{\lambda \beta \cdot \tan \beta} \text{ with } \lambda \beta \text{ in direction of axis}$$

$$n_M = \frac{d \cdot \pi}{\lambda \beta \cdot \sin \beta} \text{ with } \lambda \beta \text{ in direction of helix}$$

where d = pitch diameter, and β = helix angle.

As to the sources of helix undulations, those of particular interest are attributed to the worm gear mechanism of work tables of gear generating machines: The ridges and troughs of undulations caused by tooth meshing defects of the worm gear drive or by its location bearings run parallel or nearly parallel to the straight generators of the machined helical tooth flanks. If the worm gear drive uses a single thread worm, which is mostly the case, the projection of the undulation on the circumference of the gear represents an integral part of the whole circumference. Hence, the resulting meshing defect impairs the gear performance by an unbroken cyclic vibration. The number of undulations around the machined gear is equal to the number of teeth of the table worm wheel.

The relevant wave length appearing in the helix diagram or in the undulation diagram, related to direction of gear axis, is given by

$$\lambda \beta = \frac{d \cdot \pi}{\tan \beta}$$

Helix undulation measurements according to the principle of Fig. 12 show double the amount of the actual undulation error $f_{w\beta}$. Distance, s , between the sliding pads is to be set either to the supposed wavelength, β , or to an uneven multiple of it; with s equal to an even multiple of β , the recorded value would theoretically be zero.

Machines and Instruments for Checking Large Gears

According to the demands of industry, development of gear testing equipment has to assure utmost accuracy, ease of operation, and in the interest of economics, short measuring times. Because documented inspection has become more and more essential, automatic recording and analysis of measuring is also a requirement.

The instruments and systems described in the following are examples of developments embodying these aims.

Measuring Machines for Gears up to Two Meters

Machines have been designed for gears up to 2000 millimeters in diameter and up to a weight of 1200 kilograms. They are capable of checking profile, helix and, together with additional devices, pitch, run-out, undulation and surface roughness of tooth flanks.

Before starting the measurement, the stylus is automatically set to the flank to be checked. By means of the optional recording and analyzing system which incorporates a desk computer, the test results can be numerically recorded, stored, analyzed and plotted. The software system allows a wide selection of program options suited for individual requirements.

The typical measuring accuracy achieved on the checker can be quantified by the following formulas:

$$\text{Profile: } 0.35 + \frac{\psi}{28} + \frac{d}{2800} (\mu\text{m})$$

$$\text{Helix: } 0.35 + \frac{\sqrt{b}}{15 \cos \beta} (\mu\text{m})$$

whereby ψ = roll angle in degrees

d = pitch diameter in mm

b = face width in mm

β = helix angle

For a sample gear of 6.8mm module, 1800mm pitch diameter, 325mm face width, 18° helix angle and 3.3° rolling angle (root to tip), the measuring uncertainty for profile and for helix amounts to 1.1 and 1.6 μm , respectively, for typical absolute accuracy (U_{95}); 1.6 and 2.3 μm , respectively, for guaranteed absolute accuracy; 0.4 and 0.7 μm , respectively, for guaranteed repeatability.

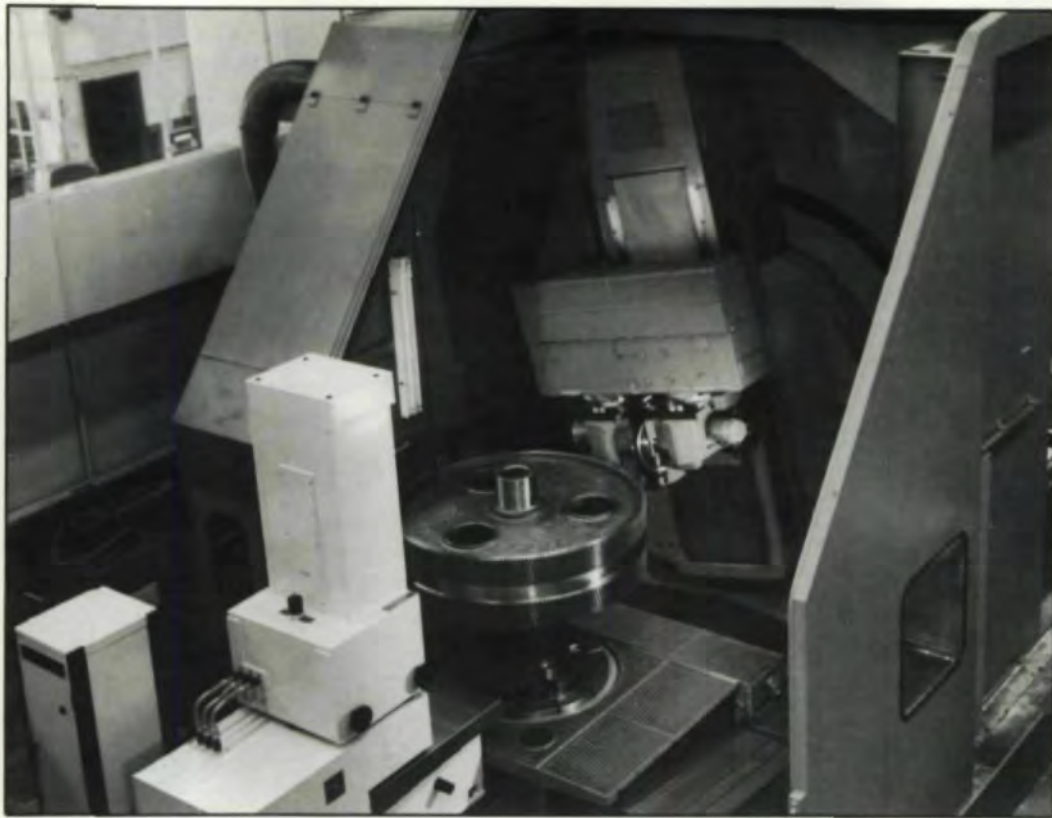

Fig. 13—Gear measuring system linked with a large gear grinder

CNC Pitch Checking Instrument

A mobile pitch tester can be employed universally, the only condition being a slowly rotating table for setting the workpiece or an equivalent drive system for a setup between centers. It is applied either directly on the machine tool or on a special setup for testing.

Mobile Profile Checking Instrument

Mobile instruments can be used for checking the profile accuracy on gears which are too large or too heavy to set up on a measuring machine.

As the checking is performed with the gear standing still, its axis being horizontal or vertical, measurement can be made in any circumstances: in between the machining cycles, on the machine tool, after machining with a simple set up on the floor, in the gear box assembly, etc.

Gear Checking System

Fig. 13 illustrates the configuration of a CNC gear measuring system adapted to a gear grinding machine. It allows checking and analysing of all important gear quality elements directly on the gear grinding machine without breaking the set up. Corrections to machine settings can be made quickly and without costly interruption of the machining cycles.

Acknowledgement: This paper was previously presented at the 2nd World Congress on Gearing, Mar. 1986.

GRATOMAT

PRECISION TECHNOLOGY

GEAR DEBURRING

Grinding • Brushing • Milling
Single & Multiple Station
Eliminate Tedious Hand Deburring
A Modest Investment With A Fast Return

211 East 18 Street, N.Y.C., N.Y. 10003
212-475-0082 Telex: 4997976

CIRCLE A-13 ON READER REPLY CARD

Influence of Geometrical Parameters on the Gear Scuffing Criterion – Part I

Dr. J. W. Polder
Nuenen, Netherlands

Abstract

To avoid scuffing* of high speed and highly loaded gears, a criterion different from the bending strength criterion (Galilei - Lewis) and the contact pressure criterion (Hertz) is needed. The Draft International Standard, DIS 6336, Part 4, now in print, still presents two scuffing criteria. The existence of two proposals impeded the progress of writing that standard for many years. As with Columbus' egg**, a simple solution to a difficult problem was found: the only factors which differed in both formulae were purely geometric, and the comparison was reduced to a simple mathematical comparison. The maximum contact temperature in the flash temperature criterion according to Blok was approximated by the integral temperature of the other criterion. All test results expressed in integral temperature are fully applicable to the flash temperature criterion, and in an unintentional way, these results confirmed the validity of the gear-scuffing criterion according to Blok, which is still the most practical.

In Part 2 it will be shown that all geometric influences may be concentrated in one factor dependent on only four mutually independent parameters. This simple fact will be used to examine the influence of different shapes and values of the load sharing factor.

Introduction

The load capacity rating of gears had its beginning in the 18th century at Leiden University when Prof. Pieter van Musschenbroek systematically tested the wooden teeth of windmill gears, applying the bending strength formula published by Galilei one century earlier. In the next centuries several scientists improved or extended the formula, and recently a Draft International Standard could be presented.⁽¹⁾

In the 19th century, metal gears suffered surface pitting which could not be predicted by the bending strength formula. Of necessity, material constants of the bending strength formula were considered empirically dependent on geometrical parameters. Attempts to find a relationship between "wear" and specific sliding were not successful. Nearly fifty years after its first publication, the theory of Hertz was

used for gear rating. Gradually, experience and test results could be transformed into several influence factors completing the contact stress formula. Even in the final stage of preparing the Draft International Standard,⁽¹⁾ the discussions about these influence factors did not stop.

The gear technology of the twentieth century allowed increasing loads and velocities at decreasing dimensions with new materials. Again, phenomena occurred which could not be predicted by existing formulae. The scuffing of gears was studied intensively and several criteria were proposed. Two categories of criteria may be distinguished:

1. The flash temperature criterion according to Blok, based on a realistic thermodynamic theory and confirmed by tests.
2. Empirical expressions yielding one representative value, mainly based on tests and, to a lesser extent, on theoretical considerations.

The flash temperature criterion was published by Blok in 1937.⁽²⁾⁽³⁾⁽⁴⁾ At the same time several tests were run. The lubricant was recognized as the third gear material and important progress was made in the development of additives to the mineral oils. An immediate application of the new theory would have been possible. However, a long delay was caused by World War II. When the Netherlands had to surrender to occupying forces in May 1940, Blok had to destroy all test results on the instruction of his employer, so after the war these could not be published in full.

Most expressions of the second category had a limited field of application and were not widely accepted. The best empirical criterion was Almen's factor, PVT. Afterwards, a relationship between PVT and the flash temperature could be shown:⁽⁵⁾ the square root of PVT approximates the maximum value of the flash temperature, keeping in mind that the jump from "force/time" to "temperature" is accounted for by thermodynamic constants. For a rough dimensional

**During a long, dull discussion, Columbus challenged his opponents to balance an egg on one of its ends. No one could do this until Columbus planted the egg firmly on the table, causing it to stand on its crushed shell, thereby proving that even the most perplexing problem may have a simple solution.

*Scuffing and scoring are synonyms for the same phenomenon. Since scoring may also have another meaning, the ISO Technical Committee 60 decided to apply the word scuffing in the ISO standards.

AUTHOR:

DR. J. W. POLDER has been involved in the study of gears and gear technology most of his adult life. He worked in industry for 10 years and received his doctorate in mechanical engineering from Eindhoven University of Technology in 1969. He continued work at the University until 1984 and is now in private research. He has published works on the theory of planetary gear trains and the theory of internal gears. He is a member of one of the Working Groups for Technical Committee 60, GEARS, of the International Standardization Organization.

The Logic behind Quality.

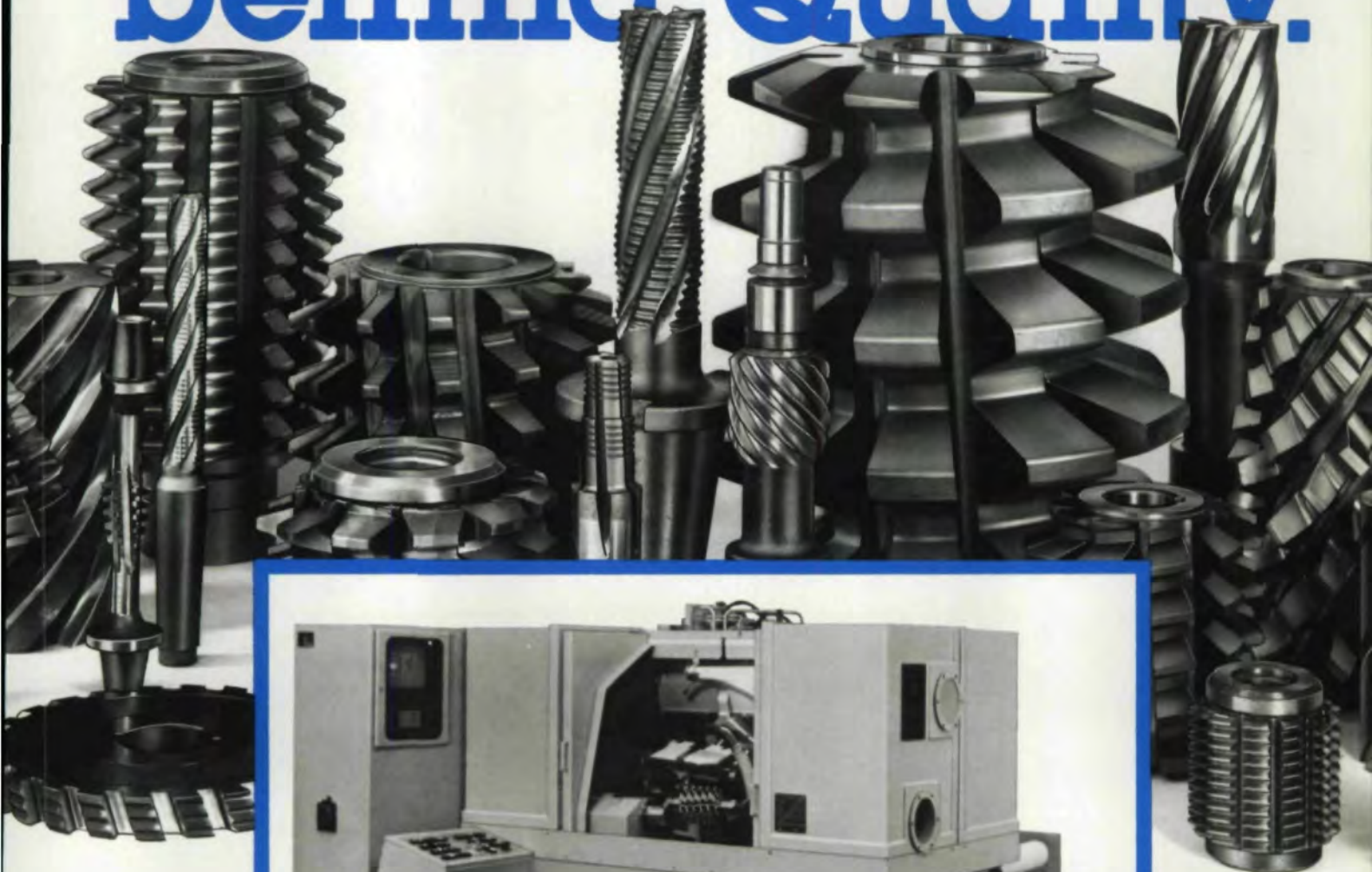

Logical Features

- 12" CRT Monitor
- Total CNC-controlled
- Diameters up to 14"
- Total wet machine — 57 gal./minute
- Computer Memory for up to 120 cutters
- Infinitely variable speed up to 52'/minute

Hob sharpening problems cost you time and money. Isn't it about time you take the logical road to quality and lifetime-precision?

You can start now by taking a close look at Klingelberg's SNC 30. And what you see will convince you.

Introducing the CNC-controlled SNC 30. It provides greater accuracy and grinding flexibility than previously available.

Computer memory masterminds the sharpening of any stored cutter with 100%-safety. The operating speed of the SNC 30 reduces grinding time in a way that really saves you money while a large CRT display monitors the sharpening process.

Klingelberg's state-of-the-art SNC 30 also features an electronic microcomputer and wet, grinding system.

Special accessories like a third and fourth axis are available to meet even highly sophisticated customer needs.

This is Klingelberg's precision and quality: No index plates, no sine bars, total CNC equals total performance.

If you have not seen the SNC 30, you have not seen "Hob sharpening by Logic" yet.

For more detailed information or a demonstration on the SNC 30 or any other Klingelberg systems, call or write Klingelberg today.

Representatives in principal cities.

Precision is our business.



KLINGELBERG

Klingelberg Corp.; 15200 Foltz Industrial Parkway
Strongsville, Ohio 44136; Phone 216/572-2100

CIRCLE A-9 ON READER REPLY CARD

Nomenclature

(Symbols, terms and units chosen in accordance with the international standard)

a center distance (mm)
 A point of path of contact at tip of wheel
 b facewidth (mm)
 B lower point of transverse single contact
 C pitch point
 C₂ weight factor (value 1,5)
 D upper point of transverse single contact
 E point of path of contact at tip of pinion
 F_t tangential force at reference circle (N)
 GAM parameter on the line of action
 GAMA parameter on the line of action at point A
 GAMAB parameter on the line of action between A and B
 GAMB parameter on the line of action at point B
 GAMD parameter on the line of action at point D
 GAME parameter on the line of action at point E
 GAMED parameter on the line of action between E and D
 S_B safety factor, Equation (18)
 TAA1 tangents of transverse tip pressure angle of pinion
 TAA2 tangents of transverse tip pressure angle of wheel
 TAT tangents of transverse working pressure angle
 trapez number corresponding with figure number of
 v pitch line velocity (m/s)
 W_{Bt} specific tooth load⁽¹⁾
 x₁ addendum modification coefficient of pinion
 x₂ addendum modification coefficient of wheel

X_B geometry factor, Equation (14)
 X_{BE} geometry factor at point E
 X_{Ca} tip relief factor⁽¹⁾
 XGAM load sharing factor
 X_M thermal contact coefficient, Equation (12)
 (K.N^{-3/4}.s^{1/2}.m^{-1/2}.mm)
 X_Q approach factor⁽¹⁾
 X_{top} form factor, Equation (11), (9) (K.N^{-3/4}.s^{1/2}.m^{-1/2}.mm)
 X_e contact ratio factor,⁽¹⁾
 X_Γ load sharing factor, Figs. 1 to 4
 z₁ number of teeth of pinion
 α_t transverse working pressure angle
 α_y pressure angle of arbitrary point
 β helix angle
 Γ linear parameter on line of action, Equation (14)
 Θ_B contact temperature, Equation (1) (°C)
 Θ_{Bmax} maximum contact temperature, Equation (9) (°C)
 Θ_{fl} flash temperature, Equation (2) (°C)
 Θ_{flaint} approximated mean value of the flash temperature, Equation (4) (°C)
 Θ_{flmax} maximum flash temperature, Equation (10) (°C)
 Θ_{int} integral temperature, Equation (3) (°C)
 Θ_M bulk temperature, Equation (16), (17) (°C)
 Θ_{oil} oil temperature (°C)
 Θ_S scoring temperature⁽¹⁾ (°C)
 μ_{mC} mean coefficient of friction at pitch point⁽¹⁾
 μ_{my} mean local coefficient of friction⁽¹⁾
 π product of factors in comparison, Equation (7)

analysis of some criteria, see Table 1, which demonstrates a certain progress towards the flash temperature criterion.

Table 1. Dimensional Comparison of Criteria

Hofer 1926: power/pitch surface	p^2v
Almen 1935: PV	$p \cdot v$
Almen 1943: PVT	$p \cdot v \cdot T$
Blok 1937: flash temperature	$(p^{1.5} \cdot v \cdot T)^{0.5}$
p=contact stress, v=velocity, T=length	

Some empirical expressions were based on an accumulation of energy along the path of contact. These expressions were rejected, one after the other, but the idea of accumulation⁽⁶⁾ turned up finally in the concept "integral temperature" presented in 1972 to the ISO Technical Committee 60 as an alternative to the flash temperature. The existence of two proposals impeded the progress of evolving an international standard. The possibility of rejecting either of them did not appeal to the committee, nor could a well-balanced combina-

tion be found for many years. Previous comparisons between the two methods were often based on the application of several influence factors in one method and neglecting those factors in the other, to the detriment of the latter.⁽⁷⁾

However, the discussions began again when a clear comparison was found,⁽⁸⁾ and in 1984 the deadlock could be broken, just in time to present the preliminary results in a Draft International Standard, together with the drafts on pitting and tooth breakage.⁽¹⁾

Comparison of the Two Methods

The Draft International Standard⁽¹⁾ still presents the two methods with a short comparison in the appendix. The first method is the flash temperature criterion according to Blok, supplemented with a few influence factors. The second method is the integral temperature criterion, including the same or comparable influence factors. The comparison takes account of those factors which are different in both formulae.

The flash temperature criterion concerns the contact temperature Θ_B which is a temperature function along the

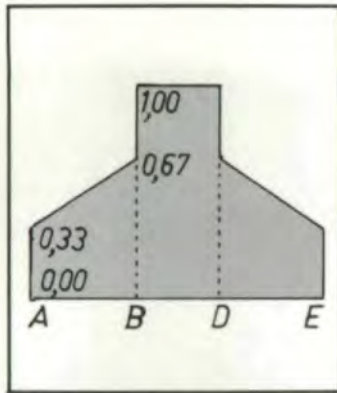

Fig. 1—Traditional load sharing factor for a gear pair with unmodified tooth profiles.

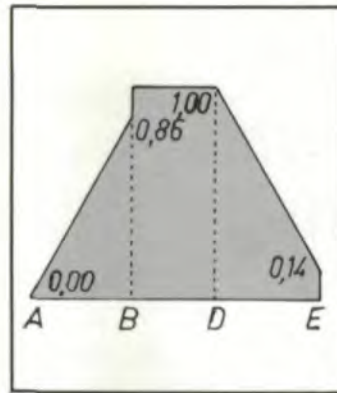

Fig. 2—Traditional load sharing factor for a gear pair with modified tooth profile, designed for high load capacity if the pinion is driver.

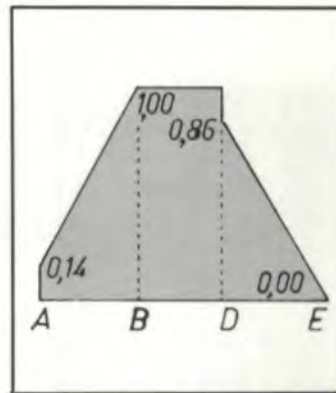

Fig. 3—Traditional load sharing factor for a gear pair with modified tooth profile, designed for high load capacity if pinion is follower.

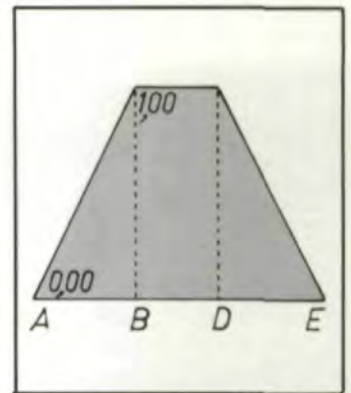

Fig. 4—Traditional load sharing factor for a gear pair with modified tooth profile designed for smooth meshing.

path of contact, defined as the sum of a constant bulk temperature Θ_M and a varying flash temperature Θ_{fl} .

$$\Theta_B = \Theta_M + \Theta_{fl} \quad (1)$$

$$\Theta_{fl} = \mu_{my} X_M X_B X_r \frac{W_{Bt}^{3/4} V^{1/2}}{a^{1/4}} \quad (2)$$

in which μ_{my} , X_B and X_r are dependent on the point of the path of contact considered.

The integral temperature criterion concerns a single value Θ_{int} , defined as the sum of the bulk temperature Θ_M and the mean value of the flash temperature along the path of contact Θ_{flaint} , multiplied by a weight factor C_2 .

$$\Theta_{int} = \Theta_M + C_2 \Theta_{flaint} \quad (3)$$

$$C_2 \Theta_{flaint} = \mu_{mC} X_M X_{BE} \frac{C_2 X_e}{X_Q X_{Ca}} \frac{W_{Bt}^{3/4} V^{1/2}}{a^{1/4}} \quad (4)$$

in which μ_{mC} is taken for the pitch point, X_{BE} is taken for the point, E, of the path of contact, and X_Q , X_{Ca} and X_e are empirical geometric expressions.

The bulk temperature Θ_M is the same in both criteria and can be left out of consideration. Hence, the comparison concentrates on the quantities defined in Equations (2) and (4). If the quantity defined by (4) is approximately the same as the maximum value of the flash temperature (2) along the path of contact, then the two criteria will be equivalent.

$$\left. \begin{array}{l} C_2 \Theta_{flaint} \cong \Theta_{fl} \quad \text{at one point} \\ C_2 \Theta_{flaint} \geq \Theta_{fl} \quad \text{elsewhere} \end{array} \right\} \quad (5)$$

The thermal flash factor, X_M , the specific tooth load, W_{Bt} , the pitch line, velocity, V , and the center distance, a , cancel out after substitution of (2) and (4) in (5). Rearrangement of the factors yields

$$\left. \begin{array}{l} \frac{\mu_{mC} X_{BE}}{\mu_{my} X_B} \frac{C_2 X_e}{X_Q X_{Ca}} \approx X_r \quad \text{at one point} \\ \frac{\mu_{mC} X_{BE}}{\mu_{my} X_B} \frac{C_2 X_e}{X_Q X_{Ca}} \geq X_r \quad \text{elsewhere} \end{array} \right\} \quad (6)$$

Now, the comparison between the flash temperature criterion and the integral criterion is reduced to a comparison of the product of empirical factors (mainly, part of the integral temperature formula) and the load sharing factor (to be applied in the flash temperature formula).

The Load Sharing Factor

The load sharing factor, X_C , accounts for the load sharing of succeeding pairs of meshing teeth. Dynamic effects due to vibrations of pinion and wheel are left out of consideration. The Draft International Standard⁽¹⁾ represents four variants of the load sharing, depending on the system of profile modification applied. See Figs. 1 to 4.

By convention, the load sharing factor is a discontinuous trapezoid function on the path of contact. The path of contact is marked on the line of action by the points, A to E.

DEBURRS GEARS FAST



★ SET-UPS
TAKE
SECONDS

★ INTERNAL-EXTERNAL
SPUR & HELICAL GEARS
TO 20 INCHES DIAMETER

11707 McBean Drive, El Monte, CA 91732
(818) 442-2898

CIRCLE A-11 ON READER REPLY CARD

See Fig. 5. It is composed of the approach path of transverse single contact, AB, the path of transverse double contact, BD, and the recess path of transverse single contact, DE.

The product of factors in the left member of (6), to be compared with the load sharing factor, is

$$p = \frac{m_{mC} \cdot X_{BE} \cdot C_2 X_e \cdot 1}{m_{my} \cdot X_B \cdot X_Q \cdot X_{Ca}} \quad (7)$$

The geometry factors, X_B , X_{BE} , the contact ratio factor, X_e , the approach factor, X_Q , and the tip relief factor, X_{Ca} , are defined by geometrical functions. Likewise, the quotient of the coefficients of friction, m_{mC}/m_{my} , is a geometrical function. The weight factor, C_2 , is a constant. Hence, the product p is a geometrical function on the path of contact.

The shape and value of p was examined numerically by computing it for a sufficiently large amount of data to cover the whole field of application. Such data may be selected adequately, keeping in mind that the geometry of a gear pair is determined by only seven independent parameters. Table 2 shows these parameters together with the fixed parameters of the standard basic tooth rack profile determining a gear pair. In this case, three of them, the center distance, the facewidth and the helix angle, can be left out of consideration. For 54 combinations of parameters, see Table 3. The product, p , was calculated separately for the cases pinion driver and follower.

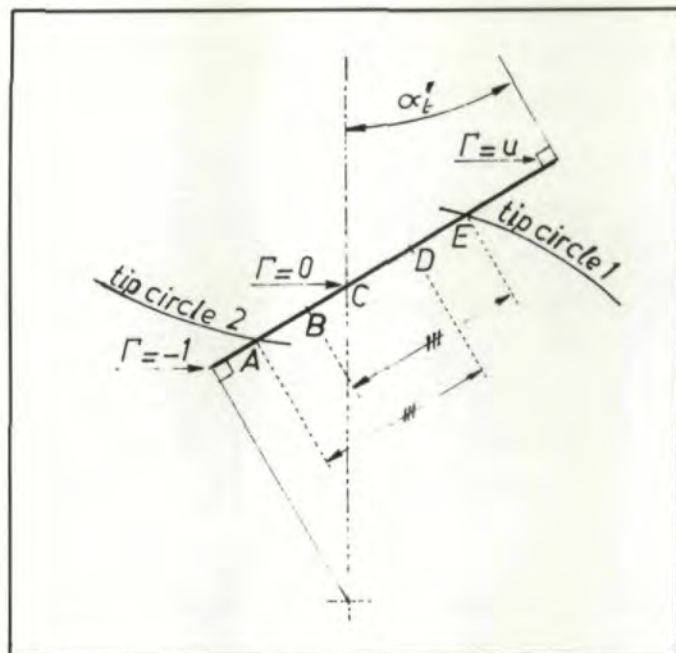

Fig. 5—Path of contact AD and parameter Γ on the line of action.

Table 2. Independent and Fixed Parameters

a	center distance
b	facewidth
b	helix angle
u	gear ratio
z_1	number of teeth of pinion
x_1	addendum modification coefficient of pinion
x_2	addendum modification coefficient of wheel

Table 3. Combinations of Parameters

u	z_1			x_1	x_2	
1	80	140	250	0.00	0.00	
2	45	80	140	0.20	-0.20	$(u\hat{1})$
4	25	45	80	0.40	0.00	$(u\hat{1})$
8	14	25	45			

The tip relief factor, X_{Ca} , according to the Draft International Standard⁽¹⁾ depends on the tip relief. That tip relief may be estimated to be proportional to the specific tooth load, F_t/b , and, therefore, it is roughly proportional to the modulus or to another dimension of the gear pair. However, the tip relief factor, X_{Ca} , should be a dimensionless factor and the complicated guiding line of the estimation of X_{Ca} seems to be incomplete. To continue the examination, the modulus of a test gear pair was chosen in the calculation procedure of the factor, X_{Ca} . The load sharing factor was taken for smooth meshing. See Fig. 4.

For each combination, the product, π , had about the same shape and value. The gear ratio, u , and the addendum modification coefficient of the pinion, x_1 , had the most influence. All other parameters had a low or negligible in-



Maschinenfabrik

FRÖMAG GmbH

our representative
R. J. Kemp
and associates SAE
38 W 510 Lake Charlotte Ct
St. Charles, IL 60174
Tel. 312-584-4488

Nobody

is able to deliver
Keyseating Machines with
more possible applications
for comfort and ease of
set-up!

In the margin, you can
see one of thousands of
special solutions we offer
our customers: machining
a keyway in a blind hole
with high precision using
a guided tool.

We offer other applica-
tions such as: tapered
keyways, tapered, inter-
rupted or stepped bores;
also internal multi-splines,
internal gearing and copy-
ing keyways.



The **NEW** ownership of Frömäg wishes
to announce its renewed commitment
to excellence in keyseating and
internal spline cutting.

CIRCLE A-16 ON READER REPLY CARD

fluence. The results in Figs. 6 to 8 answer surprisingly well the condition (5) for equivalence of criteria:

$$\left. \begin{array}{l} \pi \approx X_{\Gamma} \text{ along a part of the curve} \\ \pi \geq X_{\Gamma} \text{ elsewhere} \end{array} \right\} \quad (8)$$

This coincidence is not accidental, but is due to the extreme dependence of the integral temperature criterion on the flash temperature criterion. The rejection of one empirical criterion after the other and the steady acceptance of the flash temperature criterion on the one side and the recollection of the older concept of accumulation of energy on the other may have been a basis for the concept of the integral temperature.

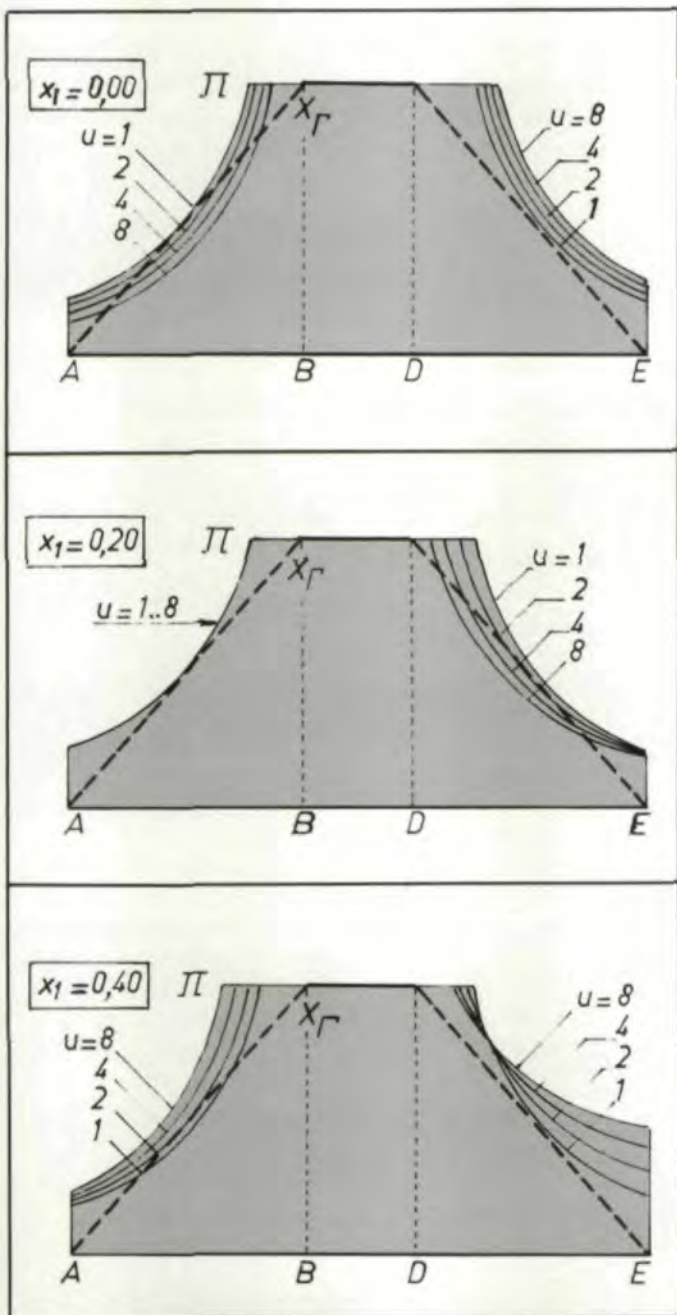

Fig. 6, 7, 8—Product of factors, Π , to be compared with the load sharing factor for smooth meshing.

In an unintentioned way the integral temperature criterion had to be supplemented with empirical constants, which brought the integral temperature value close to the maximum value of the contact temperature.

Comparison of Influence Factors

As mentioned before, previous comparisons were far from complete. However, the presentation of the two methods in the Draft International Standard, Part 4 and its appendix⁽¹⁾ created a better balance. The formulae of the two methods are identical in many respects and differ only in a few factors which have a geometrical meaning. The differing factors are partly systematic (mathematically precisely defined):

$$\begin{array}{l} \mu_{mC} \text{ versus } \mu_{my} \\ X_{BE} \text{ and } X_e \text{ versus } X_B \end{array}$$

The choice of the coefficient of friction, μ_{my} , in a varying point of the path of contact versus its choice to a fixed point, μ_{mC} , contributes unimportant differences.

The choice of the point, E, for the factor, X_{BE} in the integral temperature formula is arbitrary and only emphasizes the integral temperature as a single value, whereas the flash temperature, and in consequence the contact temperature, are functions of the path of contact.

The systematic factor, X_e is due to the concept of integration along the path of contact, reminiscent of the older concept of accumulation of energy. However, this physical interpretation is dubious and not necessary. Hence, the factor,

GEAR EXPO '87

YOUR BEST SALES OPPORTUNITY OF 1987!

America's Only Show Dedicated Solely to Gearing

Designed exclusively for suppliers of the gear industry. Our members — your customers — won't get lost in miles of unrelated exhibits. No where else can you meet so many customers — or potential ones — under one roof in a short period of time, with the added advantage of actually displaying your equipment instead of a catalogue.

Centrally Located

The 1987 show will be held Oct. 4-6, 1987, in the Cincinnati Convention Center, the heartland of the gear industry. Almost 80% of the industry is within two hours of the Gear Expo site.

Meet Your Competition . . . Exhibit at Gear Expo '87

For further information, contact Wendy Peyton at the American Gear Manufacturers Association, 1500 King Street, Suite 201, Alexandria, VA 22314, or call (703) 684-0211.

We're the people who know gears — we're the American Gear Manufacturers Association.

For further information, call or write TODAY:

Wendy Peyton: AGMA



1500 King St., Suite 201
Alexandria, VA 22314
(703) 684-0211

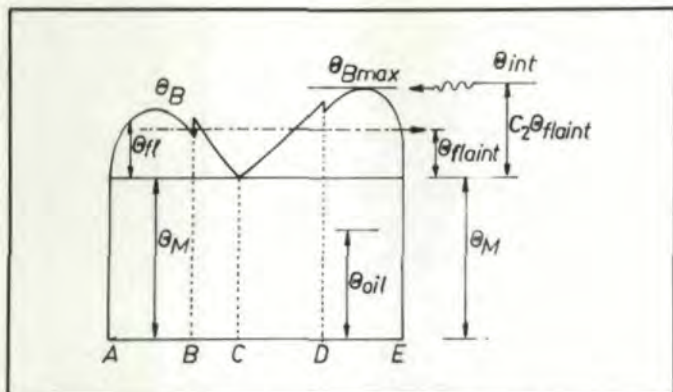

Fig. 9—The contact temperature θ_B varies along the path of contact. The integral temperature θ_{int} approximates the maximum value of the contact temperature.

X_t may be considered to be empirical.

The other factors which differ in both formulae are purely empirical.

$$C_2, X_Q, X_{Ca} \text{ versus } X_T$$

The factor C_2 is a constant (value 1.5). The factor X_Q varies from 1.00 down to 0.60, but for commonly applied gears, it seldom differs from the value 1.00.

The empirical factor, X_{Ca} , accounting for the influence of tip relief, is not decisive for a choice between the flash temperature method and the integral temperature method. The question how to improve X_{Ca} into a dimensionless

factor can be left out of consideration.

No other numerical difference exists between the two methods other than those expressed in the product of factors π compared with the load sharing factor. The deviation in calculated data of the integral temperature as compared with the contact temperature data is very small, provided a proper selection of the tip relief factor or the load sharing factor in both formulae is made. The two methods correlate to such a high degree that mutual independence has to be rejected. Moreover, it is a remarkable fact that the two purely empirical factors, C_2 and X_Q contribute a value, $C_2/X_Q = 1.5$, up to 2.5 by which the resulting "temperature" diverges from the mean temperature and approximates the maximum value closely. See Fig. 9. Hence, the integral temperature method denies its own concept of integrating, and it confirms the significance of the maximum value of the contact temperature.

In the statistical research of scuffing phenomena a larger deviation of observed data may be expected than known from corresponding tests of tooth strength or pitting, due to more uncertain influences of a hydrodynamic, thermodynamic and chemical nature. On account of the systematic dependence of the two methods deduced above, any assertion that the integral temperature method would be statistically superior to the flash temperature method is based on a misunderstanding.

References

- ISO 6336/1: Introduction and general influence factors.
ISO 6336/2: Calculation of surface durability (pitting).
ISO 6336/3: Calculation of root stress (tooth breakage).
ISO 6336/4: Calculation of scuffing load capacity.
ISO 6336/5: Material qualities and endurance limits.
In May, 1985, the above parts were approved for publication by ISO/TC 60 as Draft International Standards. These lengthy basic documents will be followed by simplified parts for several fields of application.
- BLOK, H., "Les Temperature de Surface Dans Des Conditions de Graissage Sous Extrême Pression." 2^{me} Congrès Mondial du Petrole, Paris, 1937.
- BLOK, H., "Measurement of Temperature Flashes on Gear Teeth Under Extreme Pressure Conditions." Proc. Gen. Disc. Lubr. Inst. Mech. Engrs., London, 1937.
- BLOK, H., "Theoretical Study of Temperature Rise of Actual Contact Under Oiliness Lubricating Conditions." Proc. Gen. Disc. Lubr. Inst. Mech. Engrs., London, 1937.
- POLDER, J. W., "Relation Between the PVT-Equation and The Flash Temperature Equation." Proc. Intern. Conf. on Gearing, London, 1958, page 473.
- NIEMANN, G. and SEITZINGER, K., "Die Erwärmung Einsatzgehärteter Zahnräder als Kennwert für Ihre Fresstragfähigkeit." VDI-Z. 113 (1971) 2, 97-105.
- WINTER, H. and MICHAELIS, K., "Scoring Load Capacity of Gears Lubricated With EP-Oils." *Gear Technology*, Vol. 1, No. 3, 1984. pp 20 f.
- POLDER, J. W., "Contribution to a Uniform ISO Scuffing Criterion." ISO/Technical Committee 60/Working Group 6, Document 280, May 1982.

Acknowledgement: This article was first presented at the 2nd World Congress on Gearing, March 3-5, 1986, Paris, France.



PEREZ MACHINE TOOL CO.

11 Ginger Court, East Amherst
New York 14051 • (716) 688-6982

Exclusive U.S.A. & Canadian Distributor for the Okamoto
SHG-360, 400, 600 Gear Grinders
GTP-200 & GTR Series Gear Tooth Chamfering Machines



Announcing our new Okamoto CNC High-Tech Form Grinder for creep feed or conventional spur gear grinder (internal and external) with a full 4-axis CNC control.

This CNC High-Tech Form Gear Grinder has been developed to respond to the growing users' needs of super-accurate and high efficient grinding of spur gears and similar profiled workpieces. The machine and the main spindle were designed to hold extreme rigidity and will prove its full capability with the use of CBN grinding wheels.

Specifications:

Max. outside diameter 24"
Min. root diameter 3/4"
Min./Max. D.P. 32 to 2
Max. number of teeth 600
Min. number of teeth 4

For more information or a quotation please contact us.

CIRCLE A-14 ON READER REPLY CARD

Appreciable Increases in Surface Durability of Gear Pairs with Mirror-Like Finish

S. Tanaka
A. Ishibashi
S. Ezoe

Saga National University, Japan

Abstract:

Teeth of test gears used in the main experiments were finished to a mirror-like surface with a roughness of about $0.1 \mu\text{m } R_{\text{max}}$ ($\approx 1.0 \mu\text{ in. Ra}$) using a new grinder with a cubic-boron-nitride wheel which was designed and made by the authors. Hardnesses of test gears were in the range 185 HB to 800 HV. An appreciable increase in the surface durability was obtained even when only the pinion (harder gear) was ground like a mirror. In this case, the tooth surfaces of the mating gear with hardnesses of 185, 300 or 400 HB improved because of effective running-in, and the duration of full EHL conditions increased up to 100% before 10×10^6 revolutions. The best result was obtained when the tooth surfaces of both the driver and follower were ground like a mirror with a roughness of about $0.1 \mu\text{m } R_{\text{max}}$.

INTRODUCTION

The reduction in the surface roughness of gear teeth can increase the surface durability of gears; however, it has been impossible to produce gears with tooth surface-roughnesses smaller than $0.5 \mu\text{m } R_{\text{max}}$ ($\approx 5.0 \mu\text{ in. Ra}$), even when gear

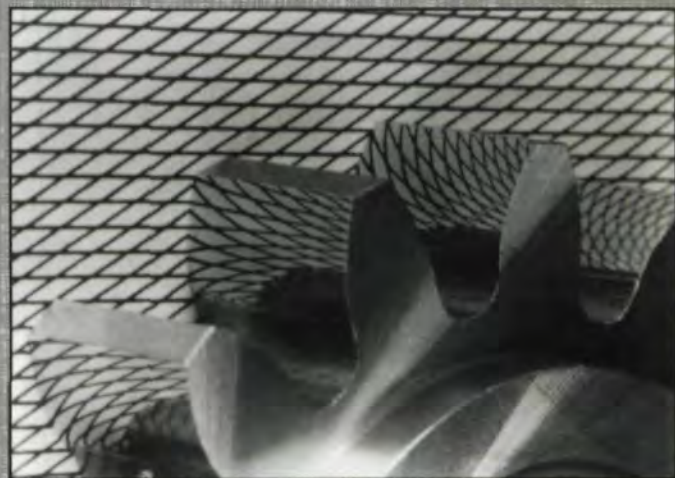

Fig. 1—Gear with mirror-like tooth surface.

AUTHORS:

DR. SHIGETADA TANAKA is Associate Professor of Mechanical Engineering at Saga National University, Japan. He has been in research on the load carrying capacities of gears since 1966 and has developed a new gear grinder with a cubic-boron-nitride wheel. He is a member of the JSME, the Japan Society of Precision Engineering and the Japan Society of Lubrication Engineers.

DR. AKIRA ISHIBASHI is a Professor of Mechanical Engineering at Saga National University, Japan. He is also director of the university's Laboratory of Machine Design and Manufacturing Technique. Since 1959, his primary research interest has been in the area of gear manufacturing techniques and load carrying capacities, and he has published the results of his work in the Transactions of the Japan Society of Mechanical Engineers. He is a member of JSME, the Japan Society of Precision Engineering, The Japan Society of Lubrication Engineers, and the Society of Automotive Engineers of Japan, as well as several other professional organizations.

MR. SATORU EZOE has a Bachelor of Engineering degree and is a Research Associate in the Department of Mechanical Engineering at Saga National University, Japan. His work has been mainly in the area of gear manufacturing techniques and load carrying capacities of precision gears. He is a member of the JSME, the Japan Society of Precision Engineering and the Japan Society of Lubrication Engineers.

grinders or gear shaving machines with the highest accuracy were used. Therefore, the surface roughnesses of test gears used for examining the surface durability in earlier experiments were greater than $0.5 \mu\text{m } R_{\text{max}}$ in almost all cases, excepting a single case in which the test gears were finished to a roughness of about $0.2 \mu\text{m } R_{\text{max}}$ by hand buffing.⁽¹⁾ In this case, an appreciable increase in the surface durability was not obtained because the waviness in the surface roughness could not be removed by buffing.

Recently, the authors designed and made a new grinder with a cubic-boron-nitride (CBN) wheel and succeeded in producing high accuracy gears with a very smooth tooth surface.⁽²⁾ When this grinder is used, the tooth surface can be finished to a roughness of about $0.1 \mu\text{m } R_{\text{max}}$ ($\approx 1.0 \mu\text{ in. Ra}$). Fig. 1 shows a spur gear ground by the authors' machine. The crossed lines on the floor are clearly seen on the surfaces of the gear because of a higher reflectivity on the tooth surfaces.

To determine the effects of roughness upon the surface durability of gears, the authors conducted endurance tests using gears finished by four different methods; mirror-like finishing with a CBN wheel, conventional grinding with an Alundum wheel, skiving with a carbide hob and conventional hobbing with a high speed steel hob.

Possibility of Increases in Surface Durability

The surface durability of a pair of gears is affected by many factors such as the roughness of gear teeth, rolling/sliding

speed at tooth surfaces, combinations of hardness and kinds of gear materials, etc. There are two theories about the origin a tooth failure. Conventional theory predicts that the origin is a crack which occurs at the subsurface on the assumption that there are no repetitions of plastic deformation at the contact surface.⁽³⁾ Another theory predicts that the origin of failure (fatigue crack) occurs at the contact surface because of insufficient oil film formation between teeth.⁽⁴⁾

When the origin of failure is at the subsurface, an appreciable increase in the surface durability cannot be expected without reducing the defects (soft inclusions, etc.) in gear materials. In the authors' experiences, the origin of failure occurs at the contact surface during loaded running in most cases, excepting some in which gear teeth are fully hardened.

In practice, it is important to know whether or not an appreciable increase in the surface durability can be obtained when the surface roughness is decreased. The authors estimate that there is a strong possibility of increasing appreciably the surface durability when the surface failure has occurred at Hertzian pressures less than $P_{max} = 0.3 HB'$ (MPa), where HB' is the Brinell hardness shown in terms of N/mm^2 . This estimation is applicable to the gears with hardnesses less than 450 HB.

An appreciable increase in the surface durability will be obtained when metallic contacts between meshing teeth are almost completely prevented by the reduction in roughness of the teeth.

Testing Machines and Test Gears

Testing machines. Effects of surface roughness upon the surface durability were appreciable when the gear pairs with a hunting gear ratio were used instead of the ones with a whole-number gear ratio.^(5, 6) Therefore, a gear load testing machine with a hunting gear ratio was used in the present experiments. This testing machine is of power circulation type and is capable of measuring the percentage (duration) of the full EHL conditions between meshing teeth.

The duration of the full EHL conditions was measured using an electric resistance method.⁽⁷⁾ Changes in voltage caused by the changes in the resistance of EHL oil film with some direct contact were recorded using a cathode-ray oscilloscope and a camera or a pen writing oscilloscope. The duration of the full EHL condition was calculated from $E \times 100/E_0$, where E is the measured voltage and E_0 is the ideal voltage which appears when the meshing teeth are separated fully by an oil film.

Test gears. Fig. 2 shows the size and shape of a pair of test gears with a hunting gear ratio of 1.08. Teeth of these gears are of standard type and have a pressure angle of 20° . The gear with the number of teeth, $Z_1 = 25$, was used as driver, while the one with $Z_2 = 27$ was used as follower. The profile contact ratio is 1.62 at a center distance of 78.00 mm.

Table 1 shows chemical compositions of test gear materials. The S45C steel is a plain carbon steel and corresponds to AISI-1045 steel. The SCM435 steel (\cong AISI-5135 steel) is a through hardening steel and the SCM415 steel (\cong AISI-4118) is a case hardening steel.

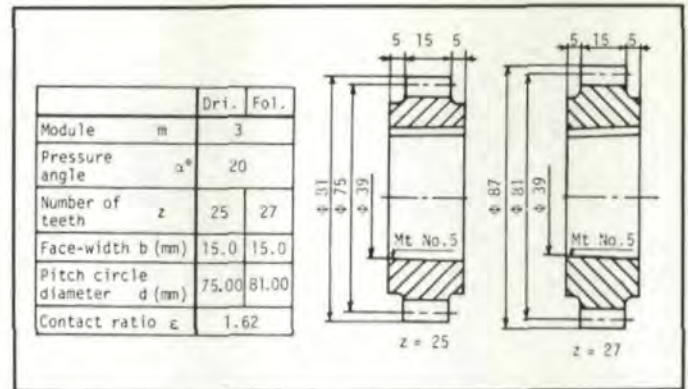

Fig. 2—Dimensions and shape of test gears.

Table 1 Chemical compositions of test materials

Kind of steels	Chemical composition (%)									Corresponding steel
	C	Si	Mn	P	S	Cu	Ni	Cr	Mo	
S45C	0.47	0.24	0.77	0.025	0.024	0.01	0.03	0.12	0	AISI 1045
SCM 435	0.35	0.25	0.77	0.021	0.030	0.07	0.06	1.12	0.16	AISI 5135
SCM 415	0.15	0.28	0.74	0.018	0.017	0.01	0.03	1.07	0.22	AISI 4118

Before making teeth, gear blanks made of S54C steel were normalized to a hardness of about 185 HB, and the ones of SCM435 steel were hardened and tempered to a hardness of about 300 HB. Some of the SCM435 steel gears were rough cut before hardening and then hardened and tempered to a hardness of about 400 HB. The SCM415 steel gears were rough cut, carburized for 2.5 hours and then hardened to a Vickers hardness of about 800 HV.

Test gears were finished by four different methods. The gears with hardnesses of 185 and 300 HB were finished by a high speed steel hob. All of the 400 HB gears and some of 800 HV gears were finished by a skiving hob made of cemented carbide.⁽⁸⁾ Most of the 800 HV gears and some of the 185 and 300 HB gears were ground to a roughness of about $0.1 \mu m R_{max}$; i.e., a mirror-like finish.

The surface roughness of the hobbled gears was about $10 \mu m R_{max}$. In contrast to this, the surface roughness of the skived gears was appreciably smaller; about $3 \mu m R_{max}$ for the 400 HB gears and about $2 \mu m R_{max}$ for the 800 HV gears.

Fig. 3 shows surface roughnesses of test gears with four different surface finishes. Fig. 3 (d) indicates a roughness of

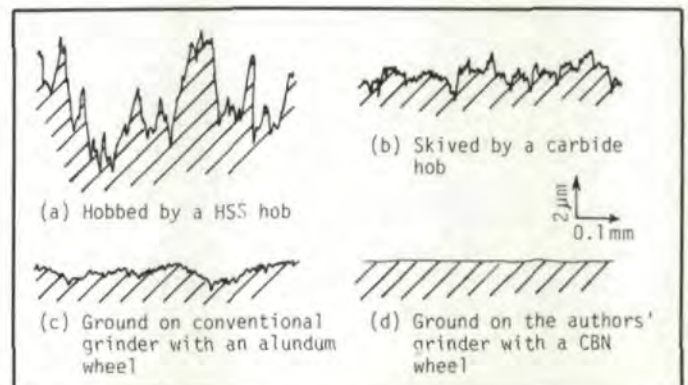

Fig. 3—Surface roughnesses of gear teeth.

about $0.1 \mu\text{m } R_{\text{max}}$. Fig. 4 shows tooth profiles of a 300 HB hobbed gear and an 800 HV ground gear with a mirror-like finish. Fig. 5 shows tooth traces of these gears.

Manufacturing errors of test gears are shown in Table 2. The pitch, tooth-trace and tooth-profile errors of the test gears with mirror-like tooth surfaces are very small and their accuracy grade is in the highest class for power transmission gears, according to the Japan Industrial Standard (JIS). For the sake of reference, the accuracy grades in AGMA and ISO Standards are also shown in the table.

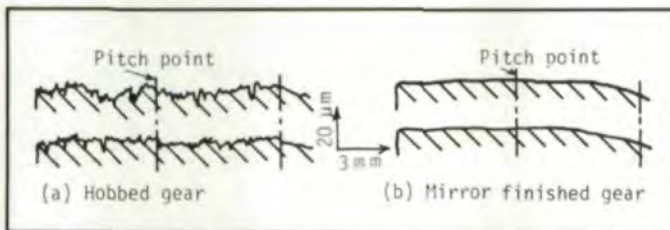

Fig. 4—Tooth profiles of test gears with 300 HB.

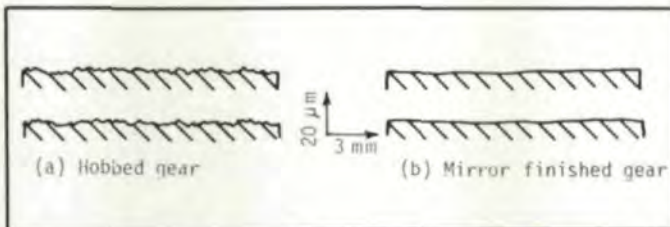

Fig. 5—Tooth traces of test gears with 300 HB.

Table 2 Accuracies of test gears

Finishing	Hobbing	Skiving	Grinding (Convent.)	Grinding (Mirror finish)	
Hardness	HB 185 - HB 300	HB 400 - HV 800	HV 800	HB 185 - HV 800	
Single pitch error (μm)	3 - 16	4 - 6	3 - 4	3 - 6	
Pitch variation (μm)	5 - 15	3 - 10	3 - 7	3 - 7	
Accumulative pitch error (μm)	6 - 20	6 - 10	6 - 10	6 - 10	
Tooth profile error (μm)	12 - 16	12 - 25	2 - 5	2 - 6	
Lead error (μm)	8 - 10	8 - 10	2 - 4	2 - 4	
Accuracy grade	JIS	3 - 4	3 - 5	0 - 1	0 - 1
	AGMA	9 - 3	3 - 7	12 - 11	12 - 11
	ISO	7 - 3	7 - 9	4 - 5	4 - 5

Running Conditions and Oil Film Thickness

Running conditions. After applying the tooth load, a test gear pair was rotated at a pinion speed of $n_1 = 1800$ rpm. As lubricant, a conventional gear oil with a viscosity of $63.5 \text{ mm}^2/\text{sec}$ (63.5 cSt) at 37.8°C was used. The oil was regulated to a temperature of about 40°C and flooded at a flow rate of about $300 \text{ cm}^3/\text{min}$ at a point above the meshing teeth of test gears.

The maximum Hertzian pressure at the pitch cylinder of test gears can be calculated from the following equation.

$$P_{\text{max}} = 19.60 \sqrt{P}, \text{ MPa} \quad (1)$$

where, P is the tangential load in N. It is assumed that there is no increase in load due to dynamic effects, and that the load distribution along tooth trace is uniform.

Theoretical oil film thickness. The theoretical oil film thickness h_{min} between meshing teeth was calculated from the Dowson's equation.⁽⁹⁾ Under the present experimental conditions, h_{min} was in the range of 0.4 to $0.5 \mu\text{m}$. The D value, $D = h_{\text{min}} / (R_{\text{max}1} + R_{\text{max}2})$, was about 0.03 when the hobbed gear was combined with the skived gear. This suggests that the metallic contacts between teeth are comparatively severe at an early stage of running. When both the driver and follower were ground like a mirror, the value of D was 2 , suggesting that the full separation of meshing teeth was caused by formation of EHL oil film.

Results of Endurance Tests

Table 3 shows the numbers given to the main experiments, combinations of gear materials, the surface roughness, the Hertzian pressure, the pitting area ratio, etc.

For 185 HB and 800 HV gears. When the 185 HB gears were used in equal hardness combinations, the surface durability (pitting limit) shown in terms of the Hertzian pressure was lower than $p_{\text{max}} = 780 \text{ MPa}$. Refer to Exps. (1) and (2) as shown in illustrations.

When the hardness of the driving gear was increased to 800 HV, the surface durability of the 185 HB hobbed gear increased by about 200 MPa in the case in which the 800 HV gear was ground or skived to a roughness of about $2 \mu\text{m } R_{\text{max}}$. When the 800 HV gear was ground like a mirror using the authors' grinder, the rate of occurrence of pits on the 185 HB hobbed gear was appreciably lower at the same load. See Exps. (5) and (6). When both the 185 HB and 800 HV gears were precisely ground like a mirror, the pitting area ratio after 31×10^6 revolutions was 0.58% at a higher Hertzian pressure of 1180 MPa . See Exp. (7).

Table 3 Numbers given to main experiments, combination of hardness, Hertzian pressure, etc.

No. of Exp.	Driver			Follower			Hertzian pressure MPa	Revolutions of follower	Pitting area ratio (%)
	Kind of material	Hardness HV (HB)	Surface roughness $R_{\text{max}} \mu\text{m}$	Kind of material	Hardness HB	Surface roughness $R_{\text{max}} \mu\text{m}$ (*)			
(1)	S45C	(185)	10 (H)	S45C	185	10 (H)	690	30×10^6	0.48
(2)	S45C	(185)	10 (H)	S45C	185	10 (H)	780	3.2×10^6	2.98
(3)	SCM 415	800	2 (S)	S45C	185	10 (H)	980	11×10^6	5.72
(4)	SCM 415	800	2 (G)	S45C	185	10 (H)	980	10×10^6	1.25
(5)	SCM 415	800	0.1(G)	S45C	185	10 (H)	980	20×10^6	0.16
(6)	SCM 415	800	0.1(G)	S45C	185	10 (H)	1180	20×10^6	0.57
(7)	SCM 415	800	0.1(G)	S45C	185	0.1(G)	1180	31×10^6	0.58
(8)	SCM 435	(300)	10 (H)	SCM 435	300	10 (H)	780	6.9×10^6	2.69
(9)	SCM 415	800	2 (S)	SCM 435	300	10 (H)	1180	12×10^6	1.12
(10)	SCM 415	800	2 (G)	SCM 435	300	10 (H)	1180	5×10^6	1.89
(11)	SCM 415	800	0.1(G)	SCM 435	300	10 (H)	1080	10×10^6	0.61
(12)	SCM 415	800	0.1(G)	SCM 435	300	10 (H)	1180	22×10^6	0.55
(13)	SCM 415	800	0.1(G)	SCM 435	300	10 (H)	1270	4.8×10^6	1.76
(14)	SCM 415	800	0.1(G)	SCM 435	300	0.1(G)	1180	24×10^6	0
(15)	SCM 415	800	0.1(G)	SCM 435	300	0.1(G)	1470	1×10^6	0 breakage
(16)	SCM 415	800	2 (S)	SCM 435	400	3 (S)	1180	10×10^6	3.30
(17)	SCM 415	800	2 (S)	SCM 435	400	3 (S)	1370	10×10^6	11.0
(18)	SCM 415	800	2 (G)	SCM 435	400	3 (S)	1180	13×10^6	0.74
(19)	SCM 415	800	0.1(G)	SCM 435	400	3 (S)	1180	11×10^6	0
(20)	SCM 415	800	0.1(G)	SCM 435	400	3 (S)	1230	11×10^6	0.11
(21)	SCM 415	800	0.1(G)	SCM 435	400	3 (S)	1270	11×10^6	0.25
(22)	SCM 415	800	0.1(G)	SCM 435	400	3 (S)	1370	11×10^6	0.81
(23)	SCM 415	800	0.1(G)	SCM 435	400	3 (S)	1470	11×10^6	1.66

* (H) Hobbed (G) Ground (S) Skived

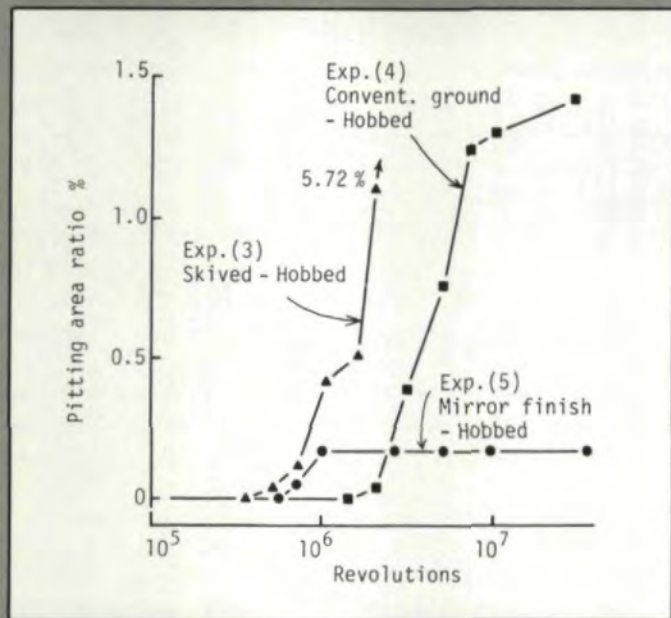

Fig. 6—Pitting area ratios on 185 HB gears.

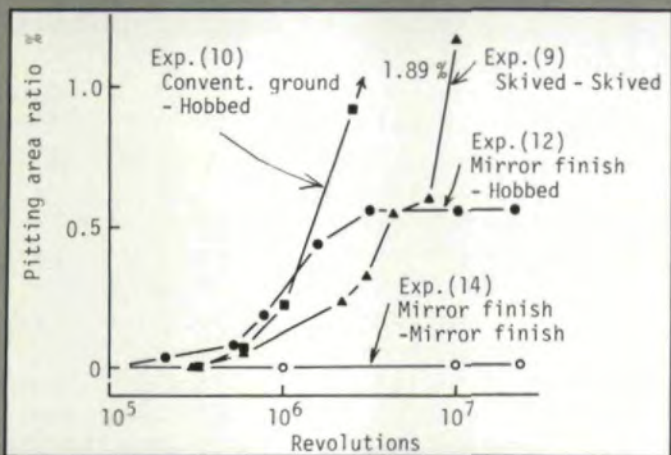

Fig. 7—Pitting area ratios on 300 HB gears.

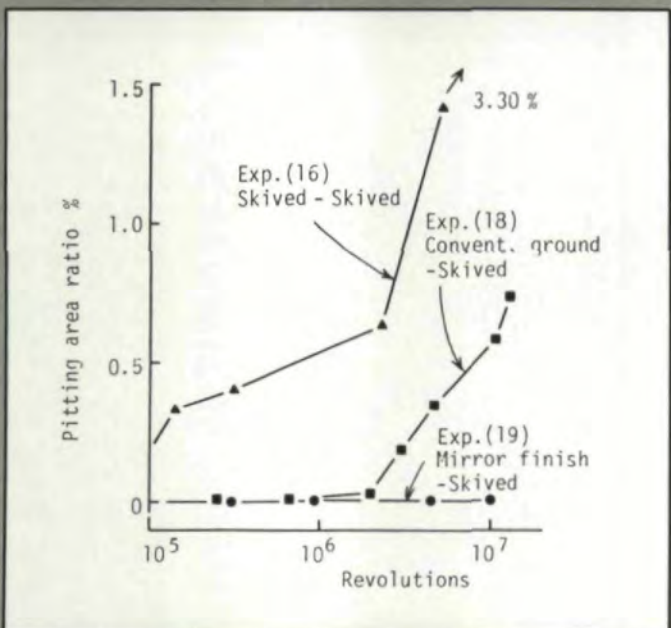

Fig. 8—Pitting area ratios on 400 HB gears.

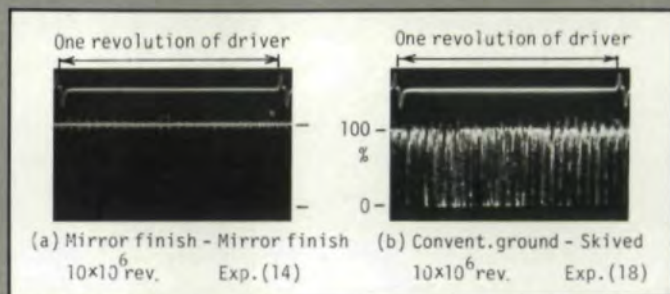

Fig. 9—Duration of full EHL conditions during one rotation.

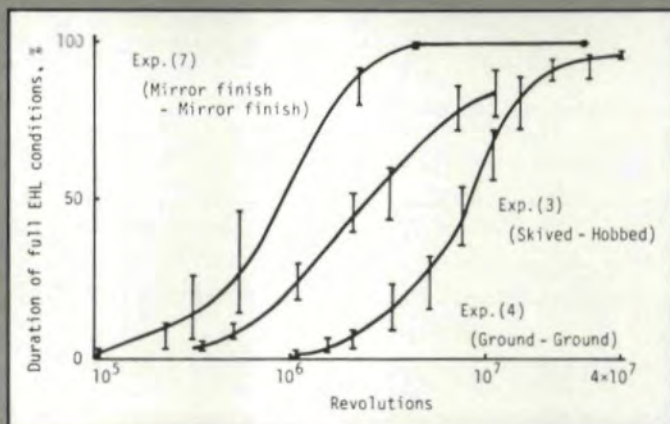

Fig. 10—Duration of full EHL conditions for 185 HB and 800 HV gears (Mean values over a long period).

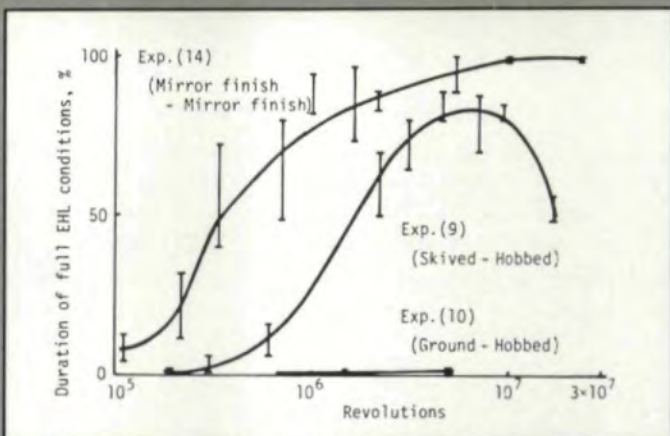

Fig. 11—Duration of full EHL conditions for 300 HB and 800 HV gears (Mean values over a long period).

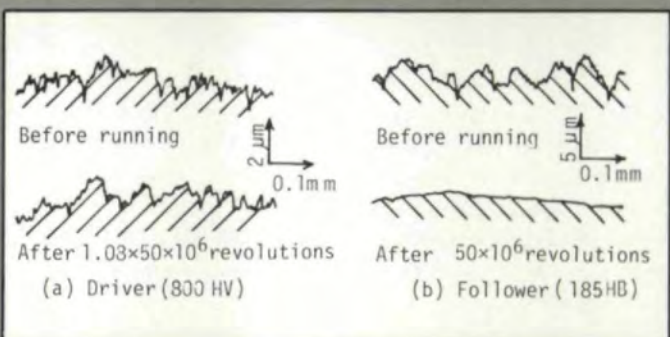

Fig. 12—Changes in tooth surface roughness [Exp. (4)].

Fig. 6 shows increases in the pitting area ratio on the 185 HB gears which were combined with 800 HV gears with different surface finish. When Exps. (1) and (7) are compared, one sees that the applicable load was increased by a factor of about three when the surface finish was improved like a mirror. This is the most beneficial effect brought about by the mirror-like finishing of tooth surfaces.

For 300 HB and 800 HV gears. When the 300 HB hobbled gears were used in equal hardness combinations, the pitting limit was less than 780 MPa. Refer to Exp. (8). When the hardness of the driving gear was increased to 800 HV, the pitting limit increased up to about 980 MPa in the case in which the surface roughness of the harder gears with skived or ground to a roughness of about $2 \mu\text{m} R_{\text{max}}$. See Exps. (9) and (10). When Exps. (7) and (10) are compared, one sees that the reduction in the surface roughness (mirror-like finishing) of the harder gear is more effective than increasing the gear hardness from 185 HB to 300 HB to obtain the higher surface durability.

Fig. 7 shows the pitting area ratios on the 300 HB gears which were combined with the 800 HV gears with different surface finish. When both the 300 HB and 800 HV gears were ground to a roughness of about $0.1 \mu\text{m} R_{\text{max}}$ (mirror-like finish), the pitting area ratio after 24×10^6 revolutions was about zero (less than 0.006%) at a Hertzian pressure of 1180 MPa; while it was about 1.89% after 5×10^6 revolutions at the same Hertzian pressure when the 800 HV gear was ground to a roughness of about $2 \mu\text{m} R_{\text{max}}$. See Exp. (10).

For 400 HB and 800 HV gears. When the 400 HB skived gears with a roughness of about $3 \mu\text{m} R_{\text{max}}$ were combined with 800 HV gears, an appreciable increase in the surface durability was obtained when the teeth of the harder gears were finished like a mirror. Refer to Exps. (19) to (23).

Fig. 8 shows the pitting area ratios on the 400 HB gears used in combinations with the 800 HV gears with different surface finish. In this case, the gear pairs were rotated at an equal Hertzian pressure of 1180 MPa. It is clearly understood that the mirror-like finishing of the harder gears is extremely effective for increasing the surface durability of the mating medium-hardness gears.

Duration of Full EHL Conditions

In order to explain the effectiveness of the mirror-like finishing of tooth surfaces, the duration of full EHL conditions were measured using an electric resistance method.⁽⁷⁾

Fig. 9 shows the duration of full EHL conditions during one revolution of the driving gear. When both the driving and following gears were finished to a roughness of about $0.1 \mu\text{m} R_{\text{max}}$ (mirror-like finish), the duration of full EHL conditions became almost 100% after 10×10^6 revolutions. See Exp. (14). However, when the surface roughness of the harder gear was about $2 \mu\text{m} R_{\text{max}}$, the duration of full EHL conditions was about 40% after 10×10^6 revolutions at the same Hertzian pressure. Fig. 9(b).

Figs. 10 and 11 show the mean values of the duration of full EHL conditions over a long period. From these figures, one can see that the reduction in the roughness brings about an appreciable increase in the duration of full EHL conditions. This suggests an appreciable reduction of metallic-

contact points at the contact surfaces. When the repetitions of plastic deformation caused by the metallic contact become negligible, the occurrence of pitting cracks will be prevented at the tooth surfaces. The degree of metallic contact at the tooth surfaces can be estimated from the workhardening at the contact surface.^(5,10)

The increase in the duration of full EHL conditions is the main reason for the improvement in the surface durability brought about by the mirror-like finishing of tooth surfaces.

Changes in Tooth Surface

Changes in surface roughness. The surface roughness of test gears was measured in the direction of tooth profile using a Talysurf roughness meter. Fig. 12 shows changes in surface roughnesses of the 185 HB hobbled gear and 800 HV ground gear which were used in Exp. (4). It should be noted that the surface roughness of the 185 HB gear decreased from about $10 \mu\text{m}$ to about $0.5 \mu\text{m} R_{\text{max}}$, but pitting occurred because the roughness of the 800 HV gear hardly changed. The reduction in the surface roughness of the 185 HB gear is not sufficient to prevent the metallic contact between meshing teeth because the theoretical oil film thickness is about $0.45 \mu\text{m}$.

Fig. 13 shows the surface roughnesses of a pair of gears with mirror-like finish. The tooth surfaces with mirror-like finish hardly deteriorated during loaded running for 31×10^6 revolutions at a higher Hertzian pressure of 1180 MPa.

DEBURR SIMPLE OR DIFFICULT GEARS

and smooth radii and edges on internal or external surfaces completely and efficiently time after time. ANODE MECHANICAL DEBURRING (AMD), invented and developed by Cation, combines a special moving tool-cathode with electrochemical metal removal. AMD removes heavy and irregular burrs with minimal effect on the stock. AMD is precisely controllable and repeatable. Edge break, radii and stock removal can be accurately pre-calculated and controlled.



AMD is stress free and applies to any stamped, machined or cast conductive metal. Use it productively on parts not responsive to vibration, tumbling and blasting.

AMD produces cost savings and deburrs where other methods can't.

CATION
CORPORATION

99 Ridgeland Rd.
Rochester, NY 14623
716-427-2460

CIRCLE A-40 ON READER REPLY CARD

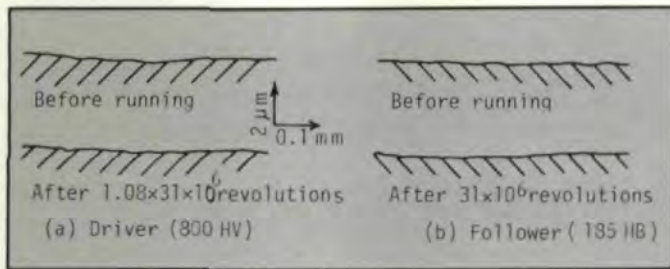

Fig. 13—Changes in tooth surface roughness [Exp. (7)].

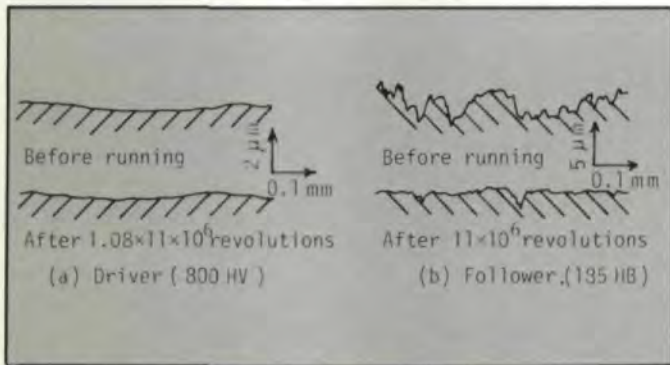

Fig. 14—Changes in tooth surface roughness [Exp. (20)].

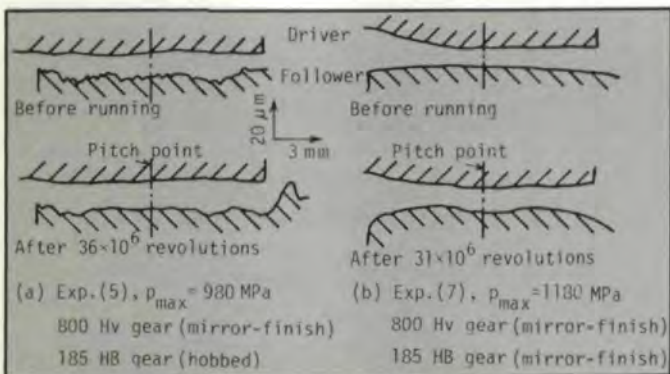

Fig. 15—Changes in tooth profiles.

Fig. 14 shows the reduction on the roughness of the 400 HB skived gear when the gear was combined with a 800 HV gear with mirror-like tooth surfaces. The tooth surfaces of the skived gear appreciably improved, but the mirror-like tooth surfaces hardly deteriorated during loaded running for 11 X 10⁶ revolutions. See Exps. (19) and (20).

Changes in tooth profile. Fig. 15 (a) shows changes in tooth profiles of the 185 HB hobbed gear and 800 HV gear with mirror-like tooth surfaces. These gears were rotated through 31 X 10⁶ revolutions at a Hertzian pressure of 980 MPa. The tooth profile of the 185 HB hobbed gear was hardly improved, but the surface roughness was appreciably improved because of running-in. Fig. 15 (b) shows changes in tooth profiles of the gear pair with mirror-like tooth surfaces. Some deterioration in the tooth profile was observed in the 185 HB gear with mirror-like finish because of a higher Hertzian pressure of 1180 MPa (0.65 HB'), which caused a plastic deformation at the subsurface where the reversed shear stress was maximum. However, the smoothness (reflectivity) at the surface was maintained until the end of loaded running in Exp. (7).

Fig. 16 shows changes in tooth profiles of gear pairs with a conventional surface finish. The deterioration in the tooth

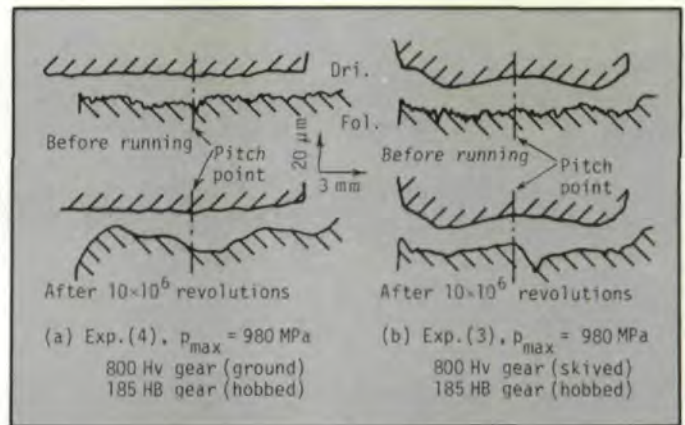

Fig. 16—Changes in tooth profiles.

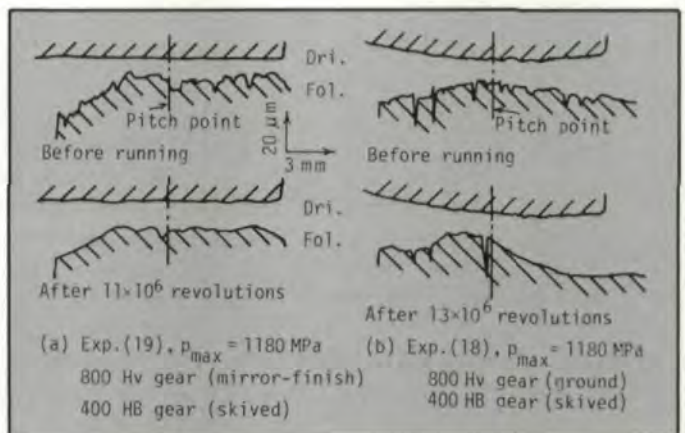

Fig. 17—Changes in tooth profiles.

profiles was appreciably greater, although the applied Hertzian pressure was lower by 200 MPa, when compared with the gear pairs with mirror-like tooth surfaces. Refer to Exp. (7).

Fig. 17 shows changes in tooth profiles of the 400 HB and 800 HV gears. The 800 HV ground gear with mirror-like tooth surfaces improved the tooth profile of the mating gear with 400 HB, while the conventionally ground gear deteriorated the tooth profile of the mating gear with 400 HB.

Changes in reflectivity. The reflectivity is a measure of smoothness at the ground surface or run-in-surface. The reflectivity of ground tooth surfaces with a roughness of about 0.1 μm R_{max} hardly decreased even after lengthy loaded running. Fig. 18 shows the tooth surfaces of the 300 HB and 800 HV gears which were rotated at a Hertzian pressure of 1180 MPa up to 24 X 10⁶ revolutions (for the follower). The crossed lines on the floor are clearly seen on the tooth surfaces after loaded running in Exp. (14).

Fig. 19 illustrates the fact that the tooth surfaces of the 300 HB hobbed gear became mirror-like because of running-in with the 800 HV ground gear with mirror-like tooth surfaces. The crossed lines on the floor are seen on the tooth surfaces of both the ground and hobbed gears which were rotated at a Hertzian pressure of 1180 MPa beyond 10 X 10⁶ revolutions.

Changes in Surface Hardness

Measuring an increase in hardness at the tooth surface after

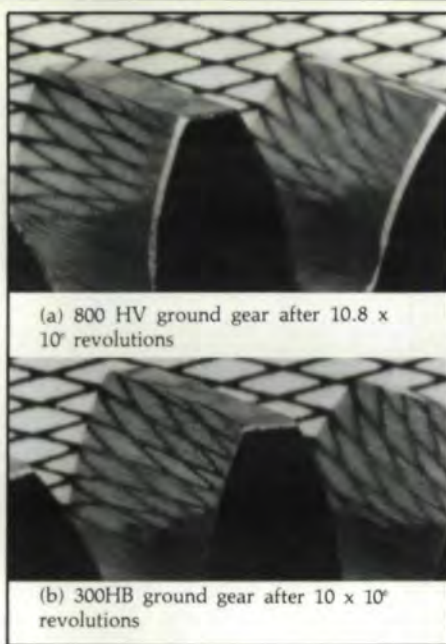

Fig. 18—Changes in reflectivity on tooth surface [Exp. (14)].

Fig. 19—Changes in reflectivity on tooth surfaces.

loaded running is a powerful tool for estimating the degree of plastic deformation which can cause pitting cracks at the tooth surface.⁽¹¹⁾ When the nearly full EHL oil film is formed between meshing teeth, the hardness at the tooth surfaces hardly increases and pitting cracks hardly occur at the surfaces.

Fig. 20 shows the hardness distributions at and near contact surface of the 185 HB gears which were rotated in combination with the 800 HV gears with different surface finish. When the 185 HB hobbed gear was combined with the 800 HV gear with conventionally ground surfaces or with skived tooth surfaces, the hardness of the hobbed gear became about 500 HV and, in some cases, increased up to about 650 HV at the surface of the teeth. In contrast to this, when the tooth surfaces of the 800 HV gear were finished to a roughness of about $0.1 \mu\text{m } R_{\text{max}}$ using the authors' grinder, increases in the hardness were hardly observed at the tooth surface of the 185 HB hobbed gear as seen in the lower part of Fig. 20. It should be noted that some increases in the hardness at the tooth surfaces had been brought about by hobbing. For reference purposes, the distribution of hardness at and near the tooth surfaces of the 185 HB hobbed gears before loaded

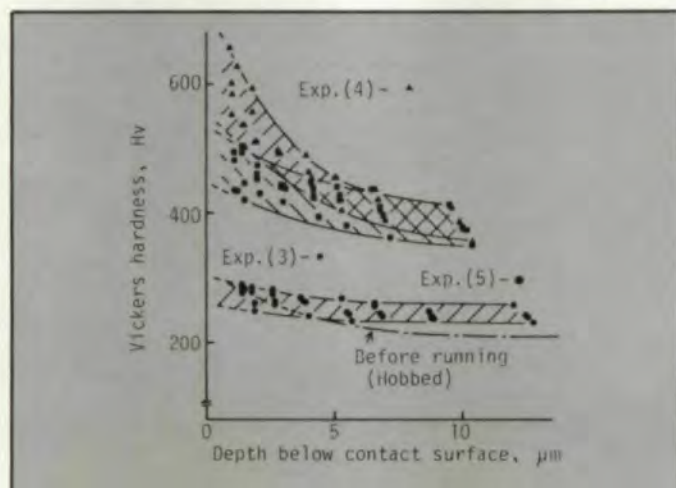

Fig. 20—Changes in surface hardness of 185 HB gears.

running are indicated approximately by the chain lines in Fig. 20.

Fig. 21 shows changes in hardness of the 300 HB gears which were combined with the 800 HV gears with a different surface finish. From this figure, it is understood that the increases in the hardness are more remarkable than those in Fig. 20. When the 300 HB gear was combined with the 800 HV gear finished by conventional grinding or skiving, the surface hardness of the 300 HB gear increased up to about 800 HV, but many pits occurred. This is because this increase in hardness was produced by the repetitions of plastic deformation at the contact surface. In contrast to this, when the tooth surfaces of both the 300 HB and 800 HV gears were finished like a mirror, the increases in hardness were very small, as seen in the lower portion of Fig. 21.

Discussion

In order to clearly show the beneficial effects of the mirror-like finishing of tooth surfaces, the roughnesses of tooth surfaces were analyzed using a Talysurf roughness meter and an electronic computer.

At first, the Abbott's bearing area curve and the fullness ratio⁽¹²⁾ of the tooth surfaces of teeth with three different finishes were calculated. Values of the fullness ratio are $K = 0.49$ for conventionally ground teeth and 0.5 for both the skived and mirror-like teeth.

The difference in the fullness ratios is very small, and it cannot be used for explaining the changes in the surface durability obtained in the present experiments. Therefore, the authors proposed the "generalized fullness ratio" shown in Equation (2).

$$K'_i = \frac{(H_{\text{max}, 1} - H_{\text{max}, i}) + H_{\text{mean}, i}}{H_{\text{max}, 1}} \quad (1)$$

$$= 1 - \frac{H_{\text{max}, i} (1 - K_i)}{H_{\text{max}, 1}} \quad (2)$$

$$K_i = \frac{H_{\text{mean}, i} \times L_0}{H_{\text{max}, i} \times L_0} \quad (3)$$

where, $i = 1, 2, \dots, n$ and n is the number of test surfaces. $H_{\text{max}, 1}$ is the height of the highest top of the roughness curve, with a measuring length of L_0 for the roughest surface (1). $H_{\text{max}, i}$ is the height of the highest top of the roughness curve of the other surface (i). The conventional fullness ratio K_1 for the test surface (i) is given by Equation (3). Equation (2) becomes equal to Equation (3) when $i = 1$. H_{mean} is the mean height of roughness.

The calculated values of the generalized fullness ratio are $K'_1 = 0.49$ for the conventionally ground teeth, $K'_2 = 0.68$ for the skived teeth and $K' = 0.97$ for the mirror-like teeth. These values can be obtained from Fig. 22 in which the

(continued on page 48)

BACK TO BASICS...

Economics of CNC Gear Hobbing

Dr. G. Sulzer
Liebherr Machine Tools
Kempton, West Germany

In our March/April, 1986 issue, Dr. F. Sulzer discussed some of the technical and production advantages of CNC gear shaping. Now we bring you the sequel to that article, which discusses some of the economic factors to be taken into consideration when converting to NC or CNC gear cutting.

Conventional Hobbing Machine versus CNC Hobbing Machine

NC and CNC metal cutting machines are among the most popular machine tools in the business today. There is also a strong trend toward using flexible machining centers and flexible manufacturing systems. The same trend is apparent in gear cutting. Currently the trend toward CNC tools has increased, and sophisticated controls and peripheral equipment for gear cutting machines are now available; however, the investment in a CNC gear machine has to be justified on the basis of economic facts as well as technical advantages.

The reason for the rapid introduction of numerical control in gear cutting is the trend toward ever decreasing batch sizes and the increasing variety of current components. (Fig. 1) Machine changeovers are more frequent and productive utilization of the machine is too low.

On the other hand, the investment for a full CNC hobbing machine is considerably higher. Balancing these two factors, it becomes obvious that CNC hobbing is more economical than conventional hobbing, especially if many of the added features of a CNC machine are used. These extra features, such as, 2-cut

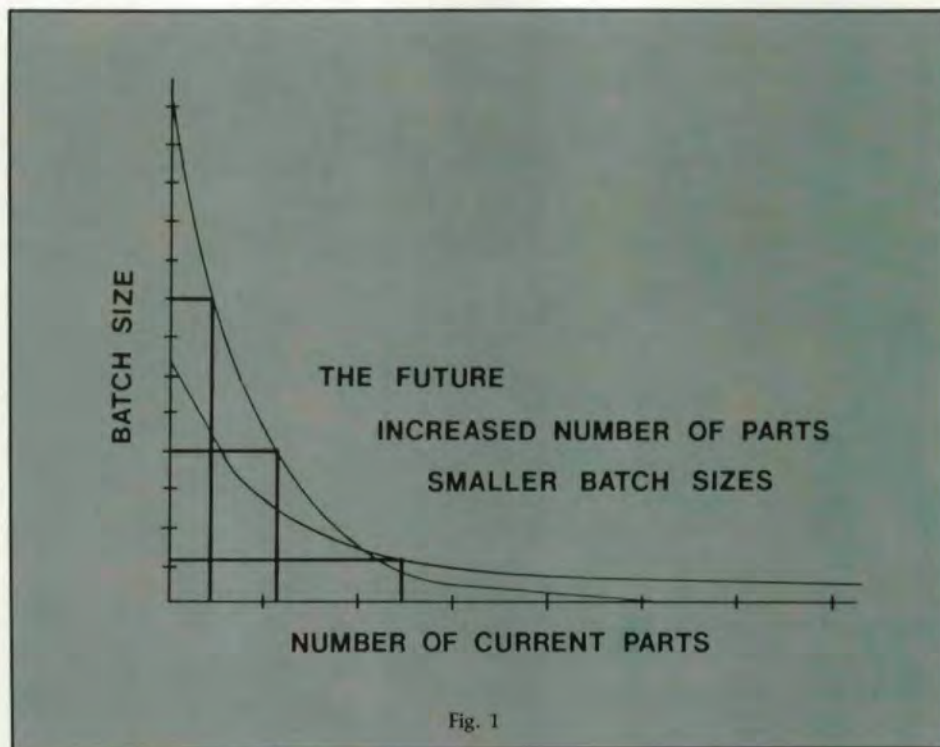

Fig. 1

cycles, copying, feed control, etc. are expensive in conventional machines.

The remaining question is how much sophisticated periphery, such as automatic fixture change, automatic part gauging, can be afforded.

Due to their complex kinematics and the high accuracy requirements, hobbing machines represent a special branch of machine tools. Hence for a long time, suitable NC controls for these machines were not available and machine tool manufacturers were forced to make developments of their own. This is especially true for the precise synchronization of hob and workpiece rotation. (Fig. 2) This problem is now solved, and today

the whole range of hobbing machines covering one inch to 40 feet in gear diameter is available in full CNC versions. With the high cost of gears above 40 inches in diameter, machines are equipped with special features in case of power failure and emergency shut-down of the machines.

Cycle Times (Fig. 3)

In reducing the production time for any gear, it is necessary to cut down both idle and cutting times. With NC technology, cutting times can be reduced by 10-20%. This saving is achieved through the use of special feed control, without overloading the hob. During

AUTHOR:

DR. G. SULZER is Manager of Research & Development at LIEBHERR in West Germany. He earned his doctorate at the University of Aachen in Aachen, Germany where he has worked in the role of Manager of Research Development for twelve years. He has been instrumental in the development of the Liebherr CNC machines.

● For gear hobbing:

1. radial travel
2. axial travel
3. tangential travel and
4. rotation of hob
5. table rotation
6. hob head swivel

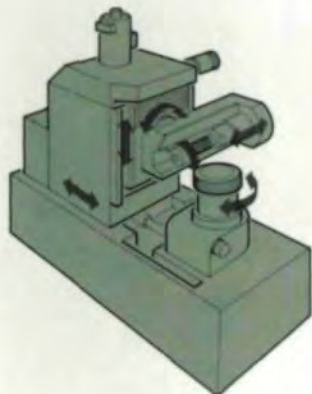

Fig. 2

radial or axial approach, the hob is only partially used, chip thickness is small, and the cutting path is short because of the small angles of action. With the use of degressive control for both speed and feed, time savings can be achieved.

Feed commences approximately 1.5 times normal, and the hob speed is approximately 1.3 times normal. When using a two-cut cycle, feed and speed can be increased during the exit of the tool on the first cut (progressive control). Multistart, tin-coated hobs can be fully used on modern CNC machines. These machines provide for the necessary hob and table speeds and power requirements.

CNC hobbing machines offer higher gear qualities with the same cutting conditions when compared with conventional machines. This applies especially to the lead, because on NC machines there is no longer a gear train which may distort under load. Thus, with quality requirements remaining the same, CNC hobbing machines allow higher feeds.

The second important factor influencing the cycle time is idle time. With NC control, the hobbing machine has shorter travels. The switching points are positioned more accurately and repeat more constantly. Additional safety travels as used on manual machines are obsolete. All necessary travels are calculated by the control; thus, allowances are kept to

Cycle times

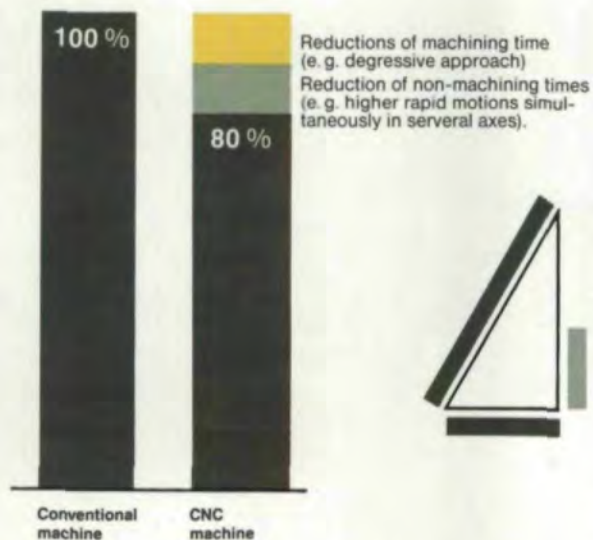

Fig. 3

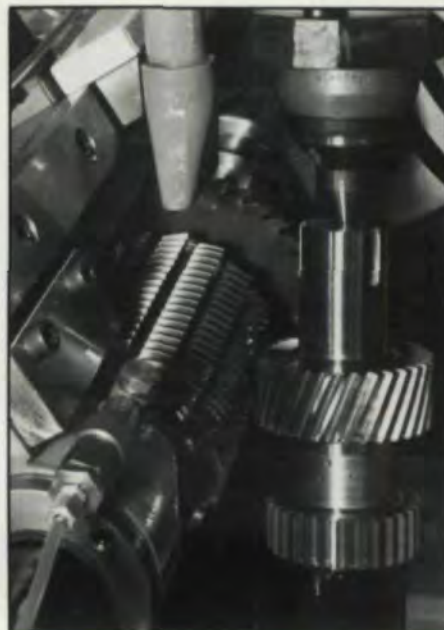

Fig. 4

a minimum. On top of this, the traverse rates of an NC machine are three to four times faster than those of a conventional machine, and several movements can be carried out simultaneously.

Additional savings can be made through the combination of several operations in one clamping of the workpiece. (Fig. 4) Two different gears on one component can be cut in one operation. The tools required may be

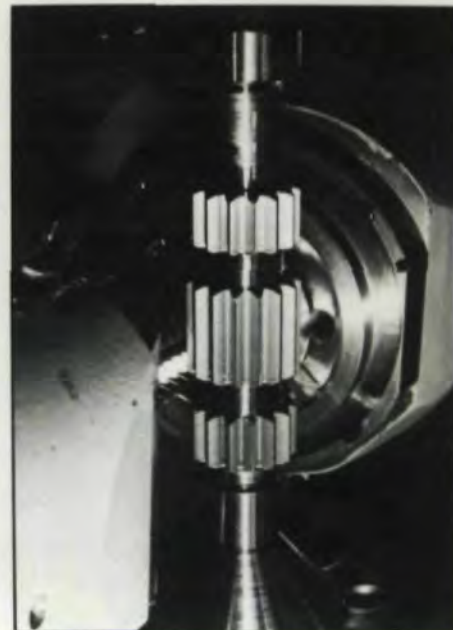

Fig. 5

hobs and/or milling cutters.

Loading and clamping the part only once represents a time saving and an increase in quality of the gears being machined. An additional effect can be obtained through the precise timing of one set of gear teeth to another.

An interesting example of this process is that of a planetary pinion used for controlling the flap actuation of aircraft. (Fig. 5) In this case, there are three gears

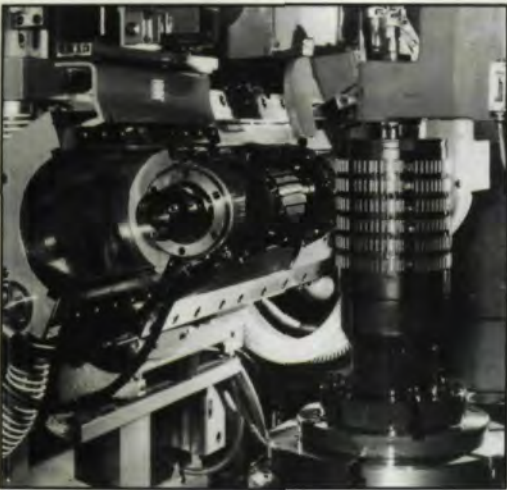

Fig. 6

on one pinion, each set of teeth timed to the others within close tolerances. In addition, these three gears have different crown and taper corrections in order to mesh correctly when under a load. The pinions are machined in one operation using one or two hobs, depending upon the design, and the time taken is less than four minutes.

A second application is a synchro gear for a truck reduction gear box. (Fig. 6) A gear is produced with a three-start hob, and, subsequently, nine slots are milled, these being positioned to the hob gear with unequal angles from slot to slot. These slots are machined with a milling cutter using indexible carbide inserts. In a similar application, a second milling cutter is removing particular teeth of the gear. With a stack of six gears, the total time taken for one gear is less than 1.5 minutes. Position of accuracy of teeth to slots is as close as 0.01 mm.

Another economical application for CNC hobbing machines is the skive hobbing of hardened gears. (Fig. 7) The closed-loop control for the work table rotation ensures high pitch and lead accuracy despite the remarkably high tangential forces in this process. NC technology enables fast automatic positioning of the pre-hobbed gear.

A worm with the same lead as the hob is mounted on the hob arbor. The worm can be moved axially against a spring in order to avoid collision between the worm and the gear.

By means of a separate NC sub-program, the gear first meshes with the worm. Through the use of synchronized shifting, the tangential slide is moved until the skive hob is in a position to cut. After clamping the gear, the machine



Fig. 7

center distance is compensated to allow for the necessary stock removal. This device is particularly suitable for small batches of gears with differing numbers of teeth, but with the same pitch. The advantages are that the worm has only to be adjusted once to the hob and can be applied to different gears. The whole process of positioning is automatically performed in no longer than 10 seconds.

Setup times (Fig. 8)

A conventional gear hobbing machine usually requires a time of 90 minutes for a full changeover including fixtures, tripdogs, hob swivel, etc.

With a three-axis NC machine this time can be reduced by approximately 20 minutes, as the setting of tripdogs and selecting the cycle and speeds and feeds are part of the NC program.

A drastic reduction is achieved when a quick change system is applied to both hob and fixture. (Fig. 9) The remaining axes of the machine are controlled by numerical control. For example, hob change can be reduced from 15 minutes to one minute, fixture change from 20 minutes (runout check and clamping) to less than five minutes.

Part of the set up can be carried out while the machine is working. This applies to the preparation of the next fix-

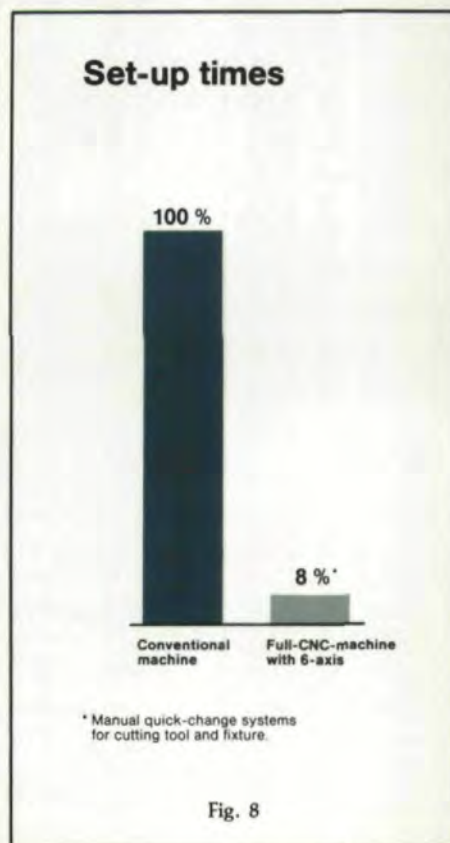

Fig. 8

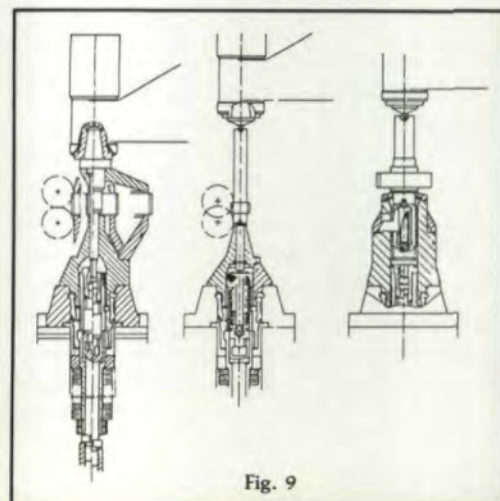

Fig. 9

ture, to the mounting of the next hob on a second arbor and to checking it for runout. (Fig. 10) Even machine offsets can be determined by measuring the hob prior to mounting it on the machine.

Gauging of the hob can be carried out either on an NC-tool setting machine or with a special measuring fixture which will check the hob effective diameter. With this fixture, runout and taper can also be checked. Checking the first part of a batch may become obsolete.

Further savings during set up time are achieved through the use of parallel programming; i.e., the machine can be programmed for the next part while it is in operation.

The question of whether or not fixture change and hob change should be automatic depends on the utilization of the machine. If the batches are small so that set up occurs at least once per shift, and the machine is being used over three shifts per day, an automatic change of both the fixture and hob can be justified economically. In other cases where batch sizes are larger, automatic hob change alone may be the economic solution. Manual change of the fixture takes a little longer, but as the changeover frequency is lower, this factor is really insignificant.

Uptime (Fig. 11)

Short cycle times and changeover

Fig. 10



The Hard Facts

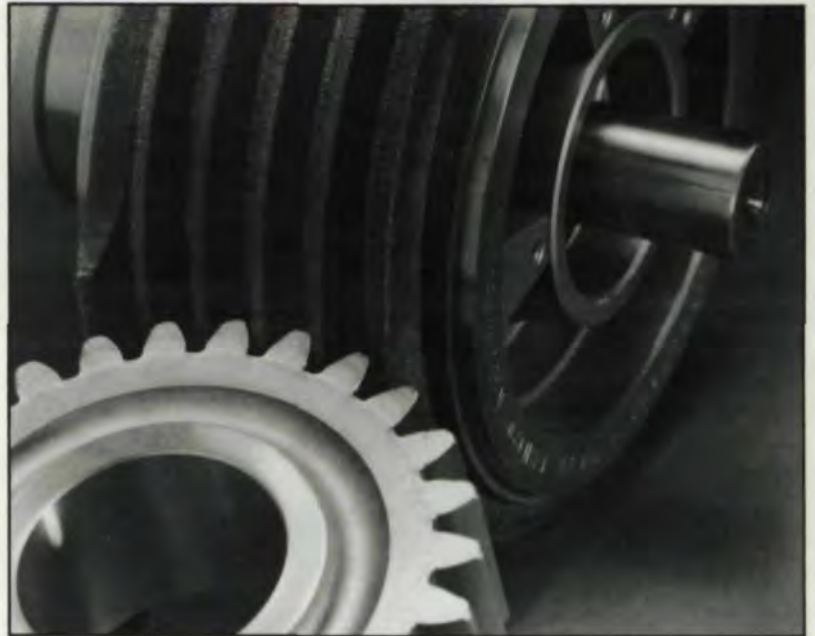

About Hard-Gear Finishing.

Hard-Gear Finishing is the best way to make precision gears for today's high speed and high load applications. The problem is, grinding hardened gears with conventional abrasives is slow, expensive, and produces tensile stress in the finished gear.

Electroplated Grinding Wheels by **DI-COAT** pit the cutting strength of **ABN 600*** against all your hard-finish applications. Our 16 years of experience in precision abrasive coating assures the finest superabrasive wheels available - the form you need for repeatable close-tolerance parts. Our ABN wheels even eliminate the cost of dressing.



DI-COAT leads the industry in superabrasive technology with form wheels, honing tools, mandrels, and reverse-plated dressing rolls. Call today for information on how we can meet *all* your abrasive needs.

DI-COAT
CORPORATION

*Technically Oriented
to your Superabrasive Needs.*

* **ABN 600** is a trademark of DeBeers Industrial Diamond Division.

(313)349-1211
42900 W. 9 Mile Rd.
Novi, MI 48050

Member:  

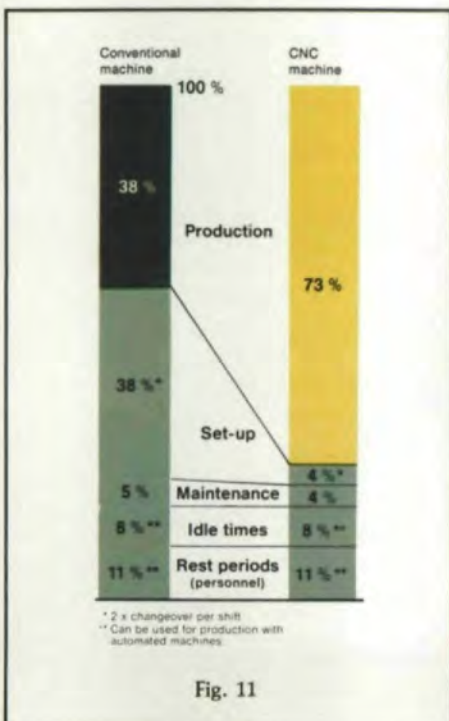
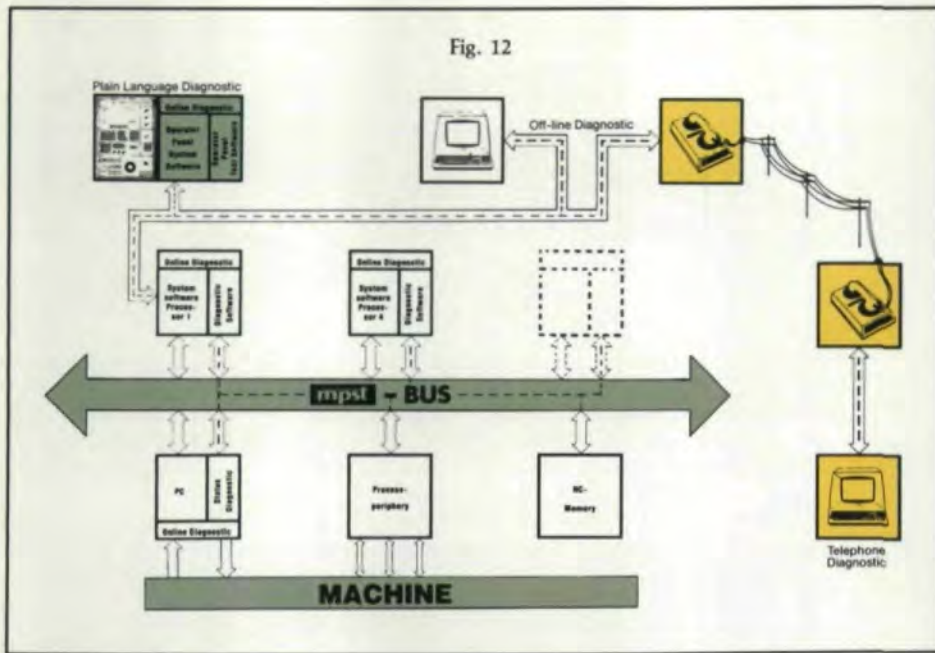

Fig. 11

CIRCLE A-10 ON READER REPLY CARD

March/April 1987 45



times are only effective if the machine is available for production; i.e., downtimes are at a minimum.

Minimum downtimes are maintained through a highly reliable machine and control system and the use of an operator-friendly diagnostic system, which assists in the maintenance of the machine. A modern CNC hobbing machine is equipped with a sophisticated diagnostic system, (Fig. 12) allowing approximately 80% of all maintenance to be carried out in-house.

Through the use of a modem and a normal telephone system, remote diagnosis of faults by a machine tool manufacturer can be of great assistance in trouble shooting.

Cost per piece (Fig. 13)

CNC techniques allow economical small batch production. A reduction in both cycle and set-up times makes CNC economically superior to the conventional machine, despite the higher investment involved.

Obviously, savings are larger with small batches, but with medium sized batches advantages are still shown.

In the above calculations, savings are achieved by means of the shorter throughput of a batch, because of combined operations and better tool utilization due to the ability to use partially used tools on subsequent batches. Another saving can be achieved through the ability to program any required cor-

rection to allow for subsequent shaving or heat treatment without added time, making shaving less expensive. In addition, with CNC machines, batch sizes and, thus, capital costs can be reduced.

The consequences of these considerations give the base for a model gear

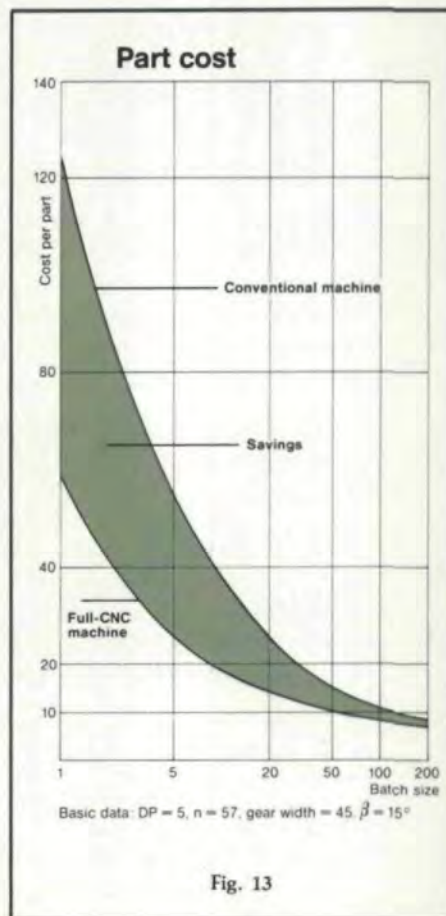

cutting center. It shows what can be realized today: a six axis full CNC hobbing machine serviced by a six axis CNC gantry automatic loader and a system designed for batch sizes of 1-200 in an unmanned three-shift operation. Economic justification has to be carried out individually, but in this example, calculations show that with 60 different parts and four machine changeovers per shift, this system can be justified.

Acknowledgement: This paper was presented at the SME "Gear Processing & Manufacturing Clinic," Nov. 1985.

THE EFFECT OF REVERSE HOBGING . . .

(continued from page 15)

bing with multi-threaded (4-, 5-threads), small diameter and TiN coated hobs be used for the low cost production of helical gears. Thus high speed steel hobs will be able to stand against severe cutting conditions such as cutting speeds of 100m/m and hob feed rates of 4-6 mm/rev.

References

1. AINOURA, M. et al, "A Research on High-Speed Hobbing With the Carbide Hob," ASME Transactions, Vol. 100, *Journal of Mechanical Design*, July, 1978, p. 478.
2. AINOURA, M. AND NAGANO, K., "A Recent Research on Hobs With High Efficiency and in High Speed," *Journess d'Etudes A LECAM*, Lyon, France, 1982.
3. AINOURA, M. AND NAGANO, K., "The Cutting Performance of TiN-Coated HSS Hobs by PVD Method," *Journess d'Etudes A LECAM*, Lyon, France, 1982.
4. AINOURA, M. AND NAGANO, K., "A Research on High-Speed Hobbing With High-Speed Steel Hob," ASME Paper No. 80-C2/DET-50, 1980.
5. AINOURA, M. AND NAGANO, K., "A Research on High-Speed Hobbing with High Speed Steel Hob - Parts 1 & 2," *Transactions, Japan Society of Mechanical Engineers*, Vol. 48, No. 436, 1982.
6. AINOURA, M. AND YONEKURA, M., "A Research on High-Speed-Precision Gear Hobbing With the Carbide Hob and Unique High-Speed Hobbing Machine," *World Congress on Gearing*, Vol. 2, Paris, France, 1977.

Acknowledgement: This article was previously presented at a 1984 ASME Conference. Paper No. 84-DET-147.

CLASSIFIED

Rates: Classified Display—\$100 per inch (minimum 3") Type will be set to advertiser's layout or *Gear Technology* will set type at no extra charge. **Word Count:** 35 characters per line, 7 lines per inch.

Payment: Full payment must accompany classified ads. Mail copy to *Gear Technology*, P.O. Box 1426, Elk Grove Village, IL 60007. **Agency Commission:** No agency commission on classifieds.

Closing date: Ads must be received by the 25th of the month, two months prior to publication. **Acceptance:** Publisher reserves the right to accept or reject classified advertisements at his discretion.

SUBCONTRACT WORK

Coniflex bevels up to 34" diameter.
Spirals & Straight Bevels up to 60" diameter.

Spurs & Helicals up to 120" diameter.

BREAKDOWN WORK IS OUR SPECIALTY!!

Complete machining, heat treat,
lapping & testing.

CALL US!

B & R
Machine & Gear Corporation



P.O. Box 536
Sharon, TN 38255
(901) 456-2636
1-800-238-0651

CIRCLE A-34 ON READER REPLY CARD

POSITION WANTED

POSITION WANTED

Service Engineer/Consultant. Forty-eight years prior experience at Gould & Eberhardt as service engineer. Available for consulting regarding service and parts for Gould & Eberhardt machinery.

Send inquires to:

Ed Jacobs
#8 Beau Monde Drive
North Hampton, NH 03862
(603) 964-7174

GEARS-SPLINES

DESIGN AND TOOLING

- Custom gear design including non-standard pressure angles for more strength.
- Programs to enter tooling data into computer files and search for existing cutters to cut a new gear or spline.
- Gearing computer software for sale.
- Consulting services for gear and spline problems.

VAN GERPEN-REECE ENGINEERING
1502 Grand Blvd.
Cedar Falls, Iowa 50613
(319) 266 4674

CIRCLE A-38 ON READER REPLY CARD

GEAR ESTIMATING

The **COSTIMATOR**[®] computer aided cost estimating system insures speed and consistency in the difficult task of estimating the costs of all types of gears.

Used by small shops and Fortune 500 companies throughout the country.

For complete information
contact us today.

Manufacturers Technologies, Inc.
27G Capital Drive
West Springfield, MA 01089
(413) 733-1972

CIRCLE A-29 ON READER REPLY CARD

There's still time . . .
closing date for a classified ad
in the May/June issue is
March 25th.

HELP WANTED

GEAR PERSONNEL

**ENGINEERS
GEAR GRINDERS
MACHINISTS
PRODUCTION CONTROL
QUALITY CONTROL/INSPECTION
SALES
SHOP SUPERVISION, ETC.**

If you are in the gear business in any capacity, are ambitious and thinking of making a move, send us your resume. The above and other new positions are being created by internal growth at both our San Diego, California & Roseville, Michigan plants.

ACR INDUSTRIES, INC.
29200 Calahan
Roseville, Michigan 48066

GEAR ENGINEER

Spur and helical production gear manufacturing company has opening for engineer and manager of engineering.

Ideal candidate will have experience in manufacturing, project and process engineering, as well as automation and state-of-the-art technology.

These positions are being created by internal growth.



Reef Gear Mfg., Inc.
50903 E. Russell
Schmidt Blvd.
Mt. Clemons, MI 48045

Bring in new customers
for your business by advertising in
GEAR TECHNOLOGY,
The Journal of Gear Manufacturing.
Call (312) 437-6604

APPRECIABLE INCREASES IN SURFACE . . .

(continued from page 41)

Abbott's bearing area curves for skived and mirror-like teeth are shifted upside down to indicate a maximum height of $2.96 \mu\text{m}$, the height of the highest top of the roughness curve of the conventionally ground teeth.

The radius of curvature at the tops of the roughness curve will closely relate to the surface durability of tooth surfaces. It is clear that the greater the generalized fullness ratio, the greater the radius of curvature at the tops of the roughness curve. For the sake of numerical understanding, the distributions of the radius of curvature at the tops of roughness curves are shown in Fig. 23 for teeth with three different surface finishes. The mean radius for the teeth with mirror-like finish is appreciably greater than the conventionally ground or skived teeth.

Conclusions

In order to know the beneficial effects which might be obtained from the mirror-like finishing of teeth, spur gears finished by four different methods were tested using a gear endurance testing machine with a hunting gear ratio. The results obtained are as follows:

(1) An appreciable increase in the surface durability was obtained when both the driver and follower were finished like a mirror with a roughness of about $0.1 \mu\text{m } R_{\text{max}}$ ($\pm 1.0 \mu\text{ in. } R_a$) using a new grinder with a CBN wheel.

(2) Tooth surfaces of teeth with mirror-like finishes were hardly deteriorated even after a loaded running of over 10×10^6 revolutions at a Hertzian pressure of about 1200 MPa.

(3) When only the tooth surfaces of the driver (harder gear) were finished like a mirror, the ones of the mating hobbled or skived gear were improved like a mirror because of running-in, and the surface durability increased appreciably.

(4) The reason why an appreciable increase in the surface durability is obtained when the gears with mirror-like finishes are used, was explained by the measurement of the duration of EHL conditions during loaded running.

Fig. 21—Changes in surface hardness of 300 HB gears.

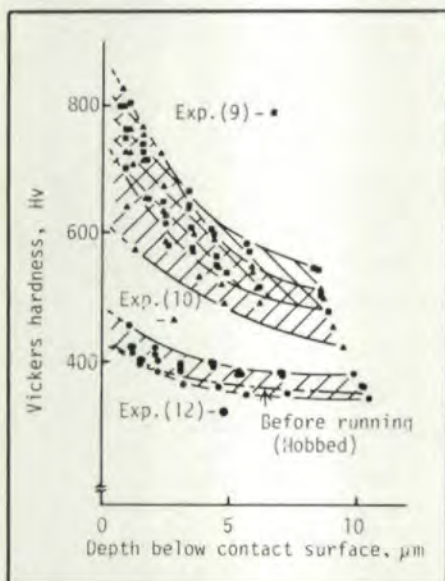

Fig. 22—Bearing area curves of tooth surface.

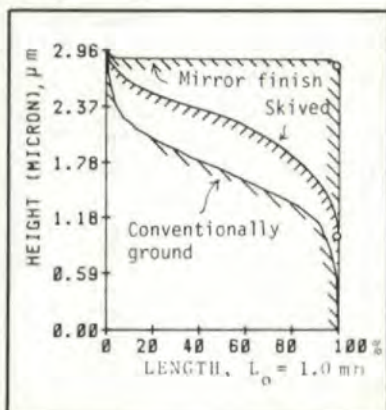
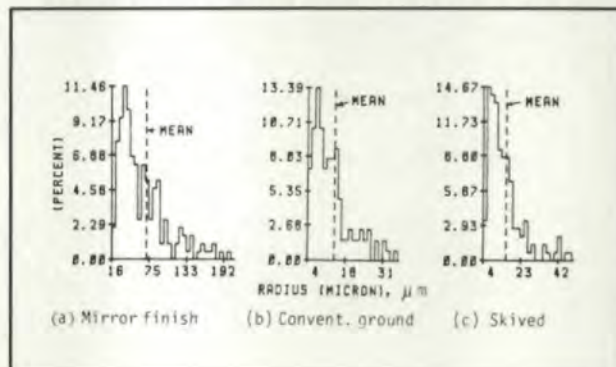

Fig. 23—Radii of curvature at the top of roughness curves.



(5) Moreover, this conclusion was supported by the measurement of micro-hardness at the contact surface after loaded running.

(6) The generalized fullness ratio of surface roughness curves was introduced to explain the beneficial effects obtained from the gears with mirror-like finishes as opposed to the gears with conventional surface finishes.

The authors express their thanks to Emeritus Professors A. Wakuri and T. Ueno, Kyushu University, for their encouragement. Thanks are also due to Mr. S. Hoyashita and the staff of Machine Shop of the Faculty of Science and Engineering, Saga University, for their assistance in making this investigation.

This article was previously presented during a 1984 ASME technical conference. Paper No. 84-DET-223.

References

1. ISHIBASHI, A., "Surface Roughness and Surface Durability of Gears", *Jour. Japan Soc. Lub. Engrs.*, Vol. 19, No. 2, Feb. 1974, p. 146-154, (in Japanese).
2. ISHIBASHI, A., EZOE, S., and TANAKA, S., "Mirror Finishing of Tooth Surfaces Using a Trial Made Gear Grinder with Cubic-Boron-Nitride Wheel", to be presented at the Fourth International Power Transmission and Gearing Conference (Oct. 1984, Cambridge, Massachusetts).
3. ISHIBASHI, T., *Prevention of Fracture and Fatigue of Metals*, Yoken-do, Tokyo, 1967, p. 337, (in Japanese).
4. ISHIBASHI, A., and YOKOTE, T., "Mechanism of Pitting on Rolling Contact Surfaces", Preprint of Japan Soc. Mech. Engrs., No. 700-18, Oct. 1970, p. 69-72, (in Japanese).
5. ISHIBASHI, A., and TANAKA, S., "Effects of Hunting Gear Ratio Upon Surface Durability of Gear Teeth", *Trans. ASME, Jour. Mech. Design*, Vol. 103, No. 4, Jan. 1981, p. 227-235.
6. TANAKA, S., and ISHIBASHI, A., "Effects of Errors and Gear Ratios upon Surface Durability of Spur Gears", *Proc. International Symposium on Gearing and Power Transmission*, Vol. 1, Sept. 1981, p. 383-388.
7. ISHIBASHI, A., et al., "Effects of MoS₂ Particles in Oil on the Pitting of Rolling/Sliding Contact Surfaces under Nearly Full EHL Conditions", *Proc. 5th Leads—Lyon Symposium on Tribology*, Sept. 1978, p. 282-287.
8. WAKURI, A., KIMURA, K., and AINOURA, M., "Study on Skiving Hobs", Preprint of Japan Soc. Mech. Engrs., No. 730-10, July 1973, p. 55-62, (in Japanese).
9. DOWSON, D., "Elastohydrodynamic", *Proc. Conf. Lubr. and Wear*, Paper 10, Inst. Mech. Engrs., London, 1967.
10. ISHIBASHI, A., and HOYASHITA, S., "Appreciable Increase in Pitting Limit of Steel and Bronze", *Tribology International*, Vol. 15, No. 6, Dec. 1982, p. 349-356.
11. ISHIBASHI, A., and HOYASHITA, S., "Remarkable Effects of Running-in upon Surface Durability of Steel and Bronze", *Tribology International*, Vol. 15, No. 6, Dec. 1982, p. 357-365.
12. YAMAMOTO, K., *Surface Roughness*, Corona Pub. Co., Tokyo, 1974, p. 26, (in Japanese).

THE INNOVATIVE "SILENT SHAFT" GEAR SHAPER CUTS CYCLE TIME TO 1/2!

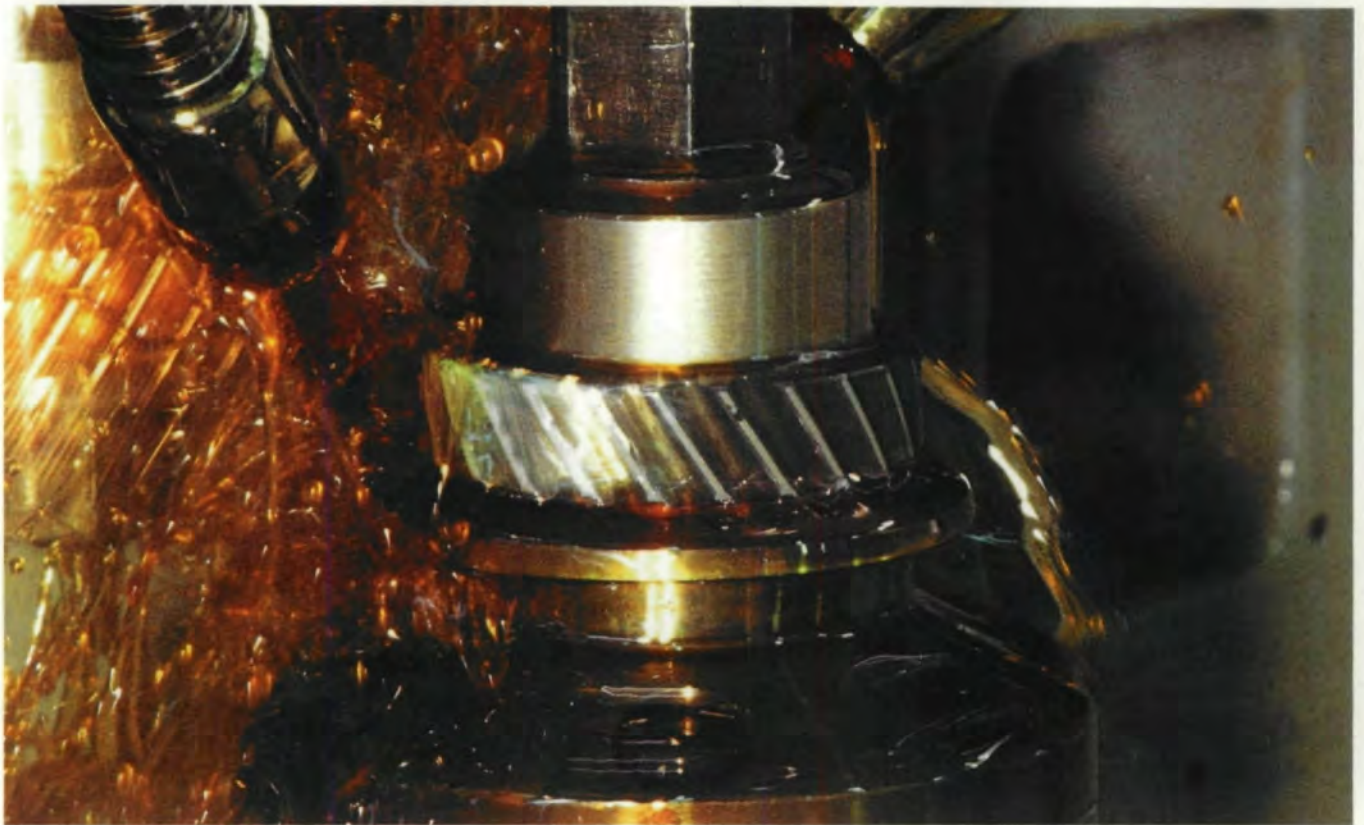

Mitsubishi has developed a new "silent shaft" mechanism that overcomes the vibrations encountered in high speed operations of gear shaping and lets you cut the cycle time in half. Two silent shafts rotating together with the crankshaft, cancels vibration on the SA25NC Gear Shaping Machine. This innovative mechanism permits speeds as high as 1,500 strokes per minute ... yet the vibration is one third of conventional machines.

Another feature of the SA25NC is the high rotary feed. The combination of the two features enables you to cut gears faster maintaining high accuracy and gives longer tool life to the cutter. Simplified programming, reduced setup times and



many, many more features to save you money. For more exciting information, contact our sales office in Bensenville, Illinois now!

Main Specifications

Max. dia. of work	
External gear	10" (4" cutter)
Internal gear	4.72" + cutter dia.
Max. D.P.	4DP
Max. work width	2.36"
Cutter stroke	300 ~ 1500str/min
Rotary feed (4" cutter)	0.0004"/str (at 300 str/min) 0.00008"/str (at 1500 str/min) 0.11 ~ 177.16 ipm
Table dia.	13"
Main motor power	7.5hp
Machine weight	11,000 lb.

CNC GEAR SHAPER



**MITSUBISHI
HEAVY INDUSTRIES, LTD.**

5-1, Marunouchi 2-chome, Chiyoda-ku, Tokyo, Japan
Cable Address: HISHIJU TOKYO

Mitsubishi Heavy Industries America, Inc.

873 Supreme Drive, Bensenville, IL 60106 Phone: (312) 860-4220

Mitsubishi International Corporation

873 Supreme Drive, Bensenville, IL 60106 Phone: (312) 860-4222

CIRCLE A-8 ON READER REPLY CARD



How to tell a troublemaker from the strong silent type

With G-AGE™, the complete line of gear testing and measurement equipment and programs

Some of the nicest looking gears start whining and grumbling as soon as they're put to work. And that's one kind of trouble you want to stop before it starts. You can — easily and efficiently — with G-AGE test and measurement products from Gleason.

G-AGE is the most complete gear-inspection line of its kind in the world. If you make or use bevel, hypoid, or helical gears, there's a G-AGE product for you. One that will tell you exactly what you need to know for effective QA/QC at incoming inspection or at any stage in gear manufacturing.

The G-AGE line includes:

- Rolling contact checkers for your expert inspectors.
- A full range of elemental testers to check tooth position and geometry or shape.
- Programs for coordinate measuring to determine tooth form errors based on design data and to provide corrective machine settings.
- Sophisticated single-flank testing systems that let you investigate transmission error and most related parameters of a gear or gear pair.
- The ultimate gear QC system — the

GLEASON

Advanced concepts, traditional quality. That's the new Gleason.

579 Automatic Data Analysis System. Interfaced with any G-AGE single-flank tester, it automatically interprets test data to give you more answers, in more usable form, than any other system.

G-AGE is your key to higher quality gears, less scrap, lower costs, and a greater degree of control than ever before possible.

Nobody knows more about gears and gear testing than Gleason. Let us help you select the G-AGE equipment or program you need to eliminate potential troublemakers before they can start a rumble. Call 716-473-1000 or write Gleason Works, 1000 University Avenue, Rochester, NY 14692, U.S.A.