

# GEAR TECHNOLOGY

JULY/AUGUST 2001

The Journal of Gear Manufacturing

[www.geartechnology.com](http://www.geartechnology.com)

## FEATURES

- GEAR-CUTTING TOOL MATERIALS
- OPTIMIZING HYPOID STOCK DISTRIBUTION
- MEASURING BASE HELIX ERROR ON A SINE BAR

## GEAR EXPO PRE-SHOW ISSUE

- GEAR EXPO BASICS
- EXPO EXPECTATIONS
- WHY YOU SHOULD GO TO GEAR EXPO

### GEAR EXPO 2001



**THE GEAR INDUSTRY'S INFORMATION SOURCE**

*Gleason-Pfauter...*

# ***THE BIGGEST NAME***

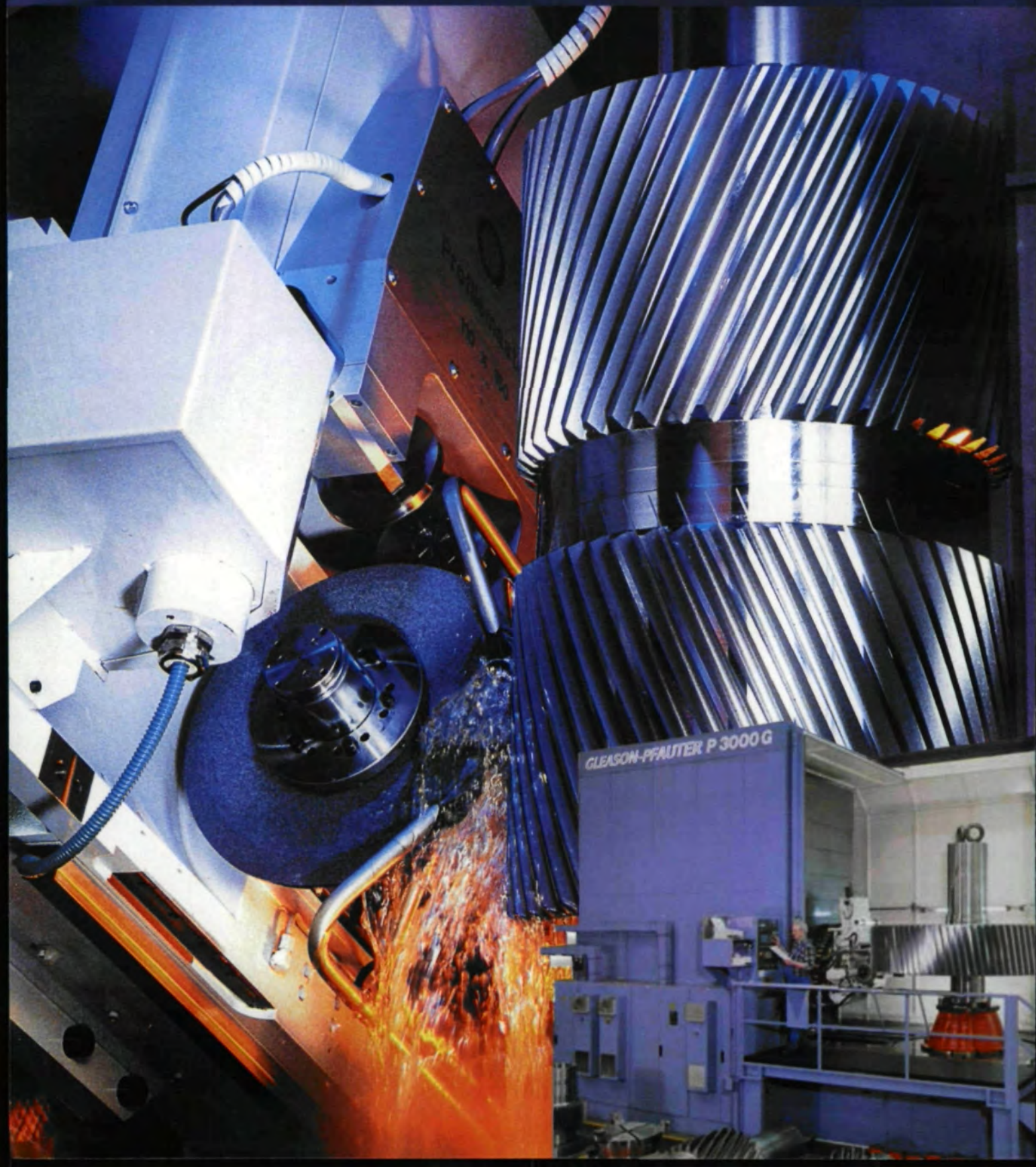

# IN PROFILE GRINDING



**From 400 to 4,000 mm:  
the Gleason-Pfauter  
Profile Grinders  
deliver higher  
accuracy, greater  
efficiency; and  
reduce costly  
non-productive  
time.**

Today's gear applications demand hard-processed precision far in excess of what was required only a few years ago. Achieving higher quality usually requires more time—and cost.

Only the Gleason-Pfauter product line gives you the best of both worlds: the highest levels of gear accuracy, combined with unprecedented machine performance. Precious non-productive time is greatly reduced. Here's how:

- Fully automated in-process gear inspection software completely analyses stock distribution, even taking into account heat treat distortion. The program then establishes an optimized production cycle. The need for off-line inspection before and after grinding is totally eliminated.
- On-machine dressing is perfected with parameters selected through



*Fully automated in-process gear inspection software analyzes stock distribution, optimizes the production cycle, and eliminates the need for off-line inspection. Shown above: measuring results on the lead (after production).*

years of experience. Grinding with Gleason high-precision plated CBN wheels is also possible. Both vitrified and CBN wheels can be used for grinding internal and external gears, thus offering maximum flexibility.

- A Windows® user interface, with the latest Siemens CNC technology, results in an operator-friendly environment with simple data input to a sophisticated process technology software platform.
- After all, Gleason-Pfauter pioneered form grinding for large gears. The bigger the gears, the better Gleason looks. Call us today. We'll cut your big gear challenge down to size.



## The Gleason Works

1000 University Ave., P.O. Box 22970  
Rochester, NY 14607-1282 U.S.A.  
Phone: 716/473-1000 Fax: 716/461-4348  
Web site: [www.gleason.com](http://www.gleason.com)

CIRCLE 110

NOW AVAILABLE FROM  
STAR CUTTER COMPANY

SHAPER CUTTER  
RESHARPENING IS NOW  
AVAILABLE AT STAR CUTTER!

# Star Resharpener

Star Resharpener for Hobs and Form Relieved Milling Cutters... from a Leading Manufacturer of Hobs and Form Relieved Milling Cutters and Tool Grinding Machines. And now Shaper Cutter Resharpener is available at Star Cutter... The Number One Choice for Resharpener Services.



[www.starcutter.com](http://www.starcutter.com)  
email: [resharp@starcutter.com](mailto:resharp@starcutter.com)

Phone: 1-888-Resharp  
Fax: 1-989-345-5660

SIGMA  POOL



Since 1927

**Star**<sup>®</sup>

STAR CUTTER COMPANY

West Branch Industries.

A subsidiary of Star Cutter Company.  
2083 M55, West Branch Michigan, 48661  
Telephone Toll Free 888-RESHARP  
Fax 517-345-5660

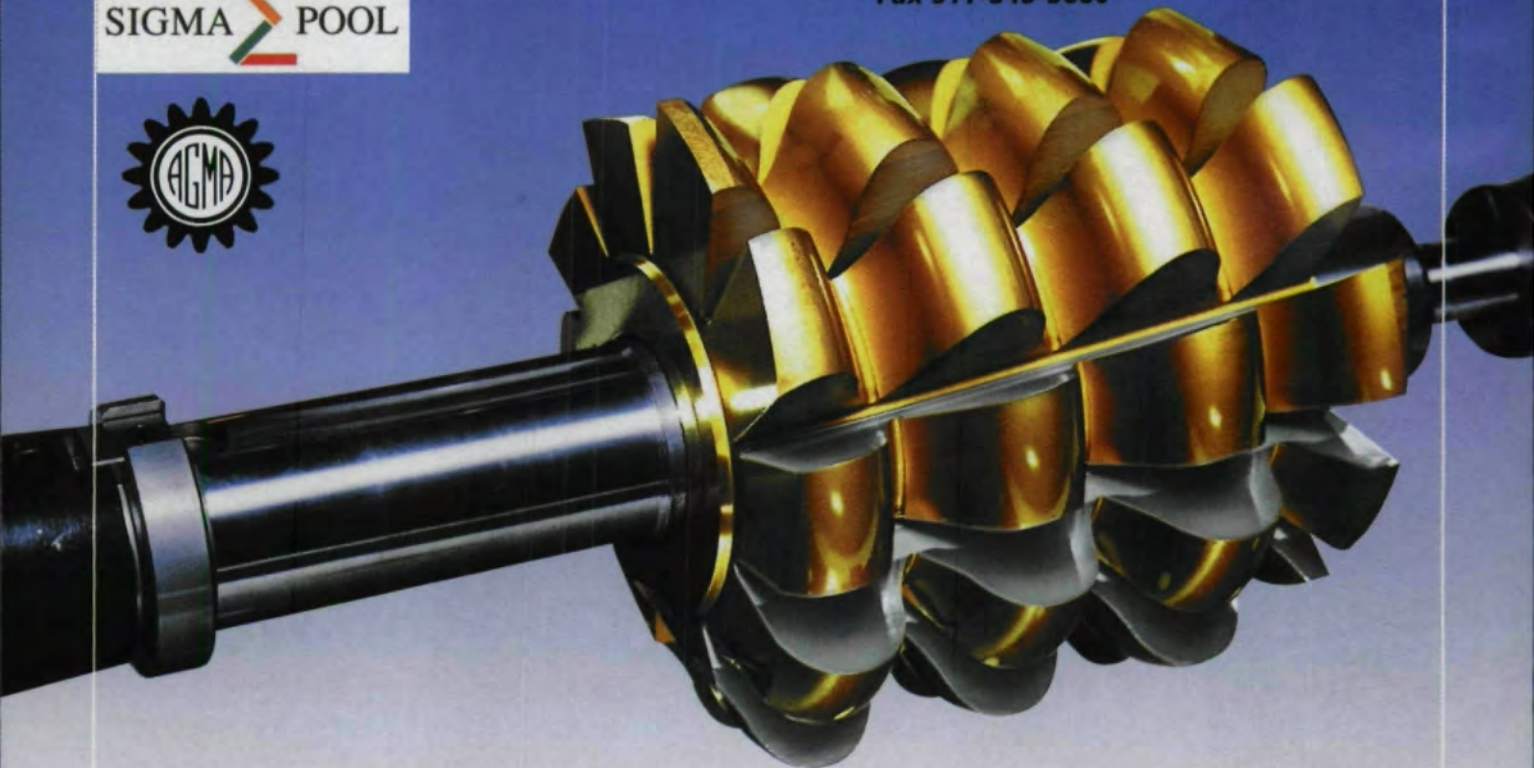

VISIT US AT GEAR EXPO BOOTH #536.

CIRCLE 132

# GEAR TECHNOLOGY

JULY/AUGUST 2001

The Journal of Gear Manufacturing

## FEATURES



25

### Material Properties and Performance Considerations for High-Speed Steel Gear-Cutting Tools

Differences in high-speed steels affect gear-cutting tool performance.....17

### Measuring Base Helix Error on a Sine Bar

Using simple tools to measure base helix instead of lead and profile.....25

### Stock Distribution Optimization in Fixed Setting Hypoid Pinions

An algorithm to optimize stock distribution between roughing and finishing.....34

## GEAR EXPO 2001 SPECIAL SECTION



41

**Gear Expo Pre-Show Coverage**.....41

### Gear Expo and Fall Technical Meeting—Together Again!

Basic information on Gear Expo 2001.....42

### Great Expotations?

Exhibitors and attendees share their expo expectations.....45

### Product Preview

Special advertising section featuring products from Gear Expo exhibitors.....49

## DEPARTMENTS

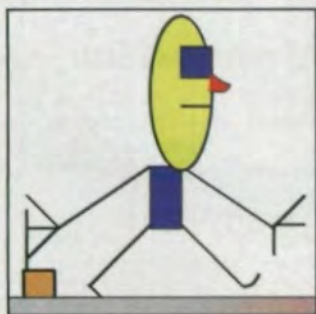

11

### Publisher's Page

Eyes on Detroit: Why YOU should go to Gear Expo.....9

### Revolutions

A new coating for cutting tools, a machine that cuts and tests large spiral bevel gears.....11

### Technical Calendar

Don't miss these important upcoming events.....24

### Industry News

New hires reshape the gear industry.....31

### Advertiser Index

Get information from advertisers by using the response card or going online.....33

### Product News

The latest products for the gear industry.....51

### Webfinder Mart

Visit these important gear-industry websites.....53

### Classifieds

Services, Help Wanted and more.....54

### Addendum

aMAZEing Gear Design.....56



56



# BARIT INTERNATIONAL CORPORATION

**Prompt, Personalized Service!**

### Custom Tools

- Hobs .8-50 DP
- Shaper Cutters
- Milling Cutters
- Shaving Cutters
- Broaches

### Stock Items DP and MOD

- Hobs, 1DP and finer
- Shaper Cutters



3384 COMMERCIAL AVE. • NORTHBROOK, IL 60062 USA  
 TEL: 847-272-8128 • FAX: 847-272-8210  
 Website: [www.barit.com](http://www.barit.com) • E-mail: [people@barit.com](mailto:people@barit.com)

VISIT US AT GEAR EXPO BOOTH #372.

CIRCLE 136



## LeCOUNT EXPANDING MANDRELS

**WANTED?**  
**MORE ACCURACY**  
**MORE EXPANSION**  
**MORE VERSATILITY**  
**LONGER LIFE**  
**AND LESS COST?**



**THE ANSWER FOR 150 YEARS.**

### LeCOUNT, Inc.

12 Dewitt Dr. • PO Box 950 • White River Jct., VT 05001 U.S.A.

Tel: (800) 642-6713 or (802) 296-2200 • Fax: (802) 296-6843 E-mail: [lecount@sover.net](mailto:lecount@sover.net)

Website: <http://www.lecount.com> (includes product specifications)

VISIT US AT GEAR EXPO BOOTH #143.

CIRCLE 141

## GEAR TECHNOLOGY

*The Journal of Gear Manufacturing*

### EDITORIAL

**Publisher & Editor-in-Chief**  
Michael Goldstein

**Managing Editor** William R. Stott

**Associate Editor** Joseph L. Hazelton

**Editorial Consultant** Paul R. Goldstein

### Technical Editors

Robert Errichello  
Don McVittie  
Robert E. Smith  
Dan Thurman

### ART

**Art Director** Jean Bartz

### ADVERTISING

**Advertising Manager** Patricia Flam

**Advertising Coordinator** Susan Brandt

### CIRCULATION

**Circulation Coordinator** Dina Krauss

### INTERNET

**Internet Editor** Dan MacKenzie

**Gear Industry Home Page™ Sales**  
Patricia Flam

**powertransmission.com™ Sales**  
Robert Poll

### RANDALL PUBLISHING STAFF

**President** Michael Goldstein  
**Vice President** Richard Goldstein  
**Controller** Michael Grafman  
**Accounting** Mary Lou Napadow

Phone: 847-437-6604

E-mail: [people@geartechnology.com](mailto:people@geartechnology.com)

Web: [www.geartechnology.com](http://www.geartechnology.com)

[www.powertransmission.com](http://www.powertransmission.com)



**VOL. 18, NO. 4**

GEAR TECHNOLOGY, The Journal of Gear Manufacturing (ISSN 0743-6858) is published bimonthly by Randall Publishing, Inc., 1425 Lunt Avenue, P.O. Box 1426, Elk Grove Village, IL 60007, (847) 437-6604. Cover price \$5.00 U.S. Periodical postage paid at Arlington Heights, IL, and at additional mailing office. Randall Publishing makes every effort to ensure that the processes described in GEAR TECHNOLOGY conform to sound engineering practice. Neither the authors nor the publisher can be held responsible for injuries sustained while following the procedures described. Postmaster: Send address changes to GEAR TECHNOLOGY, The Journal of Gear Manufacturing, 1425 Lunt Avenue, P.O. Box 1426, Elk Grove Village, IL, 60007. ©Contents copyrighted by RANDALL PUBLISHING, INC., 2001. No part of this publication may be reproduced or transmitted in any form or by any means, electronic or mechanical, including photocopying, recording, or by any information storage and retrieval system, without permission in writing from the publisher. Contents of ads are subject to Publisher's approval.



**NACHI**



NACHI MACHINING TECHNOLOGY CO.

# Global Expertise For All Applications

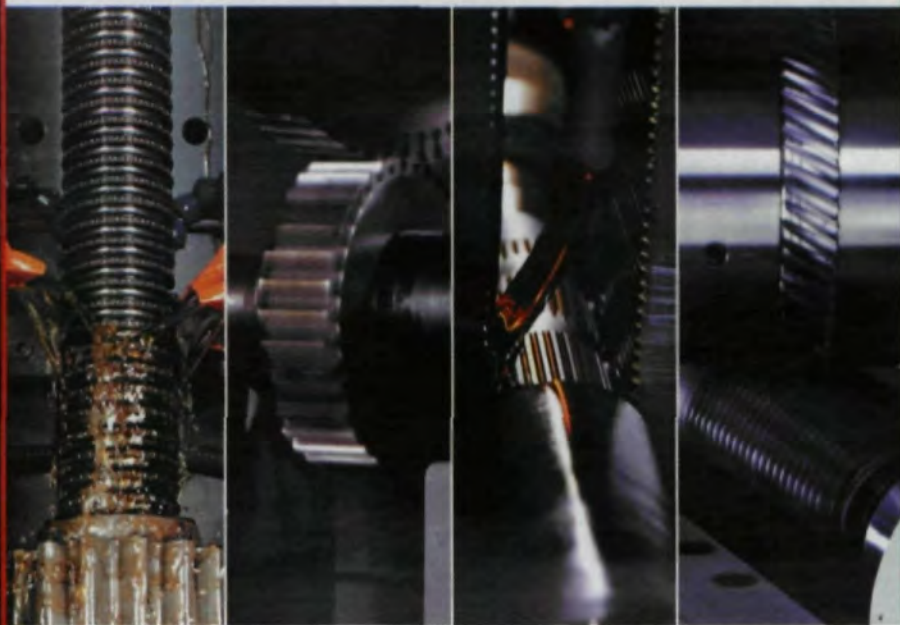

with continued leadership...

Combining over 140 years of process, machine, and tool experience enables Nachi Machining Technology Co. to maintain industry leadership by providing customers with the "best practices" manufacturing solutions.

For the finest products, performance, service, and global support...you can rely on NachiMTC to meet your application need today and tomorrow.

### **Broach and Gear Finishing Products**

#### *Broaching*

- Vertical*
- Horizontal*
- Pot*
- Surface*
- Blind Spline*
- Vertical Work Transfer*

#### *Gear Shaving*

#### *Roll Forming*

#### *Roll Finishing*

#### *Hobbing*

#### *Tool Sharpening*

#### *Honing*

#### *Gear Inspection*

#### *Form Grinding*



**NACHI MACHINING TECHNOLOGY CO.**

17500 Twenty-Three Mile Road, Macomb, Michigan 48044-1103  
Phone: (810)-263-0100 Fax: (810)-263-4571 [www.nachimtc.com](http://www.nachimtc.com)

# MAKING BIG



**NILES** builds gear grinding machines for the wind industry, ship transmission builders, heavy equipment manufacturers and the train propulsion business. Let us build one for you.



# THINGS MOVE

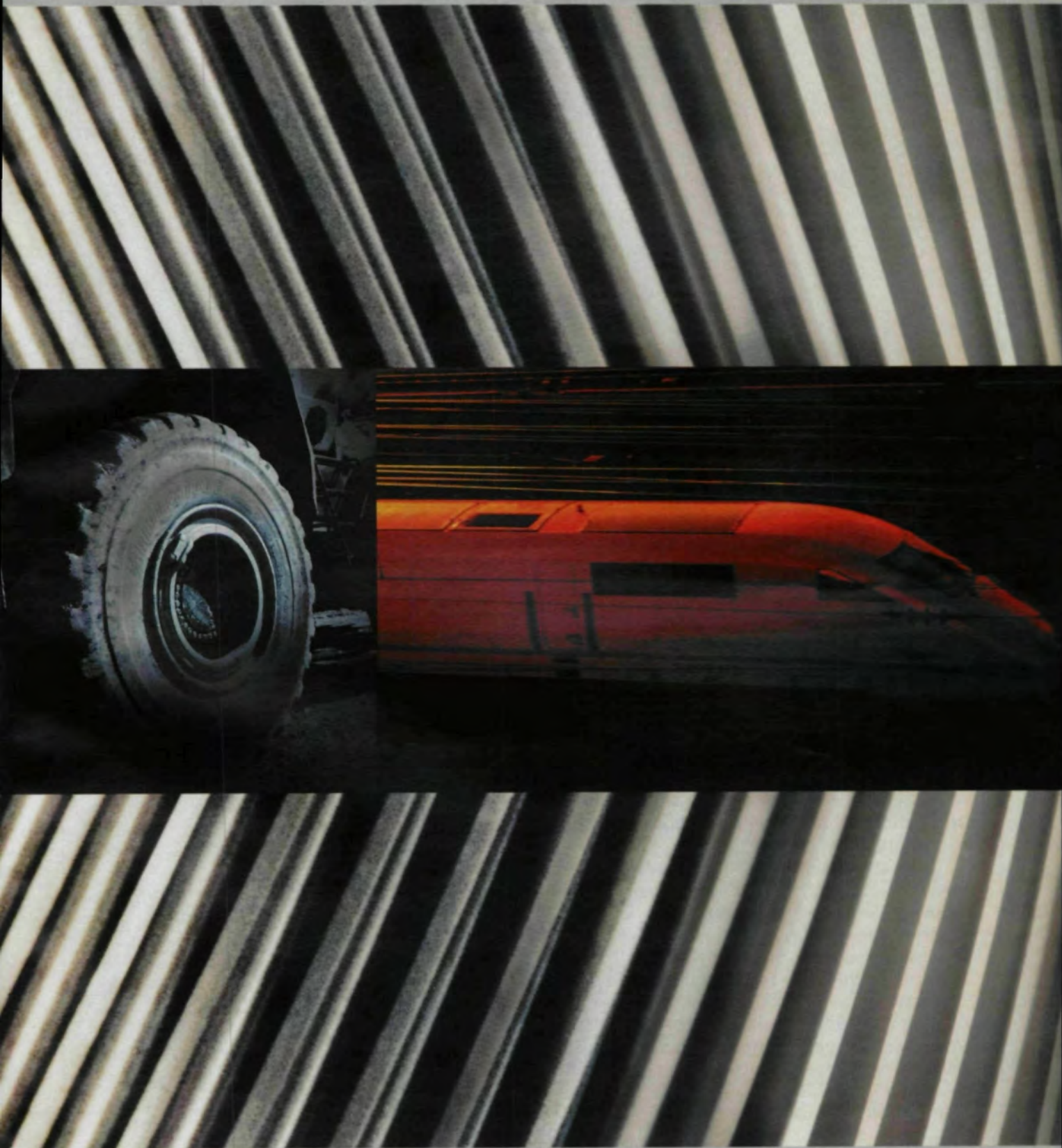

KAPP Technologies · 2870 Wilderness Place · Boulder, CO 80301, U.S.A.

Phone +1 (303) 938-9737 · Fax +1 (303) 447 1131 · [www.kapp-usa.com](http://www.kapp-usa.com)

CIRCLE 194

 **KAPP**  
G R O U P



## Quieter Gears. Engineered Metals.

There's only one way to ensure that the gears you produce will always deliver superior and quiet performance. Make sure they're bred from quality stock.

Dura-Bar® continuous-cast gray and ductile iron performs like free-machining steel with an important added bonus – quieter operation.

Like steel, Dura-Bar can be austempered, through-hardened, flame-hardened, or induction-hardened for added wear resistance. But the superior noise and vibration damping characteristics of Dura-Bar make for quieter running gears. And Dura-Bar is 10% lighter than steel.

Dura-Bar round bars are available in diameters ranging from 5/8" to 20" and lengths of 6-20'. So you won't need to make major changes in your machining equipment. And our extensive inventory means Dura-Bar is available now – when you need it.

When it's quality material, quiet performance, and quick delivery that count, look to continuous-cast Dura-Bar for your gear production needs.

 **DURA-BAR®**  
Continuous Cast Iron Bar Stock

Contact us for the latest data on gear noise.

1-800-BAR-MILL (227-6455) • 815-338-7800 • Fax: 815-338-1549  
2100 West Lake Shore Drive, Woodstock, IL 60098-7497  
Web Site: [www.dura-bar.com](http://www.dura-bar.com) • E-mail: [sales@dura-bar.com](mailto:sales@dura-bar.com)





# Eyes on Detroit

**If** you think of Gear Expo as only a machine tool show, you're not seeing all of its potential. You may be tempted to skip it this year, especially if you're struggling to fill your current capacity. I've heard too many stories of canceled orders, falling profits and slashed budgets to believe that great numbers of you will be attending Gear Expo with buying new machines as your No. 1 priority.

But for those of you who manufacture gears, buying machines *will* be your No. 1 priority someday, and learning about the latest technology now could prepare you for your buying decision in the future. Understanding how that technology can make you more productive or more competitive might even make it easier to justify the decision.

The place for learning about that technology is Gear Expo. This show offers too much valuable information for you to miss it, and this opportunity comes along only once every two years. Nowhere else in the world can you pick the brains of so many gear experts—and they include more than salespeople. The experts include the engineers who design the equipment, the technicians who install it and the service people who keep it running.

Also, we've heard that several machine tool manufacturers intend to introduce new technologies at this show.

Even if you don't manufacture gears, Gear Expo is an important event. It's not like EASTEC, WESTEC or IMTS. Those are machine tool shows. Gear Expo is the only event that includes all parts of the gear industry.

For example, there are more than 50 gear manufacturers scheduled to exhibit at Gear Expo. This show offers valuable information for both gear buyers and gear makers. So, if a significant part of your business involves designing, specifying or buying gears, then come to Detroit to learn about the product lines and manufacturing capabilities of many of the world's leading gear manufacturers.

AGMA is expecting somewhere around 200 exhibitors, which would make this Gear Expo the largest ever by far. Besides machine tool suppliers and gear manufacturers,

Gear Expo is home to exhibitors specializing in gear materials, cutting tools, workholding, heat treating services and coating services.

But the exhibitors aren't the only ones you can learn from at Gear Expo. The show also offers several educational opportunities, including the basic course from the AGMA Training School for Gear Manufacturing and four gear-related seminars conducted by SME.

To put it simply, there's nowhere else you can go to get so much current information on the gear industry. I urge you to attend Gear Expo and learn as much as you can.

My father used to say: "You don't know what you don't know." I've always thought that bit of wisdom was especially telling. If you skip Gear Expo, you won't be exposed to the information that's available there. More importantly, you won't know what you've missed out on. Maybe not knowing won't hurt you. But I can guarantee that some of your competitors *will* be at the show. Do you want *them* to know what you don't know?



*P.S.—Stop by our booth, #418, to say bello and for a chance to win a one-of-a-kind gear clock, which you can see on page 46!*

Michael Goldstein, Publisher and Editor-in-Chief

# Old Reliable Just Got Better



New Micro-top



New Sigma 3

## Prices starting at \$89,900

- Lowest price full capability gear inspection system.
- Compact, portable and shop-hardened.
- Reliable four-axis accuracy.
- Proven, Windows® based M&M software.

## The ultimate in inspection performance

- 3D probe measures all three axes at the same time.
- Linear motor direct drives for higher speed and unsurpassed repeatability.
- Four-axis generative motion provides optimal accuracy.
- Windows® based software — ideal for all types of gears and gear cutting tools.

**M&M** PRECISION  
SYSTEMS  
CORPORATION  
"THE METROLOGY & MOTION PEOPLE"®

Learn how Micro-top and Sigma 3 systems meet your requirements. Call 937/859-8273 or visit [www.mmprecision.com](http://www.mmprecision.com).

## Mobile Molecules

When titanium nitride (TiN) was introduced as a coating for cutting tools, the manufacturing world changed forever. The productivity gains of that and similar coatings have been so profound that coated hobs and other cutting tools are now the standard.

So where does a gear manufacturer look for the next revolution in productivity gains? At least one Chicago gear manufacturer thinks that coatings may be the answer yet again.

"We call it the magic coating," says

Yefim Kotlyar, gear technology and processing manager at Bodine Electric Co., a manufacturer of precision gears for its own fractional horsepower gearmotors, as well as for the open market.

The "magic" coating is an invisible, organic coating called SL, developed by SurfaceTech Inc. of Glenview, IL. Bodine has tested it on hobs and one worm disc cutter, with results of 150-300% improvement in gear cutting tool life compared with tools coated only with TiN. In Bodine's tests, the SL coating was applied on top of TiN.

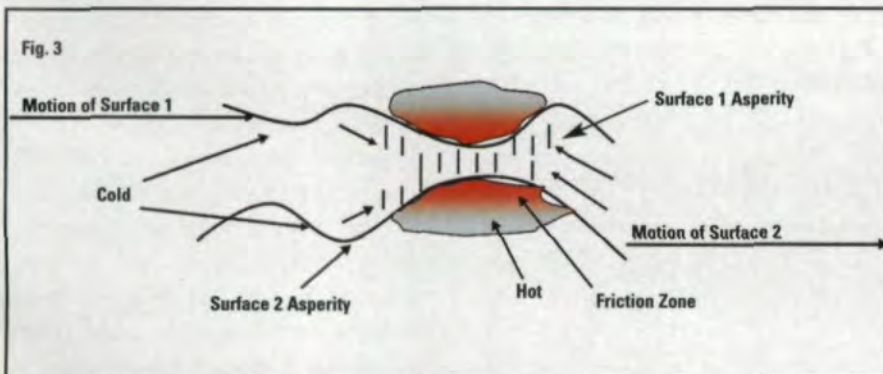
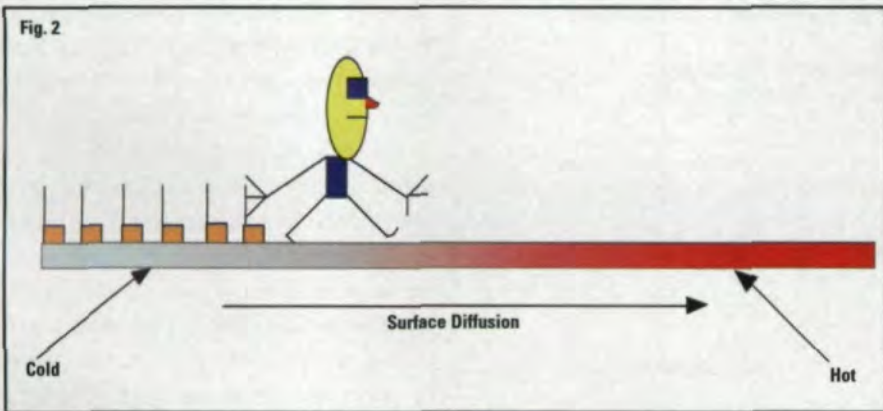
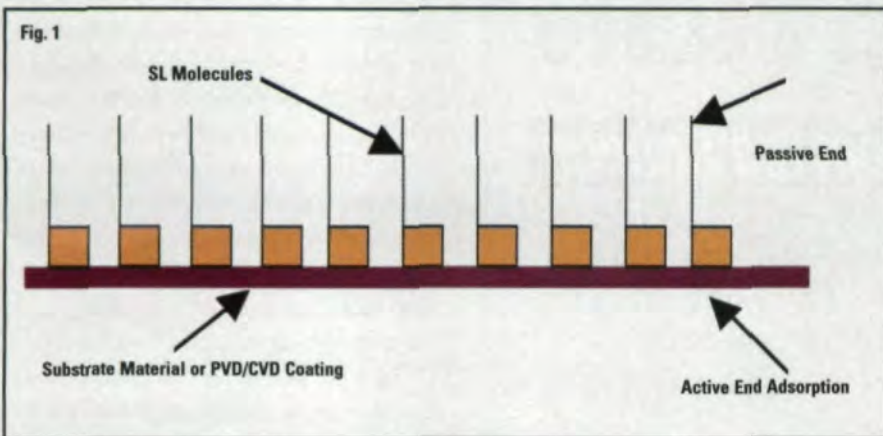

Molecules in the SL Coating from SurfaceTech Inc. move toward the hot spots.

*Welcome to Revolutions, the column that brings you the latest, most up-to-date and easy-to-read information about the people and technology of the gear industry. Revolutions welcomes your submissions. Please send them to Gear Technology, P.O. Box 1426, Elk Grove Village, IL 60009, fax (847) 437-6618 or e-mail [people@geartechnology.com](mailto:people@geartechnology.com). If you'd like more information about any of the articles that appear, please circle the appropriate number on the Reader Service Card.*

For example, one of Bodine's hobs (34 NDP, 20° NPA, 0.75" OD) cut 750 gears when coated with TiN. When the SL coating was applied on top of the TiN, the hob cut 1,500 gears, after which the test was stopped due to the order being filled. "The hob could produce more gears," Kotlyar says.

The SL coating works because it has a very unusual property: Its molecules move toward heat, providing protection to the areas that need it most, says SurfaceTech president Victor Aronov.

The mobile film coating is made up of long molecules known as radicals. One end of each molecule is positively charged, while the opposite end is neutral. When one of these radicals is brought close to a solid surface, it attaches itself (adsorbs) to the surface by its positively charged end. The neutral end, which is chemically passive, faces outside (Fig. 1). The sides of the adsorbed molecules interact with each other only weakly, so the film formed on the surface is not solid, and molecules may move freely. Since the outside ends of the adsorbed molecules are not chemically

active, the SL molecules cannot attach themselves to the workpiece surface. Thus, the molecular interaction between two contacting surfaces is diminished.

That causes considerable decrease in friction and material transfer from workpiece to cutting tool (built-up edge). The inactive end of the adsorbed molecules prohibits formation of a multilayered coating. Thus, the film thickness is restricted to the length of just one

molecule, about 30 angstroms, which does not significantly change the cutting tool geometry.

The molecules move, or diffuse, toward hot spots on a surface (Fig. 2). Because cutting tool surfaces are not smooth at the microscopic level, only the high points of the surface actually come in contact with the workpiece. During the cutting action, these high points become hotter faster. The SL molecules move

toward the hot spots, preventing direct solid-to-solid contact and providing extra lubrication where it is needed (Fig. 3).

SL is also unusual for a cutting tool coating because it's organic. "An organic coating that works for cutting tools is really an amazing thing," says Aronov. He adds that the perception has been that pressures and temperatures are too high in cutting tool applications for organic coatings. However, according to Aronov, the SL coating is stable up to 750°F.

The coating is applied by a simple dipping process, followed by a sophisticated thermal treatment. The thermal treatment is at less than 300°F, so the surface and substrate materials are unaffected, Aronov says, and its cost is compatible with prices for TiN or TiCN coating.

The SL coating has been applied and tested on a variety of cutting tools, including ceramic inserts and carbide cutting tools, Aronov says. In addition to Bodine Electric, SurfaceTech coats cutting tools for a major manufacturer of off-highway equipment.

In tests performed by SurfaceTech, the SL coating has increased tool life by as much as 1,000% when applied on top of hard CVD and PVD coatings such as TiN or TiCN, Aronov says. The tool life improvements are in addition to those gained by the underlying coating.

A major drawback of the coating is that it will not work with all cutting fluids, Aronov says. Because it's organic, some cutting fluids may cause the coating to break down or may interfere with its effectiveness. This means that some testing of the cutting fluid may have to be performed before using the coating, but SurfaceTech has developed an extensive database of compatible cutting fluids, and the company is working with the major cutting-fluid manufacturers to test additional formulations, says Aronov.

However, the coating is working well enough that Bodine is beginning to test it on other cutting tools, says Kotlyar. "We've moved it to our turning machines," he says. The results on those machines are equally impressive. "Double life at least," Kotlyar says.

# AUTOMATIC INSPECTION

... from the Source

Since 1936 **ITW** has provided the gear industry with gear inspection devices. Put your trust in the people who invented the process.



High Speed Automatic Functional Tester



Precision Checking Heads

## Automatic Functional Gear Inspection In-Line Gages

### PRODUCTS AVAILABLE:

- Fully Automatic Machines
- Semi-Automatic Machines
- Manual Double Flank Testers for Course and Fine Pitch Gears
- Dimension over Pins/Balls Gage

### FEATURES:

- Composite Gaging
- Composite/Center Distance Checks
- Lead/Taper Checks
- SPC Capabilities
- Data Acquisition Screens

For additional information on **Gear Burnishing** and/or **Functional Gear Inspection**, visit our website at: [www.itwgears.com](http://www.itwgears.com)

**ITW Heartland**

1205 36th Avenue West  
Alexandria, MN 56308 U.S.A.  
Ph: (320) 762-8782  
Fax: (320) 762-5260  
E-mail: itwgears@rea-ulp.com

**TURNKEY SYSTEMS AVAILABLE.  
CUSTOMIZE YOUR APPLICATION:  
BURNISHER + WASHER + INSPECTION GAGE.**

VISIT US AT GEAR EXPO BOOTH #342.

CIRCLE 119

Circle 300

## ATA Merges Cutting, Testing of Large Spiral Bevel Gears

ATA Gears cuts and tests large spiral bevel gears more by sliding cutting and testing spindles around than by transferring the gears between cutting and testing machines.

ATA Gears Ltd. of Tampere, Finland, achieved that change in motion by merging the cutting and testing of large spiral bevel gears from two separate machines into a single gear generator with a testing unit.

The specially made machine consists of cutting, workholding and testing units on a T-shaped base. The cutting unit is on the T's left arm, the workholding unit on its leg, and the testing unit on its right arm.

Resting on guide plates, each unit can be slid to and from the T's intersection, so ring gear and pinion can be finish-machined and single-flank tested while minimizing the amount of switching—and distance—between units.

"New and unique." That's how Pentti Hallila, ATA Gears' general manager of sales and technical services, describes the combining of single-flank testing with large bevel gear cutting.

To produce a spiral bevel gear set, gear manufacturers usually finish-machine a ring gear on a cutting machine, then finish-machine the gear's pinion—leaving a small finishing margin. The gear and pinion are next moved

to a separate testing machine and rotated in tooth contact to see how the pinion must be finished for the set to mesh correctly.

The pinion is then transferred between the cutting and testing machines as many times as needed to create the correct contact pattern.

With its modified machine, ATA Gears slides the cutting and workholding units together to finish-machine a ring

gear. Transferring that gear to the testing unit, the company next finish-machines the pinion. ATA Gears then slides the cutting unit away from the T's intersection and slides the testing unit to the intersection so the gear and pinion can be engaged.

Rotating the workholding unit, the machine can test the ring gear and pinion's contact pattern. The cutting and testing units can be slid back and forth as



An ATA Gears employee kneels between the main parts of a specially modified machine that finish-machines and single-flank tests large spiral bevel gear sets.



# THE PURDY CORPORATION

ISO 9002 CERTIFIED

## Aerospace Manufacturing Technologies For The 21st Century



**AH-64  
Longbow Apache  
Attack Helicopter  
Main Rotor  
Transmission**

**586 Hilliard Street, P.O. Box 1898, Manchester, CT 06045-1898 U.S.A.**  
**Telephone: 860 649-0000 • Fax: 860 645-6293**  
**Home Page: <http://www.purdytransmissions.com>**  
**E-Mail: [sales@purdytransmissions.com](mailto:sales@purdytransmissions.com)**

© 1998 THE PURDY CORPORATION

CIRCLE 123

often as needed to finish the pinion so it meshes correctly with the ring gear.

Pekka Hoikkala, ATA Gears' production engineer, came up with the idea of minimizing the transferring of gears between separate machines by merging the cutting and testing processes into a single machine. That machine is a modified Klingelberg AMK 1604 bevel gear cutting machine.

After coming up with the idea, ATA Gears applied for a patent on it and presented it to Klingelberg Söhne GmbH of Hückeswagen, Germany.

"They modified the machine accordingly," Hallila says.

He estimates that the modified machine is about 5 meters tall, 7 meters wide and 7 meters long, taking up about 50 square meters of floor space and weighing about 52 metric tons.

The machine was brought into full, online production in early 1999. ATA Gears sold more than 70 large spiral bevel gear sets that year, then again in

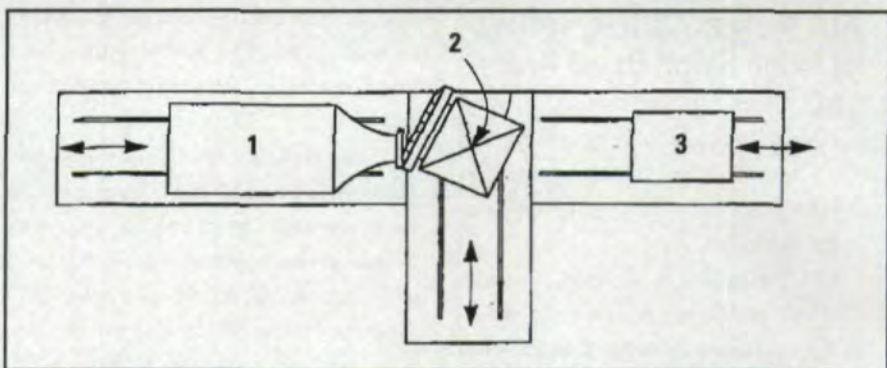

In its modified machine, ATA Gears uses the cutting unit (1) and the workholding unit (2) to finish-machine a large ring gear . . . .

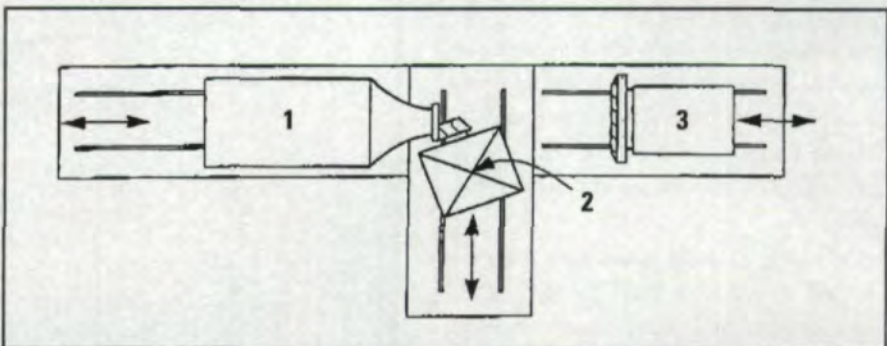

ATA Gears next slides the ring gear away from the cutting unit, takes it off the workholding unit and places it on the testing unit (3). The company places the ring gear's pinion on the workholding unit, slides it up to the cutting unit, and finish-machines the pinion . . . .

RTS-RIEGELTEAM.DE

# Point of Precision

## Tools of Precision



At Klingelberg, the point of precision is to help you control your gear manufacturing process and improve gear quality with measuring systems that are benchmarks for:

Klingelberg P series CNC gear checkers feature 4-axis measuring technology to inspect parts up to



2000. Hallila defines a large spiral bevel gear—that is, a ring gear—as one with a diameter greater than 40 inches.

Using the modified machine, ATA Gears can manufacture spiral bevel gears up to 100 inches in diameter.

Other companies—Amarillo Gear Co. of Amarillo, TX; Brad Foote Gear Works Inc. of Cicero, IL; and Foote-Jones/Illinois Gear of Chicago—can manufacture such gears, cutting and test-

ing them on separate machines.

Such large spiral bevel gears are used by businesses involved in heavy engineering for crushers and in marine equipment for propelling ocean-going ships and offshore vessels, like drilling rigs. The gears are also used in coal mills for pulverizing coal and cement mills for pulverizing cement.

ATA Gears started making its large spiral bevel gears in 1998.

“The market was going to larger and larger units,” Hallila explains. He says the trend was true regardless of industry, but he adds the markets for large spiral bevel gears are very limited.

“They are a part of our daily operation,” Hallila says about the large gears, “but they are special ordered.”

ATA Gears created the modified machine, changing from transferring large gears between cutting and testing machines to sliding spindles around, to save time and increase productivity.

Circle 302

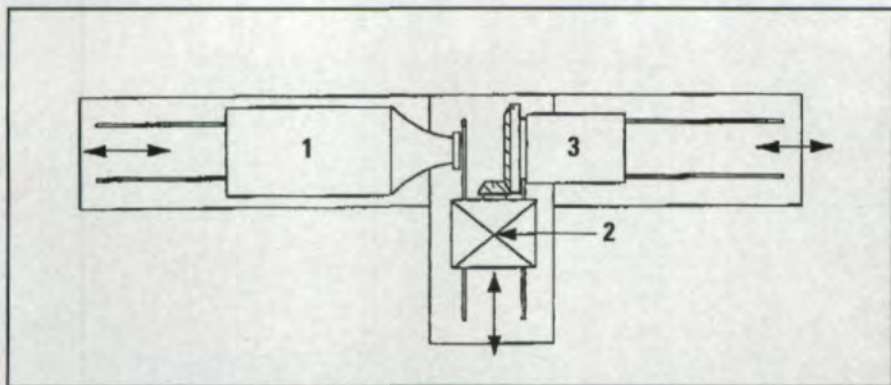

ATA Gears then slides the cutting unit away from the pinion and slides the testing unit up, to test the gear set's contact pattern. The company can slide the cutting and testing units back and forth until the contact pattern is correct.

**Tell Us What You Think . . .**

If you found this column of interest and/or useful, please **circle 303**.

If you did not care for this column **circle 304**.

If you would like to respond to this or any other article in this edition of *Gear Technology*, please fax your response to the attention of Randy Stott, managing editor, at 847-437-6618 or send an e-mail message to [people@geartechnology.com](mailto:people@geartechnology.com).

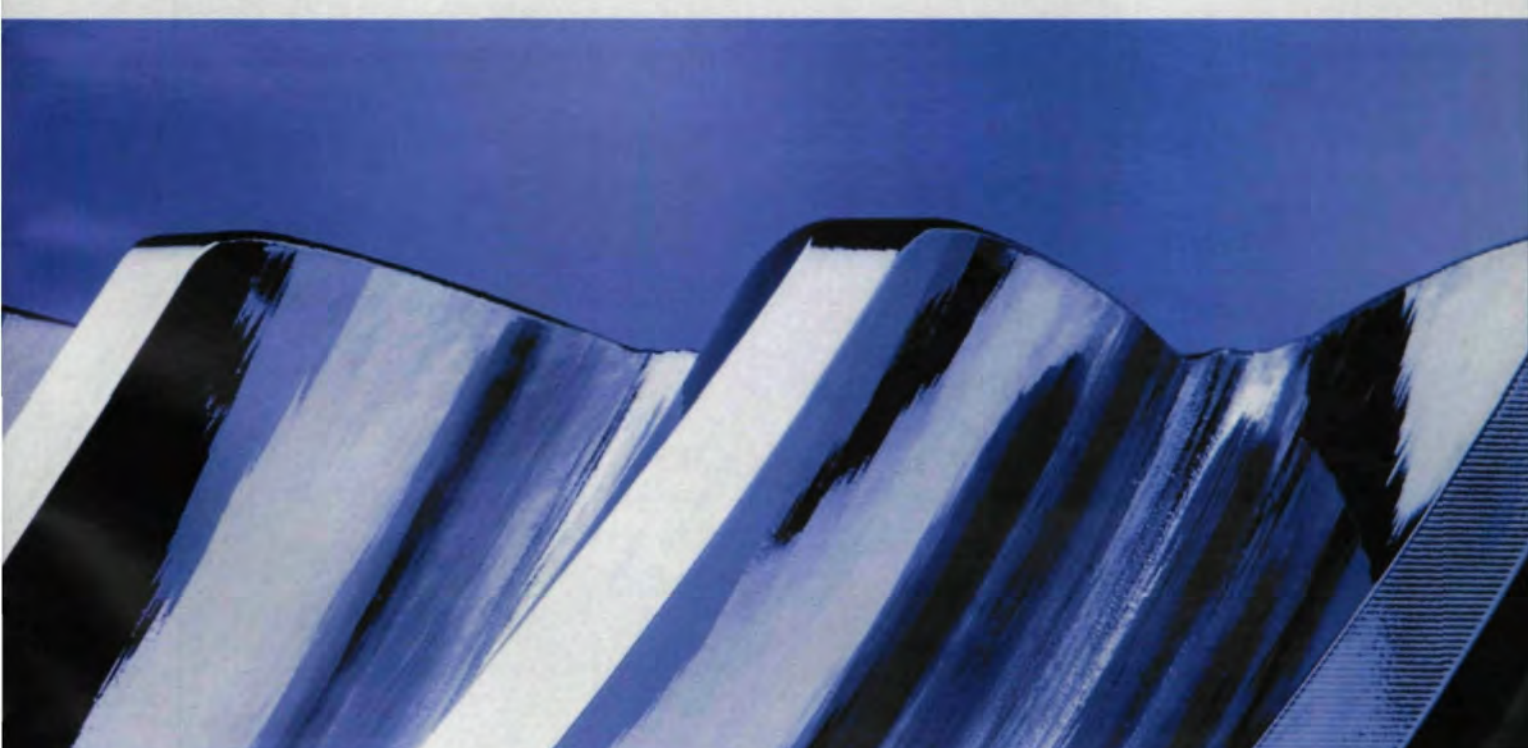

- accuracy
- reliability
- maintainability
- flexibility
- performance
- and life cycle cost.

For more information about Klingelberg measuring technology contact: Liebherr Gear Technology Co. 1465 Woodland Drive Saline, MI 48176-1259

Phone: +1-734-429-7225  
 Fax: +1-734-429-2294  
[www.pointofprecision.com](http://www.pointofprecision.com)  
[info@pointofprecision.com](mailto:info@pointofprecision.com)



2600mm diameter.



# TENTH

*International Induction Heating Seminar*

*October 17 - 19, Clearwater Beach, Florida*

**The world's largest group of experts from the U.S., Europe, Australia, South America and Asia will present information on NEW processes and developments in induction heating.**

- Non-rotational crankshaft hardening • Desired metallurgical properties
- Induction hardening of camshafts, gears & critical components • Quenchants
- Slab, strip, tube & pipe heating • IGBT & Mos-Fet transistorized power supplies
- Cracks, shape & distortion control • Ferrous & non-ferrous metals
- Diagnostics, monitoring & QA • New coil design technologies • And more

**Bring your questions, concerns and everyday induction heating experiences to world recognized experts and end-users to get the advice and answers that you're looking for.**

Register now for only \$295 per person. For more information please contact Laurie Taylor at 248/585-9393 or visit [www.inductoheat.com](http://www.inductoheat.com).



Contact: Laurie Taylor • 32251 N. Avis Drive • Madison Heights, MI 48071 • 248/585-9393 or 800/624-6297  
• Fax: 248/585-0429 • e-mail: [lltaylor@inductoheat.com](mailto:lltaylor@inductoheat.com) • [www.inductoheat.com](http://www.inductoheat.com)

CIRCLE 161

# Material Properties and Performance Considerations for High-Speed Steel Gear-Cutting Tools

Ed Tarney and Joanne Beckman

Users of gear-cutting tools probably do not often consciously consider the raw material from which those hobs, broaches or shavers are made. However, a rudimentary awareness of the various grades and their properties may allow tool users to improve the performance or life of their tools, or to address tool failures. The high-speed steel from which the tool is made certainly is not the only factor affecting tool performance, but as the raw material, the steel may be the first place to start.

## High-Speed Steels

High-speed steels are so named because of their ability to machine other materials at high speeds. They are complex, iron-based alloys made of various carbide-forming elements, plus sufficient carbon, so when heat-treated, they exhibit a microstructure of a hard steel matrix containing harder carbide particles. High-speed steels are designed to provide the following attributes:

- High hardness,
- High wear resistance/abrasion resistance,
- High red hardness, and
- Good toughness.

All of those attributes are influenced by the chemical composition of the alloy. In addition, the manufacturing of the steel can influence toughness.

## Compositions of High-Speed Steels

The characteristic elements found in most high-speed steels are chromium (Cr), molybdenum (Mo), tungsten (W) and vanadium (V). Carbon is present only to the extent needed to form the desired carbides and to provide the high matrix hardness after heat treatment. Therefore, the carbon content is generally increased in direct proportion to the rest of the carbide-forming elements. Some high-speed steel grades also contain cobalt (Co). The nominal compositions of a number of high-speed steels are shown in Table 1.

High-speed steels generally contain about 4% chromium. Chromium is mainly responsible for through hardenability, the ability to uniformly harden a large section during heat treating.

High-speed steels attain their maximum hardness after tempering at 1,000°F or hotter. The characteristic of gain-

Table 1—Nominal compositions of some high-speed steels, approximate weight percent.

Grade	C	Cr	W	Mo	V	Co
T1	0.75	4	18	-	1	-
M1	0.85	4	1.5	8.5	1	-
M7	1.0	4	1.5	8.5	2	-
M42	1.1	4	1.5	9.5	1	8
M2	0.85	4	6	5	2	-
M3	1.2	4	6	5	3	-
M4	1.4	4	6	5	4	-
M35	1.0	4	6	5	2	5
T15	1.6	4	12	1	5	5
Rex 45	1.3	4	6	5	3	8
Rex 54	1.45	4	6	5	4	5
Rex 76	1.5	4	10	5	3	9
Rex 121	3.4	4	10	5	10	10

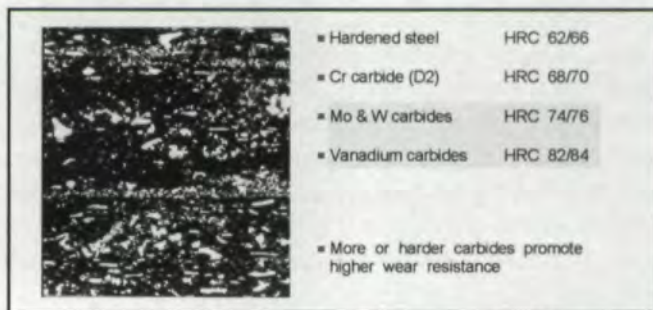

Figure 1—Microstructure of high-speed steel, showing typical carbide morphology.

ing hardness upon exposure to elevated tempering temperatures is called secondary hardening. It provides high-speed steels with their basic resistance to softening while in service, and it comes from a combination of tungsten and molybdenum. Empirically, it has been found that a total tungsten and molybdenum content, wherein the amount of tungsten plus twice the amount of molybdenum stands at about 18%,

## Ed Tarney

is director of international marketing for Crucible Service Centers and was most recently director of its particle metallurgy development. With a master's degree in metallurgy, he has worked more than 20 years for Crucible, in manufacturing, technical support and marketing positions.

## Dr. Joanne Beckman

is director of technical promotions for Crucible Service Centers. Her doctoral degree is in metallurgy. She has worked for Crucible for more than 22 years, in manufacturing, research and marketing positions.

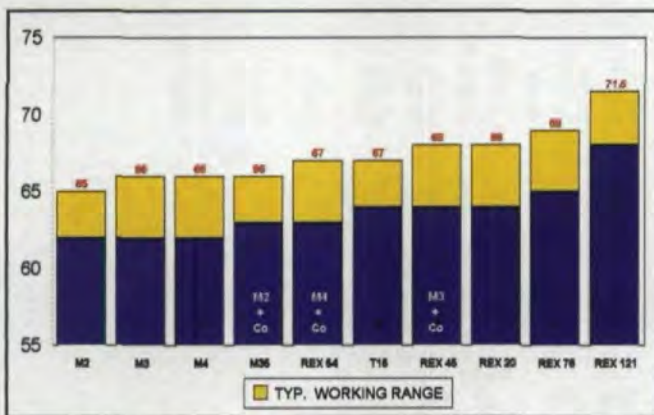

Figure 2—Typical working hardness (HRC) of some high-speed steels. (Typical maximum hardness shown in red.)

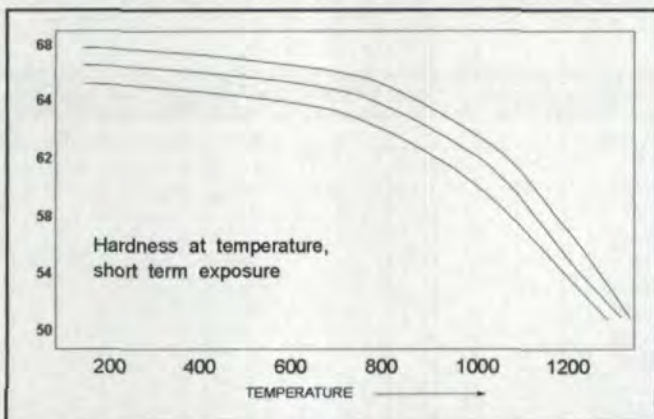

Figure 3—Decrease in hardness (HRC) from room temperature to elevated temperature for high-speed steel. (Hypothetical graph only, to illustrate the relationship.)

is satisfactory to provide the required temper resistance. Thus, high-speed steels may contain 18% W with essentially no Mo, or they may contain 8–9% Mo with only 1–2% W, or they may contain some intermediate level of both. In any case, it is common that the net combined levels are comparable among most grades.

Vanadium, present primarily as vanadium carbides, provides extremely high wear resistance. The hardness of vanadium carbides exceeds that of tungsten or molybdenum carbides (see Figure 1). As a consequence, high vanadium high-speed steels are more abrasion resistant, but they may also be more difficult to grind than lower vanadium grades, specifically

because of the high hardness of the carbides.

Some high-speed steels may also contain cobalt. Cobalt is not a carbide-former, but stays dissolved in the matrix and acts to strengthen the matrix by increasing the overall hardness, as well as the hot hardness and resistance to softening.

Because the effective combined tungsten and molybdenum contents are comparable for many high-speed steels, it is primarily the vanadium and cobalt contents that distinguish the performance properties of the different steels.

#### Hardness

Normal high-speed steels are capable of attaining a hardness of HRC 63 minimum, and most are used in

the range of HRC 62–68. (See Figure 2.) Hardness is a measurement of the resistance to plastic (permanent) deformation, especially in compression. Hardness tests measure the size of the impression (deformation) left by a fixed indenter, and materials are ranked on a relative scale. A tool with insufficient hardness may experience flattening, indenting or mushrooming in use. Room temperature hardness also has an effect on short-term hot hardness. For a given grade, the higher the room temperature hardness, the higher the elevated temperature hardness (see Figure 3). Although high hardness contributes to wear resistance, the two characteristics are not one and the same. It is important to note that the variation in hardness among the many high-speed steels is relatively minor, compared with their variations in wear resistance.

#### Wear Resistance

In gear-cutting tools, wear commonly occurs as erosion of the cutting edge or flank, cratering on a tool face or abrasion on any contact area of the tool. Wear resistance can vary somewhat due to hardness, but it is more strongly influenced by the type and volume of carbide particles present in the microstructure. For example, tools made of M2, M3 and M4 will show a significant increase in wear resistance, even at identical hardnesses, due to the progressive increase in the volume of vanadium carbides. For that reason, the most common grade of high-speed steel used for general purpose hobs and broaches has shifted from M2

through M3 to M4 over recent history, especially as steelmaking technology and grinding capability have improved to better handle the increased vanadium. It should be noted that the overall carbide volume plays a large role in wear resistance, as well as the carbide type.

#### Red Hardness

Red hardness or hot hardness is the resistance to softening of high-speed steels at elevated temperatures, specifically temperatures approximating those an operating tool might experience. Roberts and Cary (Ref. 1) have given the following rule of thumb for good red hardness for high speeds:

*Maintaining a hardness >52 HRC at 1,000°F and >48 HRC at 1,100°F.*

For most practical applications, maintaining as high a hardness as possible during the cutting operation is desirable. As mentioned earlier, red hardness can be influenced somewhat by room temperature hardness, but it is much more significantly affected by the cobalt content. Cobalt-bearing versions of the common high-speed steels were developed specifically to improve red hardness and permit higher cutting speeds. (See Figure 4.) Cobalt-bearing high-speed steels usually contain 5–8% cobalt. Examples of “pairs” of grades with and without cobalt are shown in Table 2. In each pair, the additional cobalt slightly increases the hardness, but greatly improves the red hardness.

Criteria for designing cobalt-bearing high-speed steels has always involved a balance between red hardness and cost. Prior to the development of

P/M (powder metallurgy) high-speed steels, M42 (M1 + 8% Co) was used in broaching, and M35 (M2 + 5% Co) was used in hobs, when increased hardness was desired. Although they permit higher cutting speeds, the cobalt grades offer only limited inherent wear resistance improvements over their non-cobalt counterparts. After the development of P/M steelmaking (discussed below), M3 with 8% Co (CPM Rex 45) and M4 with 5% Co (CPM Rex 54) were developed as cobalt upgrades from conventional M35 for hobs. The 5% V, 5% Co T15 replaced much of the M42 used in broaches. Thus, not only enhanced red hardness, but enhanced abrasion resistance could be obtained as well.

#### Toughness

So far, we have looked at the alloy additions made to high-speed steels to impart the properties of hardness, wear resistance and red hardness. Aside from cost, why aren't high-speed steels made with the maximum alloy content possible to achieve superior properties? The reason is that high-carbon, high-alloy steels are prone to alloy segregation. Tools produced from conventionally made, very highly-alloyed steels are prone to chipping and cracking during tool manufacture and use, and they can be difficult to grind because of the non-uniform carbide size and distribution inherent in the production processes used to make the steels. The segregation problem becomes more pronounced as the carbide-

Table 2—High-speed steel grade pairs with and without cobalt.

Grade	W	Mo	V	Co
M2	6	5	2	-
M35	6	5	2	5
M3	6	5	3	-
Rex 45	6	5	3	8
M4	6	5	4	-
Rex 54	6	5	4	5

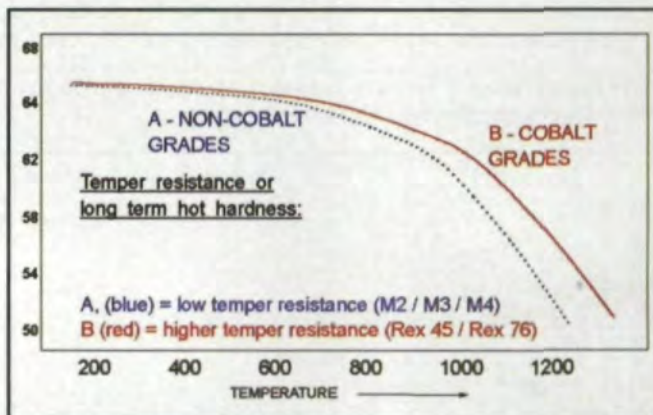

Figure 4—Improved resistance to softening, in HRC, at elevated temperature for cobalt-bearing high-speed steels. (Hypothetical graph only, to illustrate the relationship.)

# When big things are on the move

The specialist in cost-effective hard-broaching of internal splines

**Fässler**  
www.faessler-ag.ch

Fässler Corporation  
131 W. Layton Avenue, Suite 308  
Milwaukee, WI 53207  
Phone (414) 769-0072  
Fax (414) 769-8610  
E-mail: faessler@execpc.com

VISIT US AT GEAR EXPO BOOTH #190.

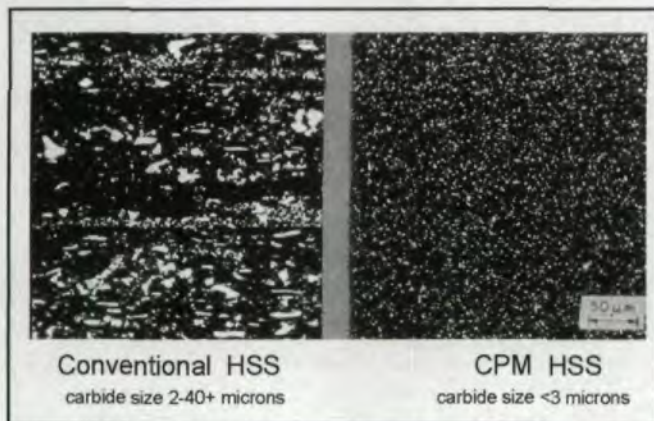

Figure 5—Comparison of microstructures (carbide morphologies) of conventional high-speed steel and CPM high-speed steel.

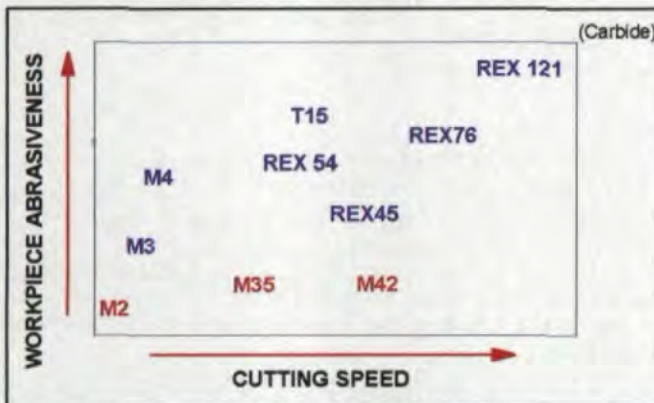

Figure 6—Relative working conditions and appropriate high-speed steel grades. (Cobalt grades shown in red, non-cobalt grades in blue.)

forming elements are increased.

#### P/M Eliminates Segregation

When designing conventionally made alloys for high performance, segregation problems will always limit the maximum amount of alloy content that can be added. In order to permit the manufacture of high-speed steels with higher performance levels, P/M methods are used.

At Crucible Service Centers, the CPM (Crucible particle metallurgy) process begins with a homogeneous bath of liquid steel, similar to conventional melting. Instead of being poured into ingot molds, the molten metal is atomized into spherical powder particles. The powder is loaded into containers, which are sealed and consolidated into a solid under heat and

pressure. The resulting CPM product is fully dense and exhibits a uniform distribution of very fine carbides. Figure 5 illustrates the differences between conventionally produced and CPM bars of T15 with 2" diameters.

Prior to the P/M process, conventionally produced high-speed steels were limited in maximum alloy content due to segregation. High alloy grades were not only difficult to produce, but also were brittle and difficult to machine and grind. Thus, they were impractical for certain applications. The P/M process made possible the development and production of high-speed steels with overall higher alloy content for improved performance. Significantly, it has permitted the development of high vanadium grades

for increased wear resistance without reducing the grindability. In addition, the P/M microstructure imparts a big benefit in toughness.

#### Selection Criteria for High-Speed Steels

How do you translate metallurgical properties into a selection process for the proper high-speed steel for your application? By examining the performance properties desired (or lacking) in current tooling and looking for alternate high-speed steels that may offer the needed properties, improved performance may be expected. Figure 6 shows some theoretical working considerations and appropriate high-speed steel grades.

A common start is a conventional high-speed steel, such as M2. On the low end of alloy content and performance expectations for high-speed steels, M2 is fine for general-purpose applications and adequate for jobs involving less abrasive workpieces, shorter runs or lower accuracy tolerances.

When improvements in tool life (increased number of parts per tool or of parts per sharpening) are desired, M3 and ultimately M4, with their increased vanadium content, can be expected to offer significant improvements over M2. Under the same cutting conditions, M4 would provide better wear resistance and better edge retention. Similarly, M4 would be a better choice if the workpiece is more abrasive, or if higher accuracy is required.

Because they share the same basic matrix chemical composition—except for an increasing volume of vanadium carbides—M2, M3 and

M4 are designed to be used under similar cutting conditions; that is, no significant increase in feeds or speeds would be inherent in such a substitution. T15 is sometimes also considered, because of its 5% vanadium content, for abrasive applications as well. In that case, the benefit of the cobalt is primarily to allow slightly higher hardness to accompany the higher carbide volume for wear resistance.

When productivity issues drive material selection (increased parts per hour, increased cutting speeds), the cobalt-bearing grades permit higher cutting speeds. As discussed, the conventional high-speed steels M42 and M35 do not add any inherent wear resistance or tool life when compared to their non-cobalt-bearing counterparts, but they will stand up better to the higher temperatures encountered at higher cutting speeds. In hobs operating at high speeds, high-performance CPM Rex 45 and CPM Rex 54 offer superior red hardness common to cobalt-bearing grades, plus the excellent wear resistance of M3 and M4 vanadium levels. When cutting speeds are not severe, T15 may also be considered.

When both higher cutting speeds and even higher wear resistance are required, the CPM super high-speed steels offer the simultaneous improvement of both. Both CPM Rex 76 and the new CPM Rex 121 offer combinations of very high red hardness and wear resistance. Those grades have been used, along with appropriate coatings, in dry-cutting applications. They also may provide an alternative to solid carbide

tooling in applications where carbide tools are too fragile, or where machine rigidity or stability may be inadequate for carbide tools.

The proper selection of high-speed steel for your application should also take into consideration the normal failure mode of the tools. Upgrade to a material that provides an enhanced level of the property which addresses that failure mode. For instance, if the typical failure mode in an M2 tool is simply abrasion or wear, a higher vanadium grade, such as M3 or M4, will probably offer satisfactory relief. A cobalt version of the existing grade, such as M35 (M2 + Co) or Rex 45 (M3 + Co) might not add sufficient wear resistance. However, if the desire is to increase cutting speeds, a grade with high red hardness or temper resistance, such as Rex 76, may offer benefits over other cobalt-bearing grades. (See Figure 6.)

The development of coatings has added another level of complexity to the selection process. A good coating may allow higher cutting speeds by decreasing frictional heating at the tool-chip interface. When coated, tools can be used under cutting conditions that the uncoated tool could not withstand. However, the function of the coating is affected by the properties of the substrate, so choose the substrate to match the coating and cutting conditions. For coatings that permit high cutting speeds, it may be important to choose a substrate suitable for high cutting speeds, a substrate that offers extreme temper resistance or red hardness, such as CPM

Rex 76.

The recent interest in dry cutting gives even greater concern to temperature exposure. CPM Rex 121 provides the ability to retain its cutting properties at high temperatures. Designed to be a material to bridge the gap between traditional high-speed steels and carbide, CPM Rex 121 offers significantly higher wear resistance and red hardness than other high-speed steels. When considering coated tools, discuss the application with the tool manufacturer, the coater and materials supplier, each of whom may have important contributions to make toward the eventual success of the tool.

Tool design and manufacturing, the caliber of the heat treating process, and coatings will all contribute to the successful performance of a tool. But, the choice of which material to use for raw material should not be overlooked. To ensure a high-performance tool, start by picking a high-performance high-speed steel. ◉

#### Reference

1. Roberts, George and Robert Cary, *Tool Steels*, 4th ed., American Society for Metals, Metals Park, OH, July 1985.

*Crucible, CPM, Rex, Rex 76 and Rex 121 are registered trademarks of the Crucible Materials Corp.*

#### Tell Us What You Think . . .

If you found this article of interest and/or useful, please circle 311.

If you did not care for this article, circle 312.

If you would like to respond to this or any other article in this edition of *Gear Technology*, please fax your response to the attention of Randy Stott, managing editor, at 847-437-6618 or send e-mail messages to [people@geartechnology.com](mailto:people@geartechnology.com).

## Toolink Engineering

**NEW!** Lightweight Hydraulic Arbor

Light as a Feather

Highest Accuracy

Feather light hydraulic arbors can be manufactured with runout as low as 2 microns. The clamping sleeves are replaceable. This tooling is suitable for measuring, testing, balancing, gear grinding and other applications.

Toolink Engineering offers hydraulic arbors made of a light metal alloy that weigh up to 70% less than a comparable steel arbor.

Toolink Engineering is the exclusive North American distributor of König mtm Work Holding Devices available for the following applications: • Gear Grinding • Gear Shaping • Gear Hobbing • Gear Shaving • Tool Grinding • Testing • I.D. • O.D. Grinding • Balancing • Turning • Milling.



Toolink Engineering  
2870 Wilderness Place  
Boulder, CO 80301  
PH 303.938.8570  
FAX 303.938.8572  
[www.toolink-eng.com](http://www.toolink-eng.com)

VISIT US AT GEAR EXPO BOOTH #101.

CIRCLE 153

**Unmatched Capabilities,\*  
Unmatched Solutions...  
Get to Know Bourn & Koch!**

- \* OEM Gear Hobbers
- \* OEM Gear Grinders
- \* OEM Hob Checkers
- \* Gear Manufacture
- \* Gear Seminars
- \* Gear Software
- \* Remanufacture/Retrofit/Recondition/Repair of Your Barber-Colman Hobber/Shaper/Hob Sharpener/Hob Checker
- \* Parts/Field Service for Barber-Colman, Ferguson and Bourn & Koch Products

**BOURN & KOCH**  
MACHINE TOOL CO.

2500 Kishwaukee St. • Rockford, IL 61104  
Phone: 815/965-4013 • Fax: 815/965-0019  
E-mail: [bournkoch@worldnet.att.net](mailto:bournkoch@worldnet.att.net)  
Internet: [www.bourn-koch.com](http://www.bourn-koch.com)

VISIT US AT GEAR EXPO BOOTH #576.

CIRCLE 144

# From a brilliant idea to a Gear Grinder

Big planetary gear reducers – and consequently internal ring gears – gain more and more importance in the gear industry.

Since sun pinions and planet gears are typically carburized and ground already, it is expected that internal ring gears need to be ground also for various reasons – especially when we consider the poor hobbed accuracy of these gears.

When we started to think about designing a combined internal-external gear grinder we checked of course what others do – and we were shocked. Endless hours to mount so-called internal grinding heads,

limited working range, poor quality and performance and all that at a purchase price that lets you quickly forget to even consider making good quality planetary gear boxes.

As a result, we decided to design a completely new machine instead of adding attachments to already existing equipment.

This was the birthday of the PORTA. A gantry type machine design with one standard universal form grinding head mounted to a massive gantry made from mineral cast, with an 80 inch machine table for 77000 lbs of gear weight.

The PORTA grinds internal and external gears up to 120 inches in diameter “by the turn of a switch” without changing the grinding head. As an example: You can grind a complete planetary gear set with sun pinion, planets and ring gear without complicated change over of the machine.

The grinding wheel swivels up to 45 degree helix angle, the grinding wheel is dressed with the on machine dresser. Checking of the gear follows with the built-in checker.

The PORTA is another example of Höfler’s engineering capability. Always looking for customer needs, Höfler continues to offer intelligent manufacturing solutions.

At the Gear Expo see the:

## HELIX 400 K

For spur and helical gears up to 16 inch in diameter. The new series of HELIX machines offer

- an extended working range and a higher table load capacity,
- a completely redesigned tailstock system with enlarged center distance,
- improved cycle times due to new drive systems and special strategies,
- on-machine gear inspection for profile, lead and spacing,
- grinding wheel diameters reduced to less than 2 inch without spindle change,
- automatic shift axis correction for CBN grinding wheels,
- grinding of internal and external gears without machine change over.

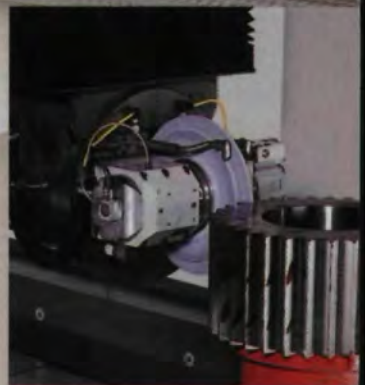



a fantastic  
inding Machine.



ORTA

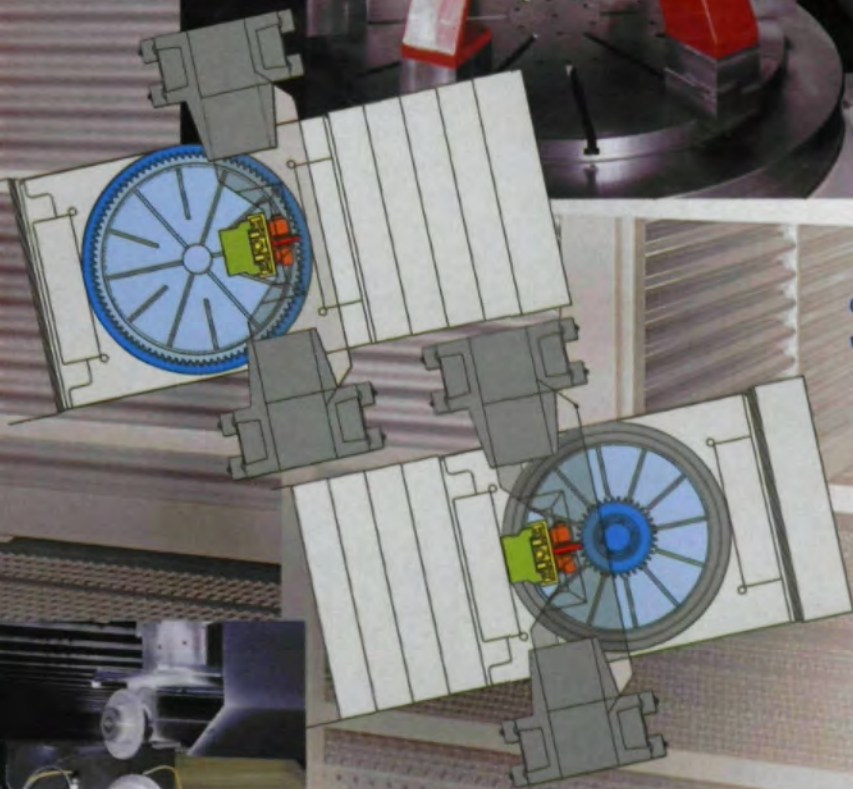
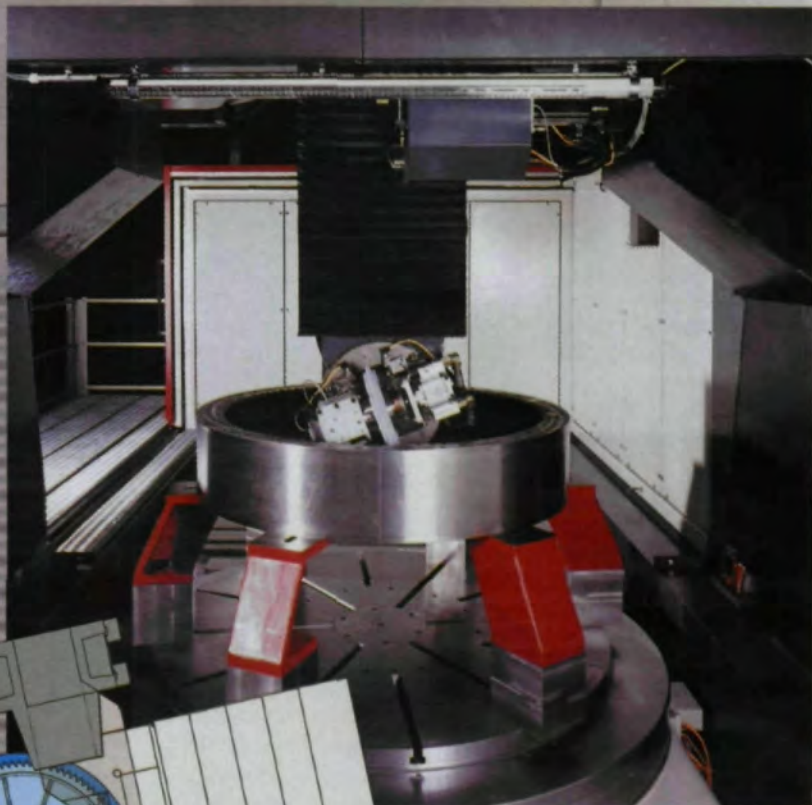

OCTOBER 7-10, 2001  
Gear  
Expo  
DETROIT, MICHIGAN



**HÖFLER GMBH**  
Industriestr. 19  
D-76275 Ettlingen/Germany  
Tel. +49 7243 599 162  
Fax +49 7243 599 165

**HÖFLER Corp.**  
Sky Manor Road  
Pittstown, N.J. 08867  
Phone (908) 996-6922  
Fax (908) 996-6977

E-mail: [info@hoefler.com](mailto:info@hoefler.com), Internet: <http://www.hoefler.com>

# Metric Worms & Wormgears

With our selection of standardized metric worm gear sets, QTC will meet all of your worm gear requirements

Available from stock are modules 0.5 thru 6 in ratios of 100:1 to 20:1

Materials Include Alloy Steel, Stainless Steel, Carbon Steel, Aluminum Bronze, Bronze, Cast Iron & Nylon



Quality  
Transmission  
Components

[www.qtcgears.com](http://www.qtcgears.com)

Division of Designatronics, Inc.

Phone: 516-437-6700 • Fax: 516-358-9478

**KHK**

VISIT US AT GEAR EXPO BOOTH #434.

CIRCLE 137

## Correction

The article "Design Formulas for Evaluating Contact Stress in Generalized Gear Pairs," from the May/June 2001 issue, contained an error.

Equation 11b, found on page 36, should have read:

$$r_b = \left[ C \left( \frac{K_{\min}}{K_{\max}} \right)^{1/4} \frac{1}{K_{\max}} \right]^{1/3}$$

We apologize for any inconvenience.

—The Editors.

## TECHNICAL CALENDAR

**Sept. 5–7—Basic Gear Noise Short Course.** Ohio State University, Columbus, OH. Covers design of gears to minimize major excitations of gear noise and fundamentals of noise generation and measurement. In workshop session, people will be able to discuss their specific gear and transmission concerns. \$1,250. Contact Donald Houser by telephone at (614) 292-5860, by e-mail at [houser.4@osu.edu](mailto:houser.4@osu.edu), or on the Internet at [www.gearlab.org](http://www.gearlab.org).

**Sept. 10–11—Advanced Gear Noise Short Course.** Ohio State University, Columbus, OH. Advanced course includes lectures and hands-on workshops. Depending on attendees' interests, topics may include computer modeling and experimental approaches. \$900. Contact Donald Houser by telephone at (614) 292-5860, by e-mail at [houser.4@osu.edu](mailto:houser.4@osu.edu), or on the Internet at [www.gearlab.org](http://www.gearlab.org).

**Oct. 2–4—Plastics USA 2001.** McCormick Place, Chicago, IL. Event expected to include technologies relevant to processors serving the gear market and other markets, like the automotive market. Co-sponsored by the Society of the Plastics Industry Inc. (SPI) and the Society of Plastics Engineers. Contact SPI by telephone at (202) 974-5235, by fax at (202) 296-7243, by e-mail at [tradeshows@socplas.org](mailto:tradeshows@socplas.org), or on the Internet at [www.plasticsusa.org](http://www.plasticsusa.org).

**Oct. 16–19—Plastic Gear Design and Manufacturing.** Universal Technical Systems Inc., Rockford, IL. Teaches basic and advanced gear design and theory. Includes an hour of gear consulting on last day of training course. \$995. Contact Phil Cooper at (815) 963-2220, or send an e-mail message to [sales@uts.com](mailto:sales@uts.com).

**Oct. 23–26—Metal Gear Design and Manufacturing.** Universal Technical Systems Inc., Rockford, IL. Teaches basic and advanced gear design and theory. Includes an hour of gear consulting on last day of training course. \$995. Contact Phil Cooper at (815) 963-2220, or send an e-mail message to [sales@uts.com](mailto:sales@uts.com).

*Additional events can be found on the technical calendars at [www.gartechnology.com](http://www.gartechnology.com) and [www.powertransmission.com](http://www.powertransmission.com).*

*If you have an event you want included in the technical calendar, you can fax information about the event to Gear Technology, to the attention of Joseph L. Hazelton, associate editor, at 847-437-6618.*

### Tell Us What You Think . . .

If you found this column of interest and/or useful, please circle 309.

If you did not care for this column, circle 310.

If you would like to respond to this or any other article in this edition of *Gear Technology*, please fax your response to the attention of Randy Stott, managing editor, at 847-437-6618 or send e-mail messages to [people@gartechnology.com](mailto:people@gartechnology.com).

# Measuring Base Helix Error on a Sine Bar

Richard L. Thoen

## Introduction

Base helix error—the resultant of lead and profile errors—is the measured deviation from the theoretical line of contact (Fig. 1). It can be measured in the same way that lead error on a spur gear is measured, namely, by setting a height gage to height  $H$  based on the radial distance  $r$  to a specified line of contact (Fig. 2), rotating the gear so as to bring a tooth into contact with the indicator on the height gage, and then moving the height gage along two or more normals to the plane of action. The theoretical line of contact on a helical gear must be parallel to the surface plate, which is attained by mounting the gear on a sine bar (Fig. 3).

## Advantages

The measurement of base helix is not afflicted with the errors inherent to the measurement of lead and profile. Specifically, a perfect gear mounted off-center on lead and profile measuring machines will appear to have errors in lead and profile, respectively. In practice, off-center errors can be circumvented by taking the average of measurements on two, three or four equispaced teeth— $180^\circ$  for even tooth numbers,  $120^\circ$  for tooth numbers that are a multiple of three, and  $90^\circ$  for tooth numbers that are a multiple of four. (Actually, measuring four equispaced teeth is superfluous, since four is a multiple of two.)

However, averaging is based on the lead and profile errors being the same on all teeth—a condition not typical of formed gearing (molded plastic, die cast, powder metal, stamped, cold-drawn). Consequently, if the averages for various sets of equispaced teeth on the same gear are significantly different, then the lead and profile measurements are not valid. Moreover, discrepant averages denote that the gear is out-of-round, i.e., that it has a multitude of unknown centers.

Also, even when the lead and profile errors are the same on all teeth, the averages for various sets of teeth on the same gear can be significantly different whenever the measured teeth are not equispaced, particularly so when the tooth number is low and prime (5, 7, 11 . . .).

Conversely, the measurement of base helix is not in error when the gear is mounted off-center (no need for averaging), or when the center is unknown. For instance, from Figure 2, it is seen that if the spur gear is slightly lower than shown, then the gear is rotated counterclockwise to bring the tooth into contact with the indicator on the height gage. The rotation places the line of contact at a slightly greater radial distance on the tooth. And the same holds true for a helical gear mounted on a sine bar.

## Nomenclature

$a$	Distance from centerline of gear to centerline between rolls (Fig. 3)
$b$	Distance along base of sine bar from center of lower roll to edge of gear (Fig. 3)
$d$	Diameter of rolls
$F$	Effective face width
$F_m$	Measurable face width
$H$	Height gage setting
$H_{if}$	Height gage setting for $r_{if}$
$H_{of}$	Height gage setting for $r_{of}$
$L$	Distance between centers of rolls (Fig. 3)
$N$	Number of teeth on gear
$P_n$	Normal diametral pitch
$r_b$	Radius of base circle
$r_{if}$	Inside form radius
$r_{of}$	Outside form radius
$\phi$	Transverse profile angle
$\phi_n$	Normal profile angle
$\psi$	Helix angle
$\psi_b$	Base helix angle



Sine bar setup for checking base helix error. Courtesy of Koro Industries Inc., Minneapolis, MN.

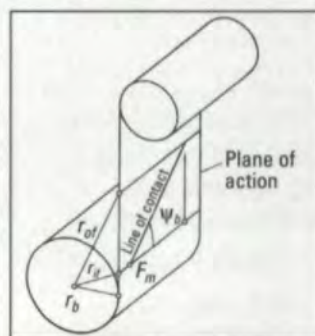

Fig. 1—Line of contact on a helical gear.

## Richard L. Thoen

is a consultant specializing in medium- and fine-pitch gearing. He is the author of several articles and papers on measurement, involute mathematics, statistical tolerancing and other gearing subjects.

## We offer gear technology training opportunities

- **Fundamentals of Gear Design Part 1 of 2**  
November 28-30, 2001
- **Fundamentals of Gear Design Part 2 of 2**  
March 20-22, 2002
- **Bevel Gear Systems**  
October 17-19, 2001
- **PC Applications in Gear Design**  
May 15-17, 2002

All courses are held in Milwaukee, WI and feature Ray Drago, P.E.

For course details go to our web site at:

[www.uwm.edu/dept/ccee](http://www.uwm.edu/dept/ccee)

CIRCLE 154



### GROUND GEARS—Ten or Ten Thousand

For small to medium quantities of spurs or helicals that have to meet close-tolerance AGMA or DIN specs, our Reishauer grinders and M&M gear analysis systems are the perfect combination.

For Long runs, we offer the unique Liebherr CBN grinding process with full SPC quality control and documentation.

So whether your needs are for ten or tens of thousands, we invite you to join the growing list of INSCO customers who rely on us for consistent quality, reasonable costs, and reliable delivery.



PHONE: 978-448-6368  
 FAX: 978-448-5155  
 WEB: [inscocorp.com](http://inscocorp.com)

412 Main Street, Groton, Massachusetts 01450

ISO 9001 Registered

CIRCLE 148

## MEASUREMENT

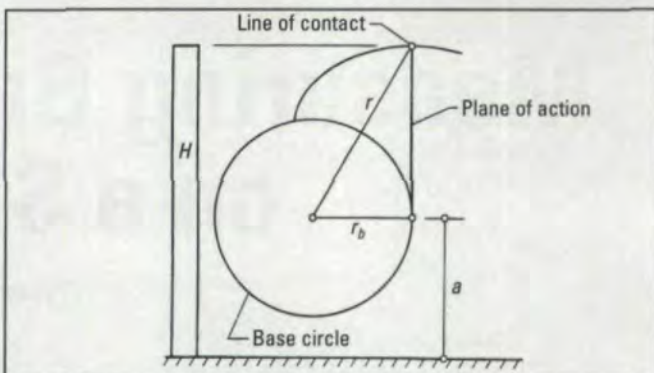

Fig. 2—Arrangement for measuring lead error on a spur gear.

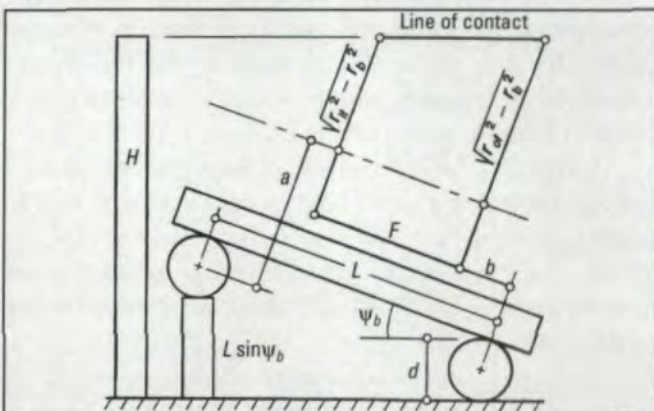

Fig. 3—Arrangement for measuring base helix error on a helical gear.

### Basic Geometry

In Figure 3,  $F$  is the effective face width (minimum face width less chamfer or edge round),  $r_{of}$  is the outside form radius (minimum outside radius less chamfer or tip round), and  $r_{if}$  is the inside form radius (lowest point at which the mating gear can make contact). The distances  $a$  and  $b$  are derived from dimensions on the sine bar, gear and workholding fixture.

The radius of the base circle is (from well-known equations)

$$r_b = \frac{N \cos \phi}{2P_n \cos \psi}$$

where  $N$  is the number of teeth,  $P_n$  is the normal diametral pitch,  $\psi$  is helix angle, and  $\phi$  is the transverse profile angle, where

$$\tan \phi = \frac{\tan \phi_n}{\cos \psi}$$

where  $\phi_n$  is the normal profile angle.

As seen in Figure 3, when the theoretical line of contact intersects the outside and inside form radii at the ends of the effective face width, the height gage is set to height  $H$ . In this case, the effective face width is the same as the measurable face width  $F_m$ , i.e.,

$$F = F_m = (\sqrt{r_{of}^2 - r_b^2} - \sqrt{r_{if}^2 - r_b^2}) / \tan \psi_b$$

where (from the well-known equation)

$$\sin \psi_b = \sin \psi \cos \phi_n$$

where  $\psi_b$  is the base helix angle.

In general, however, the theoretical line of contact does not intersect the outside and inside form radii at both ends of the effective face width simultaneously. In particular, from Figure

3, it is seen that when the theoretical line of contact intersects the outside form radius at one end of the effective face width, the height gage is set to

$$H_{of} = (a + \sqrt{r_{of}^2 - r_b^2}) \cos \psi_b + b \sin \psi_b + (d/2).$$

And when the theoretical line of contact intersects the inside form radius at the other end of the effective face width, the height gage is set to

$$H_{if} = (a + \sqrt{r_{if}^2 - r_b^2}) \cos \psi_b + (b + F) \sin \psi_b + (d/2).$$

Thus, for these two settings of the height gage, the entire effective face width is covered, provided that  $2F_m \geq F$ . And the overlap  $v$  is  $2F_m - v = F$ , i.e.,  $v = 2F_m - F$ . However, if  $2F_m < F$ , then a gap equal to  $F - 2F_m$  in the middle of the face width is not covered. Even so, the middle can be covered by simply raising and lowering the value of  $b$  in the equations for  $H_{of}$  and  $H_{if}$ , respectively.

Specifically, if  $2F_m < F \leq 3F_m$ , then three settings of the height gage are made. The two overlaps are  $3F_m - 2v = F$ , i.e.,  $v = (3F_m - F)/2$ , and the value of  $b$  is either raised in  $H_{of}$  or lowered in  $H_{if}$  by  $\Delta b + v = F_m$ , i.e., by  $\Delta b = (F - F_m)/2$ .

Likewise, if  $3F_m < F \leq 4F_m$ , then four settings of the height gage are made. The three overlaps are  $v = (4F_m - F)/3$ , and the value of  $b$  is raised and lowered in  $H_{of}$  and  $H_{if}$ , respectively, by  $\Delta b = (F - F_m)/3$ .

The following example illustrates the procedure:

Given that

$N$	= 4
$P_n$	= 16
$\phi_n$	= $20^\circ$
$\psi$	= $35^\circ$
$r_{of}$	= 0.2607
$r_{if}$	= 0.1434
$a$	= 1.9847
$b$	= 1.5102
$F$	= 0.7500
$d$	= 0.7422

Then, from  $\tan \phi = \tan \phi_n / \cos \psi$ , the transverse profile angle  $\phi = 23.95680^\circ$ , so  $r_b = 0.139451$ . And from  $\sin \psi_b = \sin \psi \cos \phi_n$ , the base helix angle  $\psi_b = 32.6146^\circ$ , so  $H_{of} = 3.0424$ ,  $H_{if} = 3.2892$  and  $F_m = 0.29200$ .

Since  $2F_m < F \leq 3F_m$ , a third setting of the height gage is made. The two overlaps are  $v = (3F_m - F)/2 = 0.063$ , and the  $\Delta b = (F - F_m)/2 = 0.2290$ . So, in  $H_{of}$ , the  $b$  becomes  $1.5102 + 0.2290 = 1.7392$ , which results in  $H_{of} = 3.1658$ . ☉

#### Tell Us What You Think . . .

If you found this article of interest and/or useful, please circle 321.

If you did not care for this article, circle 322.

If you would like to respond to this or any other article in this edition of *Gear Technology*, please fax your response to the attention of Randy Stott, managing editor, at 847-437-6618 or send e-mail messages to [people@geartechnology.com](mailto:people@geartechnology.com).

# Fässler

High quality and competitive pricing...

From the people who invented the Fässler DSA Grinding Wheel Dressing process:

We would like to present our new module range of diamond dressers for flank and tip dressing.



Your benefits:

- Increased tool life
- Attractive, factory-direct pricing
- Original Swiss-precision quality
- Higher wear resistance
- Better cutting ability
- Short delivery
- For Fässler DSA, Reishauer SPA and RP2 systems

Contact us with your requirements at:

Fässler Corporation

131 W. Layton Ave., Ste. 308, Milwaukee, WI 53207

Phone: (414) 769-0072 • Fax: (414) 769-8610

E-mail: [fassler@execpc.com](mailto:fassler@execpc.com)

VISIT US AT GEAR EXPO BOOTH #190.

CIRCLE 185

## MicroCheck®

The Gear Analyzing Software System!

Windows 95 & 98  
Windows NT  
Compatible

Y2k  
Compliant



Highly advanced, simple to use & extremely accurate...  
MicroCheck can be adapted to your existing gear rolling tester of any make or model. Evaluating your gears to AGMA, DIN, or your own specific tolerances, your test results will be observed on the screen or quickly downloaded to your printer. "SPC & STATISTICS"

MicroGear

13338 Monte Vista Avenue, Chino, CA 91710  
phone 909 590-7363 • fax 909 590-8784

CIRCLE 189

# Mitsubishi narrowed the focus.



Certificate Number FM 57549



**MITSUBISHI HEAVY INDUSTRIES, LTD.**  
**MACHINE TOOL DIVISION**

ISO 9001

QS 9000 TE



# To give you a broader view.

We've consolidated all of our North American gear cutting technologies into one independent organization. And moved the entire operation to a new technology center in the Detroit area, at the hub of global powertrain engineering.

No dealers. No distributors. Rather, career specialists seasoned in every aspect of international gear production requirements and solutions.

The new Mitsubishi Gear Technology Center is your single source for the broadest array of gear production technology in the world. From our patented high-speed dry cutting machines and hobs through gear shapers, shavers, and honing machines, to complete stand-alone gear production centers.

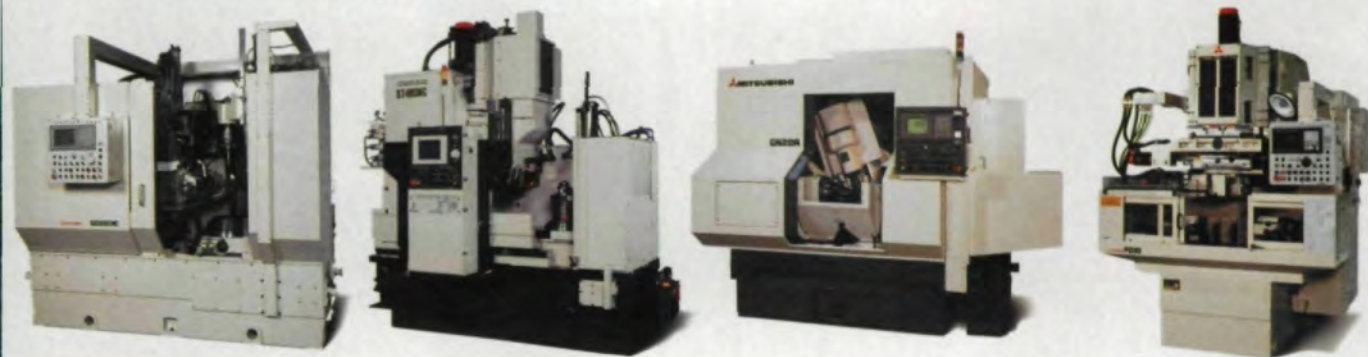

All applied with a comprehensive understanding of the most demanding production environments. And backed with training and service by the industry's most knowledgeable and reliable engineers and technicians.

If your current manufacturing challenges require the detailed focus of the world's foremost authority on gear production, give us a call. After all, we're in the neighborhood.



## **Gear Technology Center**

Division of Mitsubishi International Corporation

Detroit Branch

46992 Liberty Drive

Wixom, Michigan 48393

(248) 669-6136

(248) 669-0614 FAX

[www.mitsubishigearcenter.com](http://www.mitsubishigearcenter.com)

# GEAR EXPO 2001

## *The World of Gearing*

*Sponsored by the*  
American Gear Manufacturers Association

**COBO CENTER  
DETROIT, MICHIGAN  
OCTOBER 7 - 10, 2001**

**FOR MORE INFORMATION, CONTACT:  
AMERICAN GEAR MANUFACTURERS ASSOCIATION**

- PHONE (703) 684-0211
- FAX (703) 684-0242
- EMAIL: [GEAREXPO@AGMA.ORG](mailto:GEAREXPO@AGMA.ORG)
- WEBSITE: [WWW.AGMA.ORG](http://WWW.AGMA.ORG)

**VISIT US AT GEAR EXPO BOOTH #300.**

CIRCLE 133





# Appointments and Partnerships

## Goodfellow Becomes SU America's President



David W. Goodfellow

David W. Goodfellow became president of SU America Inc. on June 6.

Goodfellow is the former president of American Pfauter Ltd. Partnership and former chairman and president of Pfauter-Maag Cutting Tools Ltd. Partnership. He is vice president and group officer for Meritage Inc. of Santa Fe Springs, CA, and will continue to serve Meritage in his present duties.

According to a press release, SU America teamed June 6 with Meritage national companies and their 30 distribution affiliates in North America to cover that territory, providing North American gear manufacturers with more access to SU America products and services.

SU America is a part of Samputensili S.p.A. of Bologna, Italy and a part of the multinational Maccaferri Industrial Group of companies. Samputensili and its sister company, Hurth Modul in Chemnitz, Germany, produce machines, tools and services for the gear manufacturing industry.

Serving the metalworking industry, Meritage Inc. provides machine tools, engineering, product and application services, and financing.

## Brian Cluff Becomes Meritage Vice President

Brian Cluff has joined Meritage Inc. of Santa Fe Springs, CA, as vice president of corporate marketing, according to a press release.

Cluff came to Meritage from Gleason Corp. of Rochester, NY, which he served as vice president of worldwide sales and marketing. In the gear industry more than 35 years, he has worked for

American Pfauter and Pfauter-Maag Cutting Tools. Those companies were purchased by Gleason in 1997.

Cluff is co-author of the gear-manufacturing book, *Gear Process Dynamics*. He has served on the Aerospace Gearing Committee and the Expo Advisory Council for the American Gear Manufacturers Association. He also has served on the IMTS Show Committee for the Association for Manufacturing Technology.

Serving the metalworking industry, Meritage Inc. provides machine tools, engineering, product and application services, and financing.

## Mahr to Use Gleason G-AGE Software on PRIMAR Measuring Machine

Gleason Corp. of Rochester, NY, has granted Mahr Federal Inc. in North America and Mahr GmbH outside North America the right to use Gleason's *G-AGE* software on Mahr's PRIMAR form and gear measuring machine.

Besides that non-exclusive right, Mahr also can offer the *G-AGE* user license with the machine.

According to a press release, the PRIMAR MX 4 is best suited for inspecting high-quality gears. Located in Providence, RI, Mahr Federal said when a company manufactures such gears, measuring data must be immediately returned from quality assurance to compensate for errors on the gear-cutting machine. Mahr Federal also said *G-AGE*, developed for Gleason gear-cutting machines, allows for automatic calculating of correction values based on measurement data, helping PRIMAR customers to improve the quality of bevel gears they produce on Gleason machines.

Also, under their agreement, Gleason will offer Mahr's PRIMAR machine as an option to Gleason's customers.

## Neil Sawyer Is Named Vice President of Mitsubishi Gear Center



Neil G. Sawyer

Neil G. Sawyer was named vice president of customer service for the Gear Technology Center, a division of Mitsubishi International Corp. The center is located in

Wixom, MI, a Detroit suburb.

According to a press release, in his new position, Sawyer is responsible for all North American service, spare parts and documentation of the company's line of gear-cutting machines and systems.

Sawyer was most recently a sales account manager in the production machinery division of Ingersoll Milling Machine Co. of Rockford, IL.

According to the center's president, Thomas P. Kelly, the center's proactive, service-first philosophy requires a person with experience at all levels of machine tool deployment and uptime management.

"We are now offering several different preventive maintenance programs and spare parts tuneup packages that will improve machine performance and extend uptime," Kelly said. "Neil Sawyer is one of the few people in the U.S. who we felt could launch and manage such an aggressive program."

## Timken and Axicon Team Up To Pursue Advanced Gearing Solutions

The Timken Co. of Canton, OH, has teamed with Axicon Technologies Inc. of Pittsburgh, PA, to pursue advanced gearing solutions for automotive and industrial applications that address customers' unmet needs.

According to a press release, the companies will pursue opportunities to pro-

# TRU-VOLUTE® Gear Cutting Tools

Proven reliability and unsurpassed accuracy are why we've remained a leader in the gear tool business for over 50 years.

- ✓ Extensive Stock - All Bore Sizes
- ✓ FREE CATALOG
- ✓ Diametral & Module Pitches
- ✓ SOLID CARBIDE HOBS
- ✓ Express Delivery
- ✓ TRU-VOLUTE® Class AAA
- ✓ Latest Coating Technology
- ✓ Quick Quotes



**RUSSELL,  
HOLBROOK  
& HENDERSON, INC.**

Subsidiary of Ogasawara Precision Hob Lab., Ltd. Japan

**Phone: 201-670-4220**  
**Fax: 201-670-4266**  
2 North Street, Waldwick,  
New Jersey 07463

Visit us at: <http://www.tru-volute.com> • Email: [sales@tru-volute.com](mailto:sales@tru-volute.com)

VISIT US AT GEAR EXPO BOOTH #471.

CIRCLE 142

## THE GEAR INDUSTRY HOME PAGE

[www.geartechnology.com](http://www.geartechnology.com)

- BUYER'S GUIDE
- Gear Manufacturing & Testing Machines
- Non-Gear Machine Tools
- Cutting Tools & Accessories
- Services
- Research & Education Links
- A-Z Company Directory
- Literature Mart
- Advertising Information



Welcome to *Gear Technology*, the world's premier technical journal for the design, testing and manufacture of gears, gear drives and geared components. Get information on current, past and future issues of the magazine. Also find staff information.

FREE SUBSCRIPTIONS: USA or OUTSIDE USA

- GET FREE LISTINGS in our Buyers Guide on CD-ROM
- Visit SHOW CENTRAL to learn about Gear Expo 2001!
- Learn how to reach the gear industry in print or online with our advertising kit.
- Gear Industry Home Page Forums  
Get help with a sticky problem or share your knowledge with others in the Forums.
- Looking for the latest news?
- Subscribe to Gear Technology.

-- Search --

Get the Gear Technology newsletter.

Request Reader Service to the Gear Home of Gear Technology.

**VISIT**

[Powertransmission.com](http://Powertransmission.com)

To find manufacturers of gears and other power transmission components.

More Than 75 Companies Offering Gear-making Machines, Gear Testing Machines, Cutting Tools and Gear-making Services.

Your Cyberdirectory For Gear Industry Companies.

Find Them All On Our Website's Buyers Guide.

**[www.geartechnology.com](http://www.geartechnology.com)**

CIRCLE 301

## INDUSTRY NEWS

vide engineering services, license intellectual property and supply high-performing gearing products that offer customers advantages, such as reduced noise levels and improved sound quality.

"This alliance supports our progression into higher value offerings," said Mark J. Samolczyk, Timken's president of precision steel components. "The move into advanced gearing solutions is a natural extension for the company, enabling Timken to leverage its customer relationships, core technologies and manufacturing expertise."

"Axicon's focus has been on providing technology-based solutions for gear and drive train applications," said Mark T. Wyeth, Axicon's president and chief executive officer. "This alliance will allow Axicon to grow its line of product-based solutions and provide a way for us to be even more responsive to our customers' needs."

### Gleason Works Names a New Vice President

The Gleason Works of Rochester, NY, has promoted Michael P. Kerwin to vice president of its operations there.

Kerwin is now responsible for the operations' engineering and manufacturing activities. An employee since 1965, he most recently served as director of business integration.

**Do you have news to share?**  
Send it to *Gear Technology*,  
P.O. Box 1426,  
Elk Grove, IL 60009,  
or fax it to (847) 437-6618.

#### Tell Us What You Think . . .

If you found this column of interest and/or useful, please circle 307.

If you did not care for this column, circle 308.

If you would like to respond to this or any other article in this edition of *Gear Technology*, please fax your response to the attention of Randy Stott, managing editor, at 847-437-6618 or send e-mail messages to [people@geartechnology.com](mailto:people@geartechnology.com).

## ADVERTISER INDEX

For more information about a product or service advertised in this issue of *Gear Technology*, circle the appropriate number on the Reader Response Card and put the card in the mail.

### TRY OUR RAPID READER RESPONSE SYSTEM!

Go to [www.geartechnology.com/rrr.htm](http://www.geartechnology.com/rrr.htm) to request additional information from any advertiser in this issue. Your request will be sent to the advertiser within 24 hours for super-fast turnaround!

ADVERTISER	READER SERVICE NUMBER	PAGE NUMBER
A/W Systems Co.	116, 182	48, 55
Accurate Specialties Inc.	176	50
AGMA	133, 177	30, 43
American Metal Treating Co.	155	55
Barit International Corp.	136	4
Basic Incorporated Group		53
Bourn & Koch Machine Tool Co.	144	21
Chamfermatic Inc.	146	43
Cincinnati Gear Group	111	49
Contract Machining & Manufacturing	156	55
Dr. Kaiser (S.L. Munson)	125	50
Dura-Bar	158	8
Fässler Corp.	127, 185	19, 27
Frisby P.M.C. Inc.	181	55
<i>The Gear Industry Home Page</i>	301	32, 53
Gear Technology Center, Div. of Mitsubishi International Corp.	175	28-29
Gleason Cutting Tools Corp.	105, 157	BC, 55, 53
The Gleason Works	110	IFC-1, 53
Höfler Maschinenbau GmbH	112	22-23
Hornet GmbH	191	54
Index Technologies Inc.	190	54
Inductoheat	161	16
Inscop Corp.	148	26
Interstate Tool Corp.	160	54
ITW Heartland	119	12
Kapp GmbH	194	6-7
Klingelberg Söhne GmbH	103	14-15
Koepfer America L.L.C.	162	55
Kreiter Geartech	163	55
LeCount Inc.	141	4
Leistriz Corp.	184	49
M&M Precision Systems Corp.	165	10
MicroGear	189	27
Midwest Gear & Tool Inc.	149	33
Midwest Gear Corp.	164	55
Nachi Machining Technology Co.	114	5
Niagara Gear Corp.	166	54, 53
On-Line Services Inc.	188	49
Parker Industries Inc.	151	33
Perry Technology Corp.	134	IBC
<i>powertransmission.com</i>		53
Precision Gage Co. Inc.	122	47
Presrite Corp.	108	44
Process Equipment Co.	130	52
Pro-Gear Co. Inc.	167	54
Purdy Corp.	123	13
Quality Transmission Components	137	24
Raycar Gear & Machine Co.		53
Russell, Holbrook & Henderson	142	32
Schütte TGM L.L.C.	178	50
Star Cutter Co.	132, 169	2, 54
SU America Inc.	107	40
Toolink Engineering	153	21, 54
Transatlantic Connection Inc.	170	55
United Tool Supply	131	51
University of Wisconsin—Milwaukee	154	26

## SPIRAL BEVEL GEARS (Transmissions)



**Spiral & Straight Bevel Gear Manufacturing.**  
Commercial to aircraft quality gearing.  
Spur, helical, splined shafts, internal & external,  
shaved & ground gears. Spiral bevel grinding.  
Midwest Transmissions & Reducers.  
ISO compliant.



**MIDWEST GEAR  
& TOOL INC.**  
12024 E. Nine Mile Road  
Warren, MI 48089

**CONTACT:**  
CRAIG D. ROSS  
(810) 754-8923  
FAX (810) 754-8926

CIRCLE 149

## Parker cutting tools will stand the test of time.



### How Much Will The Wrong Choice Cost You?

An investment up front with a PARKER cutting tool can save you time, deliver peace of mind with precision performance that will last. We invest more in people and technology to keep your business running, which has helped us to build successful sales for 35 years. **We invite you to call and discuss your tooling requirements with us.**



1650 Sycamore Avenue, Bohemia, NY 11716  
1-631-567-1000 • Fax: 1-631-567-1355

Visit us on the Web at: [www.parkerind.com](http://www.parkerind.com) or E-Mail: [sales@parkerind.com](mailto:sales@parkerind.com)

CIRCLE 151

# Stock Distribution Optimization in Fixed Setting Hypoid Pinions

Claude Gosselin, Jack Masseth and Steve Noga

This paper was presented at the 2000 Fall Technical Meeting of the American Gear Manufacturers Association.

Printed with permission of the copyright holder, the American Gear Manufacturers Association, 1500 King Street, Suite 201, Alexandria, Virginia 22314. Copies of the paper are available from the Association.

Statements presented in this paper are those of the authors and may not represent the position or opinion of the American Gear Manufacturers Association.

## Introduction

Face-milled hypoid pinions produced by the three-cut, Fixed Setting system—where roughing is done on one machine and finishing for the concave-OB and convex-IB tooth flanks is done on separate machines with different setups—are still in widespread use today.

The undeveloped machine settings, for the finish and rough cuts, are normally obtained from a TCA program, such as those produced by Gleason and Klingelnberg (Ref.1). During the development process, where the finishing machine settings on the pinion are modified until the desired bearing pattern is obtained, the stock distribution between the roughing and finishing operations may be altered to the point where the finishing cut hardly touches the tooth flank in some areas of the tooth. The machine operators then either decrease the

depth of the roughing operation, in which case an undesired lip or step may be left at the root of the tooth, or decrease the thickness of the finished tooth at the expense of increased backlash.

This paper presents an algorithm used to optimize the stock distribution between the roughing and finishing cuts for spiral bevel and hypoid members cut by the Fixed Setting method. The optimization is based on the surface match algorithm (Ref. 2), where the differences between the roughing and finishing spiral angle, pressure angle and tooth taper are minimized in order to obtain rough and finished tooth flanks that are parallel.

Application results of the optimization are shown. Better stock distribution usually results in:

1. increased tool life for both roughing and finishing tools. Finishing tool life is increased via more uniform and reduced stock for the finishing cutters, and roughing tool life is increased by being able to increase the point width of the roughing cutter;
2. reduced development times—otherwise, both the rough and finish setups must be developed;
3. improved productivity—it may be possible to increase the feeds and speeds with reduced chip loads; and
4. improved tooth fatigue performance due to more uniform fillet radii in the roots.

## Main Nomenclature

- $\bar{N}$  tooth flank normal unit vector
- $\bar{V}_r$  relative speed vector
- $S$  position of a point on the blade edge
- $\alpha_c$  cutter angular position
- $\alpha_3$  work roll angle
- $\Phi$  pressure angle error
- $\Psi$  spiral angle error
- $\zeta$  tooth taper error

## Tooth Cutting Process

The generating process of gear teeth is based on the basic concept of meshing elements between a cutter blade—its rotation represents the shape of one tooth of a theoretical generating gear—and the work itself. The fundamental equation of meshing is:

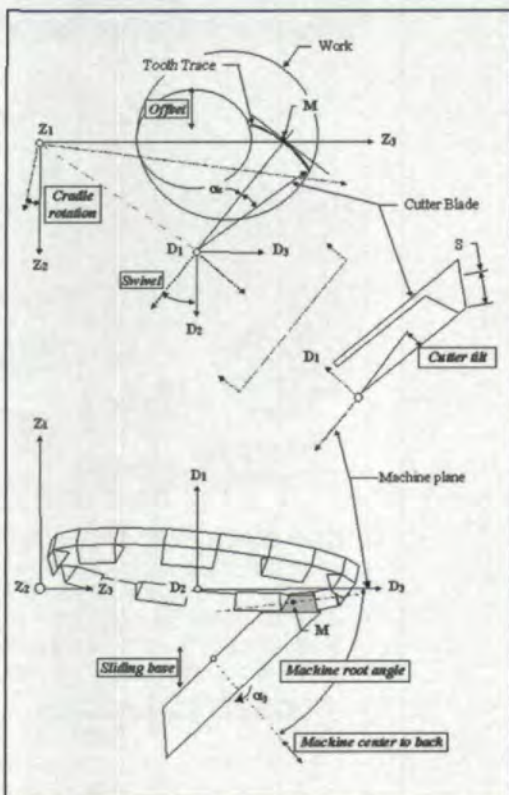

Fig. 1—Reference frames for the simulation of gear manufacturing.

$$\vec{N} \cdot \vec{V}_r = 0 \quad (1)$$

which states that the relative speed vector between contacting surfaces must be in a plane tangent to the meshing surfaces at any contact point.

When applied using the reference frames depicted in Figure 1, Equation 1 yields a generated surface in the reference frame attached to the workpiece. The obtained surface equation is a function of three variables  $\alpha_c$ ,  $\alpha_3$  and  $S$ , respectively the cutter angular position, the work roll angle and the position of a point along the cutter blade edge:

$$S = f(\alpha_c, \alpha_3) \quad (2)$$

The position of any point P on the generated tooth surface is defined by a combination ( $\alpha_c$ ,  $\alpha_3$ ). The solution of Equation 2 is a series of contact points between the cutter blade edge and the work describing a line along the path of the cutter edge defined by its position angle  $\alpha_c$ . The bounded envelope, along the roll angle of the work  $\alpha_3$ , of a series of such lines in the work reference frame X gives a generated pinion tooth such as the one shown in Figure 2. Figure 2 also shows a non-generated gear tooth. A Newton-Raphson iterative method is used to numerically solve Equation 2 (Refs. 3 and 4).

The simulation includes adjustments and movements found in existing generators or Formate/Helixform machines, which can be classified in four categories:

1. cutter helical advance motion, such as that found in non-generating Helixform machines;
2. cutter tilt and swivel angles, shown in Figure 1;
3. work position, normally called offset, sliding base and machine center to back, Figure 1; and
4. decimal ratio, proportional to the ratio of roll between the work and the cradle.

### The Stock Distribution Graph and its Interpretation

The stock distribution is the amount of material that is to be removed at the finishing cut. Ideally, that should be constant over the tooth flank in order to provide adequate performance of the cutting tool. If the tooth taper is duplex, nearly constant stock distribution may be achieved; otherwise, stock distribution may be biased. The Gleason and Klingelnberg TCA softwares initially provide a good stock distribution by properly selecting the roughing machine settings.

In practice, because the roughing and finishing cutter diameters and pressure angles may be different, and because the machine settings may have been modified during the development cycle, stock is not uniformly distributed.

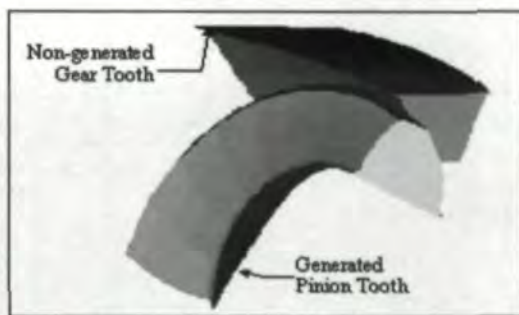

Fig. 2—Meshing pinion and gear teeth.

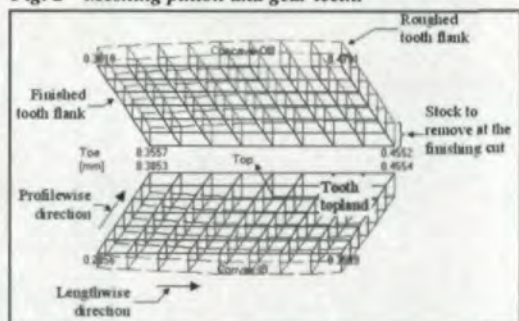

Fig. 3—Stock distribution graph.

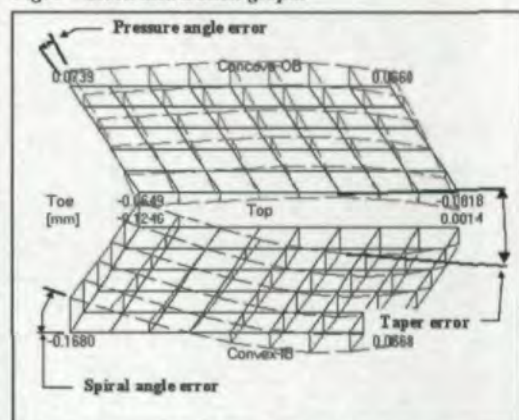

Fig. 4—Common stock distribution errors.

Stock distribution may be shown by two superimposed surfaces. Figure 3 represents the topography of the tooth flank after roughing (solid lines) and finishing (dotted lines).

For clarity, the tooth flanks are unwrapped; thus, the horizontal lines are in the tooth lengthwise direction, the slanted lines are in the tooth profilewise direction, and the vertical lines represent the difference between the roughed and finished tooth flank surfaces.

The differences between the roughed and finished tooth flanks of Figure 3 are called surface error plots and show the error in the direction of the local tooth flank normal vector. The actual differences between the tooth thicknesses of the rough and finished tooth can readily be appreciated.

Each data point gives the local difference between the rough and finished surfaces; global 1st order trends can be observed in the lengthwise and profilewise directions (Figure 4):

- the lengthwise trend depicts an error in spiral angle, which is the average tilt of roughed data

### Claude Gosselin

is a professor of mechanical engineering at Laval University, Quebec. He has written and co-written more than 50 technical papers and conference-proceeding papers on gearing. His research work includes modeling and optimizing the manufacture of spiral-bevel and hypoid gears. He is also president of Involute Simulation Softwares, which produces HyGEARS V 2.0, a program for designing, engineering and analyzing spiral-bevel and hypoid gears.

### Jack Masseth

is chief engineer of the gear engineering department for the Spicer Light Axle Group of Spicer Technologies Inc., a part of Dana Corp. A mechanical engineer, he has 24 years of work experience with bevel and hypoid gears.

### Steve Noga

is a gear engineer with Spicer Light Axle Group. He works in the gear engineering department, which designs and develops bevel and parallel axis gears for the group.

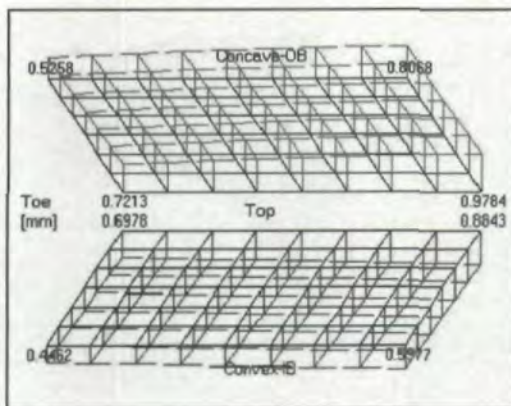

Fig. 5—Basic stock distribution.

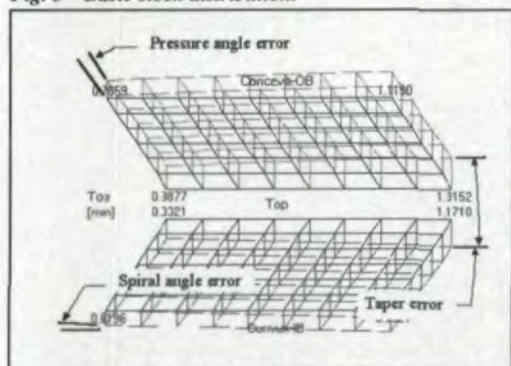

Fig. 6—Change in machine root angle.

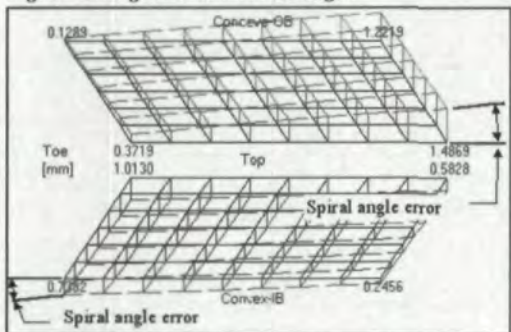

Fig. 7—Change in spiral angle.

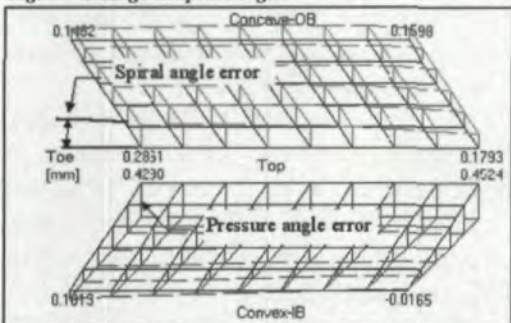

Fig. 8—Change in cutter tilt.

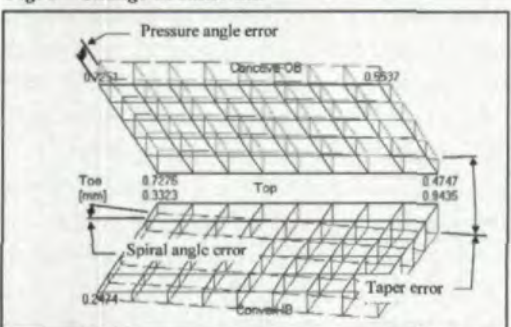

Fig. 9—Change in work offset.

lines relative to the corresponding finished data lines; a crowning error is shown as a curve between the finished and roughed data lines;

- the profilewise trend depicts an error in pressure angle, which is the average tilt of the finished data lines relative to the corresponding roughed data lines; a profile curvature error is shown as a curve between the finished and roughed data lines; and
- taper error is seen as a difference in spiral angle between the IB and OB tooth flanks.

While 2nd order errors may be appreciated in the stock distribution graph, they are neglected in the optimization because of the limited freedom normally available at roughing.

### Error Surface Sensitivity to Machine Setting Changes

The surface match algorithm (Ref. 2), used in this paper to optimize stock distribution, relies on the global response of the error surface to changes in machine settings. This section shows how the error surface may respond to such changes, and global behaviors are established.

In order to demonstrate the sensitivity of the error surface to changes in machine settings, the basic stock distribution of a hypoid pinion is used in Figure 5, which shows negligible pressure, spiral and taper errors.

Figures 6–10 use the same basic stock distribution, except that the roughing machine settings are changed to reflect tooth flank topography modifications. The following machine settings are modified separately: machine root angle, spiral angle, cutter tilt, work offset and machine center to back. For each machine setting change, stock distribution is recalculated and the behavior changes are identified. For any given change in machine setting, the sliding base is modified to keep tooth depth constant at mid-face width.

The actual values in machine setting changes are not reported since the sensitivity of the error surface depends on the actual geometry. Figure 1 may be consulted to link the changes in machine settings to the simulation model.

Figures 6–10 show what are called 1st order changes (Refs. 5–6), e.g. those with minimal curvature or surface twist effects. In Figure 6, the machine root angle is changed; the resulting error surface is a combination of spiral angle error, tooth taper error (spiral angle error difference between the IB and OB tooth flanks), and pressure angle error—all of which can be appreciated through the changes in the corner values of the stock distribution graph.

Modifying the spiral angle, Figure 7, induces spiral angle error; thus the spiral angle will be the

chosen parameter to control spiral angle errors.

Changing cutter tilt, Figure 8, produces a combination of spiral and pressure angle errors.

A change in work offset, Figure 9, produces a combination of spiral angle, tooth taper, lengthwise crowning and pressure angle errors. A slight profile curvature error is also visible.

Likewise, a change in work machine center to back, Figure 10, results in a combination of spiral angle, tooth taper, lengthwise crowning, and pressure angle errors.

From the above, the following conclusions are drawn:

- spiral angle errors are effectively controlled by a change in spiral angle at the mean point, with negligible side effects;
- pressure angle errors may be controlled by changes in cutter tilt, machine root angle, work offset and machine center to back; and
- tooth taper errors may be controlled by changes in machine root angle, work offset and machine center to back.

Figure 11 maps the cross-influences of the machine settings on the error surface. Relative cross-influence sensitivity is not shown since it varies with the actual tooth geometry.

While the effects of changes in some machine settings may appear predictable when used one at a time, combined changes include such error surface side effects that the results cannot be predicted directly.

In the above, it is assumed that tooth thickness between rough and finish is adequate and, therefore, that cutter point width is not changed.

In order to quantify the differences between the rough and finish states of a tooth, the following values are defined:

pressure angle error:

$$\Phi = \frac{\sum_{i=1}^n \left[ \frac{\sum_{j=1}^m \frac{\epsilon_{i,j} - \epsilon_{i,j}}{y_{i,j} - y_{i,j}}}{i} \right]}{j} \quad (3a)$$

spiral angle error:

$$\Psi = \frac{\sum_{i=1}^n \left[ \frac{\sum_{j=1}^m \frac{\epsilon_{i,j} - \epsilon_{i,j}}{x_{i,j} - x_{i,j}}}{j} \right]}{i} \quad (3b)$$

tooth taper error:

$$\zeta = \Psi_{IB} - \Psi_{OB} \quad (3c)$$

where:

- i is the index of row data, along the tooth flank;
- j is the index of column data, across the tooth flank;

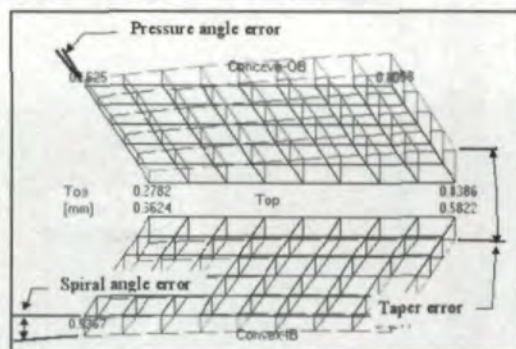

Fig. 10—Change in work machine center to back.

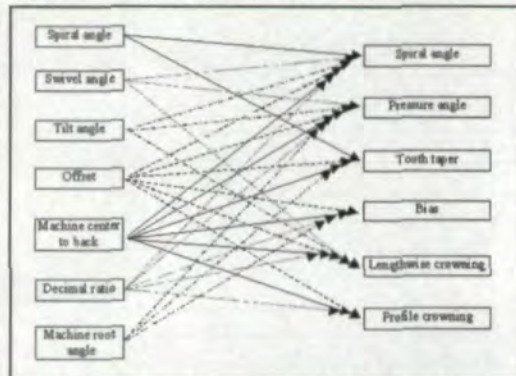

Fig. 11—Mapping of machine settings cross-influences.

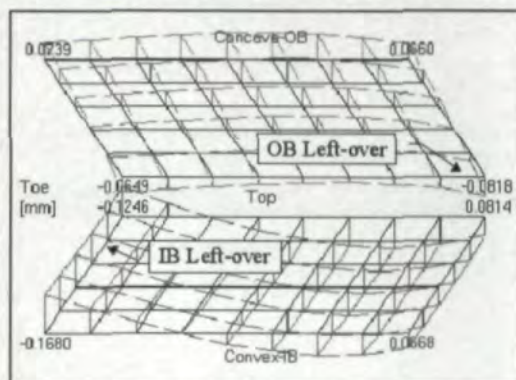

Fig. 12—Stock distribution graph, original roughing settings.

$\epsilon_{i,j}$  is the error value at point  $ij$  of the grid;  
 $x_{i,j}$  is the distance between data points along the tooth flank;  
 $y_{i,j}$  is the distance between data points across the tooth flank.

Equations (3a) to (3c) are used to quantify the differences between the rough and finish tooth surfaces. Whenever the rough surface is changed, the error surface is altered and the above defined quantities are recalculated accordingly.

#### Solution

The objective is to find a combination of machine settings that minimizes the differences in spiral angle, pressure angle and tooth taper between the rough and finish cuts of a tooth.

The solution lies in the use of the response of the error surface—in terms of tooth taper, pressure angle and spiral angle errors—to changes in machine settings while maintaining tooth depth.

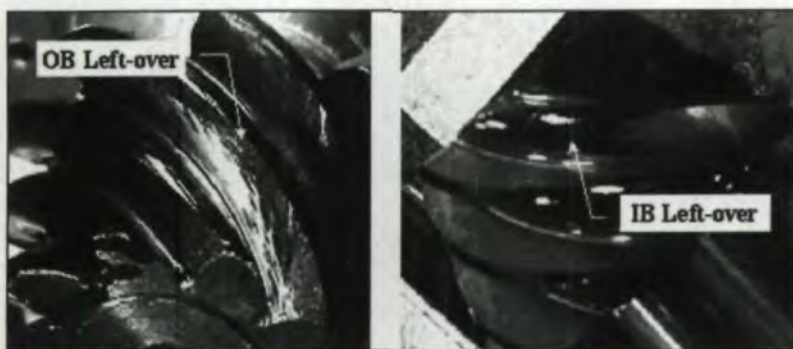

Fig. 13—Actual cut, original roughing settings.

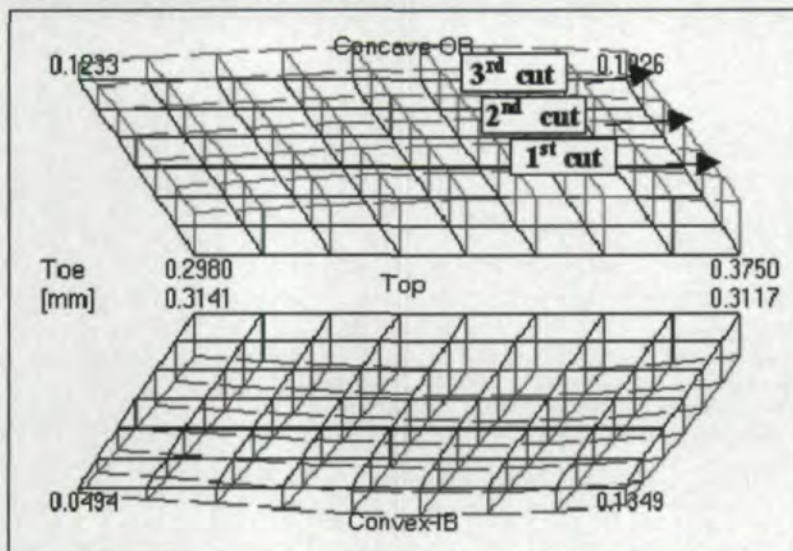

Fig. 14—Stock distribution graph, optimized roughing settings.

Table 1: Original roughing machine settings

Machine Center To Back	:	-0.0419
Sliding Base	:	20.6991
Blank Offset	:	29.5417
Machine Root Angle	:	351.3770
Radial Distance	:	109.3528
Cradle Angle	:	75.4876
Swivel Angle	:	329.7736
Cutter Tilt	:	23.0417
Rate of Roll	:	4.27584

Table 2: Optimized roughing machine settings

Machine Center To Back	:	-0.0656
Sliding Base	:	20.0125
Blank Offset	:	32.3431
Machine Root Angle	:	351.6384
Radial Distance	:	110.4787
Cradle Angle	:	76.1808
Swivel Angle	:	330.4668
Cutter Tilt	:	23.0417
Rate of Roll	:	4.27584

Thus, the following objective functions must be satisfied:

$$\Phi - T_1 \leq L_1 \quad (4)$$

$$\Psi - T_2 \leq L_2 \quad (5)$$

$$\zeta - T_3 \leq L_3 \quad (6)$$

where  $\Phi$  and  $\Psi$  are the averaged pressure and spiral angle errors;  $\zeta$  is the taper error;  $T_1$ ,  $T_2$  and  $T_3$  are desired deviations between the rough and finish cuts; and  $L_1$ ,  $L_2$  and  $L_3$  are the tolerance ranges within which the objective functions can be considered satisfied. In practice, deviations  $T_1$  to  $T_3$  are normally null.

A Newton-Raphson numerical solution is used to solve the above objective functions, where the partial derivatives of the objective functions are calculated in relation to machine setting changes to produce the Jacobian matrix (Eq. 7).

The Jacobian matrix, the sought machine setting changes ( $\Delta P$ s) and the objective functions  $\Phi$ ,  $\Psi$  and  $\zeta$ , form the following systems solved using Gaussian elimination:

$$\begin{pmatrix} \frac{\delta\Phi}{\delta P_1} & \frac{\delta\Phi}{\delta P_2} & \frac{\delta\Phi}{\delta P_3} \\ \frac{\delta\Psi}{\delta P_1} & \frac{\delta\Psi}{\delta P_2} & \frac{\delta\Psi}{\delta P_3} \\ \frac{\delta\zeta}{\delta P_1} & \frac{\delta\zeta}{\delta P_2} & \frac{\delta\zeta}{\delta P_3} \end{pmatrix} \begin{pmatrix} \Delta P_1 \\ \Delta P_2 \\ \Delta P_3 \end{pmatrix} = \begin{pmatrix} -\Phi \\ -\Psi \\ -\zeta \end{pmatrix} \quad (7)$$

#### Application

The algorithm presented above is used to optimize the roughing machine settings of a hypoid pinion. The basic roughing machine settings of the pinion, obtained from a production summary, are given in Table 1. Those were established initially when the tooth geometry was defined using TCA computer software. The bearing pattern was then developed through changes in the finish machine settings.

Figure 12 shows the calculated stock distribution graph for the above pinion, with leftover material at the toe end of the Convex-IB tooth flank and at the tip of the OB-Concave tooth flank, which can clearly be seen after the actual cut in Figure 13. In order to bypass that problem, the machine operator may change the roughing machine settings or increase finishing cutting depth, thereby reducing tooth thickness and introducing an undesired lip or step at the root of the tooth.

Figure 14 shows the optimized stock distribution graph for the pinion in Figure 12. The algorithm was applied to minimize spiral angle, pres-



sure angle and tooth taper errors between the roughed and finished tooth flanks.

The final roughing machine settings, Table 2, show changes in every setting except ratio of roll and cutter tilt.

While stock is not perfectly distributed over the tooth flank, it is vastly improved over the original values without modification to the cutter tool and does not exhibit any clipped area.

Figure 15 shows the progression of stock removal on the Concave-OB tooth flank. Several successive cuts were taken to show where material is first removed in the 1st cut (Figure 14 and Figure 15a) and how removal proceeds in the 2nd cut (Figure 14 and Figure 15b) and in the 3rd cut (Figure 14 and Figure 15c).

Looking at the optimized stock distribution in Figure 14, Concave-OB tooth flank, the three successive cuts are pointed out, and one can see that stock thickness is maximum at tip, towards heel; thus at finishing, that area of the tooth flank should be removed first while the root area at toe will be last. That behavior is clearly seen in Figures 15a, 15b and 15c.

### Conclusion

An algorithm is presented to optimize the stock distribution in the three-cut bevel gear manufacturing process by minimizing the differences between the rough and finished tooth flanks. The algorithm is also applicable to the two-cut process. The algorithm uses the sensitivity of pressure angle, spiral angle and tooth taper errors to machine setting changes—such as spiral angle, machine root angle, cutter tilt, machine center to back and work offset—to calculate the needed machine setting changes to minimize the differences between the rough and finished tooth surfaces.

By optimizing the stock distribution beforehand, machine setup time is reduced substantially, cutter speeds and feeds can be increased and overall cutter life is improved.

### References

1. Shtiplman, B. *Design and Manufacture of Hypoid Gears*, John Wiley & Sons, 1978.
2. Gosselin C., T. Nonaka, Y. Shiono, A. Kubo and T. Tatsuno, "Identification of the Machine Settings of Real Hypoid Gear Tooth Surfaces," *ASME Journal of Mechanical Design*, Vol. 120, September 1998.
3. Cloutier, L. and C. Gosselin, *Kinematic Analysis of Bevel Gears*, ASME paper 84-DET-177, Power Transmission and Gearing Conference, Boston, 11-14 October 1984.
4. Gosselin, C., L. Cloutier and J. Brousseau, "Tooth Contact Analysis of High Conformity Spiral Bevel Gears," *Proceedings of the JSME MPT 1991 Conference*, pgs. 725-730, Hiroshima, November 1991.
5. Krenzer, T.J. *Computer Aided Corrective Machine Settings for Manufacturing Bevel and Hypoid Gears*, AGMA Paper 84FTM4, 1984.
6. Krenzer, T.J. and R. Knebel, *Computer Aided Inspection of Bevel and Hypoid Gears*, SAE Paper 831266, 1983.

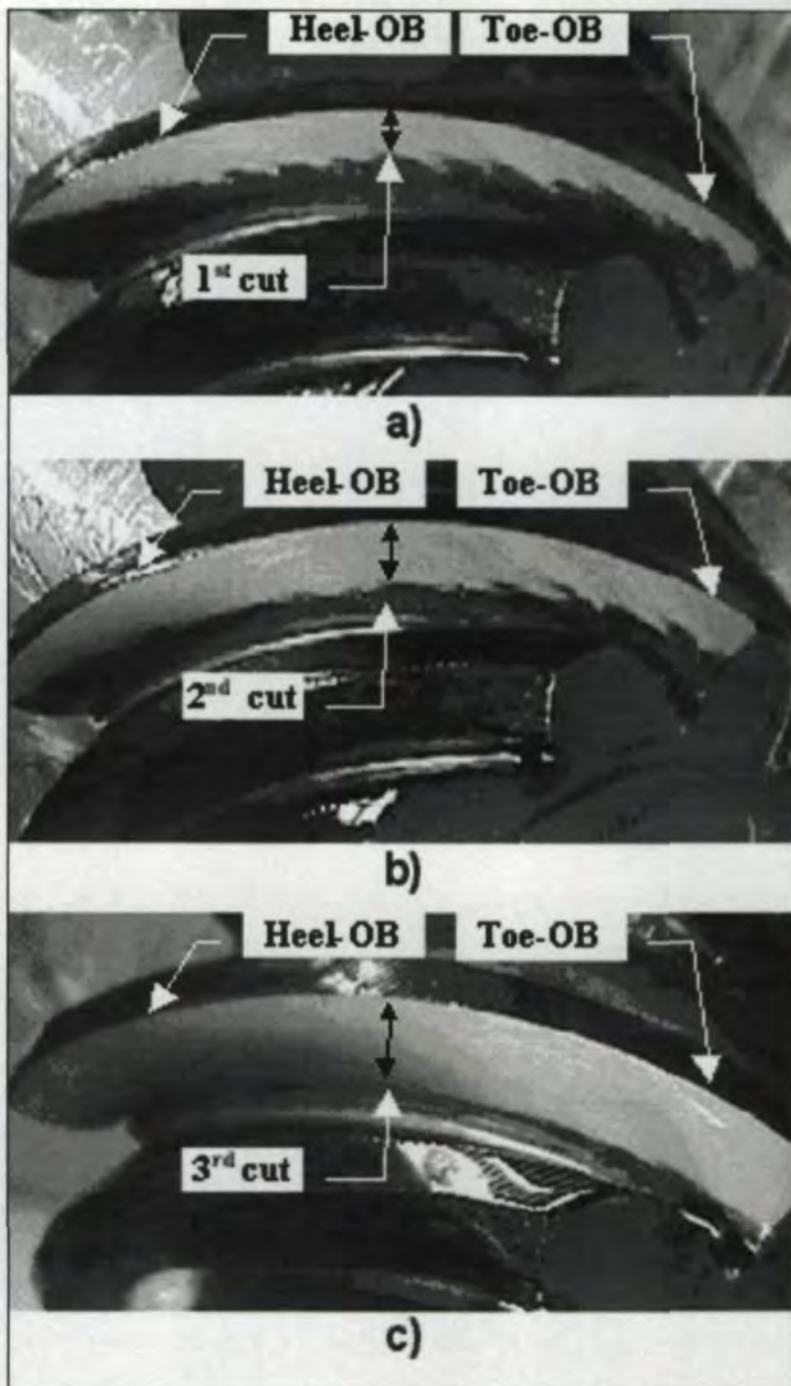

Fig. 15—Progression of stock removal, optimized roughing settings.

### Tell Us What You Think . . .

If you found this article of interest and/or useful, please **circle 319**.

If you did not care for this article, **circle 320**.

If you would like to respond to this or any other article in this edition of *Gear Technology*, please fax your response to the attention of Randy Stott, managing editor, at 847-437-6618.

powered by



**SAMPUTENSILI**



**Solutions for your  
gear manufacturing  
needs.**

**Powered by  
Samputensili.**

CIRCLE 107



Make Samputensili your strong partner for gear technology, quality and service, powered by the will to make your products even better.

We offer you complete solutions for all your gear cutting needs from roughing to finishing.

BVQI  
ISO 9001  
certified

BVQI  
QS 9000 TE  
certified

**SU America Inc.**  
8775 Capital Ave  
Oak Park, MI 48237  
Tel.: +1 248 548-7177  
Fax: +1 248 548-4443  
E-mail: [sales@suamerica.com](mailto:sales@suamerica.com)  
<http://www.samputensili.com>

**VISIT US AT GEAR EXPO BOOTH #112.**

Hobbing – Profile Grinding – Generating Grinding – Shave Grinding – Chamfering – Deburring – Shaving Cutter Grinding  
Bevel Gear Cutting – Tool Services and Commodity Management Services (CMS)

**solutions**

# GEAR EXPO 2001

Gear Expo and Fall Technical Meeting—Together Again!.....	42
Great Expotations?.....	45
Product Preview.....	49

For more information about Gear Expo 2001,  
visit [www.geartechnologyexpo.com](http://www.geartechnologyexpo.com)



# Gear Expo and Fall Technical Meeting— Together Again!

Joseph L. Hazelton



## GEAR EXPO 2001: THE BASICS

**WHO?** Anyone involved or interested in gears and gear manufacturing.

**WHAT?** An international industrial trade show featuring products and services of the gear industry.

**WHERE?** Oakland Hall, Cobo Conference/Exhibition Center, Detroit, MI.

**WHEN?** Oct. 7–10.

**WHY?** To see new and old products and services available to people in the gear industry.

For more information, contact the American Gear Manufacturers Association by telephone at (703) 684-0211, by fax at (703) 684-0242, by e-mail at [gearexpo@agma.org](mailto:gearexpo@agma.org), or on the Internet at [www.agma.org](http://www.agma.org). For information on expo exhibitors and more, visit [www.gearexpo.com](http://www.gearexpo.com) or visit *Show Central* at [www.geartechnologyexpo.com](http://www.geartechnologyexpo.com).

**AGMA** is looking to boost attendance at Gear Expo 2001 and the 2001 Fall Technical Meeting by “cross-pollinating” the two events.

To boost both audiences, the American Gear Manufacturers Association will hold the expo and fall meeting together for the first time since 1993. The meeting is Oct. 3–5, the expo is Oct. 7–10. Both are in Detroit.

“Detroit has always been a good draw for us,” says Kurt Medert, vice president of AGMA’s administrative division and the Gear Expo show manager. The Detroit area is such a good draw because many gear manufacturing companies are in Michigan, supporting the state’s automotive industry.

Medert himself describes Detroit as the expo’s every-other-show home.

As of May 4, more than 160 companies were scheduled to exhibit at the expo. Medert expects almost 200 companies to exhibit in total.

He adds that America’s slowing economy has affected the gear industry and may affect the expo’s attendance, with companies possibly sending fewer people than they usually would.

Still, Medert expects about 4,000–4,500 people to attend the expo—“I would be happy with a number in there.”

The expo is scheduled to have 24 companies that will be first-time exhibitors and more than 20 foreign companies with no U.S. offices.

Medert describes the first-timers as “both domestic and international, large and small.” They’re from France, Germany, India, Italy, South Korea, Taiwan and other countries.

Also, Medert expects this expo to ultimately occupy 60,000 square feet of useable floor space in downtown Detroit’s Cobo Center.

In 1999, the expo occupied 50,000 square feet in the Nashville Convention Center. “That pretty much sold out the hall,” Medert says. This year, the expo is already scheduled to occupy 53,000 square feet in Cobo Center.

Medert adds that AGMA increased this expo’s advertising budget about 40 percent and has “spread the gospel” about the

expo in China, Europe and Mexico.

In Germany, AGMA distributed a multilanguage flyer about the expo to people in late April, at Hannover Fair, the world's largest international industrial trade show. The expo also is being promoted in Europe with help from EUROTRANS, a group of eight European gear and transmission associations.

"We have taken a broader approach internationally," Medert says.

The expo will feature a mix of old and new products and services. "Most companies save a new product or service to debut at our show," Medert says. Exhibitors will include gear manufacturers, material suppliers, cutting tool manufacturers and machine tool manufacturers. "Anyone related to the gear industry."

In Medert's opinion, the expo keeps growing because many visitors are responsible for their companies' purchases.

The expo will be open Oct. 7, from noon to 5 p.m.; Oct. 8 and 9, from 9 a.m. to 5 p.m.; and Oct. 10, from 9 a.m. to 1 p.m.

The expo will offer educational programs, too. AGMA will hold a three-day version of its basic course on gear manufacturing from Oct. 8-10. Also, the Society of Manufacturing Engineers will hold four gear-related seminars Oct. 8-10.

People with questions about the expo can contact AGMA for answers. They can call (703) 684-0211 and ask for Medert or Susan Fentress, can e-mail messages to [gearexpo@agma.org](mailto:gearexpo@agma.org) can fax messages to (703) 684-0242, or can visit [www.agma.org](http://www.agma.org).

Also, AGMA has a new expoWebsite at [www.gearexpo.com](http://www.gearexpo.com), separate from the association's site.

"We feel the show needs to have its own identity," Medert says.

The new Website will provide information on Gear Expo 2001 exhibitors for a year, then will be available for companies exhibiting at Gear Expo 2003. Medert says exhibitors' exposure on the Website will complement their presence at the expo. He adds that AGMA thinks the site will be the best way to promote the current expo and the next one.

For more information on Gear Expo 2001, visit *Show Central* at [www.geartechnologyexpo.com](http://www.geartechnologyexpo.com).

**Joseph L. Hazelton** is Gear Technology's associate editor.

**Tell Us What You Think . . .**

If you found this article of interest and/or useful, please **circle 313**.

If you did not care for this article, **circle 314**.

If you would like to respond to this or any other article in this edition of *Gear Technology*, please fax your response to the attention of Randy Stott, managing editor, at 847-437-6618 or send e-mail messages to [people@geartechnology.com](mailto:people@geartechnology.com).

**The best learning experience in the industry!**

# FTM 2001

**Find answers** to your most complex technical questions.

**Network** with the best minds in the gear industry.

**Hear** new perspectives and solutions from international engineers who are dealing with the same critical issues that you are.

**For more information:**

Visit [www.agma.org](http://www.agma.org) E-mail [tech@agma.org](mailto:tech@agma.org)



AGMA's Fall Technical Meeting  
October 3-5, 2001 • Detroit, Michigan



VISIT US AT GEAR EXPO BOOTH #300.

CIRCLE 177

## CLEAN IT UP!

DEBURR, WASH, DRY, AND RUSTPROOF IN ONE SHORT CYCLE

### CHAMFERMATIC MODEL W.G. 2000

Gear Deburring System	Standard Features:
	<ul style="list-style-type: none"> <li>• Portable</li> <li>• Gear Diameters through 14"</li> <li>• 6" Diameter, 3-Jaw Manual Chuck</li> <li>• P.L.C. with Operator Interface</li> <li>• Automatic Air-operated Door</li> <li>• Built-in Filtration System</li> <li>• Two (2) Deburring Head Assemblies</li> <li>• Two-year Limited Warranty</li> <li>• Work Light Inside Hood Enclosure</li> </ul>
<p><b>Optional Features:</b></p> <ul style="list-style-type: none"> <li>• Additional Deburring Heads</li> <li>• Automatic Air Chucking</li> <li>• Thermostatically Controlled Heating Element</li> </ul>	<div data-bbox="1124 1678 1409 1781" style="border: 1px solid black; padding: 5px; text-align: center;">  </div> <p style="text-align: center;">7842 BURDEN ROAD MACHESNEY PARK, IL 61115 <i>Mike Magee, President</i></p> <p style="text-align: center;"><b>Phone: (815) 636-5082</b> <b>Fax: (815) 636-0075</b> <b>E-mail: <a href="mailto:CHAMFER96@AOL.COM">CHAMFER96@AOL.COM</a></b></p>

VISIT US AT GEAR EXPO BOOTH #481.

CIRCLE 146

# TAKE A BITE OUT OF YOUR GEAR COSTS WITH TEETH LIKE THESE

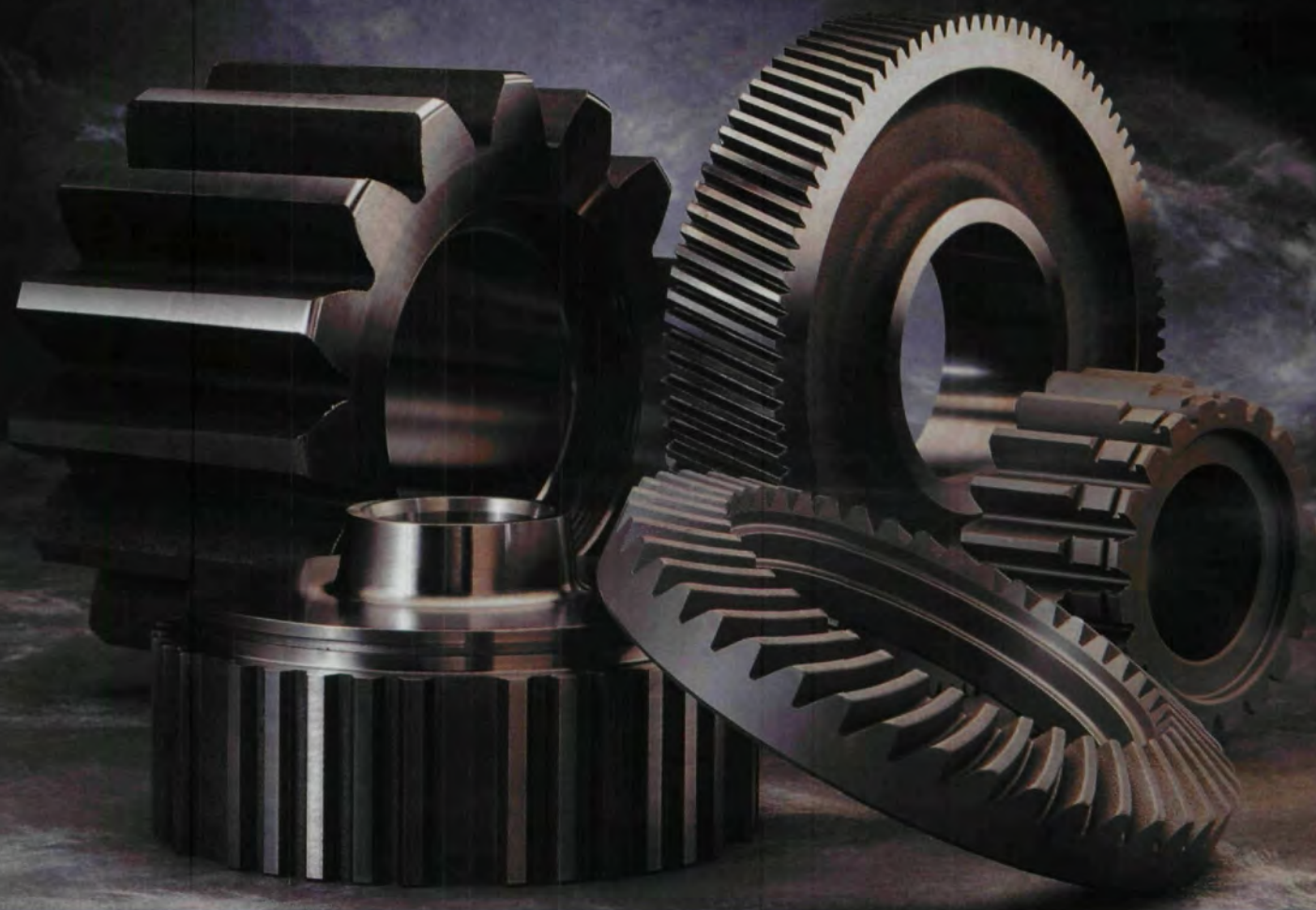

Are you interested in reducing your gear costs while increasing their quality? Presrite hot-forges intricate gears to net and near-net shapes, so little or no hobbing is required.

We've invested millions to save you money and improve the performance of the gears you buy. Our dedicated gear-forging facility is equipped with a state-of-the-art gear lab, high-capacity presses, and the latest in sophisticated machinery.

See why customers from a wide range of industries and countries come to Presrite for forged gears. Contact us now for more information or a quote.

*Weight Savings* — As a blank, this large spur gear weighed 55 lbs. As a forged tooth gear with 1 millimeter of stock on the tooth profile for hobbing, it weighs just 37 lbs.



## PRESRITE NEAR-NET GEARS GIVE YOU THE STRENGTH OF A FORGING WITH LITTLE OR NO MACHINING.

*See For Yourself — Presrite Near-Net Gears Practically Eliminate Rough Cutting!*

*You'll see just how easy it is to hob or grind our forged tooth gears on a Bourn & Koch 200H CNC hobbing machine and 500VG CNC gear grinding machine.*

**BOURN  
& KOCH** MACHINE TOOL CO.

OCTOBER 7-10, 2001  
**Gear  
Expo**  
DETROIT, MICHIGAN

BOOTH NO. 576

An ISO 9002 and QS 9000-Registered Company



Presrite Corporation  
3665 East 78th Street, Cleveland, Ohio 44105  
Phone: (216) 441-5990 • Fax: (216) 441-2644

We're as NEAR as the NET! Visit our Web site at [www.presrite.com](http://www.presrite.com).

# Great Expotations?

*Most Say Economy Won't Put a Damper on the Gear Industry's Big Event*

William R. Stott

Even with some segments of the gear industry facing economic uncertainty, Gear Expo exhibitors and potential visitors are looking forward to this year's show. Instead of focusing on buying and selling, many of those involved with the 2001 show have chosen to focus on the show's value as a marketplace for knowledge.

Recently, *Gear Technology* asked a number of scheduled exhibitors and potential attendees what they expected from this year's show. The responses varied.

Some potential visitors will not be attending the show this year due to budgetary restraints. Others are going with the intention of buying machine tools or finding new suppliers. But the majority of those we spoke with emphasized the importance of Gear Expo as a place to gather information.

Information should abound at what AGMA expects to be the largest Gear Expo ever. According to the list of scheduled exhibitors, it's also going to be more diverse than ever, with all segments of the gear industry represented. As of June



1, those scheduled to exhibit included 50 gear manufacturers, 41 machine tool manufacturers, 15 cutting tool manufacturers, 10 materials suppliers, 10 commercial heat treaters and a number of additional suppliers.

#### Visitors Hungry for Information

William Fuss, president of Hanover Gear of Hanover, PA, is one of those who considers Gear Expo valuable for its information. He's gone to previous Gear Expo shows and once bought a machine tool right off the floor, but his company isn't in the market for machine tools or other suppliers this year. But, Fuss says it's still important for him and 1-3 other people from the company to attend the show. "For us, it's more of a fact-finding

mission," Fuss says, pointing out the importance of staying on top of the emerging technologies. In particular, he says, he'll be looking at metrology and gear shaping technology.

For Fuss, the slow economy isn't a deterrent. "It can't last forever," Fuss says. "When it does break, we'd like to know what's going to keep us at a competitive level."

Gathering information is also important to James M. Wasiloff, who works for the mechanical/structural subsystems department at the automatic transmission engineering operations of Ford Motor Co. in Livonia, MI. "I'd like to see what technology's changing out there—what can be leveraged for our projects here,"

## Hotels for Gear Expo 2001 Participants

For lodging, AGMA has blocks of rooms at four downtown Detroit hotels for Gear Expo 2001 exhibitors and visitors.

The American Gear Manufacturers Association negotiated reduced rates for the hotels for expo participants. The hotels are within walking distance of or are a short ride from Cobo Center.

Expo participants are responsible for making their own reservations at the four hotels. When making reservations, participants should use the telephone and fax numbers listed below and mention the association or the expo to receive the reduced rates. Also, reservations must be made before the cut-off dates listed to insure the availability of rooms.

**Detroit Marriott Renaissance Center** Rate: \$132.00 Single/Double Cut-off Date: Sept. 5

Renaissance Center, Detroit, MI 48243-1003  
Phone: (313) 568-8000 or (800) 352-0831 • Fax: (313) 568-8146

*The Detroit Marriott Renaissance Center is three blocks from Cobo Center and has indoor access to the People Mover, an elevated train system for downtown Detroit that can be ridden to Cobo Center.*

**Crowne Plaza Pontchartrain** Rate: \$112.00 Single/Double Cut-off Date: Sept. 18

2 Washington Blvd., Detroit, MI 48226 • Phone: (313) 965-0200 • Fax: (313) 965-9464

*The Crowne Plaza Pontchartrain is across the street from Cobo Center.*

**Detroit Downtown Courtyard by Marriott** Rate: \$145.00 Single/Double Cut-off Date: Sept. 9

333 E. Jefferson Ave., Detroit, MI 48226 • Phone: (313) 222-7700 or (800) 321-2211 • Fax: (313) 222-8517

*Formerly the Doubletree Hotel, the Detroit Downtown Courtyard by Marriott is near a People Mover station, where people can take a ride to Cobo Center.*

**Atheneum Suite Hotel** Rate: \$177.00 Single/Double Cut-off Date: Sept. 2

1000 Brush Ave., Detroit, MI 48226  
Phone: (313) 962-2323 or (800) 772-2323 • Fax: (313) 962-2424

*Located in Greektown, an ethnic neighborhood, the Atheneum Suite Hotel is near a People Mover station, where people can take a ride to Cobo Center.*

## Marketing in the Gear Industry

*Do you want to learn how to easily reach your customers?  
Do you want your company to be more effective on the Internet?  
Find out how at booth #418 at Gear Expo 2001, October 7-10 in Detroit.*

Randall Publishing, Inc. wants to help you develop marketing solutions that achieve your company's goals. As publisher of *Gear Technology*, the only magazine focusing exclusively on the gear industry, and of the websites [powertransmission.com](http://powertransmission.com)™ and *The Gear Industry Home Page*™, we have extensive knowledge of the gear industry marketplace. We'd like to share that knowledge with you at our booth at Gear Expo 2001.

While we'll explain to you the advertising options available with us, we'll also suggest solutions with other companies. Our consultation is a no-pressure, information-only opportunity to learn from the people at the center of the gear industry marketplace.

### Marketing Solutions

We help all sorts of gear industry companies reach their target markets every day, including:

- Gear job shops and gear drive manufacturers
- Gear machine tool manufacturers
- Gear cutting tool manufacturers
- Inspection equipment manufacturers
- Workholding manufacturers
- Materials suppliers
- Suppliers of services, such as heat treating, consulting and more.

We can give you tips and secrets that have helped many in our industry reach their target markets. Our experts will walk you through:

- How to spread your message for FREE
- How to reach the buyers who need your products and services
- How to get the most out of your advertising dollar
- The importance of consistency
- How to make the most of your technical expertise
- Planning a long-term strategy
- How to know if your ads are working.

**If you're involved in marketing decision-making at your company, visit booth #418.**

**It may be the most important stop you make at Gear Expo.**

**Also, we'll sign you up for a chance to win our one-of-a-kind gear clock, which will be given away at the show!**



says Wasiloff, who will be attending Gear Expo for the first time this year.

Wasiloff's official job title is "6-Sigma Black Belt Candidate." He's one of a group of specialists responsible for helping Ford achieve the company's goal of six-sigma quality. His primary interest is in improving the life of gears in automotive transmissions, and he'll be attending Gear Expo to learn about processes and techniques that could help. "If there is a new process to improve the life of a gear, and it could be demonstrated in one of our robustness programs, it could become a six-sigma project at Ford," Wasiloff says.

#### Exhibitors Eager to Provide Answers

Answering questions for visitors like Wasiloff is of primary interest to many exhibitors. Some of the larger exhibitors will spend hundreds of thousands of dollars exhibiting at Gear Expo. Still, they say they don't expect all visitors to be buyers. In fact, based on their comments, many of the exhibitors seem to welcome information gatherers.

"We're looking forward to customers visiting our booth not just to see the hardware, but we also want customers to bring their problems to us," says Ian Shearing, vice president of sales for Mitsubishi's Gear Technology Center of Wixom, MI.

Mitsubishi will have experts on hand to discuss gear manufacturing challenges, and they'll be able to address any gear or machine problems, including maintenance or service issues, says Shearing.

He adds that Mitsubishi is looking forward to unveiling some new technology, like a synchronized honing machine. The machine is similar to others offered on the marketplace, but it's new for Mitsubishi. On the new machine, the workpiece axis and the honing wheel axis are controlled by separate servomotors. The two axes are timed together to provide improved tooth spacing and lead control in the honing process.

Mitsubishi will also be presenting upgraded technology on its ST40 CNC shaping machine, a model based on the guideless shaper Mitsubishi introduced four years ago. The ST40 comes with a "quick return stroke," which is faster than



the cutting stroke instead of just being an idle stroke. According to Shearing, the quick return stroke saves idle time and makes the machine more productive.

Whether visitors are looking at the machine with current interest or even the slightest future interest isn't important, Shearing says. "Clearly, with the current economic climate, orders are down this year. This is a perfect opportunity to display new technology and expose it to the customers in preparation for the comeback."

The management at Gleason Corp. is also approaching the show with a positive outlook.

"Despite the softening in the economy and the automotive industry, from our perspective, we still see a lot of activity, so we're hoping for a good show," says Mark Hiscock, Gleason's vice president of regional operations for the Americas.

Gleason executives say their focus at the show won't be on sales, anyway. "We don't really go to this trade show, or any other, with the intention of selling off the floor," says Alan R. Finegan, Gleason's manager of market planning & research. Instead, Gleason's goals are more information-based. The company hopes to reinforce its position in the marketplace, strengthen relationships with customers, and unveil new technology, Finegan says.

Finegan wouldn't divulge any specific information about the new technology. He only hinted by saying "We consider it significant," with Hiscock adding that "the cat will be let out of the bag at the show."

Raymond Wagner, vice president of marketing and sales for Nachi Machining Technology Co., also sees the exchange of information as crucial at a show like Gear Expo. "The people who come to trade shows are looking for competitive edges," Wagner says. "They're looking to learn, and they're looking for choices."

The choices being offered by Nachi this year include some incremental advances in technology, including increased manufacturing speed, lower energy consumption, reduction in floor space and improvements in quality, Wagner says.

For example, the newest model of Nachi's vertical roll forming machine,

the PFM610E, is an updated version of the machine shown at IMTS 2000 and Gear Expo 99. The manufacturer has added the "E" to the model to stand for economy and ecology. One of the unique features of the machine is that it can roll parts "semi-dry," using a fine, water-soluble or vegetable oil mist that leaves finished parts with very little oil on them.

Also, Nachi will be focusing on its DuAl brand hobs, which are specially

manufactured and coated to be able to hob dry or with coolant.

#### Even More Knowledge

The show's organizers have also tried to promote Gear Expo as a place for gathering information. The show is scheduled immediately after AGMA's Fall Technical Meeting, which takes place Oct. 3-5 in Detroit. At the meeting, about a dozen technical papers will be presented. In addition, a special session of the

## Yesterday's Reliability Tomorrow's Technology

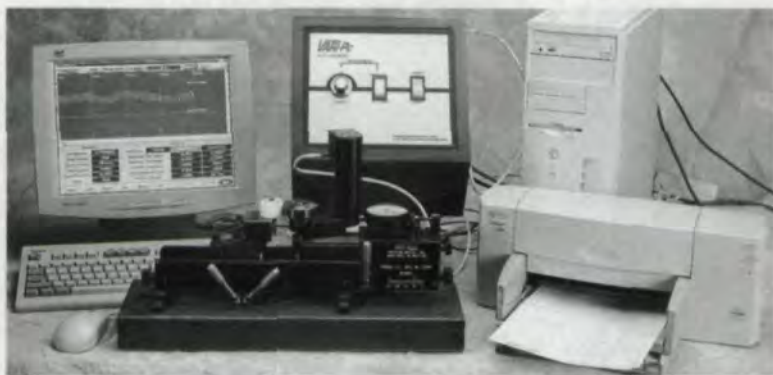

Fifty years of VARI-ROLL applications provide:

- Production Composite Inspection
- Custom Design & Build Part Gear Mounting Fixtures
- Standard Mounting Fixtures — Spurs, Helicals, Pinion Shafts, Worms, Throated Worms, Bevels, Internals

When coupled with the VARI-PC Composite Gear Analysis System will provide:

- Reduced Inspection Cost
- Improved Accuracy
- Historical Record Keeping
- Serialization of Parts
- Interface to SPC programs

Experience the difference. See why customers worldwide have chosen the VARI-ROLL/VARI-PC. For further information, please contact us.

# VARI-ROLL



**Precision Gage Co., Inc.**

100 Shore Drive Burr Ridge, IL 60521  
630-655-2121 Fax 630-655-3073  
www.precisiongageco.com



VISIT US AT GEAR EXPO BOOTH #380.

CIRCLE 122

basic course from AGMA's Training School for Gear Manufacturing will be offered Oct. 8-10. Also, the Society of Manufacturing Engineers is conducting four gear-related seminars at the show. The seminars are: "Gear Metrology" on Oct. 8, "The Preliminary Gear Design Thought Process" on Oct. 9, "Gear Shaping Manufacturing Dynamics" on Oct. 9, and "Advanced Gear Processing and Manufacturing" on Oct. 10.

**Location is Key**

Many people are also encouraged about this year's Gear Expo based on the location in Detroit, which should make it more convenient for the gear industry, which is concentrated in the Midwest.

"It's very difficult to predict what the attendance is going to be," says Shearing. "We're hoping that because of the location that the attendance is going to be good."

Finegan shared similar comments about Detroit. "The location is always key," Finegan said. "For us, the Detroit location is always successful."

John Clare Brennan, manager of clamping technology for Emuge Corp., is also looking forward to the show this year. "I think the Detroit show really has been, in the past, the best of the shows," he says. "This year, we foresee the show with enthusiasm."

Prior to settling on Detroit for the 2001 show, AGMA had been considering holding Gear Expo in Charlotte, NC. After lower-than-expected attendance at Gear Expo 99 in Nashville though, the organizers decided to return to Detroit, where attendance was more favorable in 1997.

While most exhibitors see Detroit's central location as an advantage, some potential visitors attach a stigma to the city, which has struggled in recent years to overcome its negative image. "Detroit's had a lot of rebuilding, but it's still Detroit," says Fuss, who added that he did not attend Gear Expo in 1997 because it was in Detroit.

**Gear Expo Unlike Any Other Show**

Most of the exhibitors and potential visitors we talked to expressed the opinion that Gear Expo is crucial to their businesses. They say the show is unique because no other show focuses exclusively on the gear industry.

Shearing says one of the great advantages of this show over any other is that "everyone who comes into our booth wants to talk about gears."

Wagner echoes this support for Gear Expo. "There's always going to be a place for the AGMA Gear Expo," he says. "Nothing replaces being able to see the metal being cut and talking to people about the technology." ⚙

**Tell Us What You Think . . .**

If you found this column of interest and/or useful, please **circle 330**.

If you did not care for this column, **circle 331**.

If you would like to respond to this or any other article in this edition of *Gear Technology*, please fax your response to the attention of Randy Stott, managing editor, at 847-437-6618 or send an e-mail message to [people@geartechnology.com](mailto:people@geartechnology.com).

**NEW! NOW YOU HAVE ANOTHER CHOICE...**

**and it's made in AMERICA!**



A/W Systems Co. announces that it is now a manufacturing source of spiral gear roughing and finishing cutters and bodies.

We also can manufacture new spiral cutter bodies in diameters of 5" through 12" at present.

A/W can also supply roughing and finishing cutters for most 5"-12" diameter bodies.

Whether it's service or manufacturing, consider us as an alternative source for cutters and bodies.

You'll be in for a pleasant surprise.

**NEW! Straight Bevel Cutters.**

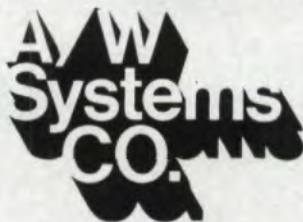

Royal Oak, Michigan 48067  
Tel: (248) 544-3852 • Fax: (248) 544-3922

VISIT US AT GEAR EXPO BOOTH #139.

CIRCLE 116

## Leistritz Corp.

The World Leader in  
Whirling Technology

Booth Number: 709



### Product Line

If the part has a pitch, whirling offers advantages in speed, precision and economy unavailable with any other machining system. Used for production runs of screws, worms, flutes, augers, extruders and more, Leistritz whirling machines produce superior profiles and pitch accuracy, with quick setup and tool-change times, low tooling costs, and mirror finishes. They operate dry, eliminating the high cost of cutting fluids and disposal. Leistritz whirling machines are custom designed to meet demanding specifications and can be conveniently integrated in multimachine cells and systems.

### Company Profile

Leistritz is a world leader in the manufacture of turbine and compressor blades, screw pumps, hydraulic elevators, extruders, and machine tools and tooling. It's headquartered in Nuernberg, Germany, with machine tool manufacturing in nearby Pleystein. Domestic sales and technical support is available from:

# Leistritz

Ralph Wehmann  
Leistritz Corp.  
165 Chestnut Street, Allendale, NJ 07401  
Phone: (201) 934-8262  
www.leistritzcorp.com

Circle 184

## Cincinnati Gear Group

Booth Number: 423

### Product Line

Cincinnati Gear has been designing and manufacturing quality gear components since its founding in 1907. Our extensive design and manufacturing capabilities provide our customers with high-quality, cost-effective components for a wide range of power transmission requirements. State-of-the-art facilities provide customers with the best machinery for cutting, grinding, shaving, shaping, turning, boring and hobbing. Gear inspection is another priority, with workers dedicated to making certain that every gear that leaves our facilities meets the requirements needed. QS 9000/ISO 9001 certified.

Stop by our booth to sign up for our golf club giveaway!

### Capabilities Include:

Turning to 185" O.D.  
Hobbing & Cutting to 220" O.D.  
Tooth Grinding to 158" O.D.  
Welding  
Heat Treating  
Gearbox Inspection & Analysis  
Full-service Field Machining  
Rebuild & Refurbish  
Emergency Repairs



### Contact

Cincinnati Gear Group  
5657 Wooster Pike  
Cincinnati, Ohio 45227  
Tel: (513) 271-7700  
Fax: (513) 271-0049  
E-mail: sales@cintigear.com  
Website: www.cintigear.com

Circle 111

## OLS

Booth Number: 480

### Product Line

OLS offers a wide variety of standard deburring machines, from simple to complex. Our BOB machine (pictured) is an economical, off-the-shelf deburring system that can greatly enhance the productivity of CNC machines by removing the deburring operation from the CNC and letting BOB do it. OLS can also custom configure one of our standard machine bases to meet your deburring needs. The Model 815 base is ideal for high volume production of smaller parts. It is a through-feed machine that is height-adjustable for easy incorporation into an existing or proposed manufacturing cell. The Model 2800 base is ideal for deburring large parts. These bases and others in our inventory may be fitted with the OLS Auto Amp Compensation System, an innovation that provides uniform brush pressure throughout the useful life of the brush, assuring consistent quality. Our design staff can also provide "clean-sheet" custom designs for virtually any part that requires deburring.

### Company Profile

On-Line Services has been manufacturing innovative deburring technologies since 1993. OLS starts with your specifications and applies our knowledge to design and build turn-key systems that deliver high productivity and exceptional quality.



### Contact

# OLS

Eric Mutschler  
3370 West 140th St.  
Cleveland, Ohio 44111  
Phone: (800) DEBURR3  
Fax: (440) 243-6568  
E-mail: eric@olsmachines.com  
Circle 188

## Schütte TGM, L.L.C.

Booth Number: 141

### Product Line

Schütte TGM, L.L.C. introduces the model WU 305 CNC Grinder for the manufacture and grind of both HSS and Carbide Stick Blades. Menu-driven software is provided by Schütte, for the geometry's required, by all Suppliers of Stick Blades. In addition, Pneumatic Clamping is available for all Stick Blade shapes.

We also produce Universal CNC Tool and Cutter Grinders. Grind Stick Blades and high precision rotary, standard and special Cutting Tools, on the same machine.

### Company Profile

Based in Cologne, Germany, Schütte TGM, L.L.C. provides all factory support for North America, from our facility located in Jackson, Michigan.



### Contact

Schütte TGM, L.L.C.,  
4055 Morrill Rd., Jackson, Michigan 49201  
Phone: 517/782-2938 • Fax: 517/782-2940  
E-mail: davidtgm@acd.net  
Website: <http://www.schuttetgm.com>  
Circle 178

## Dr. Kaiser Diamond Dressing Tools

Booth Number: 269

### Product Line

*Dr. Kaiser Diamantwerkzeuge*, located in Celle, Germany, specializes in the design and manufacture of precision rotary diamond dressers for the gear industry. *Dr. Kaiser* precision diamond products are unsurpassed in quality, accuracy, and innovative design.

### Company Profile

*Dr. Kaiser* provides dressing solutions for continuous generating, single tooth, spiral, bevel, gear, and plunge grinding applications in both natural and polycrystalline diamond versions. *Dr. Kaiser* PCD reinforced dressers significantly extend dresser life when compared with standard non-reinforced direct plated dressers, especially in fine-pitch applications. *Dr. Kaiser* offers quick delivery and the highest accuracy at competitive prices. Relapping and replating services are available.

*S.L. Munson & Company* is the exclusive distributor for *Dr. Kaiser* products in North America.



### Contact

S.L. Munson & Company  
401 Huger Street  
Columbia, SC 29201  
Phone: 800-775-1390  
Fax: 803-929-0507  
E-mail: [info@drkaiser.com](mailto:info@drkaiser.com)  
Circle 125

## Accurate Specialties Inc

Booth Number: 427

### Product Line

Bronze components for the power transmission industry. Specialists in gear bronze, producing finish-turned gear blanks, bushings and bearing materials from 1" to more than 48" in diameter. Spun-cast composite gear blanks offer exceptional value, with centrifugal cast components for critical applications and cost-effective production of low quantity orders. Standard tooling often available, or near net shape tooling can be designed to minimize cost and maximize value.

### Company Profile

Accurate Specialties is North America's leading manufacturer of cast bronze gear materials. Innovative and integrated manufacturing capabilities provide you unparalleled service, value and quality through component design, alloy selection, casting and machining. Tin, aluminum and manganese bronzes produced in heats ranging from 200 to thousands of pounds. Our CNC machining and broaching services maximize your throughput and profit by eliminating queue and set-up time wasted on non-core operations at your facility.



**Accurate Specialties Inc**

N12 W24360 Bluemound Road  
Waukesha, Wisconsin 53188-1631  
Phone: (262) 547-5450 • Fax: (262) 547-5892  
E-mail: [sales@accuratespecialties.com](mailto:sales@accuratespecialties.com)  
Circle 176

**Mahr Federal Has  
New Column Gage**

Mahr Federal Inc. has a new measurement device, the Millitron 1840 column gage, with an exclusive feature.

According to a press release, the device's exclusive feature is a bar that can be split so a person can look at actual and dynamic readings or two different measurement results, like diameter and TIR, simultaneously.

The column gage can be used with electronic plug gages/gage rings, inductive probes and pneumatic measuring equipment. Also, it can be configured to work with other manufacturers' probes.

For more information, contact Mahr Federal by telephone at (800) 333-4243 in America and at (401) 784-3100 outside America, by fax at (401) 784-3246, by e-mail at [info@fedprod.com](mailto:info@fedprod.com), or on the Internet at [www.mahr federal.com](http://www.mahr federal.com) or [www.mahr.com](http://www.mahr.com).

Circle 315



**Groschopp Offers New Planetary Reducers With Floating Sun Gears**

Groschopp has new planetary reducers that use floating sun gears instead of fixed-position sun gears.

In a press release, Groschopp design engineer Scott Hulstein said a shaft's fixed-position sun gear will intermittently have more load on one planet gear than on another.

"By allowing the sun gear to float," Holstein said, "it centers itself among the three planets and produces constant, equal load sharing."

He added the floating sun gear provides "true involute action." According to the press release, true involute action occurs when the mating gears' rolling motion is as complete as possible. Groschopp said the motion's completeness lengthens the reducer's life because less internal gear slippage means fewer broken gear teeth, and lowers the reducer's noise levels by reducing the "rattling" as the teeth mesh.

According to the company, the new reducers were designed to compete with parallel shaft reducers and can exceed the torque ratings of similar-sized and larger-sized parallel shaft reducers, while maintaining lower noise levels.

For more information, contact Groschopp at (800) 829-4135, ext. 218 or visit [groschopp.com](http://groschopp.com).

Circle 316

**Unite-A-Matic™  
TRUE DIMENSION GEAR INSPECTION**



Provides actual over ball/pin measurement of any helical or spur gear or spline without the need of costly setting masters.

Provides vital S.P.C. information.

**CAPACITY:**  
9" O.D.  
8" I.D.

Gage Division

**United Tool Supply**

851 OHIO PIKE • CINCINNATI, OHIO 45245 • (513) 752-6000 • FAX (513) 752-5599

CIRCLE 131

**SCHUNK Introduces New Series of Parallel Grippers**

SCHUNK Inc. has a new series of parallel grippers, PGN-plus, with a newly designed jaw guidance, which increases the series' efficiency compared with the standard PGN series.

According to a press release, forces and moments of the gripper—or acting on the gripper—are spread over several surfaces of a multiple-tooth guide, permitting finger length increases of up to 30% and more than doubling the maximum payloads. Also, the fingers' grip force was increased by up to 36% via an optimized piston design.

The series offers five gripper sizes with six versions, each covering a range of gripping forces between 250N and 4,350N.

For more information, contact SCHUNK Inc. by telephone at (800) 772-4865 or (919) 572-2705, by fax at (919) 572-2818 or on the Internet at [www.schunk-usa.com](http://www.schunk-usa.com).

Circle 317



**New Chipless Threading and Profile Rolling Machines**

S&S Machinery Corp. has introduced a new line of chipless threading and chipless profile rolling machines. The machines can produce gears, grooves, hose barbs, knurls, splines, external and internal threads and other profiles.

In a press release, S&S Machinery said the machines were made to meet the needs of users of solid rod and tube. The machines are available in two-roll ver-

sions and three-roll versions and in-feed and thru-feed variations and can include automatic loading and unloading systems.

The machines have a cast frame and square ground slide rails for strength and vibration dampening. The line of six machines consist of five hydraulic machines and one mechanical machine.

For more information, contact Seymour Varady at S&S Machinery Corp. via telephone at (718) 492-7400, via fax at (718) 439-3930, or via e-mail at [sandsmachinery@worldnet.att.net](mailto:sandsmachinery@worldnet.att.net).

Circle 318

**Tell Us What You Think . . .**

If you found this column of interest and/or useful, please circle 325.

If you did not care for this column, circle 326.

If you would like to respond to this or any other article in this edition of *Gear Technology*, please fax your response to the attention of Randy Stott, managing editor, at 847-437-6618 or send e-mail messages to [people@geartechnology.com](mailto:people@geartechnology.com).

*The Next Dimension™* measures tooth alignment, tooth profile, index and root radius relative to other geometric features.

- Volumetrically Mapped Accuracy
- Renishaw™ 3-D Scanning Probe
- Off Axis Correction Capability
- AGMA, DIN, ISO & User defined Analytic Packages
- Software Developed using Microsoft Visual Studio 6.0

*Nurturing Ideas... New Dimensions  
In Gear Technology*

the best of both worlds.

- 3-D measurements
- 2 different worlds
- 1 machine

generative  
measurement



coordinate  
measurement

ND430

**NEXT DIMENSION™**  
Gear Measurement System

**PROCESS**  
Equipment Company

ISO 9001 Registered 4191 US Route 40, Tipp City, OH 45371 • 937-667-7105 800-998-4191 • 937-667-2591 • [gearinspection.com](http://gearinspection.com)

VISIT US AT GEAR EXPO BOOTH #362.

CIRCLE 130

Companies listed below offer product information and design assistance on the World Wide Web. Reach them through home pages listed below.

## GLEASON CUTTING TOOLS CORPORATION

Gleason Cutting Tools Corporation is the leading gear cutting tool manufacturer in North America. We offer a wide variety of form-relieving milling cutters, hobs, shaper cutters, shaving cutters and CBN-plated form grinding wheels as well as our engineering, coating, heat treating, metallurgical, tool sharpening and reconditioning services.



[www.gleason.com](http://www.gleason.com)

## GLEASON

Gleason is the world's most comprehensive resource for gear manufacturing technology. We offer a comprehensive gear cutting machine program for every gear hobbing, milling and grinding application for cylindrical and bevel gears. To learn more about our products and services or to find key contact information, see our Web site.



[www.gleason.com](http://www.gleason.com)

## GEAR MACHINE TOOLS

- Machine tool experience since 1937
- Distribution of Gear machines since 1951
- Broad inventory of NEW Gear machines
- Offering 39 models of gear hobbing machines
- Offering 13 models of gear shaping machines
- Offering 20 models of other gears machines



[www.basicmachinetools.com](http://www.basicmachinetools.com)

## NIAGARA GEAR

The Niagara Gear Website details our precision ground spur, helical and pump gears. All our gears are manufactured with the latest gear grinding technology. The web site also provides information on Niagara Gear's complete capabilities to meet your most demanding, close tolerance requirements with fast turnaround.



[www.niagaragear.com](http://www.niagaragear.com)

## RAYCAR GEAR & MACHINE CO.

Raycar is a privately owned company that manufactures many types of gears. We have hobbing, shaping, shaving, tooth chamfering and gear grinding capabilities. All drilling, milling, tapping and I.D. grinding is done in-house, enabling us to make gears more efficiently and economically and to maintain our scheduled delivery dates.



[www.raycargear.com](http://www.raycargear.com)

## THE POWER TRANSMISSION HOME PAGE

With the industry's most comprehensive online buyers guide and focused editorial content, *powertransmission.com*<sup>TM</sup> is the place to find gears, bearings, actuators, and more. *powertransmission.com*<sup>TM</sup> helps manufacturers reach the right buyers and it is the online resource for industry professionals who want to stay on top of current trends and technology in the industry.



[www.powertransmission.com](http://www.powertransmission.com)

## THE GEAR INDUSTRY HOME PAGE

Explore the world of gear manufacturing from your desktop! More companies, expanded product listings and cutting edge articles and features make *The Gear Industry Home Page*<sup>TM</sup> the only online gear manufacturing resource you need for machinery, tooling, service providers, news and articles from around the industry.



[www.geartechnology.com](http://www.geartechnology.com)

## ADVERTISING INFO

Reaching gear industry professionals—the people who design, manufacture, test and buy gears and geared products—has never been easier. Download our complete 2001 Media Kit with advertising rates and editorial schedule. Get the information you need to advertise in print or online.



[www.geartechnology.com/adkit.htm](http://www.geartechnology.com/adkit.htm)

# CLASSIFIED

## HELP WANTED

### REPS WANTED

Exclusive North American distributor of high quality hydraulic expansion workholding devices is looking for established manufacturer's representatives with experience in workholding applications. Knowledge of gear manufacturing industry preferred.

Commission based on experience and volume of sales.

E-mail resume in confidence to:  
[support@toolink-eng.com](mailto:support@toolink-eng.com)

Visit our website at  
[www.toolink-eng.com](http://www.toolink-eng.com) for complete company information.

## WE'RE HIRING

**Gear Machine Repairman** — Experienced troubleshooter for mechanical and hydraulic repairs. Knowledge of electrical systems desirable. No travel.

Friendly work environment at our convenient northwest suburban Chicago location.

Profit sharing, health insurance.



### CADILLAC MACHINERY CO. INC.

1401 Lunt Avenue, Elk Grove, IL 60007

E-mail: [sales@cadillacmachinery.com](mailto:sales@cadillacmachinery.com)

Fax your resume to 847-437-6618.

**Rates**—Line Classified: 1" minimum, \$310. Additional lines \$45 per line (8 lines per inch). Display Classified: 3" minimum: 1X—\$700, 3X—\$650 per insertion, 6X—\$615 per insertion. Additional per inch: 1X—\$240, 3X—\$225 per insertion, 6X—\$215 per insertion. *Gear Technology* will set type to advertiser's layout or design a classified ad at no extra charge. **Payment:** Full payment must accompany classified ads. Send check drawn in U.S. funds on a U.S. bank or Visa/MasterCard/American Express number and expiration date to *Gear Technology*, P.O. Box 1426, Elk Grove Village, IL 60009. **Agency Commission:** No agency commission on classified ads. **Materials Deadline:** Ads must be received by the 20th of the month, two months prior to publication. **Acceptance:** Publisher reserves the right to accept or reject advertisements at his discretion.

## SERVICE

### INTERSTATE TOOL CORP. CLEVELAND, OHIO

CUSTOM ENGINEERED &  
MANUFACTURED CUTTING TOOLS  
ESTABLISHED 1960

FORM RELIEVED & PROFILE GROUND  
MILLING CUTTERS  
GEAR SHAPER & SHAVING CUTTERS  
ALL CLASSES OF HOBS  
HSS. SOLID CARBIDE & CARBIDE TIPPED

WHETHER YOU NEED NEW TOOLS,  
MODIFICATIONS, RESHARPENING,  
REPAIRS OR M&M INSPECTIONS,  
CONTACT US FOR A QUOTE TODAY!

[www.interstatetoolcorp.com](http://www.interstatetoolcorp.com)  
Tel: 216-671-1077 • Fax: 216-671-5431

CIRCLE 160

### GEAR TOOTH GRINDING SERVICES

- Cost effective gear tooth grinding specialists
- Gear manufacturers are our only customers
- Prototype and production quantities
- Capacity to 27.5" P.D., 3.5 D. P.
- Able to match delivery to your requirements
- All service to AGMA standards with Certified Gear Inspection Equipment

### PRO-GEAR COMPANY, INC.

23 Dick Road, Depew, NY 14043  
Toll Free: 877-684-3810 • Fax: 716-684-7717  
E-mail: [progearinc@aol.com](mailto:progearinc@aol.com)

CIRCLE 167

### HOB SHARPENING INDEX TECHNOLOGIES



- AGMA Class AA
- Helical
- Skiving
- Carbide

- up to 1.25 N.D.P. capacity
- recoating & stripping of all coating types
- tool performance analysis
- rapid turnaround

Index Technologies Inc.  
21135 Lorain Road, Fairview Park, Ohio 44126  
Phone: 440-895-4627 (HOBS) Fax: 440-331-0516  
Email: [gallenco@msn.com](mailto:gallenco@msn.com)

CIRCLE 190

### PRECISION GROUND GEARS

- Spur, Helical and Pump Gears to AGMA Class 15
- Featuring the latest grinding and CNC technology including:
  - Reishauer RZ300E Electronic Gear Grinders
  - Gleason TAG 400 CNC, 8-axis High Production Gear Grinder
  - Full CNC Multi-axis Cylindrical Grinding (Internal and External)
  - High Performance CNC Hobbing
- Continuous Process Improvement Utilizing SPC and Quality Planning
- JIT Delivery using Innovative Stocking Programs

800-447-2392  
Fax: 716-874-9003  
[www.niagaragear.com](http://www.niagaragear.com)  
email: [info@niagaragear.com](mailto:info@niagaragear.com)



CIRCLE 166

### HOB SHARPENING SERVICE

### Star Cutter Co.



#### • THIN FILM COATINGS

West Branch Industries  
Subsidiary of Star Cutter Co.  
2083 W. M-55, West Branch, MI 48661  
1-888-Resharp • 1-888-737-4277  
Phone: (989) 345-2865 • FAX: (989) 345-5660

CIRCLE 169

### KISSsoft is now NORA Transmission Software.

Available from Hornet GmbH, NORA is the KISSsoft/Hirnware software package and more.

NORA has calculation modules for:  
gears • tie rods • transmission elements  
shafts • bearings and more

Bevel gears, spur gears, worm gears and more—All calculated to the most current AGMA, ISO, DIN, VDI and HIRN standards.

We sell NORA software and teach your staff to use the software. We calculate your gear, we examine your gear, we design your gear, we manufacture your prototypes, we supply mold inserts for gears.

Hornet—  
The Way To Make Your Product Profitable

Hornet GmbH  
Seewiesenstrasse 90, D-73329 Kuchen, Germany  
Phone: (49) 7331-98-16-46 • Fax: (49) 7331-98-16-47  
E-mail: [info@hornet-gmbh.com](mailto:info@hornet-gmbh.com)  
Website: [www.hornet-gmbh.com](http://www.hornet-gmbh.com)

CIRCLE 191



## SERVICE

### GEAR TOOTH GRINDING SERVICES

*Spur - Helical - Double Helical*

Capacity up to 60.5" O.D., 1 D.P., 29" Stroke. All ground gears certified up to AGMA Class 14+ on Zeiss-Hofler 1602 CMM. Inventory of grinders includes Hofler 800, Hofler 1000, Hofler 1253 Supra, Hofler 1500 and Hofler Nova CNC 1000 (Fully CNC with on-board CMM checker).

#### Kreiter Geartech

2530 Garrow St., Houston, TX 77003  
Phone: 713-237-9793 Fax: 713-237-1209  
Contact: Mr. Willie Whittington  
Visit our Website at  
[www.kreiter-geartech.com](http://www.kreiter-geartech.com)

CIRCLE 163

### HOB SHARPENING

- State-of-the-art CNC sharpening and inspection machines
- Wet grinding with free-cutting CBN or diamond wheels for "Burn free" sharpening of carbide or high speed steel
- Optional recoating and stripping
- Rush service available

#### Koepfer America, LLC



635 Schneider Drive  
South Elgin, IL 60177  
Phone 847-931-4121  
Fax: 847-931-4192  
[sales@koepferamerica.com](mailto:sales@koepferamerica.com)

CIRCLE 162

- BROACH SHARPENING
- HOB SHARPENING
- SHAVING CUTTER GRINDING
- THIN FILM COATING
- CUSTOM HEAT TREAT SERVICE

PICK UP AND DELIVERY IN MANY AREAS

#### Gleason Cutting Tools CORPORATION

1351 Windsor Road, P.O. Box 2950  
Loves Park, IL 61132-2950  
Phone (815) 877-8900  
Fax (815) 877-0264

CIRCLE 157

### Induction Hardening Specialists in Tooth by Tooth Contour Hardening of Internal Spur, helical and bevel gears

Our gear hardening equipment includes 5 NATCO submerged process machines and 5 AJAX CNC-controlled gear scanning machines. Tooth by tooth gear hardening from .5DP-10DP, up to 15 tons, 200" diameter.

#### American Metal Treating Company

Cleveland, Ohio  
Phone: (216) 431-4492 • Fax: (216) 431-1508  
Web: [www.americanmetaltreating.com](http://www.americanmetaltreating.com)  
E-mail: [mark@americanmetaltreating.com](mailto:mark@americanmetaltreating.com)

Breakdown Service Available

CIRCLE 155

### PRODUCTION SPLINE ROLLING CNC MACHINING

- PRODUCTION MACHINING
- PRODUCTION SAWING
- PRECISION SHAFTING
- ISO 9002/QS 9000 CERTIFIED

#### CONTRACT MACHINING & MANUFACTURING

2425 OVER DRIVE  
LEXINGTON, KY 40511  
Phone: 859-253-9700  
Fax: 859-231-7688

CIRCLE 156

### HOB SHARPENING

Frisby PMC, well known for manufacturing Precision, High-Quality Gears, now offers Precision-Ground Hob Sharpening Service for High Speed Steel or Carbide fine pitch hobs.

#### ISO 9002 CERTIFIED



#### Frisby P.M.C., Inc.

1500 Chase Avenue  
Elk Grove Village, IL 60007-4880  
Phone: 847/439-1150  
Fax: 847/439-1164  
Web Address: <http://www.frisby-pmc.com>

CIRCLE 181

### GEAR TOOTH GRINDING

- Spur • Helical
- Herringbone (with groove)
- Capacity up to 63" O.D., 1 D.P., 16" face

AGMA Certification Inspection  
Delivery to Meet Your Requirements

Midwest Gear Corp.  
2182 E. Aurora Rd.  
Twinsburg, OH 44087  
Phone 330-425-4419  
Fax 330-425-8600

Direct your inquiries to  
Ron Humphrey, General Manager  
[ronh@mwgear.com](mailto:ronh@mwgear.com)

CIRCLE 164



### Hirth Couplings

Standard and Custom  
Fast Delivery • Great Prices

Visit our website for data sheets:  
<http://www.tac-inc.com>



#### TRANSATLANTIC CONNECTION, INC.

1438 Collingswood Drive Rockford, IL 61103  
Tel 815-282-6070 • Fax 815-282-4656

CIRCLE 170

### Reconditioned Cutter Bodies \$ Guaranteed Cost Savings \$

A/W Systems can recondition A/W Spiral Bevel Cutter Bodies to 100% like-new condition.

A/W Systems can sharpen Spiral Bevel and Straight Bevel Cutter Blades. Hob and Shaper Cutter sharpening service also available.

PCD and CBN Inserts reconditioned and retipped available.

Rapid turnaround time.  
Most sizes available.  
For information and quote,  
please contact us at the following:

A/W Systems Company  
612 E. Harrison Ave., Royal Oak, MI 48067  
Phone: (248) 544-3852 • Fax: (248) 544-3922

CIRCLE 182

# aMAZEing

## Gear Design

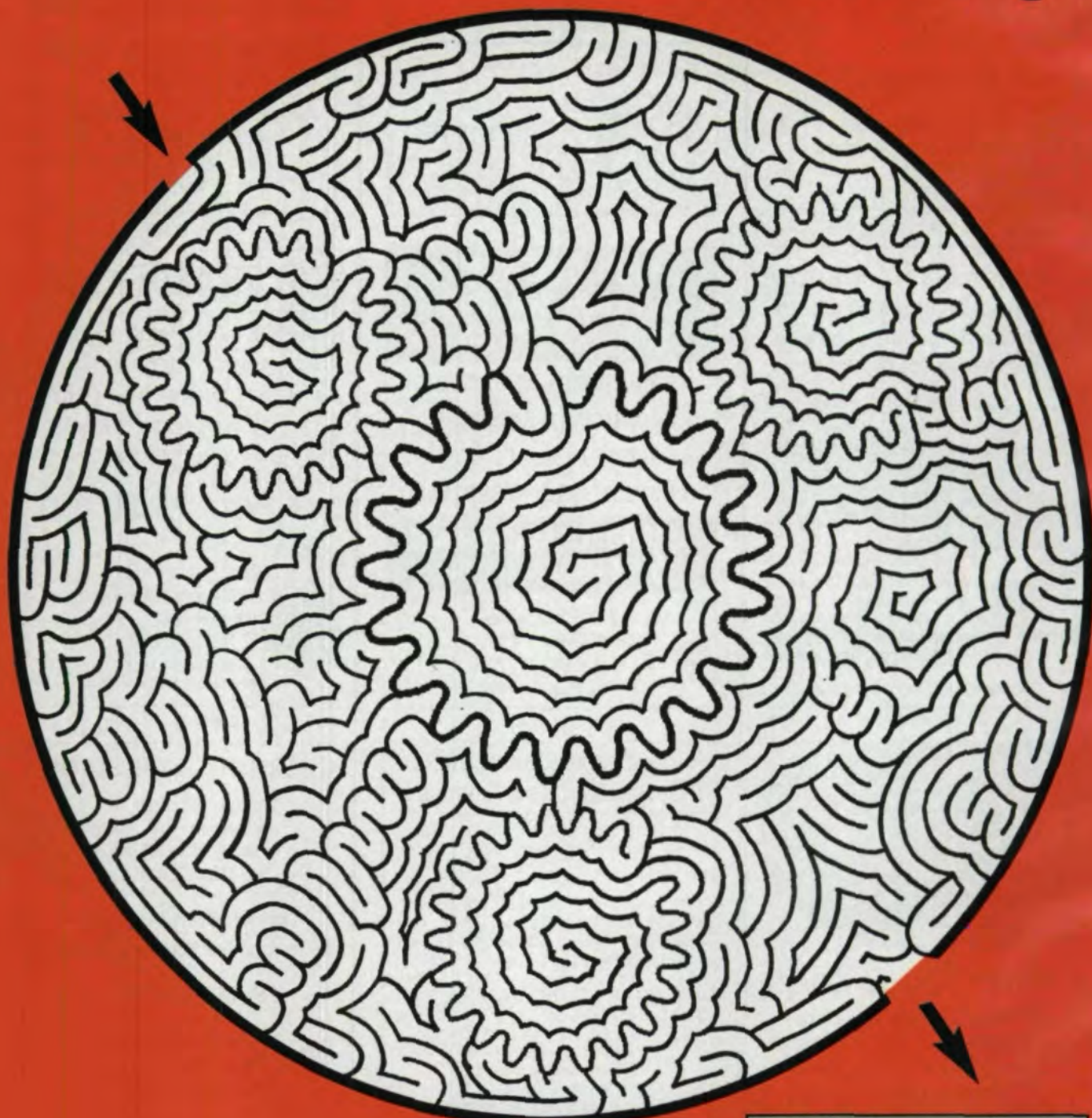

© 2001 Randall Publishing, Inc.

**Tell Us What You Think . . .**  
If you found this article of interest and/or useful, please **circle 340**.  
If you did not care for this article, **circle 341**.

# Hazard?

***NO WAY!***

Stay on par with

**"The Gear & Spline Experts"**



*For all your gear & spline machining requirements, call us today. Our 50,000 square foot, state-of-the-art manufacturing facility combined with an experienced and professional staff of machinists and engineers will be at your service. From fast turnaround prototypes to long running production jobs, you can count on us to help with all your gearing needs.*

*Visit us on-line at [www.perrygear.com](http://www.perrygear.com) to see how we can help.*

**Perry Technology Corporation**  
P.O. Box 21 / 29 Industrial Park Road  
New Hartford, CT. 06057



Phone: (860) 738-2525 - Fax: (860) 738-2455  
E-mail: [sales@perrygear.com](mailto:sales@perrygear.com)

# Gleason Cutting Tools

Looking for revolutionary gear tool technologies to drive down your cost-per-piece? Only Gleason Cutting Tools has all the pieces in place:

◆ The industry's most complete line of hobs, shaper cutters, saw mill cutters, plated CBN wheels, plated diamond rolls, and bevel cutter stick blades.

◆ **POWER CUTTING™** technology, which combines new HSS or carbide materials with advanced coatings, giving users the ability to produce cylindrical and bevel gears at speeds many times that of conventional HSS tools – wet or dry.

◆ On-site services, including advanced coatings, high-performance heat treat, factory regrinds and recoatings, metallurgical lab, grinding wheel plating, and GCT EXPRESS (door-to-door pickup and delivery service for fast, efficient service).

Now making *The Right Choice* has never been easier.

## Gleason Cutting Tools CORPORATION



1351 Windsor Road  
Loves Park, IL 61111 USA  
Web Site: [www.gleason.com](http://www.gleason.com)

Phone: 815-877-8900  
Fax: 815-877-0264  
E-Mail: [Sales@gleason.com](mailto:Sales@gleason.com)

CIRCLE 105

Bevel Gear Cutters

Gear Hobs

Form-Relieved Milling Cutters

POWER LUBE COATINGS

Shaving Cutters

Shaper Cutters

CBN Grinding Wheels

