

DETROIT, MICHIGAN
SHOW • Gear Expo • ISSUE
OCTOBER 20-23, 1991

GEAR TECHNOLOGY

THE JOURNAL OF GEAR MANUFACTURING

SEPTEMBER / OCTOBER 1991



SPC IN GEAR HOBGING & SHAPING
FULL-LOAD TESTING OF LARGE GEAR BOXES
BASIC GEAR GENERATION - DESIGNING THE TEETH

Proven hardware to meet today's SPC gear processing requirements

In every form of gear manufacturing, we keep advancing the technologies for higher productivity and improved quality:

American Pfauter CNC hobbing . . . Lorenz CNC gear shaping . . . Kapp and Pfauter-Kapp grinders and CBN wheels . . . and Pfauter-Maag gear measuring centers. *All* are state-of-the-art, yet *production-proven* for adding superior quality to virtually every type of parallel-axis gear application.

To see these and other leading-edge hardware technologies in action, visit our Gear Technology Center. Just phone us at (708) 640-7500 for arrangements. American Pfauter, 925 Estes Avenue, Elk Grove Village, IL 60007.



See us at Booth #301

 **AMERICAN PFAUTER** LIMITED

CIRCLE A-1 on READER REPLY CARD

Innovative tools for gear cutting and form milling applications

In every type of tooth and thread cutting tool—hobs, shaper cutters, form-relieved milling cutters—we continuously apply advancing technology to produce better, more productive tools.

Example: Our patented Wafer™ Shaper Cutters with disposable blades.

Example: Our high-speed throw-away Wafer™ Hobs.

To see these and other leading-edge technologies in gear cutting tools, visit our Gear Technology Center.

Just phone us at (815) 877-8900 or fax us at (815) 877-0264 for arrangements. Pfauter-Maag Cutting Tools (purchaser of Barber-Colman Gear Tools Division), 1351 Windsor Road, Loves Park, IL 61132.



Pfauter-Maag Cutting Tools

CIRCLE A-4 on READER REPLY CARD



LeCOUNT

EXPANDING MANDRELS



A COMPLETE LINE OF EXPANDING MANDRELS FOR YOUR GEAR INSPECTION NEEDS!

- Unique 3 jaw design
- Greater range of expansion than comparable mandrels
- Guaranteed accuracy of .0001 T.I.R. over entire range of expansion
- Easy to use—workpiece is loaded or unloaded by a light tap

ITW Zero Systems

P.O. Box 509, Midway Drive, Erin, Tennessee 37061

Telephone 1-800-251-4243

Telefax 1-800-242-7142

CIRCLE A-35 on READER REPLY CARD

CONTENTS

SEPTEMBER / OCTOBER, 1991

FEATURES

SPC Acceptance of Gear Hobbing & Shaping Machines

By *Brian Cluff*

American Pfauter, Ltd., Loves Park, IL26

Full-Load Testing of Large Gearboxes ...

By *R. B. Frost*

University of New South Wales

T. R. Cross

John Welsh Pty Ltd., Melbourne, Australia.....35

SPECIAL FEATURES

Gear Fundamentals: Basic Gear Generation - Designing the Teeth

By *Robert Moderow*

ITW, Illinois Tools, Lincolnwood, IL.....40

DEPARTMENTS

AGMA Gear Expo '91

Trade show and technical conference in Detroit.....8

Exhibitor's Index

Advertisers exhibiting at Gear Expo '91.....8

Viewpoint

Our readers respond.....10

Publisher's Page

AGMA Gear Expo '91.....13

Advertiser Index

Find the products and services you need.....16

Shop Floor: Single Flank Testing; H.P. Capacity

By *Robert E. Smith*

Robert Errichello.....17

Management Matters: Taming the Autocratic Boss

By *C. Raymond Rogers*,

Kepner-Tregoe, Inc., Princeton, NJ.....51

Calendar

Events of interest.....60

Classifieds

Products, services, and information you can use.....62



Our cover photo courtesy of Sumitomo Machinery Corp. of America, Chesapeake, VA.

KLINGELNBERG

**Puts it all together
with exciting, new
products to keep
you competitive!**

Gearmakers worldwide face customer demands for highest quality and on-time delivery at fiercely competitive prices. Meeting these demands requires greater flexibility, productivity and the ability to integrate new technology. Recognizing your ultimate goals – customer satisfaction and profitability – Klingelberg global technology is ready with the most advanced CNC Spiral Bevel Gear Generators and Grinders, and the most complete line of CNC Gear Checkers available... anywhere.

We've put it all together:

Spiral Bevel Gear Applications

- KNC 40/60 fully CNC controlled Generators
- AMK Large Gear Generators
- WNC-80 Grinder
- CNC Inspection Equipment
- Quench Presses

Worm and Rotor Grinding Applications

- HNC Series of CNC controlled Grinders
- CNC Inspection Systems

Parallel Axis Gear Applications

- CNC controlled gear Inspection Systems
- SNC Series of CNC Hob Sharpeners
- Gear Cutting Tool Inspection Systems
- Hurth Product Line: CNC Shavers, Hard & Fine Finishers, Shaving Cutter Grinders and Deburring/Chamfering Equipment.

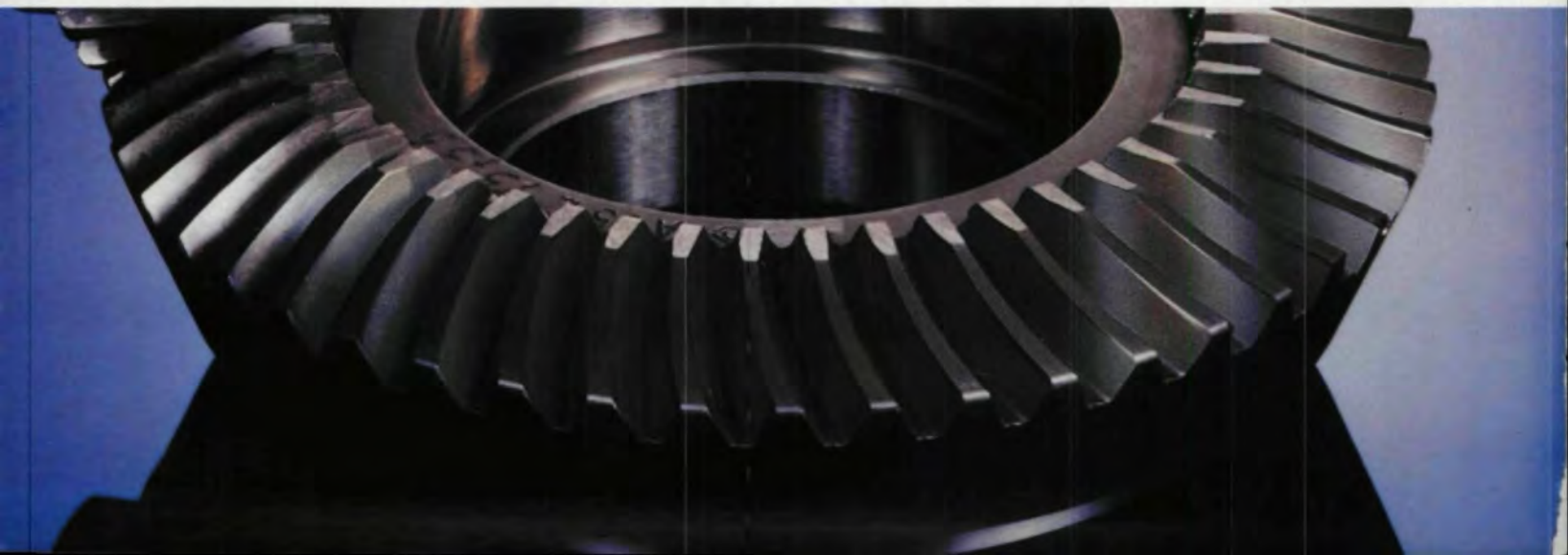

GEARMAKING!

The KNC-40/60 Gear Generators

These new, fully CNC, 8 axis gear generators produce Spiral Bevel Gears up to 24" O.D. Perfect for small batch or intermediate level production runs, the KNC Series generates Spiral Bevel Gears of any geometry by continuous or single indexing operation. Its program storage capacity for 250 different workpieces and unlimited storage capacity with a DNC interface, makes it the most flexible gear generator you can buy.



The WNC-80 Gear Grinder

With leading edge technology, the WNC-80 becomes the universal Spiral Bevel Gear grinder for any gear geometry. Perfect for ground gear quality applications up to 31.5" O.D., the grinder offers great versatility, short set-ups and superior accuracy.



The PNC Series Gear Checkers

Compact, new CNC controlled gear checkers provide fully automatic measuring of gears up to 80" O.D. Fast operation, high accuracy, excellent documentation and a wide variety of software modules, form the perfect gear checking package.



For the latest information on Klingelberg systems that satisfy customer demands, for increased productivity and profitability, contact our representative. Or, write to Klingelberg Gear Technology, Inc., 15200 Foltz Industrial Parkway, Strongsville, OH 44136. Phone: 216/572-2100; FAX: 216/572-0985.



KLINGELBERG

...Puts it all together.

SEE US AT



Booth #101

CIRCLE A-4 on READER REPLY CARD

GEAR TECHNOLOGY

EDITORIAL

Publisher & Editor-in-Chief
Michael Goldstein

Associate Publisher & Managing Editor
Peg Short

Senior Editor **Nancy Bartels**

Publishing Assistant **Kelli R. Hopkins**

Technical Editors
Robert Errichello
William L. Janninck
Don McVittie
Robert E. Smith

ART

Art Director **Jean Sykes**
Art Director **Jennifer Goland**

ADVERTISING

Sales Manager **Patricia Flam**

Sales Coordinator **Mary Michelson**

RANDALL PUBLISHING STAFF

President **Michael Goldstein**

Vice President **Richard Goldstein**

Vice President/General Manager **Peg Short**

Controller **Patrick Nash**

Accounting **Laura Kinnane**

Administrative Coordinator
Deborah Donigan

Art Consultant **Marsha Goldstein**

RANDALL PUBLISHING, INC.

1425 Lunt Avenue
P.O. Box 1426
Elk Grove Village, IL 60007
(708) 437-6604

VOL. 8, NO. 5

GEAR TECHNOLOGY, The Journal of Gear Manufacturing (ISSN 0743-6858) is published bimonthly by Randall Publishing, Inc., 1425 Lunt Avenue, P.O. Box 1426, Elk Grove Village, IL 60007. Subscription rates are: \$40.00 in the U.S.; \$50.00 in Canada; \$55.00 in all other countries. Second-Class postage paid at Arlington Heights, IL, and at additional mailing office. Randall Publishing makes every effort to ensure that the processes described in GEAR TECHNOLOGY conform to sound engineering practice. Neither the authors nor the publisher can be held responsible for injuries sustained while following the procedures described.

Postmaster: Send address changes to GEAR TECHNOLOGY, The Journal of Gear Manufacturing, 1425 Lunt Avenue, P.O. Box 1426, Elk Grove Village, IL 60007.

©Contents copyrighted by RANDALL PUBLISHING, INC., 1991. Articles appearing in GEAR TECHNOLOGY may not be reproduced in whole or in part without the express permission of the publisher or the author.

Close dimensional **Gear Heat Treating** to .001" with Gleason #537 and #36 presses

Metallurgical, Inc.
900 East Hennepin Avenue
Minneapolis, MN 55414
(612) 378-1500
Fax (612) 378-0462

A DIVISION OF
TPS
Thermo Process Systems Inc.

CIRCLE A-5 on READER REPLY CARD

New!

5-AXIS CNC HYPOID TOOL SHARPENER

Sharpens both bodies with integral blades
and stick blades

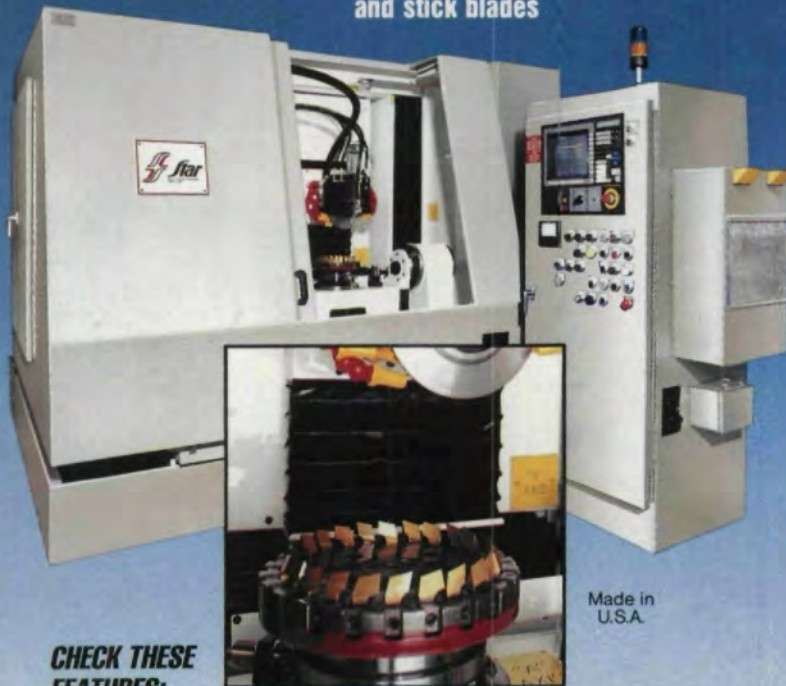

Made in
U.S.A.

CHECK THESE FEATURES:

- ✓ Accuracy - All grinding operations completed in a single step.
- ✓ Full Probing Capabilities - For both part and wheel location.
- ✓ Rapid Setup or Changeover - Bodies to blades, roughing to finishing, other diameters.
- ✓ CBN Wheel - For better surface integrity and finish, longer tool life.

These features result in unprecedented productivity.

CONTACT US FOR FULL DETAILS.



ELK RAPIDS ENGINEERING

Subsidiary of Star Cutter Company

210 Industrial Park Drive • P.O. Box 728 • Elk Rapids, MI 49629
Phone 616/264-5661 • Fax 616/264-5663

VISIT US IN BOOTH 201 AT AGMA EXPO '91

CIRCLE A-6 on READER REPLY CARD

Announcing **Our New Line of Precision Hobs**
**PRODUCES FASTER-RUNNING, QUIETER,
ACCURATE GEARS.**

Precision hobs with a superb surface finish are the result of new production methods now in place at Star Cutter. Hardened hobs are finished by skiving or grinding, depending on hob geometry. The vast majority are skived, providing additional regrind life. The EDM process has been discontinued.

Our new hobs give longer tool life and consistently produce higher quality gears. They accept titanium nitride and other advanced coatings.

CONTACT US FOR DETAILS.



 Since 1927
Star
STARCUT SALES, INC.
23461 Industrial Park Drive
Farmington Hills, MI 48335
313/474-8200 FAX 313/474-9518

CIRCLE A-7 on READER REPLY CARD

We are manufacturers and suppliers of hobs, form-relieved cutters, pressure-coolant reamers, gun drills, tool holders, coatings, and machine tools. We also provide application engineering.

AGMA
Expo '91
Visit us in
Booth 201

Gear Expo '91 Opens in Detroit

Kelli R. Hopkins



AGMA's Gear World of Gearing," Cobo Conference &

Detroit, MI. Gear Expo '91 will provide 35,000 square feet of exhibits by 91 companies from around the world.

Products and processes on display include broaching, custom gears, cutting tool, finishing, forging, grinding, heat treating, hobbing, inspection, lubricating, milling, shaping, shaving, and testing.

Show hours are 12:00 p.m. to 6:00 p.m. on Sunday; 10:00 a.m. to 8:00 p.m. on Monday; 9:00 a.m. to

6:00 p.m. on Tuesday; and 12:00 p.m. to 4:00 p.m. on Wednesday.

Once again the AGMA Fall Technical Meeting

will be held in conjunction with Gear Expo. The FTM will be held on Oct. 23-25 at the Westin Hotel, Renaissance Center, a short distance from the Cobo Center. This year's meeting has been expanded to allow for more presentations. The

papers will feature a variety of gearing subjects, including 3-D contact analysis, gear tooth friction, gear stress distribution, oil jet gear lubrication, and low-noise marine gears.

For more information about either Gear Expo '91 or the Fall Technical Meeting, contact AGMA headquarters at (703) 684-0211. ■

Expo '91, "The opens Oct. 20-23 at Exhibition Center,



Exhibitor Index

Booth No. 717-719-721
AGMA
(703) 684-0211

Booth No. 337
Amarillo Gear Company
(806) 622-1273

Booth No. 137
American Metal Treating Company
(216) 431-4492

Booth No. 101
American Oerlikon
(708) 810-0050

Booth No. 301
American Pfauter L.P.
(815) 877-8900

Booth No. 433
BHS - Hofer Maschinenbau GMBH
Republic of Germany
(07243) 991-0

Booth No. 600
Bourn & Koch Machine Tool Co.
(815) 965-4013

Booth No. 441
Ciateq AC
011 (52) 42 163809

Booth No. 445
Fellows Corporation
(802) 886-8333

Booth No. 604
GMI-Flusa
(708) 986-0756

Booth No. 125
GMI-Mutschler
(708) 986-0756

Booth No. 335
Gear Research Institute
(708) 241-0660

Booth No. 512
Gear Technology
(708) 437-6604

Booth No. 536-538
Guehring Automation Inc.
(414) 246-4994

Booth No. 425
Hofer/IMT Division of Carl Zeiss, Inc.
(612) 533-0225

Booth No. 238
Hommel America
(203) 827-8500

Booth No. 515-614
IIT Research Institute
(312) 567-4000

Booth No. 627
ITW-Illinois Tools
(708) 675-2100

Booth No. 625
ITW-Zero Systems
(708) 867-5857

Booth No. 639
James Engineering
(303) 444-6337

Booth No. 101
Klingelberg Gear Technology, Inc.
(216) 572-2100

Booth No. 241
Koeper America, Inc.
(708) 931-4121

Booth No. 213
M & M Precision Systems
(513) 859-8273

Booth No. 247
Mikron Corp. Elgin
(708) 888-0132

Booth No. 525
Mitsubishi International Corporation
(708) 860-4222

Booth No. 521
Mitts & Merrill
(315) 629-3001

Booth No. 240
Niagara Gear Corporation
(716) 874-3131

Booth No. 225
Normac, Inc.
(704) 684-1002

Booth No. 120-122
Perez Machine Tool Co. (Okamoto)
(716) 688-6982

Booth No. 301
Pfauter-Maag Cutting Tools L.P.
(815) 877-8900

Booth No. 242
Precision Gage Co., Inc.
(312) 586-2121

Booth No. 439
Profile Engineering, Inc.
(802) 885-9176

Booth No. 341
Reef Gear Manufacturing, Inc.
(313) 949-2520

Booth No. 432
Roto Technology, Inc.
(513) 859-8503

Booth No. 644-646
Russell, Holbrook & Henderson, Inc.
(201) 670-4220

Booth No. 549-648
Skidmore Gear Company
(216) 442-6670

Booth No. 201
Starcut Sales, Inc.
(313) 474-8200

Booth No. 347
Tifco, Inc.
(313) 624-7900

Booth No. 718
Tocco, Inc.
(313) 399-8601

Booth No. 606-608-610
United Tool Supply
(513) 752-6000

Booth No. 633
WMW Machinery, Inc.
(914) 358-3330

Booth No. 247
Winterthur
(508) 831-7918

These Gear Expo '91 exhibitors are
Gear Technology advertisers.

KOEPPER

INTRODUCING . . .



MODEL 200 CNC HOBBER

- Seven axis CNC control
- High speed machine design
- Patented automatic skiving system



See us at booth 241



Aerospace quality at an affordable price

KOEPPER

Contact Dennis Gimpert • Koeper America, Inc.
635 Schneider Drive • South Elgin, Illinois 60177
Telephone 708-931-4121 Fax 708-931-4192
Jos. Koeper & Söhne GmbH • Furtwangen, West Germany

CIRCLE A-8 on READER REPLY CARD

A Word In Edgewise



VIEWPOINT

Dear Editor:

Re: Your editorial and "Viewpoint" by Joe Arvin.

Both you and Mr. Arvin make some valid points. Your editorial appears to be a response to Mr. Arvin's "Viewpoint." This is a response to both.

The first point you make is that we cannot depend upon any segment of the government complex to assist in "fixing" the problems of the gear industry. The second point is that the industry must develop its own solutions. And

lastly, I believe, your point is that something must be done.

Mr. Arvin notes the amazing growth of the gear industry in the Asian markets he and the INFAC affiliates visited. He points out that the equipment they saw was at or near "state of the art." He also points out that Asian countries have invested heavily in training and research. Noted too is the fact that less attention seems to be paid to worker safety in some countries. His viewpoint reiterates the posture that company training would put his company at a price disadvantage with his competition.

Much of this is true, but nothing is said as to why these conditions exist. Better understanding of the reasons for these differences should lead to better planning for competitiveness.

In all of the countries mentioned, all government agencies, the banking community, and the industrial complex work in consort to develop and advance their business interests and markets. Some of this is true for many European countries as well. In this country and with our system, not only is this improbable, but illegal. Anyone expecting "a level playing field" within his youngest grandchild's lifetime is an extreme optimist. Understanding this may assist us in developing plans for better posturing.

The previous paragraph leaves "an industry solution," "doing something," and "training and research" to be addressed. I believe that these are virtually the same or so interrelated that I cannot separate them.

It has long been my belief that our

education system needs to be directed toward teaching subjects usable in the working world. I also believe that requires the input of every mom and dad and all industrial leaders. All of us, may need a large club to get the educational community's attention, but involvement is in everyone's best interests.

That tips my hand. I believe that involvement in education, at all levels from primary through graduate, does something toward addressing "industry solutions" through training and research. If training and research costs exceed their payback, then we are teach-

If training and research costs exceed their payback, then we are teaching and studying the wrong things.

ing and studying the wrong things.

While INFAC and the IITRI gear research facility may address some of the education and research needs of the gear industry, they may also prove the terrible state of our machine tool industry. Other social and industrial communities have banded together to produce facilities similar to Phillips Government Training Center and Precision Engineering Institute and have expanded their industrial base and been less sensitive to recession than areas of the country that have done nothing!

Letters for this column should be addressed to: Letters to the Editor, GEAR TECHNOLOGY, P.O. Box 1426, Elk Grove Village, IL 60009. Names will be withheld upon request, however, no anonymous letters will be published.

One additional point I would like to make is that the gear community has not been supportive of American machinery manufacturers and vice versa. Maybe a solution lies in a program similar to that used by various agricultural sectors. They contribute money to support their research and marketing efforts to an industry council that distributes it where they believe it reaps the greatest reward.

What if...every gear manufacturer in America were to put \$.001/pound of gears cut into a Gear Technology Development Fund accumulated and administered by an industry council? The money could be directed to areas of need in the industry: materials research, heat treatment research, tool development, machine development. No Government! No Banks! No Interest! State of the Art American Machine Tools! Materials! Methods! For All!!!

I mean to include everyone cutting gears of all types from the largest to the smallest instrument gear, including the automotive, HD, and agricultural industries...EVERYONE! Some FUNd! Maybe the amount needs to be only \$.0001/per pound! Who knows? Can an industry council that encompasses everyone manufacturing gears be illegal? Is the Beef Council?

Will we let petty differences keep us from arming ourselves to do battle in the world marketplace? If the Asian experience has not taught us enough, are we waiting for the European Economic Community to teach us the rest of the lesson? When will we learn? Has education failed us? Completely?

There is a way to accomplish more than anyone making gears today dreamed possible to a greater extent than imagined! Do we have the resolve? If not this way, there are others. The question remains, "Do we have the resolve?"

Clem Miller
Miller & Associates
Crown Point, IN

ENVIRONMENTAL CONCERNS

In response to concerns for the environment, GEAR TECHNOLOGY no longer uses polybags for its magazines. As a result, some of you have received books that have been badly damaged. We are changing our paper in an effort to make the book more substantial, but we would appreciate hearing from you if you are still having problems. We know many of you save your books as a resource, and we hope that we can come up with a solution that will help you and help the environment. If you receive a badly damaged book, please contact us at 708-437-6604.



result, some of you have received books that have been badly damaged. We are changing our paper in an effort to make the book more substantial, but we would appreciate hearing from you if you are still having problems. We know many of you save your books as a resource, and we hope that we can come up with a solution that will help you and help the environment. If you receive a badly damaged book, please contact us at 708-437-6604.

QUALITY PRECISION WINTERTHUR

SUPERIOR QUALITY, PRECISION GEARS

Demand Superior Quality Grinding Wheels.

Winterthur is a recognized leader in the grinding wheel industry, supplying only the highest quality grinding wheels and technical support to all precision grinding markets. Only Winterthur offers Swiss Precision Grinding Wheels developed to exceed the requirements and demands experienced in grinding gears. At all times, Winterthur stocks a selection of wheels specifically developed for the gear grinding industry. These wheels may be pre-profiled and are available for immediate delivery.

We invite you to experience for yourself the advantages of Winterthur Swiss Precision Grinding Wheels.

Swiss Precision...
Winterthur
continues
the Tradition.

See us at booth #247

WINTERTHUR

WINTERTHUR CORPORATION
Swiss precision grinding wheels

70 James St.
Worcester, MA. 01603
(508) 831-7918 FAX (508) 798-2732

CIRCLE A-10 on READER RESPONSE CARD

M&M Precision Systems . . .

Total Quality in Gear Manufacturing

From Start

Part blank and gear cutting tools play critical roles in gear quality control. We offer optional software packages for inspecting gear blanks for circular geometry and gear cutting tools such as hobs, shaper/shaver cutters, and broaches.

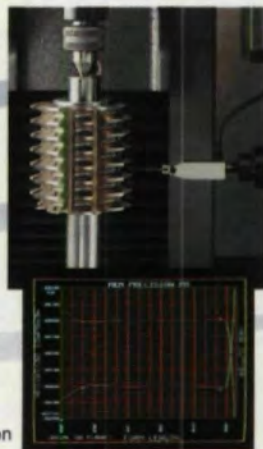

Hob Inspection

Gear Testing using Generative Metrology techniques is enhanced by computerized automation and analysis. True index, lead, and involute testing are performed

as the test part and probe are engaged in inter-related continuous movement. Rotary and linear axis are synchronized as required by the test.

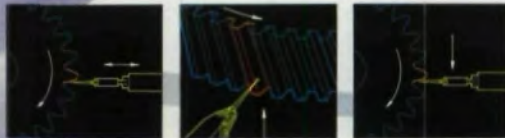

Index

Lead

Involute

Process control can be implemented by analyzing data collected in gear testing. We offer SPC software to evaluate x-bar, R, histogram, and tooth surface topological studies.



Histogram

To Finish

3012-4 QC Gear Analyzer is one of a family of our gear and gear cutting tool analyzers. For a free full-color brochure describing our Gear analyzers, write or call M & M Precision Systems, 300 Progress Rd., West Carrollton, OH 45449, 513/859-8273, FAX 513/859-4452.



See us at Booth #213

M&M PRECISION SYSTEMS

AN ACME-CLEVELAND COMPANY

CIRCLE A-11 on READER REPLY CARD

Come See Us In Detroit

October is the time. Detroit is the place. AGMA Gear Expo '91 is the event. Cobo Center in downtown Detroit is where you will want to be in October if you have any interest in gear products, manufacturing, or research.

Gear Technology will be at Gear Expo '91 too. Come and visit us at Booth No. 512. We look forward to the opportunity to meet with you, our readers and advertisers. Bring us your suggestions and ideas for the magazine, or just stop by for a chat. Find out about how our new readership among people who BUY gears and gear products and our increased circulation can help your sales. If you have an idea for an article or a suggestion for the magazine, this is the place to discuss it. But you don't need an excuse at all. Just drop by to say, "Hello."

Gear Expo '91 will be an exciting place to be. At the time we go to press, ninety-one companies are planning to be there, demonstrating their products and services. The latest in equipment and processes will be on display. If you are planning on buying equipment or are just "tire kicking," this is the place to see what's available in the marketplace.

By taking advantage of AGMA's Fall Technical Meeting, which will be at the Westin Renaissance Center concurrently with the Gear Expo, you and your employees can refresh and update your basic gear knowledge and keep abreast of some of the latest in gear research from some of the best engineering minds in the industry.

This kind of double-barrelled opportunity, targeted directly at the gear industry, shouldn't be missed. If you've ever been lost in the crowd at one of the giant trade shows or spent hours searching for the companies you were interested in, Gear Expo '91 will come as a pleasant surprise.

Its smaller, more intimate size makes for comfortable and friendly fact-finding. Because Gear Expo is devoted exclusively to the gear and gear products industries, the products and services you need are easy to find, and you don't have to fight the crowd to get up close enough to see and hear product presentations and demonstrations.

This the fourth time AGMA has produced a trade show exclusively for our industry. It began as a small table-top adjunct to the Fall Technical Meeting and has grown bigger and better every time since. It is a valuable service, bringing buyers and sellers together under excellent conditions for doing business. It deserves the support of the entire industry.

PUBLISHER'S PAGE



Michael Goldstein - Michael Goldstein,
Publisher/Editor-in-Chief

Evolution. . . .



of Spline Gaging.

3500 BC - Man invents the wheel and says "it is good"
 2500 BC - Man invents the spline and says "it is good"
 2499 BC - Man invents the spline gage and says "it'll do the trick"
 Man has been using the same spline gage ever since. That is, until FRENCO redesigned the gage for modern man. The Frenco indicating spline gage produces variable data on exact Pitch Diameter while simultaneously checking "GO" condition. This SPC compatible gage also quickly checks taper, ovality and other time consuming inspections. Available for internal, external, straight or involute spline configurations.



Let us show you a system for today and beyond. Call or write:

guehring
 AUTOMATION INC

W227 N6193 Sussex Road
 P.O. Box 125 • Sussex, WI 53089
 (414)246-4994 • FAX (414)246-8623



CIRCLE A-35 on READER REPLY CARD

STANDARD UNIT

+

OPTIONAL EQUIPMENT

=

FLEXIBLE SYSTEM

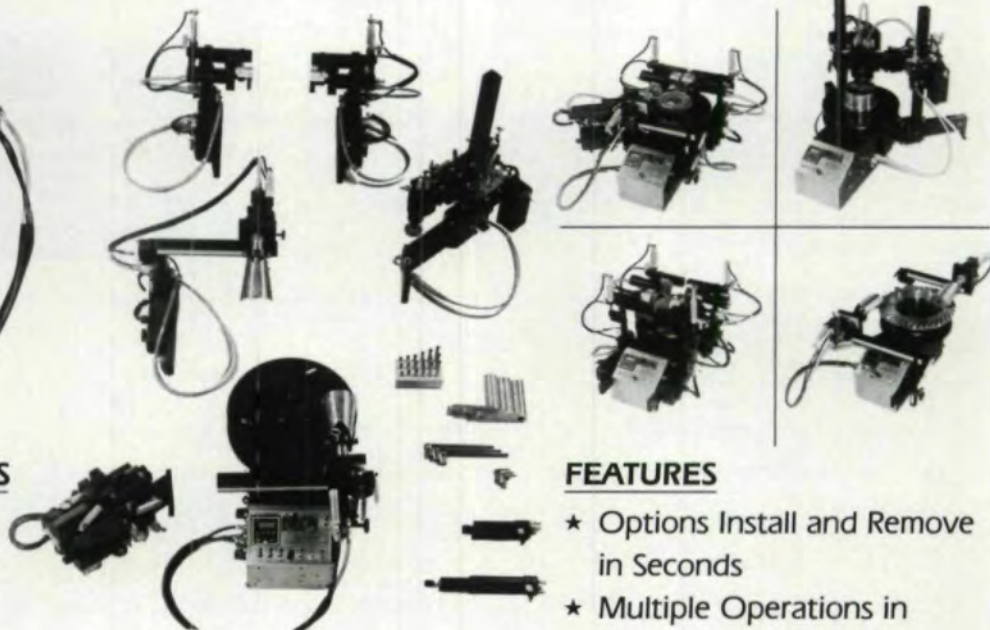

ADDITIONAL OPTIONS

- ★ Dust Collectors
- ★ CNC Controls
- ★ Autoload/unload

FEATURES

- ★ Options Install and Remove in Seconds
- ★ Multiple Operations in One Cycle
- ★ ID/OD Deburring

James Engineering • 11707 McBean Dr. • El Monte, CA 91732 • (818) 442-2898 • Fax (818) 442-0374

CIRCLE A-22 on READER REPLY CARD

Klingelberg ...Geared to Progress

WORLD HEADQUARTERS

KLINGELNBERG SÖHNE
PETERSTRABE 45
D-5609 HUCKESWAGEN
TELEX: 8513196.TEL.(02192)81-1
TELEFAX: (02192)81-200

NORTH AMERICAN HEADQUARTERS

KLINGELNBERG GEAR TECHNOLOGY, INC.
15200 FOLTZ INDUSTRIAL PARKWAY
STRONGSVILLE, OH 44136
PHONE: 216 572-2100
FAX: 216 572-0985

Klingelberg... a tradition of growth. Since its founding in 1814, as a trading company, Klingelberg has combined innovative thinking, consistent reinvestment in the business and new technology to progressively serve the gearmaking industries.

In the early 1920's... the company entered the gear industry. Through technological development and business acquisitions, the company has emerged as an international leader for gearmaking equipment. The product line has grown to include... spiral bevel gear generating and grinding equipment, hob sharpeners, worm and rotor grinders, and a comprehensive line of analytical gear inspection and diagnostic equipment. With the growing reliance on CNC equipment, Klingelberg engineers and computer experts have advanced the cause of automation with innovative designs and software to facilitate faster, more accurate production rates—with sensible price performance ratios.

Our latest development... the joint venture of Oerlikon-Bührle AG (Zurich) with Klingelberg will result in further advances for gearmakers... worldwide.

Collectively, the companies enjoy annual sales exceeding \$150 million with over 1200 employees dedicated to gear industry activities.

Klingelberg "Puts it all together" for gearmakers with...

Spiral Bevel Gear Applications

- KNC 40/60 Fully CNC Controlled Generators
- AMK Large Gear Generators
- WNC-80 Gear Grinders
- CNC Inspection Equipment
- Quench Presses

Worm and Rotor Grinding Applications

- HNC Series of CNC Controlled Grinders
- CNC Inspection Systems

Parallel Axis Gear Applications

- CNC Controlled Gear Inspection Systems
- SNC Series of CNC Hob Sharpeners
- Gear Cutting Tool Inspection Systems
- HURTH product line: CNC Shavers, Hard & Fine Finishers, Shaving Cutter Grinders and Deburring/Chamfering Equipment

GROUND GEAR SPECIALISTS

If you're a Design Engineer, you know the meaning of precision. Miss by a mil and you miss by a mile. Niagara Gear is a contract manufacturer of precision spur, helical and pump gears to AGMA Class 15 with crowning. We are especially proud of our reputation as a Reishauer ground gear specialist. Niagara Gear has quality inspection systems in place to meet MIL-I-45208 and Calibration Standard MIL-STD-45662A. Nital Etch Inspection and Charting are available. Niagara Gear delivers. On price. On quality. And on time. We are as close as a phone call away.



941 Military Road
Buffalo, N.Y. 14217
Phone: (716) 874-3131
Fax: (716) 874-9003

CIRCLE A-12 on READER REPLY CARD



**WE FILL A
LOT MORE
THAN WE
SELL**

GOODWILL INDUSTRIES

WE TRAIN THE BEST WORKERS IN AMERICA.

ADVERTISER INDEX

	Page Number	Reader Service Number
AGMA	49, 54	A-13, A-31
American Metal Treating Co.	62	A-44
American Oerlikon	47, 48	A-63, A-64
American Pfauter, L.P.	cover 2, 62	A-1, A-47
Andrews Products, Inc.	62	A-46
Axicon Gear Company	63	A-51
BHS-Hofler Maschinenbau GMBH	31-34	
Bourn & Koch Machine Tool Co.	39	A-23
California Bevel Gears, Inc.	63	A-49
Ciateq A.C.	18	A-15
Fairlane Gear	54	A-32
Forest City Gear	57	A-17
GMI-Flhusa	61	A-38
GMI-Mutschler	60	A-39
Gear Research Institute	63	A-48
Guehring Automation, Inc.	14	A-35
High Noon	61	A-40
Hofler/IMT Div. of Carl Zeiss, Inc.	21	A-18
Hommel America	50	A-26
ITW-Illinois Tools	64	A-42
ITW Zero Systems	2	A-3
Intercontinental Industries, Inc.	20	A-16
James Engineering	14	A-22
Klingelberg Gear Technology, Inc.	4, 15	A-4, A-24
Koepfer America, Inc.	9	A-8
M & M Precision Systems	12	A-11
Manufactured Gear & Gage	63	A-50
Metallurgical, Inc.	6	A-5
Mikron Corp. Elgin	53	A-29
Mitsubishi Heavy Industries, Inc.	55, cover 4	A-33, A-41
Mitts & Merrill	52	A-27
Niagara Gear	16	A-12
Normac, Inc.	cover 3	A-43
Packer Engineering	63	A-53
Perez Machine Tool Co.	58	A-37
Pfauter Maag Cutting Tools, L.P.	1	A-2
Precision Gage Co., Inc.	62	A-45
Profile Engineering, Inc.	63	A-54
Pro-Gear Company, Inc.	63	A-55
Reef-Baker Corporation	53	A-30
Roto Technology, Inc.	18	A-14
Russell, Holbrook & Henderson, Inc.	46	A-25
Skidmore Gear Company	52	A-28
Starcut Sales, Inc.	6, 7, 22	A-6, A-7, A-19
Tifco, Inc.	63	A-52
Tocco, Inc. (Subsidiary of Park-Ohio Industries, Inc.)	24, 25	A-20, A-21
United Tool Supply	56	A-36
WMW Machinery, Inc.	56	A-9
Winterthur	11	A-10

Single Flank Measuring; Estimating Horsepower Capacity

Robert E. Smith and Robert Errichello

Question: What is functional measurement and what is the best method for getting truthful answers?

The main function of gearing is to transmit uniform rotary motion and power from one shaft to another at the design ratio of the gears. If the gears do not do this, they are said to have transmission error. Therefore, a true functional measurement of gear quality would be one that evaluates errors or variations in terms of uniformity of angular motion. This would be a tangential rather than a radial measurement.

Gear quality measurement is done by either elemental or composite methods. The resulting values are compared to the customer's specification or to some national standard for compliance. Any method used has its advantages and disadvantages.

Elemental. Elemental measurements are made of discrete variations

of gear characteristics, such as pitch, runout, involute, tooth alignment (lead), and tooth thickness. These measurements are typically made by a probe or stylus device that explores part of a tooth or gear.

Composite (Functional). Composite measurements are made by running two gears together (usually one is a master gear) in a manner that simulates unloaded operating conditions. The resulting measurements are a function of a composite of the elemental variations described above.

The advantage of elemental measurement is in diagnostics. Because one is measuring discrete characteristics, it is possible to sort out various causes of any problem.

The elemental method has three disadvantages. The first is that the probe cannot explore all parts of a tooth surface, nor all the teeth; therefore, some errors might be missed. The second is

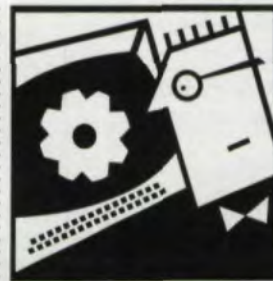

SHOP FLOOR

Address your gearing question to our panel of experts. Write to them care of Shop Floor, Gear Technology, P.O. Box 1426, Elk Grove Village, IL 60009, or call our editorial staff at (708) 437-6604.

Robert E. Smith

is the principal in R.E. Smith & Co., Inc., gear consultants in Rochester, N.Y. He has over 40 years' experience in gearing methods, manufacture, and research.

Robert Errichello

is the principal in GEARTECH, a gear consulting firm in Albany, CA. He is a member of AGMA, ASME, and a Registered Professional Engineer in the State of California.

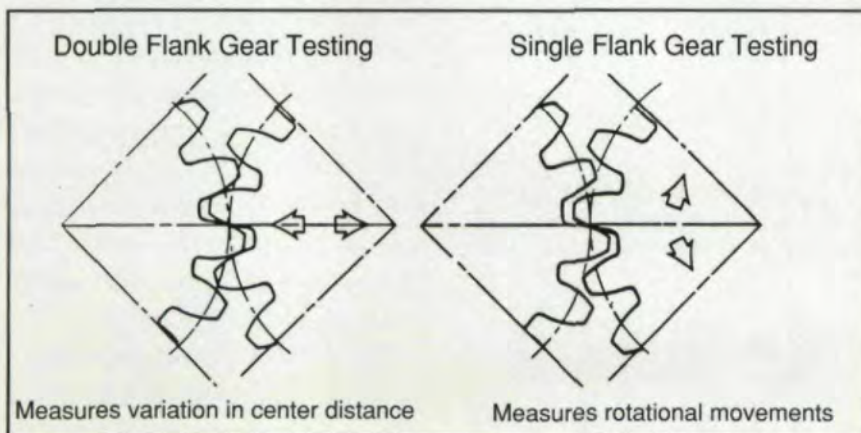

Fig. 1 - Composite gear testing.



GEAR INSPECTION SYSTEM

- 4 FULL 4 AXIS CNC MOVEMENT
- POSITIONING ROTARY 3,600,000 PLACES
- COMPUTER ENHANCED PULL DOWN MENU
- USER FRIENDLY PROGRAM
- TRACEABLE TO NIST
- POWERFUL UNIT COMPACT DESIGN
- HIGH SPEED PRINTER
- COLOR GRAPHIC PLOTTER
- HIGH RESOLUTION CRT
- TWO YEAR WARRANTY

"Accuracy in Millionths"



SPACING/INDEX, LEAD, INVOLUTE PROFILE



CIRCLE A-14 on READER REPLY CARD

GEAR INSPECTION

Table 1 - Comparison of Single & Double Flank Testing Methods

Double Flank Composite (See Fig. 2)

Advantages:

- Inexpensive equipment
 - The best way to measure functional tooth thickness
 - Good way to measure rough hobbled parts that are to be finished by a subsequent operation
 - Fast
 - Durable
- #### Disadvantages:
- Not truly functional (radial measurement)
 - Contacts both sides of teeth (not good for diagnosing involute problems)
 - Doesn't measure accumulated pitch variation (a functional characteristic)
 - Not good for noise control

Single Flank Composite (See Fig. 3)

Advantages

- Truly functional measurement (tangential)
- Good for positional accuracy (accumulated pitch variation)
- Good for measuring involute effects
- Good for noise control

Disadvantages:

- Relatively slow
- Equipment is more expensive and delicate

all in one

NEW

GEAR DESIGN-CALCULATION SOFTWARE

diseng

Is the first gear design software that really designs and not only calculates.

diseng

Is really easy to use in your PC, because it permits achieving high performance results since it is also a research tool for analyzing the influence of each single parameter variation in the results.

diseng

Also has a preliminary dimensioning program presented as a spread sheet.

You'll find us in

How does it work?

FIRST

You define for each parameter, such as ratio, center distance, pressure angle, etc., a convenient set of values that you are really able to use.

SECOND

You define your performance needs regarding Pitting Life, Bending Life, Scoring Probability, Reliability Level and Operating Conditions.

THIRD

You wait a few seconds until **diseng** finds out the best solution to your specific problem within your particular possibilities.



GEAR EXPO
DETROIT, BOOTH # 441

CIRCLE A-15 on READER REPLY CARD

that keeping track mentally of all these discrete measurements to determine what the functional result will be is very difficult. The third drawback of using elemental gear measurement lies with the AGMA standards (AGMA 2000 A-88 and AGMA 390.03a). These standards are tolerances for runout and not accumulated pitch variation. Accumulated pitch variation is a more functional measurement than runout. (See "Shop Floor," Jan/Feb, 1991, *Gear Technology*.) Also, AGMA 2000 A-88 uses a "K" chart evaluation of involute variations. This method isn't necessarily a good control of profile variations for noise problems.

The subject of composite measurement is more complex. To begin with, there are two types of composite measurement: *double flank* and

single flank (transmission error). Unfortunately, the double flank method has been so common in the past that the term "composite measurement" has become almost generic to it.

It is important to understand the difference between these two methods. Perhaps if more people understood the advantages of single flank composite measurement from a functional standpoint, it wouldn't be so rare.

For a comparison, see Fig. 1 and Table 1. Both sides of the meshing teeth are in contact for the double flank method. Only one side is in contact for the single flank method. The important differences are:

1. The double flank method measures variation in center distance, while the single flank method measures variation in rotational movements.

2. Most gears never run with both sides of the teeth in simultaneous contact. Therefore, single flank is the truly functional method.

Question: If single flank measurement is so much better than double

flank, why isn't it used more?

In the past, the technology for single flank testing wasn't readily available. Double flank equipment was simple, inexpensive, and fast, and it's human nature to prefer the easy approach. Single flank testing equipment is a newer technology and is more expensive. Also, tolerances for single flank results do not appear in the AGMA standards.

However, I have used single flank measuring instruments for the manufacture of highly accurate and smooth gears since 1955. It is still one of the first and most important tools in my consulting practice.

The use of this equipment has been more common in foreign countries. Probably no more than 25 systems are in use in the U.S., compared to well over 200 systems elsewhere; yet there are more than 300 company members of AGMA. Almost all of the existing equipment was developed and manufactured in Europe. One such instrument is made in Japan. Another system, developed in England, is now manufactured by an American company. Millions of gears are made every year by

the American automotive manufacturers, and most of them are checked by double flank measuring equipment. Could this be another reason for the decline of the American gear industry?

Some types of gears are difficult to measure with any validity by elemental or double flank techniques. Enveloping worm wheels and bevel gears are among these. Much of the testing is done subjectively by the use of contact patterns. Single flank testing procedures allow quantitative measurement of the functional characteristics of these gear types. Single flank testing can be done on assembled gear trains as well as on loose gears. It is very useful for gears used in printing presses, noise sensitive products, index mechanisms, robots, antenna directors, etc.

The fact that single flank testing is slower than double flank is no longer a valid reason for not using it. With the introduction of statistical techniques, such as SPC, in the American automotive and other industries, the single flank method can be used to test small samples on a regular basis. The trend is to get away from 100% inspection, such as is usually done with double flank measurement.

Question: Isn't it time that the American gear industry gave serious thought to the use of single flank gear testing equipment?

Yes!!!

To address questions to Mr. Robert E. Smith, circle Reader Service No. 78.

Question: We have reconstructed a triple reduction parallel axis gearbox which is driven by a 200 horsepower electric motor. It is used to drive a large screw used in waste processing. We have all of the geometrical data on all three gear sets, teeth, DP, PA, helix angle, face width, center distance, etc. We know the gear materials, which are case car-

SHOP FLOOR

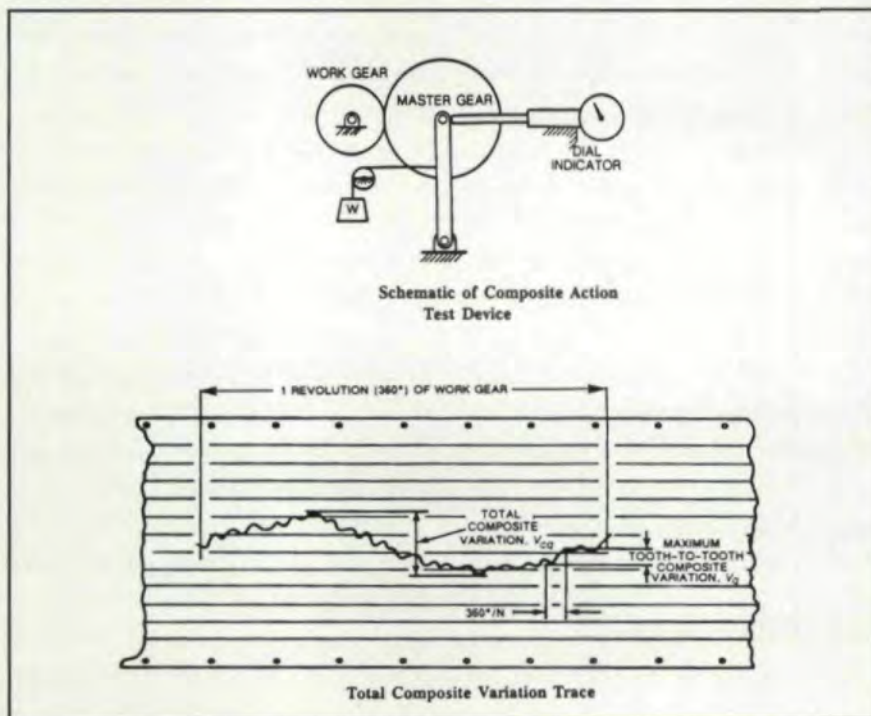

Fig. 2 - Double flank composite action measurement.

GEAR UP! FOR HIGHER QUALITY PRODUCTIVITY PROFITS

MODEL #GS8-2HS
8" Capacity
Gear Shaper

12 Shapers
to choose from
8" TO 98"

Lowest Prices!
Special Orders!
Best Service!

call for
name of rep
in your area



MOVE UP TO

- High Quality, Low Price
- Large Inventory
- Fast Delivery



**HOBS &
CUTTERS**

Gear Shapers, Gear Hobbers, Bevel Gear Generators,
Gear Cutter Sharpeners, Gear Grinders, Cycloid Gear
Millers, Gear Honing Machines, Noise Testers, Inspec-
tion Machines, Hypoid Generators, Gear Shavers,
Gear Tooth Chamferers,
Rack Shapers, Worm
Wheel Hobbers, etc.



over 100
models of
**GEAR
MACHINES**

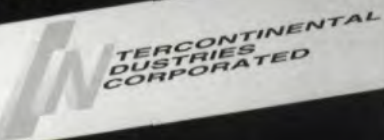

CALL (213) 933-7191

P.O. Box 36276, Los Angeles, CA 90036 • Fax: (213) 933-7487

CIRCLE A-16 on READER REPLY CARD

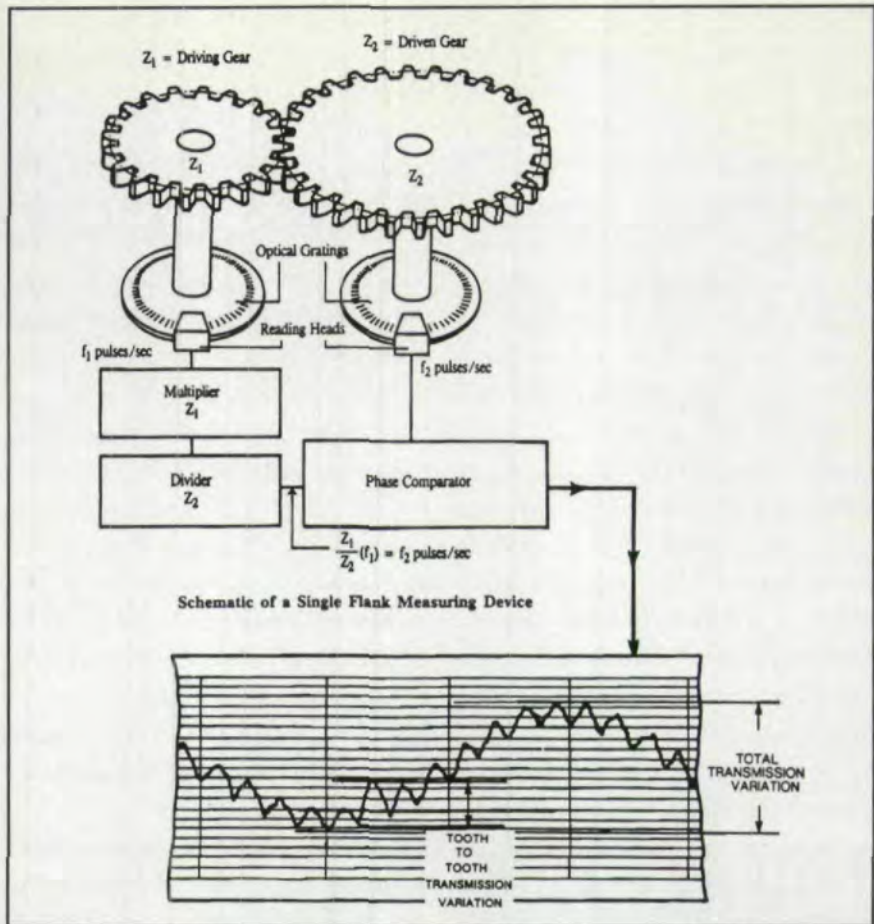

Fig. 3 - Single flank composite action measurement.

burized, and the gears are made to AGMA Q-9 accuracy levels. The input speed is known, and the gears operate under a lubrication system. Is it possible to predict or estimate the horsepower capacity and running hours that can be expected from this box? If so, how?

Parallel-axis gear sets can be rated using the methods described in ANSI/AGMA 2001-B88, American National Standard, "Fundamental Rating Factors and Calculation Methods for Involute Spur and Helical Gear Teeth," and AGMA 6010-E88, American National Standard, "Standard for Spur, Helical, Herringbone, and Bevel Enclosed Drives." These standards give equations for calculating the power capacity of gear sets based on pitting resistance and bending strength. Also, ANSI/AGMA 2001-B88, Appendix A, gives methods for evaluating the risk of scuffing and wear. In addition to the data you mentioned, you will

need the geometry of the tools used to cut the gears in order to calculate the bending strength geometry factors.

The purpose of the standards is to provide common methods for rating gears for differing applications, and to encourage uniformity and consistency between rating practices within the gear industry. Although most of the calculations are straightforward, some of the factors in the equations vary significantly, depending on the application, system effects, gear accuracy, and manufacturing practice. The engineering judgment of an experienced gear designer is required to properly evaluate these factors and obtain realistic ratings.

Software is available for personal computers that automates much of the gear rating task. ■

If you have questions for Mr. Robert Errichello, circle Reader Service No. 79.

It's time to look at Hofler in a different way.



We've added a new dimension in service and support to our advanced 3-D gear-measuring machines.

If you haven't looked at us lately, here's some big news: Hofler CNC gear-measuring machines and software now come from the Industrial Measuring Technology Division of Carl Zeiss, Inc., a world leader in coordinate metrology equipment.

As the gear experts at Zeiss, Hofler is now more responsive than ever. Our full-service locations across the U.S. provide whatever you need—sales, operator training, maintenance or replacement parts.

An extra dimension in speed and precision.

All Hofler machines feature a unique three-

dimensional probe head that allows faster, more accurate testing of profile and lead. Even the simplest Hofler model is more precise than any competing machine in the industry.

Hofler products include the ZME series for cylindrical gears, the EMZ series for universal gear measuring, and the ZMC model for your most demanding laboratory, 3-D and bevel-gear applications. You can also choose from three distinct software packages that run on a networked or stand-alone IBM AT-compatible or Hewlett-Packard computer.

Call today for literature or a demonstration.

1-800-888-1967 Ext. 51

Or see your local Zeiss representative.



Carl Zeiss, Inc.

IMT Division
7008 Northland Drive
Minneapolis, MN 55428
612 • 533 • 0225



HÖFLER

CIRCLE A-18 on READER REPLY CARD

New Hob Production Methods in Place at Star Cutter Company

MANUFACTURE OF PRECISION HOBBS
EMPLOYING NEWLY DEVELOPED TECHNOLOGY IS THE
LATEST STAR INNOVATION.

In response to the demands of the automotive and other industries for faster-running, quieter transmissions under heavier loads, new methods developed at Star now produce precision hobs having a super finish. Hardened hobs are finished by skiving or by grinding, depending on the hob geometry. The vast majority are skived. In the past we finished hobs using an EDM process. This method has been discontinued.

Under this new method all hobs are vacuum heat treated in CNC equipment to ensure extreme accuracy and uniformity. Superior heat treatment is vital to proper application of the new hard finishing technology. Tests show that our new hard finished hobs give longer tool life and consistently produce higher quality gears. Their hard finished surfaces readily accept titanium nitride (TiN) coatings and other advanced coating technologies.

In developing this latest innovation we called on an amazing array of specialized talent and resources. The structuring of our producing units and the people who manage them and work in them are truly specialized. We subscribe to the "one product/one plant" philosophy because we have learned through

the years that quality is higher and production is optimum under this arrangement. We currently manufacture hobs, form relieved cutters, pressure-coolant reamers, and gun drills. All are manufactured under our one product/one plant philosophy. We also operate two coating plants, a carbide preforms facility, and a machine tool manufacturing plant. These autonomous units, strategically located across lower Michigan, funnel their products and services through our sales and service division, StarCut Sales, Inc., located near Detroit in Farmington Hills, Michigan.

Yes, we call on a wide array of talents and resources when we undertake an innovation such as this new hard finished hob production system. The specialized experience of people in all our plants in such disciplines as hard machining, heat treating, coating, CNC, statistical process control, and quality control were brought together on this project. Our objective was to produce the most accurate, productive hobs on the market today and to back them with timely and experienced product service. We feel that we have accomplished this and that hob users will agree.

There is a "continuity" of leadership at Star Cutter that has made it possible to assemble

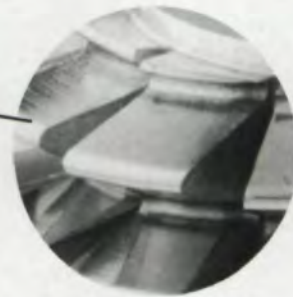
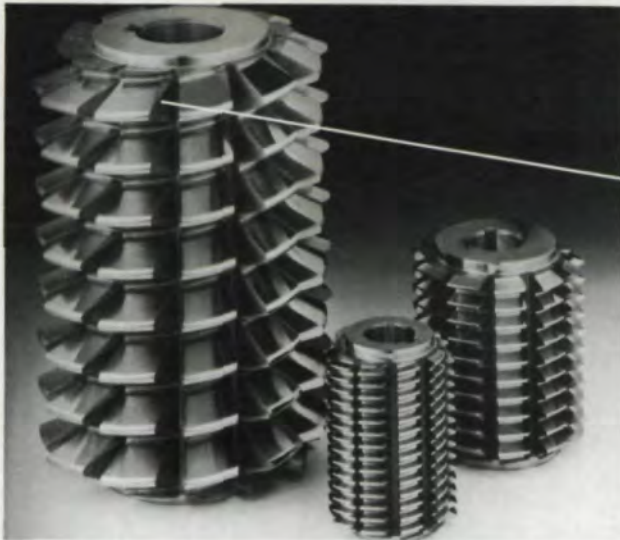

Skived hobs and closeup of skived tooth.

the talent and develop the plant facilities that we have today. Since its founding in 1927, Star has been headed by a member of the Lawton family. Norm Lawton took over active management of the company from his father in 1942 and is president today. He is ably assisted by his son, Brad Lawton, the firm's executive vice president. One grandson, Jeff, has headed the corporate quality control program and is now managing one of the production plants.

There is an "extended family" feeling at Star Cutter that is the result of wise leadership, manageable unit size, and a policy of promotion from within. All plants are managed by people whose careers began in a shop position at one of the Star facilities. These are people who became "hands-on" familiar with a particular product or service, often went

outside for further education, and returned to assume management roles. Visitors often comment on the high morale of our employees and the industrious atmosphere in our plants. These are things that result from this family feeling.

With our extensive specialized resources, our highly motivated employees, our dedication to quality and service, our awareness of and willingness to change with changing technologies, Star Cutter Company looks forward to further growth in serving the metalworking industry. In the words of our president, "We'll find a way or make a way."

For further information regarding our new line of hobs, contact our sales and service subsidiary: StarCut Sales, Inc., P.O. Box 376, Farmington, MI 48332-0376; phone 313/474-8200; FAX 313/474-9518.

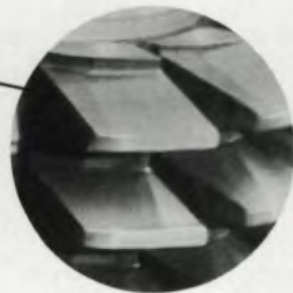

Ground hobs and closeup of ground teeth.

CIRCLE A-19 on READER REPLY CARD

Introducing

TPH

TOCCO Profile Hardening



At last... there's a gear hardening process that provides extra hardness/strength at the pitchline, and optimum strength gradient at the root fillet – without excessive heating and brittleness at the tooth tip. TOCCO Profile Hardening (TPH), a new, highly automated and field proven process developed by TOCCO, merges 3 distinctive technologies: Programmed Preheat (AF – low frequency), High Intensity (RF – high frequency) and Incremental Hardening. All can be comprised in a single, compact, totally integrated manufacturing cell.*

Another TOCCO advantage: The proprietary TPH process usually uses less than 200 KW rated power supplies (AF & RF). So, you don't need an expensive substation, as required by older design contour hardening systems.

TPH provides gearmakers with:

- Increased strength
- Reduced distortion
- Improved metallurgy
- Higher quality
- Lower installation costs
- Reduced operating costs per part

Contact your TOCCO representative for detailed information on TPH... the most advanced, selective or surface gear hardening/tempering system available... anywhere.

TOCCO, Inc., Sales, Service and Technology Center,
30100 Stephenson Highway, Madison Hts. MI 48071.
Phone 1-800-468-4932. In Michigan 313-399-8601.
FAX 313-399-8603

* Photographed at TOCCO-Boaz during run-off

TOCCO®

A Subsidiary of Park-Ohio Industries, Inc.

CIRCLE A-20 on READER REPLY CARD

Induction Profile Hardening Enhances Gear Performance

TOCCO, Inc. has developed a multi-frequency/multi-cycle "Profile" induction heating process which allows gear manufacturers to achieve superior strength and hardness at the root fillet and pitch line of a gear tooth without generating excessive hardening and brittleness at the tooth tip.

The TOCCO Profile Hardening (TPH) process is field proven. Commercial installations include a fully-automated line at the Ypsilanti, MI, Powertrain division of General Motors. This system profile hardens internal gear forward clutch housings and sun gear overrun clutch housings.

Unlike conventional dual frequency induction processes which attempt to generate a uniform energy contour across the tooth tip and profile area, the TPH process produces a nonuniform energy input profile to compensate for nonuniformity in the mass relationship between the tooth tip and tooth root area. In addition to utilizing two or more frequencies, the TPH process also is programmed on a time dependent sequence. This allows extra energy/temperature to be generated in the root area while limiting energy input to the tooth form.

The TPH process can selectively harden gears manufactured from plain carbon and alloy steel, as well as cast iron and powder metal. Several versions of the TPH process are available. The original process is for hardening external diameter gear surfaces and internal ring, spur and helical gears.

Variations of this system which employ static or incremental heating, single or multiple inductors and smaller RF power supplies will process large and small OD and ID gears, as well as multiple function gear components.

Multi-frequency/multi-cycle profile hardening has proven to be a cost effective improvement to conventional dual frequency induction hardening and gas furnace carburizing. The primary benefit offered by TOCCO'S patented process is superior gear performance. Root fillet crack propagation (tooth breakage), pitch line surface degradation (pitting) and pitch line subsurface failures (spalling) are minimized or eliminated.

With respect to carburizing, the TPH process significantly reduces in-process inventory, minimizes or eliminates post heat treat machining and lowers installation and operating costs.

The TPH process can be operated independently or integrated into an in-line production system or manufacturing workcell. TOCCO also has developed microprocessor-based control, monitoring and diagnostic capabilities to support the TPH process.

For more information on the TOCCO TPH profile hardening process, contact George D. Pfaffmann, Vice President of Technology and Service Operations, TOCCO, Inc., a subsidiary of Park-Ohio Industries, Inc., 30100 Stephenson Hwy., Madison Heights, MI 48071. Or call our toll free number: 1-800-468-4932.

SPC Acceptance of Hobbing & Shaping Machines

Brian W. Cluff
American Pfauter Limited Partnership
Loves Park, IL

Today, as part of filling a typical gear hobbing or shaping machine order, engineers are required to perform an SPC acceptance test. This SPC test, while it is contractually necessary for machine acceptance, is not a machine acceptance test. It is a process capability test. It is an acceptance of the machine, cutting tool, workholding fixture, and workpiece as integrated on the cutting machine, using a gear measuring machine, with its work arbor and evaluation software, to measure the acceptance elements of the workpiece.

Depending on the workpiece tolerances and desired capability (Cpk level), this acceptance test can be a relatively simple runoff, or it can be a long, complicated procedure to determine the source of variables in the system.

Rarely is the hobbing or shaping machine a sensitive element in the acceptance process. Fig. 1 shows the relative weighting of the criti-

cal elements of the system in a gear hobbing or gear shaping machine.

Usually, in the proposal stage for a machine order where SPC requirements are defined, American Pfauter engineers reverse-engineer all critical elements of the system to establish if the desired Cpk can be achieved. Often, at first glance, workpiece production tolerances shown on the workpiece drawing are practically achievable. But when the capability indexes are greater than 1.0, the reduction of the allowable values often reveals tolerances which are not readily achievable. In some cases the centering of the average value for a plus/minus 3σ requirement exceeds the achievable accuracies of the generating process. This is typically seen when attempting to conduct an SPC qualification for workpieces which will be subsequently finished by another process, where productivity feeds and speeds alter tooth topography to a

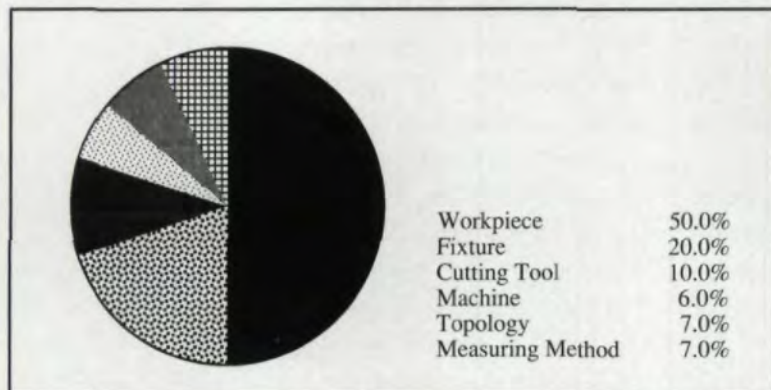

Fig. 1 - Relative weighting of the critical elements of the system in a typical gear hobbing or shaping 6 Sigma machine acceptance for size, lead, and runout criteria. Involute and spacing (pitch) are usually excluded as criteria for pre-shave and pre-roll gear operations, but included as criteria for finished hobbed and shaped operations. The element labelled "Topology" refers to the flank topology of a gear tooth as produced by the feed of the cutting tool and, in the case of hobbing, to the number of threads in the hob.



Fig. 2 - Gear tooth flanks produced by high feed rate, multi-thread hobbing.

level which belabors interpretation in the analytical inspection process. Fig. 2 shows the flanks of gear teeth hobbled for subsequent shaving using high feed rates and a multiple thread hob.

Fig. 3 shows the flanks of teeth shaped by the CCP method for subsequent shaving.

In general, CNC gear hobbing and gear shaping machines manufactured today already must pass a series of static and dynamic alignment and kinematic tests to be considered ready-to-cut workpieces. Figs. 4a and b illustrate 10 of the 19 acceptance checks for a gear

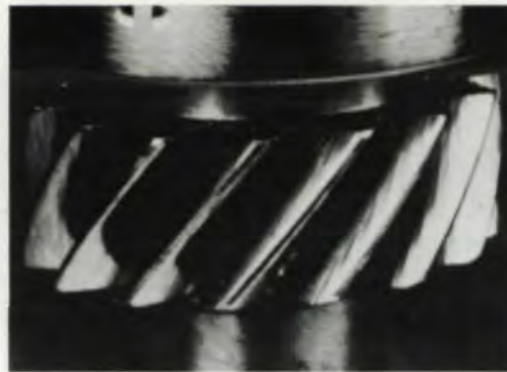

Fig. 3 - Flanks of gear teeth shaped by the CCP high-feed-rate method for subsequent shaving.

Standards of Acceptance for Hobbing Machine P1251 (in accordance with DIN 8642) with Special Accuracy			TR-73		
Serial No:		Consignee:			
Check	Illustration	Measuring tools	Permissible deviation	Measured deviation	Procedure
1 Flatness of table top		Gage blocks Straight edge	+0,035 mm	+0,035	Place straightedge B on two gage blocks A of identical length on table top. Measure distance from table top to straightedge by inserting gage blocks. The table top must not be crowned (convex).
2 Parallelism between table top and column guideway		Gage blocks Straight edge Comparator	-0,020 mm per 1000 mm	-0,02	Place straightedge B on two gage blocks A of identical length on table top. Position comparator on hob head, contact point on straightedge. Displace column over full length of travel and note comparator reading.
3 True running of table top		Comparator	0,020 mm	0,015	Position comparator on table top (at d = 1120mm). Rotate table slowly and note comparator readings.
4 Concentricity of work arbor		Comparator	A 0,005 mm B 0,015 mm	A 0,005 B 0,008	Position comparator on circumference of work arbor. Rotate table slowly and note comparator readings. Take measurement A near cone.
5 Alignment of work arbor and support arm (tailstock) center		Comparator	A 0,015 mm B 0,015 mm	A — B —	Position comparator on circumference of work arbor directly in front of support arm. Rotate work arbor to central position of concentricity error. Note comparator readings with support arm retracted and applied.

Standards of Acceptance for Hobbing Machine P1251 (in accordance with DIN 8642) with Special Accuracy			TR-73		
Serial No:		Consignee:			
Check	Illustration	Measuring tools	Permissible deviation	Measured deviation	Procedure
6 Parallelism between work arbor and hob slide guideway		Comparator	A +0,025 mm B 0,015 mm	A + 0,018 B 0,01	Position comparator on hob head, contact point on circumference of work arbor. Rotate work arbor to central position of concentricity error. Displace hob slide over full length of travel and note comparator readings.
7 Parallelism between work arbor and support arm guideway		Comparator	A +0,020 mm B 0,020 mm	A + 0,015 B 0,02	Position comparator on support arm. Position comparator on circumference of work arbor. Rotate work arbor to central position of concentricity error. Displace support arm slide over full length of travel and note comparator readings.
8 Parallelism between counter bearing recess and tangential slide guideway		Comparator	0,010 mm per 100 mm	0,008 0,01 0,008	Position comparator on bearing recess. Displace tangential slide and note comparator readings.
9 Parallelism between counter bearing recess and tangential slide guideway		Comparator	A 0,010 mm B 0,010 mm	A 0,008 B 0,008	Position comparator on circumference of work arbor. Rotate work arbor to central position of concentricity error. Displace tangential slide over full length of travel and note comparator readings.
10 Concentricity of hob arbors		Comparator	A 0,005 mm B 0,008 mm	A 2° / 0,004 2° / 0,003 B 2° / 0,008 2° / 0,008	Position comparator on circumference of work arbor. Rotate hob spindle slowly. Take measurement A near cone.

Fig. 4a - Standards of acceptance for a hobbing machine (DIN 8642). Tests 1-5. Fig. 4b - Standards of acceptance for a hobbing machine (DIN 8642). Tests 6-10.

hobbing machine according to DIN 8642 standards.

SPC engineers, however, attempt to accept a hobbing or shaping machine through the statistical evaluation a process by checking the product it produces without identifying the inherent variables. Often these attempts become excruciating trials due to:

- a) arbitrary product or process specifications,
- b) arbitrary component specifications,

c) out-of-control process, materials, and equipment,

d) inadequate evaluation and inspection system,

e) little understanding of gear manufacturing processes.

A typical example is the gear manufacturer who expects an SPC acceptance test to a Cpk of 1.67 on a gear designed to AGMA Class 9 tolerances, yet supplies workpiece

Brian W. Cluff

is Vice-President, Sales, at American Pfauter, Ltd. He is the author of numerous books and papers on gearing subjects and is a member of AGMA, ASME, and SME.

TABLE 1						
EFFECT OF SPC ON AGMA QUALITY 9 TOLERANCES (ANSI/AGMA 2000-A88)						
GEAR DATA:	18 TEETH		16.933 NDP			
	25.8419° HA		9483° FW			
	1.1811° PD		STD GEOMETRY, NO MODIFICATIONS			
			VwT	VoT	VrT	VpA
AGMA TOLERANCE (tenths)			0.0004	0.00046	0.0011	0.00082
	SAMPLE SIZE	% TOL.				
CPK 1.33	25	49.1	0.0002	0.00023	0.00054	0.0004
EQUIV. AGMA Q#			13	12	12	12
CPK 1.67	25	39.3	0.00016	0.00018	0.00043	0.00032
EQUIV. AGMA Q#			14	12	12	12
CPK 2.0	25	32.8	0.00013	0.00015	0.00036	0.00027
EQUIV. AGMA Q#			14	13	13	13

NOTE: All statistics based on unbiased estimate of $SD(X)=R/d2$

TABLE 2						
EFFECT OF REDUCED SAMPLE SIZE (PART-TO-PART) ON AGMA QUALITY 9 TOLERANCES ON GEAR DATA IN TABLE 1						
GEAR DATA:	18 TEETH		16.933 NDP			
	25.8419° HA		9483° FW			
	1.1811° PD		STD GEOMETRY, NO MODIFICATIONS			
			VwT	VoT	VrT	VpA
AGMA TOLERANCE (tenths)			0.0004	0.00046	0.0011	0.00082
	SAMPLE SIZE	% TOL.				
CPK 1.33	2	14.1	0.00006	0.00006	0.00015	0.00012
EQUIV. AGMA Q#			>15	15	15	15
CPK 1.67	2	11.3	0.00005	0.00005	0.00012	0.00009
EQUIV. AGMA Q#			>15	>15	>15	>15
CPK 2.0	2	9.4	0.00004	0.00004	0.0001	0.00008
EQUIV. AGMA Q#			>15	>15	>15	>15

NOTE: All statistics based on unbiased estimate of $SD(X)=R/d2$

TABLE 3						
EFFECT OF SPC ON AGMA QUALITY 9 TOLERANCES (ANSI/AGMA 2000-A88)						
GEAR DATA:	96 TEETH		5.08 NDP			
	16.2602° HA		1.9685° FW			
	19.68° PD		STD GEOMETRY, NO MODIFICATIONS			
			VwT	VoT	VrT	VpA
AGMA TOLERANCE (tenths)			0.00065	0.0012	0.00383	0.00177
	SAMPLE SIZE	% TOL.				
CPK 1.33	25	49.1	0.00035	0.00059	0.00188	0.00087
EQUIV. AGMA Q#			12	12	12	12
CPK 1.67	25	39.3	0.00026	0.00047	0.00151	0.00069
EQUIV. AGMA Q#			14	12	12	12
CPK 2.0	25	32.8	0.00021	0.00039	0.00126	0.00058
EQUIV. AGMA Q#			14	13	13	13

NOTE: All statistics based on unbiased estimate of $SD(X)=R/d2$

Tables 1, 2, 3 - The effect of SPC on AGMA Quality 9 tolerances. (ANSI/AGMA 2000-A88)

Legend: VwT = Tooth alignment (lead)
 VoT = Profile
 VrT = Radial runout
 VpA = Pitch

blanks at production tolerances, which may not comply to print specifications (Cpk 1.0) on characteristics, such as bore-to-face perpendicularity and bore size, and which have no tolerance or definition for bore cylindricity, bore roundness, or bore taper. Further, he demands maximum productivity and insists on multi-thread hobs work-

ing at high feed rates. (See Tables 1, 2, and 3.)

The inherent system variables in the gear manufacturing process (see Table 4) can make it difficult to achieve the desired capability for lead and involute, depending on the specification width.

For workpiece/workholding repeatability, these inherent variables can be implied from the following statements:

1) The actual machine workholding axis of rotation must be identical to the actual axis of workpiece rotation.

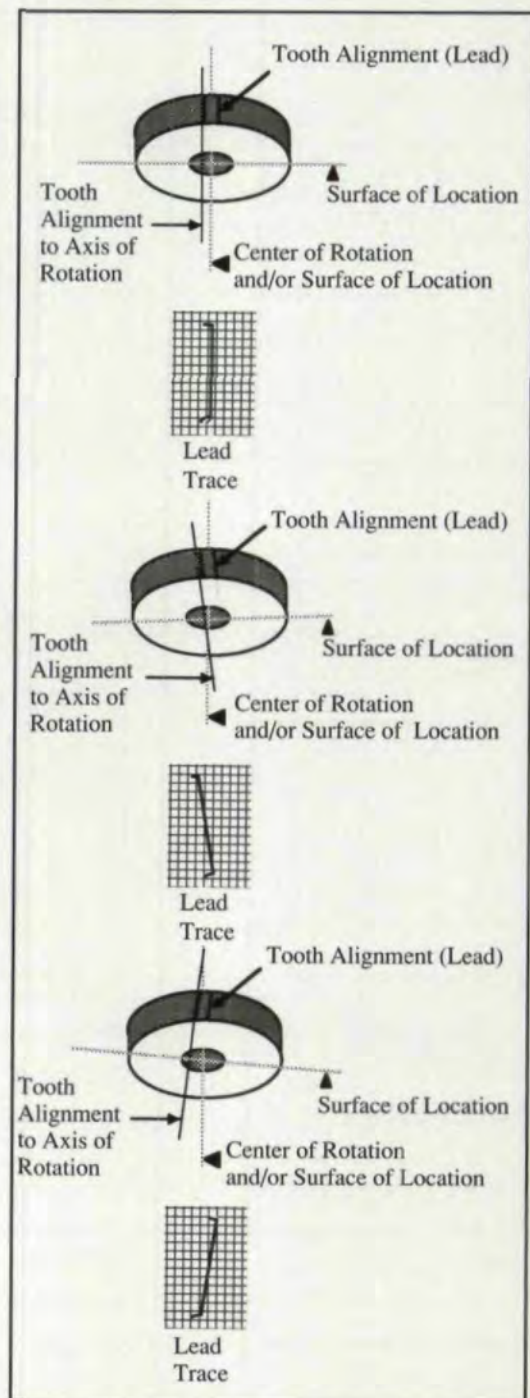

Fig. 5 - The effect of axial face runout on lead variation on a clamped workpiece.

2) Workpieces whose critical locating elements have not been identified and qualified to a compatible capability level will cause the statistical evaluation to fail. Bore geometry variation impacts lead, involute, and radial runout error.

3) Little bore geometry error means less lead, involute, and radial runout variation.

4) Little axial face runout error means less lead, involute, and radial runout error. Fig. 5 illustrates the effect of face wobble in determining lead variation.

5) Greater bore geometry error means less contact between the machine workholding fixture and the actual bore of the gear.

6) Less contact between machine workholding and the actual bore of gear means greater lead, involute, and radial runout variation.

7) Less random variation of number and magnitude of bore geometry errors from part to part and throughout a given sample of parts means lead, involute, and radial runout variation shall be in "statistical control."

8) A greater random variation of number and magnitude of bore geometry errors from part to part and throughout a given sample of parts, means lead, involute, and radial runout variation shall be less "statistically capable."

For inspection workpiece/workholding repeatability these inherent variables can be implied from the following statements:

1) At best, inspection workholding "approximates" the machine workholding axis of rotation.

2) There is always a difference between machine workholding and inspection workholding, which means that the axis of workpiece rotation and the axis of inspection rotation cannot be identical.

3) Greater random variation of number and magnitude of bore geometry errors from part to part and throughout a given sample of parts means greater difference between machine workholding and inspection workholding, which means lead, involute, and radial runout variation will be less "statistically capable."

4) Inspection machine software, designed to draw the average trace of leads on four teeth 90° apart and using the sum-of-least-squares method, can show random lead

Table 4 - Sources of gear element errors.

GEAR ELEMENT	POSSIBLE SOURCE
Tooth Alignment (VwT) (lead)	Machine static alignments Machine thermal stability Electronic synchronization values Tool wear (built-up edges) Measuring machine alignments Measuring machine evaluation software routines
Tooth Alignment (VwT)-variations within a single workpiece	Work fixture arbor radial runout Axial face runout of workpiece "Arborology" (How the arbor fills the bore) Measuring machine arbor radial runout Transfer error between clamping on cutting arbor and measuring arbor Guide looseness (shaper) Feed rates, hobbing/shaping conditions Number threads in hob Tooth topography. (Fig. 7)
Profile (VoT)	Hob number of threads Hob shift variation effect Hob rack form Hob lead (in one turn of helix) Hob mounting on hob arbor Face runout of workpiece Electronic synchronization resolution Work fixture arbor radial and axial runout Feed rates Tooth topography. (Fig. 7) Hob built-up edges
Radial runout (VrT)	Work fixture arbor radial runout Workpiece bore size to arbor differential (solid arbor) Workpiece bore cylindricity "Arborology" (How the arbor fills the bore) Measuring machine arbor radial runout Transfer error between clampings on cutting arbor and measuring arbor

Pitch (VpA)	Machine worktable drive Electronic drive resolution Feed rates Number of threads in hob Flank topography "as seen" by measuring machine probe
-------------	---

Size	Machine X-axis setting Thermal machine growth Hob flute resharpening accuracy Hob thread-to-thread error Feed rates - hobbing /shaping conditions Measuring technique
------	--

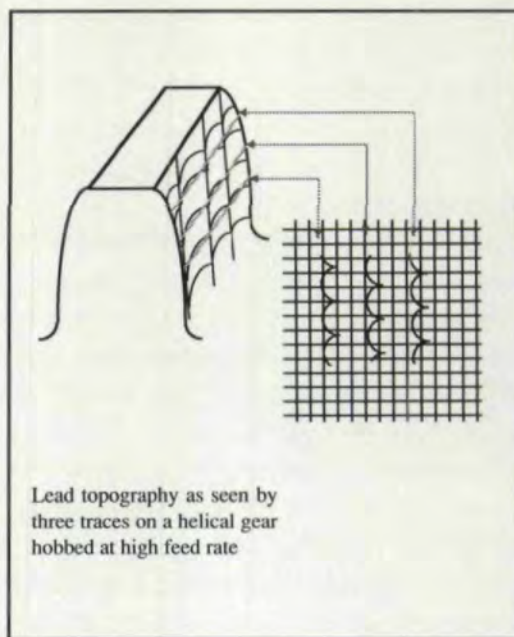

variation on flanks hobbled with multi-thread hobs when the workpiece blanks show little bore geometry and axial face runout error. (See Fig. 6.)

Most manufacturers purchasing machines dedicated to a specific workpiece are naturally interested in qualifying the system to a specific specification. Once that specification is achieved, changing it to a higher requirement at a later date may make the process no longer capable.

For manufacturers purchasing machines to produce several parts to various specification levels, the machine system capability demonstrated on the acceptance workpiece may not be attainable on another workpiece at another specification level.

Fig. 7 - Tooth topography showing three lead possibilities a measuring probe might "see." With reference to Fig. 6 and the introduction of hob thread-to-thread errors to the lead trace, which the measuring probe "sees," further opportunity is provided for incorrect evaluation of the lead.

Manufacturers who purchase brand new equipment for hobbing or shaping gears cannot expect significant improvement in the quality capability of the new process over the old process if they do not improve the prior operations and part geometry specifications involved in the blanking of the workpieces for the hobber or shaper.

Manufacturers who purchase brand new hobbing machines and shaping machines with a specification level of 2.0, tight production tolerances, and low piece number qualification samples should not expect the new machinery necessarily to give them a productivity improvement. Capability indexes greater than 1.0 against stringent tolerance fields on all gear elements severely constrain the gear manufacturing process in the name of statistical control when, in reality, the application of SPC to analytical inspection methods may have no functional validity. In such cases, for hobbing and shaping, an application of common sense is usually necessary. ■

Acknowledgement: Presented at the AGMA Gear Manufacturing Symposium, April 7-9, 1991, Chicago, IL and at an SME Gear Clinic. Reprinted with permission.

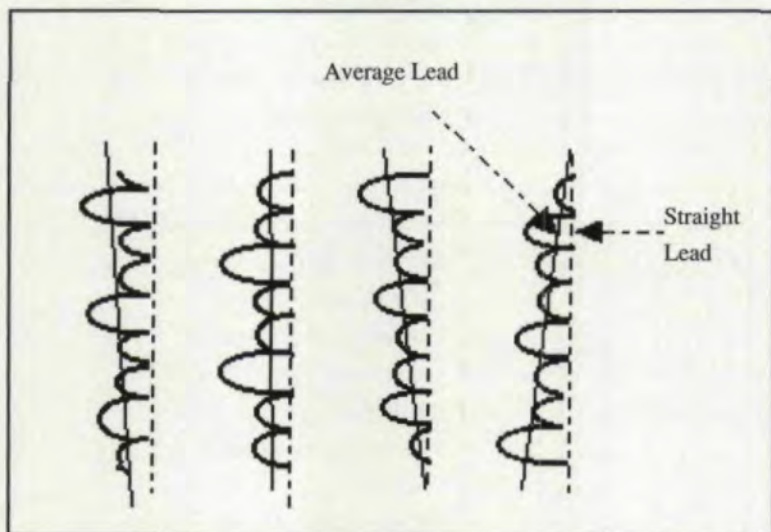

Fig. 6 - Effect of multi-thread hob, thread-to-thread error on average lead value as measured on four teeth 90° apart. Spiral progression of feed rate and thread error alters average lead, even though the lead is straight.

Exciting news for the
gear industry...



... double flank grinding productivity with a new

BHS-HÖFLER gear grinding machines are widely acknowledged as the most accurate gear grinders in the world.



the fastest grinding machines on the market. And the best: BHS-HÖFLER machines are still the most versatile ones. You can grind any gear with almost no tool cost, using standard inexpensive grinding wheels, automatically dressed to size on the grinder and of course with our CNC-dresser.



inexpensive wheels unlike form grinding wheels. Profile or lead modifications are no problem. Every BHS-HÖFLER is capable of grinding even the most complicated tooth forms to meet your present and future requirements.



A BHS-HÖFLER machine will grind your gears just when you need them with very



Now - BHS-HÖFLER introduced the improved double flank grinding method* to compete even with

** Double flank grinding means: simultaneous grinding of two opposite tooth flanks with both sides of a rigid-rack type formed grinding wheel in mesh. It is still the most accurate generating method and it is now faster than form grinding.*



PRODUCTIVITY

Have you ever checked your set-up times? You are losing hundreds of hours of valuable production time with the grinding machine idle while you are setting up the gear and fixture on the machine.

Now our newly developed **precision pallet loading system** offers unbeatable produc-

g: 30-50 % more v gear grinding system.



tivity! Our pallet setup stations will keep your grinders busy. Much faster change-over time. All unproductive setup time is done outside the machine where it belongs while your grinders grind gears hour after hour – uninterrupted. Twenty four hours a day? No problem, pallets can be lined up for the 2nd or 3rd shift operation.

SUPPORT

To get the maximum productivity from your BHS-HÖFLER, we now offer a training program for your operators. Experienced instructors let you benefit from their life-long obtained know-how. Our computer program is available to calculate grinding times, machine set-up data and other valuable parameters.

Even the best machines need service and parts from time to time. Our factory-trained service engineers are available from BHS-HÖFLER CORP., New Jersey.

In addition to spare parts we stock grinding wheels and other perishables in our U.S. facility.

For more information, call or write to
BHS-HÖFLER CORP.
P.O.Box 127
Sky Manor Road
Pittstown,
NJ 08867
Tel.: 908-996-6922
Fax: 908-996-6977



We will be more than happy to arrange a demonstration in your area at one of our U.S. customers or to organize your trip and visit to BHS-HÖFLER in Ettlingen, Germany.



You are producing hardened and ground gears. A product with a bright future because more and more gears are ground. But like in every competition only the best will survive. The gear grinding operation in your company is probably the most important one because this is where your name goes on your product. BHS-HÖFLER state of the art gear grinding machines send signals to your customers that your company is a leader in its field because you are capable of producing the highest quality products. Get the best, contact us and we will put you in the company of the most successful gear manufacturers in the world. Let's do it together.

BHS-HÖFLER sales agents in the USA:

Western States:

AMERICAN MACHINERY
AND ENGINEERING CORPORATION
P.O.B. 2157
Mission Viejo, CA 92690
Tel.: 714-586-2000
Ask for Ron Luebke

Indiana, Illinois, Wisconsin, Iowa, Minnesota:

JRM & ASSOC., INC.
5633 East State Street
Rockford, IL 61108
Tel.: 815-397-7557
Ask for Jim Mattox or Mark Biteler

New England States:

LYND-FARQUHAR CO.
East Point Crossing
176 East Main Street
Westborough, Mass. 01581-1706
Tel.: 508-898-9494
Ask for Howard Rich or Rob Smith

E-Pennsylvania, New Jersey, Maryland, Carolina:

HOLCO INC.
8 Lindenwold Terrace
Ambler, PA 19002
Tel.: 215-283-0156
Ask for Emil or Marc Conti

W-Pennsylvania, Michigan, Ohio, Kentucky, Virginia:

J. LEE HACKETT COMPANY
23550 Haggerty Road
Farmington, Michigan 48335-2636
Tel.: 313-478-0200
Ask for J. Lee Juett or John McCartney



BHS-Höfler Maschinenbau GmbH
Industriestraße 19 · D-7505 Ettlingen 7 · Germany
Tel. 072 43 / 99 10 · Telex 782 907
Telefax 072 43 / 99 165



Full-Load Testing of Large Gearboxes Using Closed-Loop Power Circulation

R.B. Frost

University of New South Wales, Kensington, Australia

T.R. Cross

John Welsh Pty. Ltd, Melbourne, Australia

Summary: This method of testing large gearboxes or, indeed, any power transmission element, has numerous advantages and offers the possibility of large savings in time, energy, and plant, if the overall situation is conducive to its use. This usually requires that several such units need to be tested, and that they can be conveniently connected to each other in such a way as to form a closed-loop drive train. No power sink is required, and the drive input system has only to make up power losses. The level of circulating power is controlled by the torque, which is applied statically during rotation, and the drive speed. Principles, advantage, and limitations are described, together with recent experiences in the only known large-scale usage of this technique in Australia.

Introduction

Full-load testing of large gearboxes and other power transmission modules or components has traditionally been carried out with the testing drive train arranged in a schematically linear or open manner, as shown in Fig. 1a. This necessitates the use of a power source and a power sink, or brake, each with a capacity at least equal to that of the required test. Further, all energy which passes through the gearbox under test, which can be considerable, is wasted in the sink. This last factor is compounded if numerous units need to be tested. If the rated power of the gearbox under test is large, and the output speed is low, the torque at the sink can be inconve-

niently massive, unless further supplementary gearing is provided. One way of doing this, of course, is to test two gearboxes simultaneously in series, as shown in Fig. 1b. This, however, does nothing to avoid the necessity for a large source and sink.

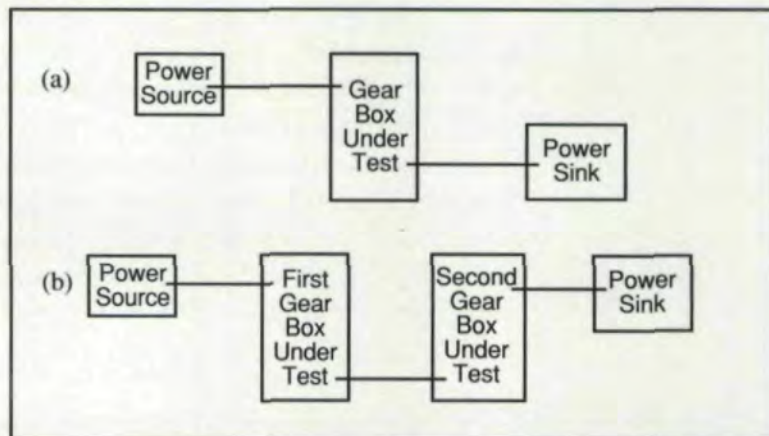

Fig. 1 - The traditional, schematically open arrangement of gearbox test rigs: (a) the simplest arrangement; (b) a tandem arrangement which tests two gearboxes simultaneously and which avoids a massive torque at a low speed at the power sink.

The above situation can be markedly improved by the use of a closed-loop arrangement of the test drive train. Such an arrangement allows the return to the test system of the output power from each gearbox under test, so that

- no power sink is required;
- the power source only has to provide make-up power equal to the sum of system losses;
- several gearboxes are tested simultaneously.

Obviously, large savings can accrue from the avoidance of the necessity for a power sink and

R.B. Frost

is Senior Lecturer,
School of Mechanical
& Industrial Engineering,
University of New
South Wales.

T.R. Cross

is Managing Director,
John Welsh Pty. Ltd. in
Melbourne, Australia.

from the large reduction in the required capacity of the power source. If numerous units need to be tested, large savings in time and energy are possible.

Disadvantages or limitations on the use of such a test method are that

- non-backdriving gearboxes, such as high-ratio worm drives, cannot be tested in this manner;
- a somewhat larger floor area is required for the test setup;
- the power level in each gearbox in a particular setup will be slightly different due to losses around the drive train loop;
- the method is best suited to situations where at least as many gearboxes need to be tested as are required to make up the drive train loop;
- if the number of units to be tested is not an integral multiple of the number required to make up the loop, some will need to undergo two tests to allow formation of the final loop at the end of the series of tests.

While such multiple simultaneous testing is not uncommon in Europe, it has not been used to any great extent in Australia.

The Drive Train Loop

This consists of several of the units to be tested, coupling shafts, and three other components: a motion input drive, a torque application coupling, and a torque transducer.

Such a loop can be achieved in several convenient ways. If the gearboxes are parallel-shafted, two can be coupled as shown in Fig. 2; if they involve shafts at right angles, e.g., as with bevel

input stages, then four can be coupled as shown in Fig. 3. For generality, and because of recent experience with such a setup, the remainder of this article is written as relating to a setup as shown in Fig. 3.

The three additional components referred to above can be incorporated in any convenient manner or location in the loop. The drive input can be incorporated in a coupling shaft as a belt or chain drive or as a separate gearbox with a double-ended output shaft, or it can be attached directly to a shaft extension on one of the units under test, if one is available. Alternatively, if the motor speed corresponds to the speed of the high-speed shafts, and the motor has a double-ended shaft, it can be incorporated directly in one of the high-speed shaft lines. The torque application coupling is a device which joins a pair of adjacent shaft ends and which applies equal and opposite torques to them while they are both rotating, and in the presence of some degree of relative rotation between them. It may be thought of in practice as a hydraulic motor, supplied and drained by two lines via a rotatable hydraulic coupling, with its shaft connected to one of the two shaft ends referred to above, and its body connected to the other.

The Action of the Test Rig

This is best described by considering the rig at rest while the torque application coupling is loaded by the application of hydraulic pressure. The whole drive train loop is thereby loaded torsionally so that each section of it, being in torsional equilibrium, has equal and opposite torques at its two ends; i.e., an action and a reaction. If the motion input is now started, the whole drive train loop will rotate in the direction in which it is driven. For a particular loop section, the applied torque and the rotation will be in the same direction at one end, where power will be entering that loop section, and in opposite directions at the other end, where power will be leaving that loop section. This applies to each loop section, so that power circulates continuously around the drive train loop in a direction which is determined by the combination of the directions of the drive rotation and the torque application.

The level of circulating power is determined by the combination of the speed of the drive rotation and the level of the torque application.

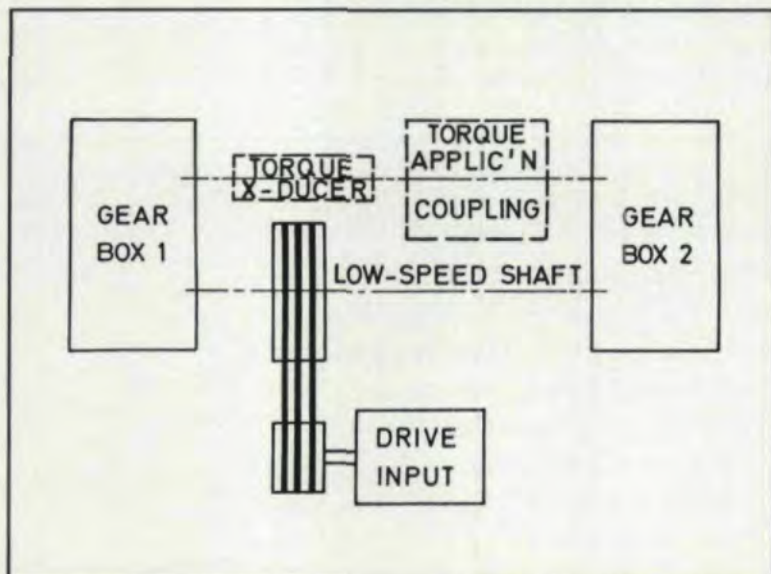

Fig. 2 - A closed-loop arrangement for testing two parallel-shafted gearboxes simultaneously and utilizing circulating power, thereby avoiding the necessity for a power sink.

With the exception of the losses due to the inefficiencies in the gearboxes, power does not leave the drive train loop; therefore, it does not need to be provided by the drive input, except for the losses, regardless of the level of the circulating power.

Power flows and losses are shown in Fig. 3. If P_1 is the input power to the gearbox on the "downstream" side of the drive input (in the power-flow sense) and P_5 is the power delivered to the drive input by the adjacent gearbox on the "upstream" side, then

$$P_5 = \eta^4 P_1 \quad (1)$$

where η is the efficiency of each individual gearbox, so that the total power loss is given by

$$P_{\text{loss}} = P_1 - P_5 = P_1(1 - \eta^4) = P_{\text{input}} \quad (2)$$

The input power fraction, which is the ratio of input power required when using a closed-loop rig to that required when using a rig of the type shown in Fig. 1, where input power must equal test power, is given by

$$f_p = \frac{P_{\text{input}}}{P_4} = \frac{1 - \eta^4}{\eta^3} \quad (3)$$

where P_4 , which is the lowest input power level to any gearbox in the loop, is taken to be the agreed power level for the test. This agreement could be made differently, of course, in which case, f_p will be defined differently, but this will make little difference to f_p .

The input energy fraction for testing a series of gear boxes in this way, rather than as in Fig. 1, is given by

$$f_E = \frac{f_p}{N} = \frac{1 - \eta^4}{N\eta^3} \quad (4)$$

where N is the number of gearbox units tested simultaneously. In the situation considered here, $N = 4$.

Similarly, the overload factor on Gearbox 1, in order to achieve P_4 into Gearbox 4, is given by

$$F_O = \frac{P_1}{P_4} = \frac{1}{\eta^3} \quad (5)$$

Fig. 4 shows values of f_p , f_E , and F_O for a range of η which is realistic for a large range of gear-

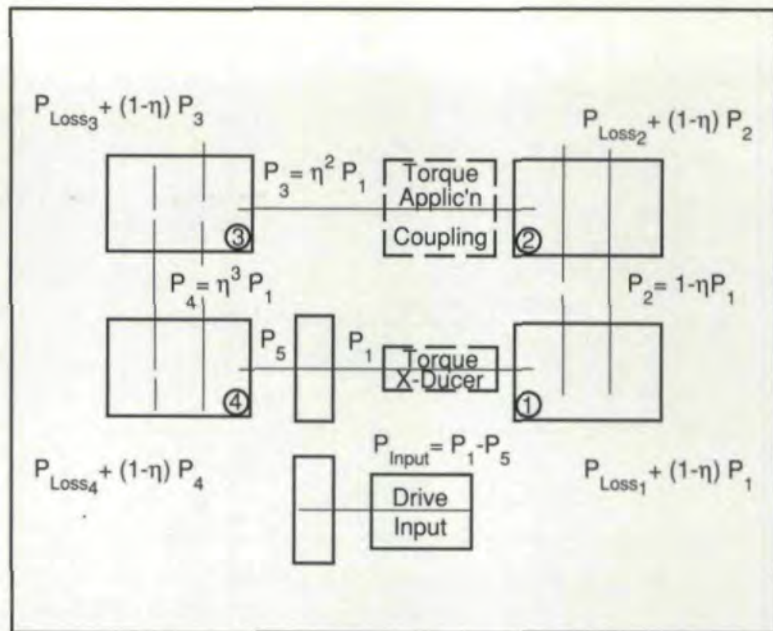

Fig. 3 - Similar to Fig. 2, but to suit four right-angle-drive gearboxes. Power flows and losses are shown.

boxes. Clearly, large savings in installed capacity, time and energy can be realized, provided the overload on some units can be tolerated for the duration of the test. This overload is, of course, significantly reduced if P_1 , P_2 , or P_3 can be agreed upon as the power level for the test, rather than P_4 .

Consideration needs to be given to the "handling" of gearboxes and the resulting compatibility of rotation around the drive train loop. Regardless of this, however, it is necessarily true that one diagonally opposite pair of boxes will be operating in the schematically forward (power-flow) sense as speed reducers, bearing on the forward flanks of the teeth, while the other diagonally opposite pair are operating in the schematically backward sense as speed increasers, bearing on the rear flanks. For spiral bevel gearing the differences in geometry and force levels between these two cases are significant. Whether this is seen as a problem, as in the necessity to prove every box in every mode, or as an opportunity whereby each of these two cases can be demonstrated simultaneously, depends on the way in which test requirements are written. At most, however, this problem would only involve a reversal of rotation and/or torque in the same setup once testing is under way.

Recent Experience With Closed-Loop Testing

John Welsh Pty. Ltd. of Melbourne recently supplied 21 gearboxes, each rated at 610 kW, 1485 RPM input speed, 17.76:1 reduction ratio with a spiral bevel input stage and a helical

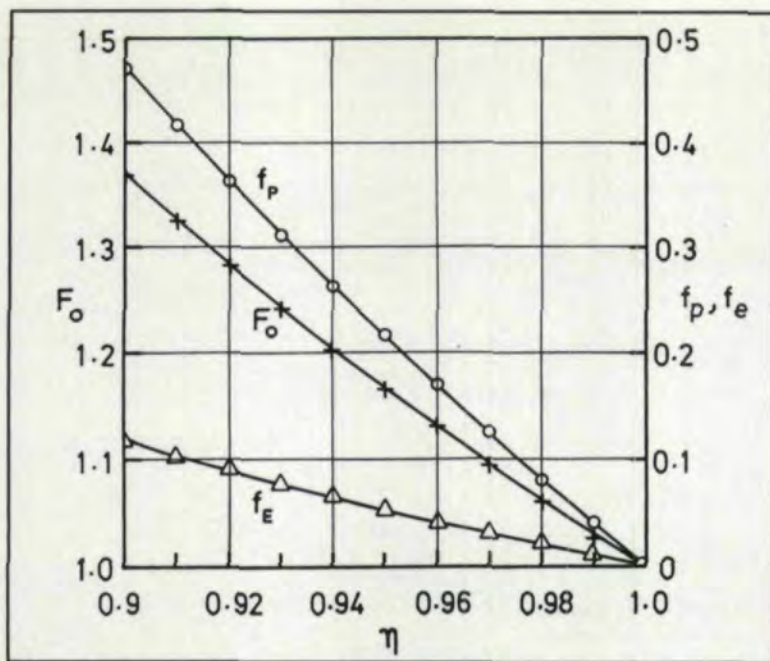

Fig. 4 - Variation of energy fraction f_E , power fraction f_P , and overload factor F_O for a range of efficiency, η , for the setup shown in Fig. 3.

output stage, for coal conveyor drives. These were tested four-at-a-time in an arrangement similar to that shown in Fig. 3, at 50% of full load and then at 100% of full load, in each case until temperature equilibrium was reached and thereafter to allow noise measurements to be taken.

Drive input was via a multiple V-belt drive of the appropriate ratio from an induction motor rated at 220 kW at 960 RPM, onto one of the high-speed shafts connecting the gearboxes. This shaft also contained the torque application coupling, which was a proprietary item, model VM2-4000-100 from Glyco in Germany. It provided two active hydraulic chambers in each direction to facilitate the production of a large torque from a compact design, and thereby provided a total relative rotation of only 100°. The elastic torsional deflection around the drive train loop at 115% of full-load torque, θ_E , was calculated to be approximately 31.5° of relative rotation at the adjacent shaft ends where the torque application coupling was to be located and the backlash in the gearing, θ_{BL} , was estimated to be approximately 5.5° at this location. For loading in both directions, this required a total relative rotation of the torque application coupling of

$$\theta_{TOTAL} = 2\theta_E + \theta_{BL} = 68.5^\circ \quad (6)$$

which was within its range and which left

approximately 31.5° for angular assembly of the flanges of this coupling, which, it was anticipated, would be assembled last in the drive train loop with its mating flanges on the adjacent coupling shaft ends. In the event, however, it was found that the torque transducer had sufficient holes in its flanges to allow convenient final closure and connection of the drive train loop at its flanges, with the torque application coupling initially set so that it had approximately 75% of its stroke available in the required direction of testing.

The Lebow 1641-100K torque transducer was located in the other high-speed shaft.

In each instance of testing, the motor driving the rig was started while the torque application coupling was subject to a small required minimum pressure of approximately 5 bar. This gave rise to the necessity to overcome some degree of initial stiction in the lightly torsionally pre-loaded rig. This was not a real problem, however, and once the rig broke the stiction and started to move, it ran very freely. The hydraulic pressure to the torque application coupling was then progressively increased, thereby increasing the circulating power level, the losses, and the motor load, until the required reading was achieved on the torque meter. This reading, of course, had to be calculated specifically in view of the position in the drive train loop occupied by the torque transducer. The rig was then run as required for the testing procedure. In all cases the rig behaved in a stable manner and the testing proceeded without problems.

Conclusion

Simultaneous testing of multiple gearboxes using a closed-loop test rig arrangement is a very convenient and cost-effective testing method where the conditions favoring such a method, as outlined in the introduction, are satisfied. On such occasions, the authors recommend consideration of this method. ■

Acknowledgement: This article was originally presented at The Institution of Engineers, Australia, Fifth International Conference on Manufacturing Engineering, July 11-13, 1990, Wollongong, NSW, Australia. Reprinted with permission.

THE INDUSTRY'S HIGH TECH WORKHORSES

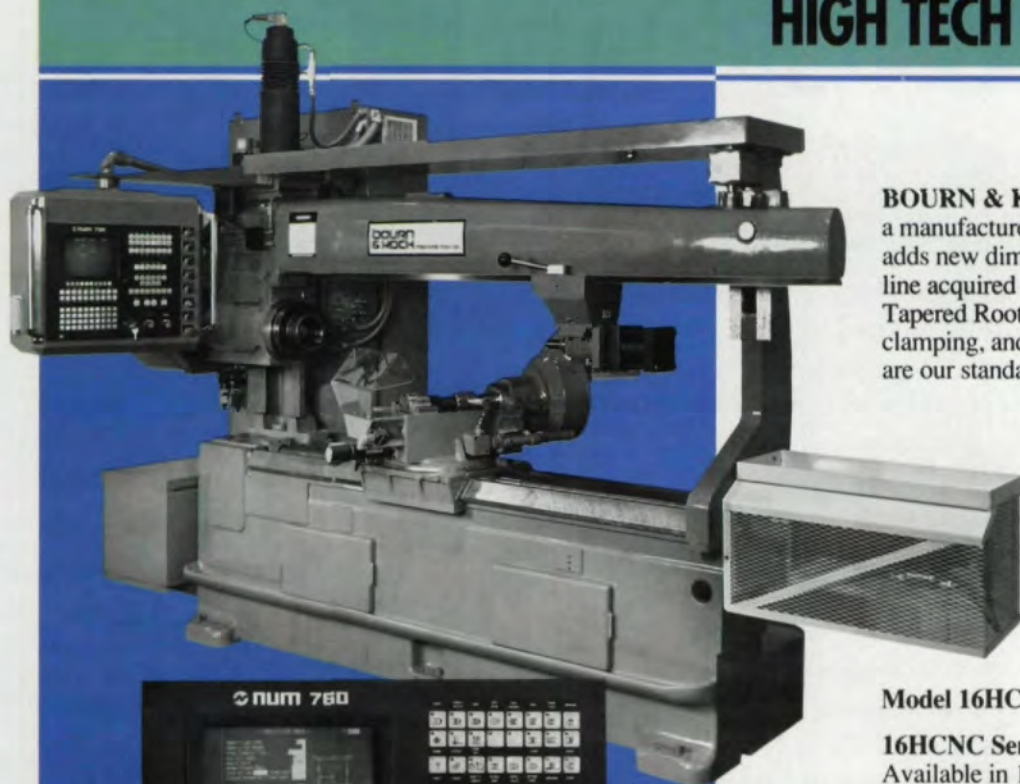

BOURN & KOCH MACHINE TOOL CO., a manufacturer of precision products since 1975 adds new dimensions to the Hobber & Shaper line acquired from Barber- Colman Company. Tapered Root spline hobbing, automatic hob clamping, and water soluble coolant capabilities are our standard options.

Model 16HCNC-56

16HCNC Series

Available in 16, 36 and 56 Models
Max. Work Diameter..... 16"
Max. Work Length..... 16", 36", 56"
Max. Hob Diameter..... 6"
Max. Hob Length..... 7"
Crowning, Doubling Cutting, Radial/
Tangential worm gear cycles.

The machines are controlled by a 32 bit NUM 760E Gear Hobbing CNC Controller which is especially designed for hobbing.



Model 300HCNC

300HCNC Series

Available in 300, 400, and 600 Models
Max. Work Diameter.... 12", 16", 25"
Max. Work Length..... 40", 48", 144"
Max. Hob Diameter..... 6"
Max. Hob Length..... 7"
Also offers Carbide Hobbing capabilities.

**BOURN
& KOCH**
MACHINE TOOL CO.

2500 Kishwaukee Street
Rockford, IL 61104
(815) 965-4013
Fax (815) 965-0019

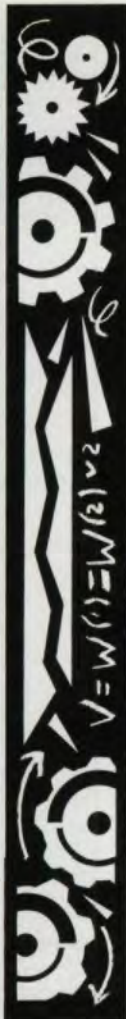

Basic Gear Generation Designing the Teeth

Robert Moderow

ITW, Illinois Tools, Lincolnwood, IL

The finished gear engineer, the man who is prepared for all emergencies, must first of all know the basic design principles.

Next he must be well versed in all sorts of calculations which come under the heading of "involute trigonometry."

He should know the various shop methods of producing and checking gears...know how to interpret the various checks...and know the capabilities and limitations of shop equipment. To all of this he should add a smattering of metallurgical knowledge and, finally, he should have made a study of various applications and the unlimited number of conventional and unorthodox methods of transmitting motion through gears.

At the basis of it all, however, is the job of designing, laying out, proportioning, and dimensioning the gear tooth, and analyzing the line of action picture. In most cases, this is all that is required to create good running gears.

Further improvement in designing gears and transmissions will be the result of experience in many applications.

In his selection of tooth proportions, the designer is guided by a long established standard. Spacing, height, and pressure angles have been fixed. The spacing of gear teeth, or pitch, is seldom designated by actual circular distance at the pitch line, but rather by the value of π , divided by the actual circular distance. The standard has selected values for pitch line spacings which are evenly divisible into π . As a result, there are so-called diametral pitches of 1, 2, 3, 4, etc. Standard value for the addendum is 1 over D.P., and the dedendum, in order to allow for clearance for the mating addendum, is 1.157

over D.P.* for Coarse Pitch † gears and 1.200 over D.P. + .002 for Fine Pitch † gears.

Creation of even diametral pitches of 1, 2, 3, etc., however, results in considerable differences in circular pitch. Between 1 and 2 diametral pitch, the difference is about 1 1/2". Therefore, the coarser pitches are again divided into even quarters: 1, 1 1/4, 1 1/2, etc. On the other hand, there is so little difference between the finer pitches, (for example, 60 and 61 D.P.) that the designer's choice should be either 60 or 64 D.P.

The system of diametral pitch is somewhat confusing, and the explanation that D.P. means the number of teeth per inch of pitch diameter does little to clarify it. In reality it is nothing but a numbering system. Everyone knows, of course, that this numbering system has certain advantages for figuring diameters and center distances.

From the standpoint of design, the D.P. standard is of little help. If a chief draftsman were to tell one of his men that he wanted to use teeth spaced about 1/2" apart and about 3/8" high, the man would immediately have a mental picture. When told, however, that the teeth are to be 6 D.P., he must first translate that figure into actual circular pitch and height before he can visualize the proportions. It is considerable time before the D.P. numbers become firmly associated with proportions.

For some engineers, the existence of standardized diametral pitches has a tendency to absolve them of responsibility for gear tooth design and leaves them with the impression that all they have to do is specify pitch and pressure angles on their drawings. Such incomplete specifications are an indication that the designer does

* While the latest AGMA standard specifies a coarse pitch dedendum of 1.250 over D.P., most gear hobs and gear cutters are currently made to cut 1.157 over D.P. (American Standard B6.1-1932) unless otherwise specified.

† Fine Pitch = 20 D.P. and finer. Coarse Pitch = Coarser than 20 D.P.

not know what is going to happen when the gear he designed runs with its mate. The result is that some gears fail to give satisfactory service.

Proper engineering of gears must be based upon correct knowledge of their action and is essentially the process of actually drawing the gear teeth in magnified scale and placing them into a picture which shows their operating relationship to their mating teeth. The resultant picture is easy to understand and easy to make. It is the same for a 1 D.P. gear as for a 100 D.P. gear, for the involute curve belongs to a family of geometrically proportioned curves. It applies to spur, helical, herringbone, and worm gears. In principle, it applies to all gears. It represents the basis of good gear engineering.

The suggestion of actually designing gear teeth does not intend to imply that our standards are not satisfactory. On the contrary, the system of standard pitches has so many sizes to choose from that one of them is bound to be suitable. Departure from standard pitches is necessary only in those cases where special conditions of size and center distance must be satisfied.

Gears are used to transmit motion and power at constant angular velocity. The specific form of the gear which best produces this constant angular velocity is the involute. The action between the teeth of a pair of gears is called "mating" or "conjugate" action. Of course the involute is not the only tooth form which is capable of conjugate action. Almost any other shape may be made to mate with an opposing profile. Gears, however, are universally made with involutes, and conjugate shapes other than involutes are not usually developed, except in the case of worms and worm gears or in some bevel and pump gear designs.

It is not necessary to go into the characteristics of involutes - numerous text books explain them well. Every involute gear has one and only

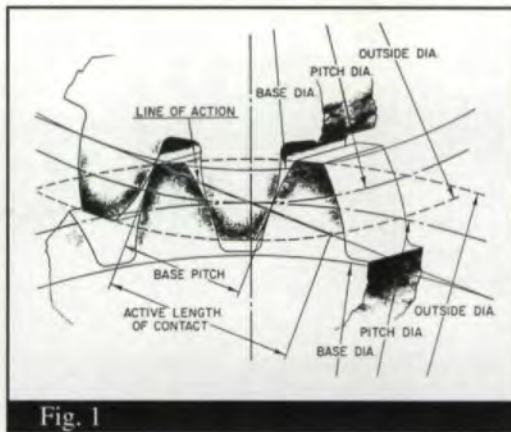

one base circle from which all of the involute surfaces of the gear teeth are generated. This base circle is not a physical part of the gear and cannot be measured directly. The contact between mating involutes takes place along a line which is always tangent to and crossing between the two base circles. This is the line of action. This line of action is a line on paper only. In reality, on spur, helical, worm, and all gears which are not paper thin, it is a plane of action.

Any part of one involute may be used to run with any part of another. The debate as to which part of the involute is most useful has gone on for quite some time. For a long time, pressure angles of about $14\frac{1}{2}^\circ$ to 15° were favored, but for the last 10 to 20 years, 20° pressure angles have proven generally more suitable.

The active length of the line of action is evidently limited by the O.D.'s of the two gears. (See Fig. 1.) With small pinions, it is sometimes further limited by the contact point of the line of action with the base circle or with the undercut. (See Fig. 2.)

The distance between successive gear involutes along a line running tangent to the base circle is called the "base pitch." If the length of the line of action is divided by the base pitch, a figure is obtained which is called the tooth contact ratio. This division should indicate that one tooth is well in action before the preceding tooth lets go. (See Fig. 1.) Theoretically, it must equal at least one. Practically, in order to compensate for inaccuracies in the gears, it should not be less than 1.40. It may be less only in those cases where accurate gears are produced.

Since low numbers of teeth in gears are usually avoided because of undercut and pointed teeth, it is usually not difficult to meet this minimum requirement with standard tooth pro-

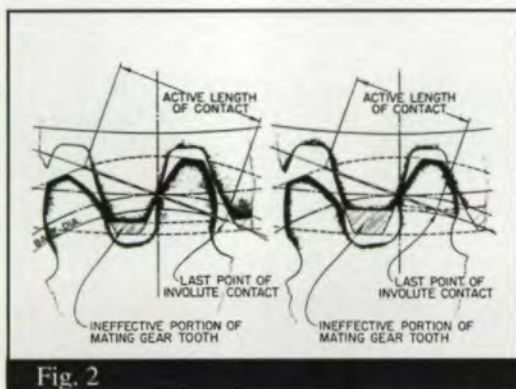

Robert Moderow
is the training manager at ITW, Illinois Tools. He has over 35 years experience in gearing and is the author of numerous books and articles on gearing subjects.

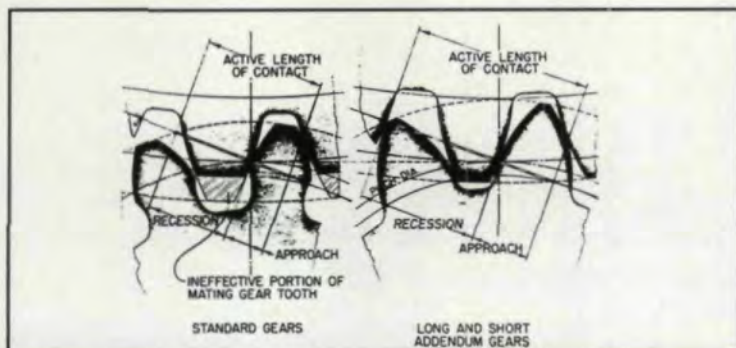

Fig. 3

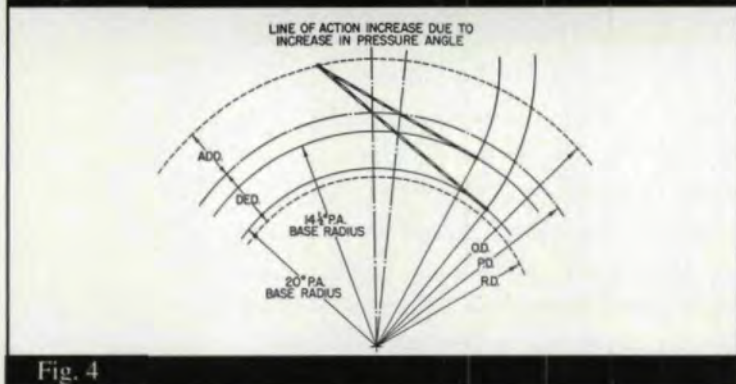

Fig. 4

portions. In those cases, however, where small pinions must be employed, tooth contact ratio is likely to be insufficient because of the high base diameter and undercut.

As a rule, when a pinion has a low number of teeth, the mating gear has a high number. It is usually the demand for a high ratio which forces the designer to select a small number of pinion teeth. When ratios such as 3 to 1 and over occur, there is a very convenient method of lengthening the line of action and at the same time avoiding excessive undercut. This method is called the "long and short addendum system." The addendum of the pinion is increased by the same amount that the addendum of the larger gear is decreased.

The amount of increase is dependent upon the pressure angle and the number of teeth in both the pinion and the gear.

The pinion must not be increased to such an extent that the tip of the tooth becomes pointed or that the structure of the mating gear tooth deteriorates.

Generally speaking the amount of increase to the standard addendum of the pinion will be less than 50%; however, theoretically it may be any amount necessary to achieve a realistic balance between the tooth structures of the pinion and gear. (See Fig. 3.)

Long and short addendum gears still roll

at the same standard pitch diameter. They represent a system in which the action between gear teeth in the arc of recession (assuming the pinion as the driver) is increased at no sacrifice of action in the arc of approach, because the arc of approach is limited by the undercut anyway. The long and short addendum system should only be used in those instances where undercuts and high base circle diameters limit the line of action. There is no point in increasing the addendum of one gear at the expense of the other in cases where there is no undercut. It would only mean a transfer from the arc of approach to the arc of recession with no increase in the active length of the line of action.

Long and short addendum gears are produced with standard hobs simply by sinking-in to standard $D + F$ from the increased O.D. of the pinion and correspondingly decreased O.D. of the big gear. They have the same base circles as standard gears.

In the case of small pinions, the length of the line of action increases with the pressure angle. This is not generally true for larger gears or in those cases where the O.D. of one gear does not sweep beyond the line of action's contact with the base circle of the mating gear. This fact, however, actually represents another argument in favor of the 20° P.A. involute system. (See Fig. 4.)

There is another system of making long and short addendum gears which attains the same effect in a more obscure form. It is a method for cutting 11 teeth into a 12-tooth blank, or 12 teeth into a 13-tooth blank, etc. The results are the same, but the procedure is more complicated.

Long addenda gears must not be confused with oversize gears. Oversize gears are those which run on larger-than-standard center dis-

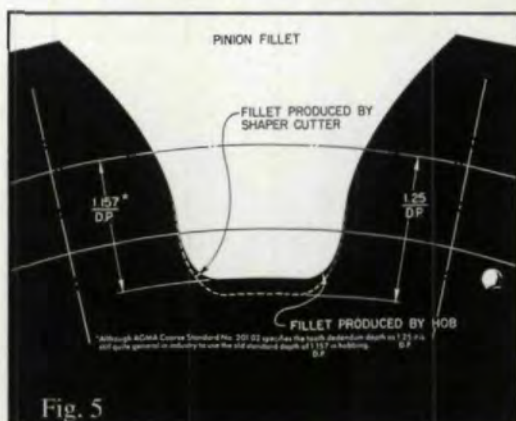

Fig. 5

tances. One of the many advantages of the involute is that it is independent of center distance. The involutes as such roll perfectly. However, when the distance between two gears is increased, they establish new rolling pitch diameters and, at those diameters, become gears of different pitch, pressure angle, and tooth thickness. If the spread is small, they may still be hobbed with standard hobs at the sacrifice of a little backlash, tooth thickness, or depth. If the spread is considerable, new hobs of an odd pitch might be necessary.

In spite of the fact that special tools might be required, some designers insist on maintaining the impression that the gears are over-size or spread-center distance standard gears. There is really no benefit in doing this. The gears might as well become gears of a new pitch with standard 20° pressure angle and addendum and dedendum based on the new pitch. In that way, standard, well-established proportions are maintained.

The length of the line of action, the tooth contact ratio, and the use of standard addendum and depth still do not tell all there is to know about gear teeth. In order to determine what they really look like, their method of production must be taken into consideration. Hobbing produces different shapes than shaping, and such operations as shaving and grinding call for more than the ordinary tooth design. An involute is an involute regardless of how it is produced, but shaping produces different fillets and undercuts than hobbing. Because of this, shaped teeth are always made deeper than hobbed teeth. Their dedendum is 1.25 over D.P. (See Fig 5.)

True tooth shapes are best produced on the drawing board, magnified from ten to fifty times by rolling one sheet of tracing paper over another, showing a drawing of the hob tooth. The outline of the hob tooth is traced through several times until the full form is generated. This is really nothing but an imitation of the actual machine process. In making the drawing of the hob tooth, it must be realized that it is not made with sharp corners, but with a radius of approximately 10% of the tooth thickness. The various enveloping lines are connected with a heavy line representing the involute, fillet, or undercut. Pictures of both gear teeth, produced on separate sheets of tracing paper, are then transferred to the line of action picture. (See Fig. 6.)

The picture at this stage shows the true tooth shapes, the width of the flat at the top of the teeth, the fillet or undercut, the length of the line of action and, through division by the base pitch, the tooth contact ratio. It also shows the last points of contact with the mating gear and indicates whether there is any interference between the fillet and the tip of the mating gear. (See Fig. 7.)

A picture like this serves the purpose for gears which are merely hobbed or shaped. The situation is more complicated when gears are to be shaved or ground. The addenda of shavers are longer than those of the mating gears because they must shave beyond the last point of contact. Therefore, hobs which precede a shaving operation are made with extra depth. In addition, they are usually made with a protuberance which is slightly greater than the amount of stock removed by shaving. This protuberance undercuts the involute profile and sweeps out at a certain point. The tip of the shaving tool meets or overlaps the point of intersection between the involute and undercut. This point of intersection must be at least .015" to .020" below the last point of contact with the mating gear. (See Fig. 8.)

Special problems also arise in the case of round-bottom gear teeth. This system has gained great prominence in recent years. It is used almost exclusively in gears for aircraft engines

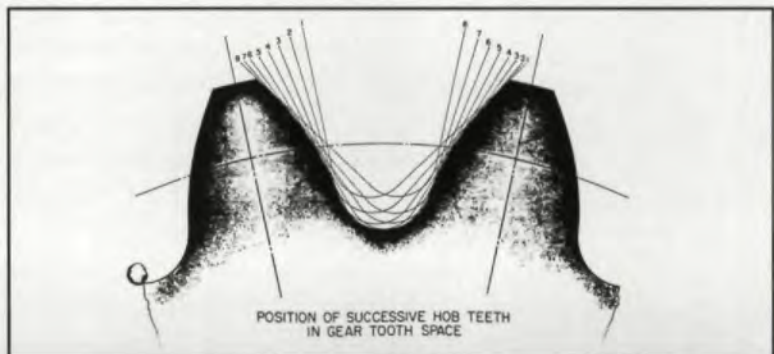

Fig. 6

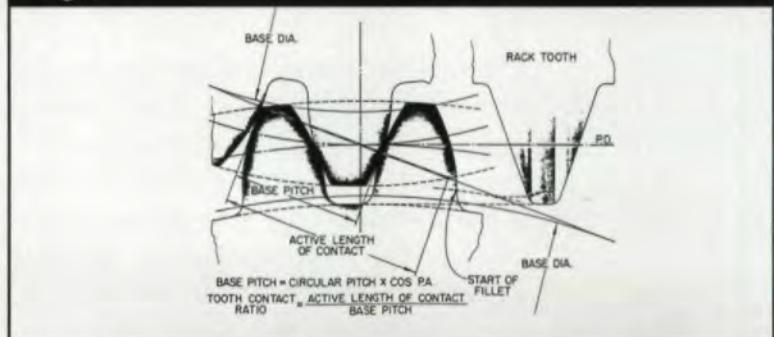

Fig. 7

Table 1 - Proportions for Establishing Depths and Radii on Round-Bottom Tooth Tools

COARSE PITCH SYSTEM	PRESSURE ANGLE	ADDENDUM	WHOLE DEPTH	TIP RADIUS
Full Round Bottom	14 1/2°	1/DP	2.440/DP	.534/DP
	20°	1/DP	2.335/DP	.427/DP
	25°	1/DP	2.250/DP	.317/DP
Pre-Shave Cutters	14 1/2°	1/DP	2.350/DP	.300/DP
	20°	1/DP	2.350/DP	.300/DP
Stubbed Depth Full Round Bottom	14 1/2°	.800/DP	2.000/DP	.550/DP
	20°	.800/DP	2.000/DP	.500/DP

and ships and generally on gears which are highly loaded. Round-bottom teeth are stronger than those with a standard generated fillet in spite of the fact that the round bottom is obtained at the expense of greater depth. The author recommends the proportions shown in Table 1 for establishing depths of radii on round bottom tooth tools.

Another suggestion is to use the full dedendum as a starting point for the radius. There are also designs to be found which call for a combination of several radii. Any combination, however, is only for the purpose of increasing the depth at the expense of the radius and, therefore, is contrary to the theory that the largest radius produces the strongest tooth, regardless of depth.

The main point is that round-bottom teeth must be designed from the tool, either hob or shaper cutter. It is the teeth of the generating tools which are provided with full radii, which, in turn, cut fillets of almost circular contour.

In the interest of strength, it is also a practice, on ground gears, to leave the fillets unground. In such cases, hob teeth are provided with round tops and protuberances equalling the amount of grinding stock. In subsequent grinding, the involutes are blended with the fillets.

With all these maneuvers to obtain strength and accuracy, care must be taken that the active involute profile is maintained without interference. Therefore, dimensions must be given, fixing the length of the active involute profile. These dimensions must be in such form that they can be read at the time the involute is checked.

Involute checking is done on fixtures using interchangeable base circles. If they do not use actual base circles, they have a mechanism which produces the identical effect of a gear rolling on its base circle over a straight edge. The indicator finger is attached to the straight edge and registers any variation between the

actual and theoretical involute.

Any point on the involute is therefore determined by a definite amount of angular roll of the gear. While this system is the more common today, it suffers from the disadvantage that equal increments of angular roll do not represent equal lengths along the involute. The alternate method of defining points on the involute is to divide the straight edge into equal parts of .050" called "scale readings." Then, at any given point of rotation of the gear, the scale reading on the straight edge is noted. These scale readings represent equal increments along the line of action and are directly proportional to the length of the involute on the gear tooth being inspected. A complete gear drawing should show, in degrees of roll or scale reading, the minimum start of involute. (See Fig. 9.)

If mating gears are to go together, their tooth thicknesses must be held. The figures for thickness include a definite allowance for backlash. There are recommended standard allowances for backlash. It is approximately 5% of the tooth thickness per gear. Pitch line tooth thicknesses can be measured by calipers. They are, however, difficult to operate and not particularly accurate. It is better to express the tooth thickness measurements in the form of block readings. These readings should have tolerances which take into consideration the requirements for the gear and the possibility of maintaining them.

The best designed gear may be an absolute failure unless a definite grade of workmanship is maintained. This means that certain tolerances for spacing, involute, runout, straightness, or helix angle must be held. The importance of accuracy is immediately apparent from a study of the line of action picture. The tooth contact ratio figure of 1.4 or more is entirely fictitious if the following tooth does not engage its mating tooth at the proper time. Errors are suddenly

picked up when the preceding tooth goes out of action. The result is noise and wear on the teeth. The higher the speed, the greater the noise and wear due to these errors.

The same effect is created through involute errors and through runout which results in slowly increasing or decreasing spacing errors. All errors result in noise, wear, vibration, and uneven running. Errors in helix or helical gears or straightness on spur gear teeth result in reduced areas of contact. The same applies to misalignment in mounting.

Gear tolerances, with the possible exception of the tolerance on readings over blocks, are not given for the purpose of interchangeability. A high-speed gear made with excessive errors is like having loose gibs in a shaper or play in a grinding spindle. Excessive inaccuracies ruin the purpose of the gear. The designer is, therefore, vitally interested in tolerances and will want to specify them on his drawings.

The specification of tolerances must take into account the ability of the manufacturing process to live up to them. There is no point in calling for .0002 error in spacing and involute if the gears are only shaped and subsequently heat-treated. Tolerances are a compromise between what is wanted and what can be produced. Additional finishing operations like shaving, grinding, lapping, and burnishing, are developed for the purpose of obtaining accuracy. Any manufacturing concern with the latest available finishing equipment and hobbing and shaping machines in good repair is bound to be able to make a much better compromise between theoretical perfection and reality.

Gear errors are not only the result of machines and manufacturing processes. Tools also introduce errors. There are limits to which hobs, shaper cutters, and shaving cutters are made. Limits for hobs are stated in the form of "AA," "A," "B," "C," and "D" tolerances, and tools are guaranteed to be within them.

While there is a limit to the accuracy to which gears can be made, and while these limits may vary between companies and the type of work, it is, in all cases, essential to check the gears on suitable equipment. A good design and a good drawing are essential, but the ability to live up to the drawing is equally necessary. A complete inspection report, plus a drawing, will tell every gear engineer all he would want to know in order

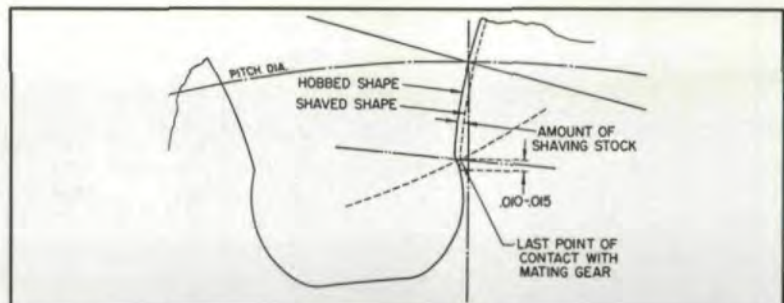

Fig. 8

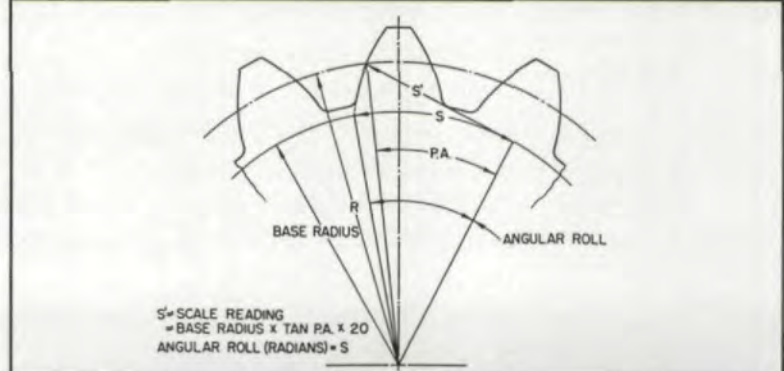

Fig. 9

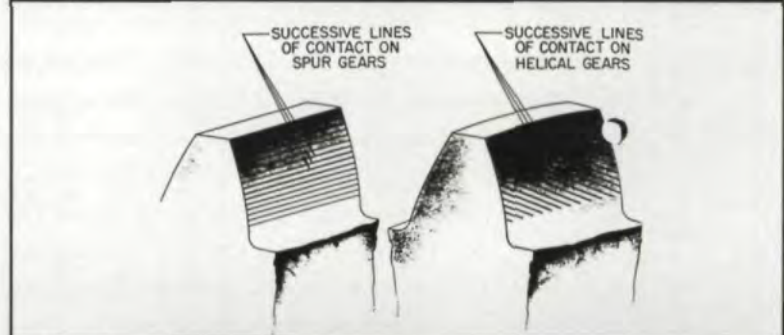

Fig. 10

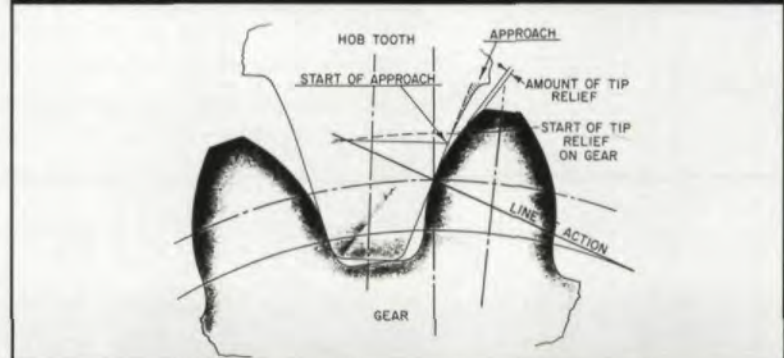

Fig. 11

to pass judgment on the gear.

The various methods of inspection are a subject in themselves. They extend from rolling fixtures and gear charters, which give a quick overall picture of the gear, to the various machines which break down the errors: the involute, spacing, helical lead, and runout checking instruments. Also part of the same picture are the checking instruments for the tools: the hobs, shaper cutters, and shaving cutters.

Gear performance and gear noise are the

direct result of design and production accuracy. However, it is well known that helical gears run smoother than spur gears. This is due to the gradually developing nature of the contact between involute helicoids. The active part of the line of action is greatly increased through the helical arrangements of the teeth, and there is never any trouble obtaining the minimum requirements for tooth contact ratio. (See Fig. 10.) Helical gears should be so designed in width and helix angle that the action of the pitch line helices alone provides for complete carry-over action from one tooth to another.

The line of action diagram for helical gears is the same as that for spur gears. The section to be shown is that of the transverse plane. Of course, all calculations take place in that plane also.

Another way to reduce noise and smooth out the action of the gears is to relieve the involutes slightly near the tip of the tooth. This is done particularly on hobbled, shaped, and shaved gears, but not on all ground gears. All standard full depth, course pitch, gear generating hobs are made to cut a small amount of tip relief. The effect of the tip relief is to let the driven gear lag slightly and, thus, pick up gradually any spacing errors which might be present. This action of the tip relief would, of course, be nullified by an opposing involute which is "fat" at the bottom. However, shop men know how detrimental a "fatness" at the base of the tooth is and usually stay away from it. (See Fig. 11.)

The effect of the tip relief is not shown in the line of action diagram. However, it is one of the reasons behind the recommendation of 1.4 tooth contact ratio, because tip relief takes effect in that region.

A method of providing for errors in alignment and resultant corner bearing is "crowning." Crowning is to alignment errors what tip relief is to spacing and involute errors.

Most gears merely serve the purpose of transmitting motion evenly and quietly, giving long wear. They are not particularly highly loaded nor subjected to high speed. If proportioned well and correctly designed, as previously explained by line of action diagram, they will serve their purpose. Proportioning means exactly that process which is followed daily by thousands of designers in laying out machinery where it would be inexpedient and sometimes impossible to justify every dimension by calculation.

A designer has many gear applications in front of him which may guide him in his selection of the pitch. Gears for rolling mills and heavy presses are from 1 1/2 to 5 D.P.; diesel and heavy motor drives are from 4 to 8 D.P.; tractors and trucks from 5 to 10 D.P.; light trucks and automobiles from 8 to 16 D.P.; timing gears and change gears from 10 to 20 D.P.; and small gears from 16 to 24 D.P. Then comes the whole list of fine pitches for instruments, business machines, and calculators. ■

Acknowledgement: Presented at the AGMA 19th Annual Gear Manufacturing Symposium, April 7-9, 1991, Chicago, IL. Reprinted with permission.



See us at GEAR EXPO '91
Booth #644



Standard Involute
Special Forms
Spline & Serration
Multiple Thread
Shank Type

GEAR GENERATING TOOLS

12 Pitch & Finer **HOBS** ALL BORE SIZES

TRU-VOLUTE PVD GOLD
Titanium-Nitride Coated Hobs & Cutters
(A selected range available from stock)

Catalog available upon request

Shaper Cutters
Disc Type · Shank Type
Rack Milling Cutters
Thread
Milling Cutters

RUSSELL, HOLBROOK & HENDERSON, INC.

TEL.: (201) 670-4220

2 NORTH STREET, WALDWICK, NEW JERSEY 07463

FINE MACHINE TOOLS SINCE 1915

FAX.: (201) 670-4266

CIRCLE A-25 on READER REPLY CARD

The Oerlikon MAAG "Opal 420" CNC Gear Grinder for the 90's

New Technology brings cost effective high precision (AMGA 14 +) gear grinding capability to a major aircraft & transmission gear producer

Arrow Gear Company of Downers Grove, IL, recently purchased the first *Oerlikon MAAG Opal 420* CNC Helical gear grinder to be delivered to a U.S. company. After extensively evaluating their high precision aircraft gear grinding requirements **Arrow** determined that the *Opal* offered the right combination of flexibility, accuracy and productivity for their varied jobbing shop needs.

By applying new dressable abrasive technologies, user friendly-highly powerful gear geometry software and JIT production capabilities, the *Opal 420*, offers numerous performance and cost advantages over other helical gear grinders using either generating or form grinding methods. Since the *Opal's* introduction it has achieved outstanding acceptance by producers of aircraft gears, off road vehicles, and power transmissions in England, Europe, and Japan.

Arrow Gear chose the exceptionally featured *Opal* CNC helical form gear grinder because it was ideally suited for their gear grinding applications which require frequent changeovers, involute modifications, and easy, time saving setups. Equipped with an integral computer controlled wheel dresser and long life diamond dressing disk for maximum flexibility and cost effectiveness, the *Opal* has the ability to best utilize recently developed dressable ceramic abrasives and newly improved vitrified CBN technologies for maximum grinding performance at a fraction of the cost of electroplated CBN wheels. Form modifications are quick and simple allowing immediate changes of gear geometry to correct for hobbing variations or heat treating distortions.

When required, the *Opal* can also utilize electroplated CBN wheels for additional versatility on specific gear grinding applications where these wheels can be proven to be cost effective and justifiable. **Arrow** can thereby select and

employ the optimum grinding abrasive and most economical process to suit their production, finish and quality requirements. With the *Opal*, gear geometry can be developed and verified with dressable abrasives before a commitment is made to manufacture expensive and dedicated electroplated CBN form grinding wheels.

For added versatility the *Opal* can be fitted with a choice of three interchangeable variable speed spindles. With wheel diameters ranging from 9.5" down to 1" it can accommodate most aircraft gear cluster configurations. While for automotive and various power transmission gearing, the standard self-balancing 20 HP spindle is also capable of creep grinding with high rates of metal removal and fine surface finishes.

The *Opal* can also be programmed to grind tooth flanks independently of each other when grinding gears with non symmetrical crowned leads, rolling dies or shaving cutters. Additional software can also be provided for conformal, epicyclic, or other non-involute forms.

Another exclusive feature which **Arrow Gear** intends to utilize, is the *Opal's* ability to calculate, anticipate, and correct the involute and lead ("Helical Twist") inaccuracies that occur when grinding "crowned helical gears". The *Opal*, by modifying the wheel geometry, helix angle of the wheel, and combining the rotational and radial movements of the gear and wheel during grinding, will automatically correct these common gear profile errors.

With features such as these and many others the *Opal 420* is indeed the **CNC gear grinder for the 90's**. If you would like additional information about this unique gear grinder please call, American Oerlikon Gear Machines, Inc. at 1-908-238-2300 or fax #1-908-238-2385 and ask for Ray Mackowsky, Vice President—Parallel Axis Gear Products.

SEE US AT



Introducing the Oerlikon - MAAG Opal 420

SEE US AT



WITH INTEGRATED WHEEL DRESSER

*"THE GEAR GRINDER OF CHOICE
FOR TODAY'S VARIED HIGH PRECISION
AND HIGH PRODUCTION REQUIREMENTS."*

- Use Dressable
- CBN Wheels
 - SG Wheels
 - Direct Plated CBN Wheels



- ◆ 3 Grinding spindles available
- Wheel speeds 2000 to 24000 RPM
- Std. Spindle 20 H.P.



On Screen Optimization

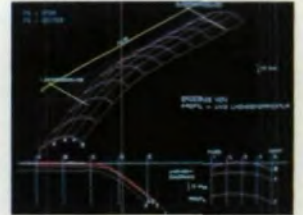

of Profiles and Crowning

Rotary and Lineal Crowning

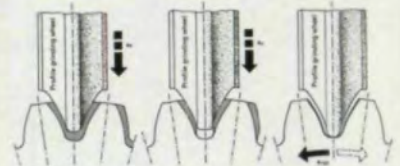

Double Flank Grinding

Single Flank Grinding

Review Your Choices
for
Flexibility - Productivity - Accuracy



Versatility



33 Teeth — 3.1 D.P. — 4" Face — 11.7" Dia. — 20° P.A. — 20° Helix
Mat. 10 Ni Cr Mo 7G — Case hardened to 60RC
Ground with Tip Relief & Lead Crown

AGMA 10
Tot. Grind w/dressing
5.2 min.

AGMA 13
Tot. Grind w/dressing
10.7 min.

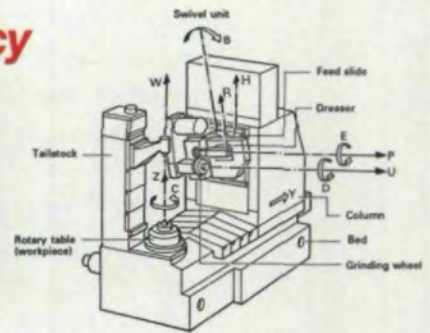

CALL (708) 810-0050 FAX (708) 810-9899
5021 Chase Avenue . Downers Grove, IL 60515



◆ Photo courtesy of IPE, Inc., Barrington, IL
CIRCLE A-64 on READER REPLY CARD

FALL
TECHNICAL
MEETING-OCT 23-25
See AGMA ad Page 54

AGMA GEAR EXPO



The World of Gearing

OCTOBER 20-23, 1991
DETROIT, MICHIGAN

For More Information Contact:

AGMA Headquarters
1500 King Street, Suite 201
Alexandria, VA 22314
703/684-0211

CIRCLE A-13 on READER REPLY CARD

A M A T T E R O F I N T E R P R E T A T I O N

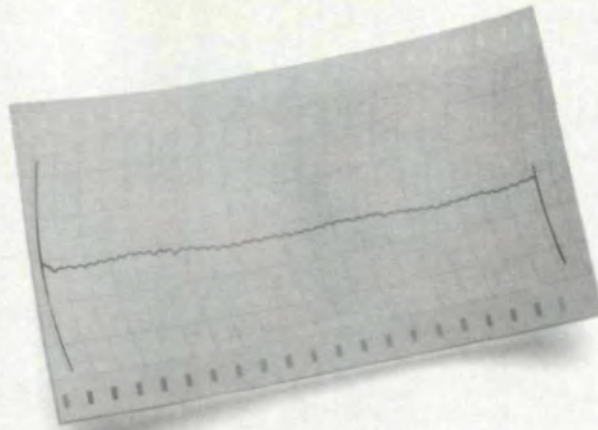

Is this a good gear
or a piece of scrap?



Now there's a way
to know for sure!

Subjective judgements about gear tests can cost you a bundle in scrap, assembly problems or warranty charges.

This is the way you should be testing gears – by the numbers with complete documentation. And now you can – simply and easily. Just retrofit your existing double-flank rolling gear tester with a Hommel Z-2000 computer/recorder. Or upgrade to an entire new Hommel gear testing system.



Either way you get the quantitative analysis and documentation you need to do the job right.

Write to Hommel America
(formerly Valmet, Inc.), 30 Peter Court,
New Britain, CT 06051.
Or call (203) 827-8500.
FAX: 223-2979.

HOMMEL
AMERICA

World class measurement technology

Taming The Autocratic Boss

C. Raymond Rogers

Dictatorships can be stifling. In an autocratic organization, employees seldom participate in decisions that affect them. By establishing a collaborative environment, you allow everyone to play a role in making your organization a success.

Three different organizations in three different situations achieved the same results. What was the common denominator?

In one facility, first-time-through capabilities went from 89% to 98.7%.

At the second facility, results from a J. D. Power Survey showed that customers rated a car built on a new line as No. 1 in its class.

At the third facility, the firm won the Malcolm Baldrige Award - five years after Tom Peters, co-author of *In Search of Excellence*, exalted the firm for establishing a new paradigm for manufacturing.

So what's the common bond among these three organizations? All three changed from operating with an autocratic environment to operating with a collaborative one.

Learn From Others

Organizations like the ones mentioned can teach us much that we can apply to our own organizations. For example:

- A collaborative organization needs a strong leader to get started.

- Leaders have to possess courage to change the things they can change, patience to accept the things they cannot change, and the wisdom to know the difference.

- Three areas must change for a company to become a collaborative organization: the behavior of the leader(s), everyday interactions, and the work environment.

When discussing the changes that need to occur in an organization - the environment, interactions, and leaders' behavior - skepticism that these factors are too much like apple pie and motherhood. The critics are absolutely right. The principles and concepts are so simple that hardly anyone fails to subscribe to them or to deny their importance. Getting organizations to change and to behave so that individuals feel they are part of the collaborative process,



MANAGEMENT MATTERS

however, is not simple.

Change Takes Time

The organizational metamorphosis from an autocratic to a collaborative organization takes time and patience. Leaders - union and management - in too many facilities are like little children on a trip asking, "Are we there yet?" The reality is that the moment a leader commits to changing his or her organization from autocratic to collaborative, the organization already is *there*. Organizational change is a process and a journey. The process creates the new environment. However, done piecemeal, getting to the place where individuals comment on collaboration by saying, "That's just the way we do things around here," will take five to eight years. If planned, the metamorphosis will take two

Managing a business in today's volatile economic environment is tough. Let "Management Matters" lend a hand. Tell us what management matters interest you. Write to us at P.O. Box 1426, Elk Grove, IL, 60009, or call our staff at (708) 437-6604.

C. Raymond Rogers

is vice-president at Kepner-Tregoe, Inc., a consulting firm based in Princeton, NJ, dealing with problem-solving and decision-making techniques for industry.

NOW CUT KEYWAYS AUTOMATICALLY

Mitts & Merrill PC/Hydraulic Keyseater

If you need more than 10 keyways cut each week, chances are very good a Mitts & Merrill PC/Hydraulic Keyseater can easily be justified.

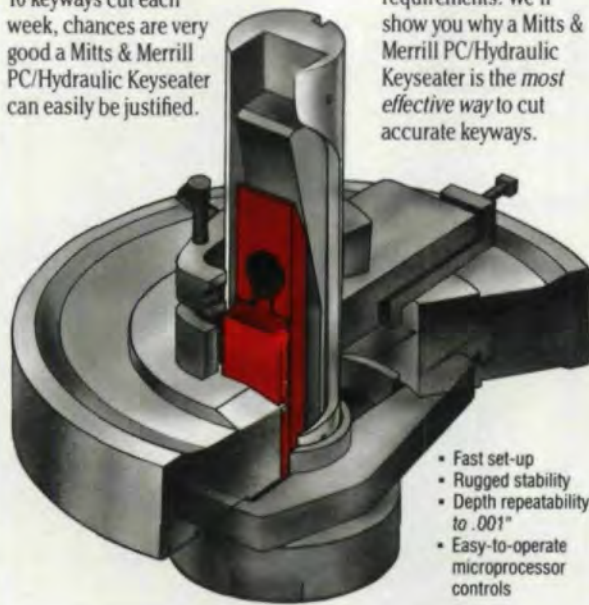

Let us know your requirements. We'll show you why a Mitts & Merrill PC/Hydraulic Keyseater is the *most effective way* to cut accurate keyways.

- Fast set-up
- Rugged stability
- Depth repeatability to .001"
- Easy-to-operate microprocessor controls

Mitts & Merrill
THE KEYSEATER COMPANY

P.O. BOX 195 • WATERTOWN, NY 13601 • PH (315) 629-3001, FAX (315) 629-3005

CIRCLE A-27 on READER REPLY CARD

SKIDMORE GEAR

WHEN IT COMES TO PRICE, AND EXPERTISE... "WE CAN CUT IT" OR "GRIND 'EM"

Spurs, bevels, helicals, worms, worm gears, splines and sprockets. 1/4" to 36" diameter with diametral pitch range of 120 DP to 3 DP. Complex parts and gear blanks made in minutes to exact tolerances on CNC equipment. 40 years of skill and experience: manufactured and inspected to A.G.M.A. standards. Send us your blueprints or call for a prompt, competitive quotation.

TOLL FREE
1-800-331-GEAR
TEL: 216/442-6670
FAX: 216/461-1888

SKIDMORE GEAR
5507 AVION PARK DRIVE
CLEVELAND, OH 44143

CIRCLE A-28 on READER REPLY CARD

to three years.

The first step in establishing a collaborative environment is defining what involvement will look like. This step includes determining what type of interactions will take place and what kind of behavior leaders will model on a daily basis. One way to get started is to use the accomplishments of collaborative organizations as benchmarks. To illustrate, following is a summary of what we have found in those companies that have made the change and now are saying, "That's just the way we do business around here."

Benchmarks of a Collaborative Organization

Have you noticed that when people enter a church their behavior changes? They become quieter. Likewise, our behavior changes when we enter a football stadium. We become louder. Employees' behavior changes when they enter a collaborative environment; they become more involved, interested, and dedicated.

Achieving a collaborative environment requires rethinking the current functional structures and information systems. In some facilities, creating small business units forces manufacturing, maintenance, and quality control, for example, to form new alliances. This new structure increases communication, enhances priority setting, and improves the measurements of quality, cost, and delivery.

One way to increase collaboration is to reduce functional barriers. And that in-

cludes barriers between engineering disciplines. In bringing about the desired change from an autocratic to a collaborative organization, an organization's engineering staff plays a critical role. For example, in many organizations, engineers influence equipment design and layout, parts design, and method of production, all of which impact the way workers and managers interact as they perform tasks.

Engineers need to collaborate, not practice their various disciplines in isolation and then "throw their airy ideas over the wall" for the next engineering group. One example of collaboration, *simultaneous engineering*, in which all engineering disciplines - including maintenance - work together, has made a difference in a number of organizations. This approach makes a great deal of sense. Yet for more than 50 years, most companies have not practiced it. Is it any wonder that facility managers, supervisors, and workers question an organization's sanity, when they are given parts that don't fit together easily or machines that don't run properly? Yet, these members of the organization are requested and required to *build quality*.

Simultaneous engineering, then, is a prime example of breaking down barriers. Similarly, for example, ad hoc groups of engineers, supervisors, and floor workers might focus on developing an ergonomically correct piece of equipment and, in the process, abolish tradi-

tional barriers.

Information systems must be altered in a collaborative environment. Most current systems are designed to provide information to the top managers. In a collaborative organization, information flows up, down, and sideways. The key question to ask is, "What information is required to ensure that a specific task meets 1) the required quality level, 2) the delivery of the quantities needed, and 3) acceptable cost parameters?"

In a number of collaborative environments, anyone involved with a machine has access to information about that machine. SPC charts,

making, the critical differences between an autocratic and a collaborative organization rest in the answer to two questions:

• *Who is involved?* The collaborative organization involves in a decision anyone who has information relevant to the problem. Furthermore, anyone with a problem involves anyone else whose commitment is required in order to ensure the successful resolution of the problem. For example, when a machine has a problem, an operator stays with the machine to answer critical questions from the maintenance technician. That way, the technician isolates the



A35 CNC Gear Hobbing Machine

Top Choice for Gear Hobbing

Mikron produces a complete range of high performance gear hobbing machines for fine and medium pitch gears. Machines are available for all stages of gear production, from single piece loaded to fully automated production set-ups with CNC

For 80 years, worldwide, Mikron has been the top choice as the single source for gear manufacturers that demand quality, precision, performance and service. Contact Mikron for solutions in gear hobbing.

Gear Machines and Hob Sharpeners



Mikron Corp. Elgin 1525 Holmes Road Elgin, IL 60123

Phone 708-888-0132
Telefax 708-888-0343

AGMA Show Booth #247

CIRCLE A-29 on READER REPLY CARD

MANAGEMENT MATTERS

**IN DECISION MAKING, THE CRITICAL DIFFERENCE BETWEEN AN AUTOCRATIC AND A COLLABORATIVE ORGANIZATION RESTS IN THE ANSWER TO TWO QUESTIONS:
WHO IS INVOLVED? HOW?**

process capability estimates, and data and task procedures are easily accessible. The information also is updated constantly as improvements are verified.

Problem Solving, Decision Making, and Planning

As regards planning, problem solving, and decision

cause of the problem more rapidly. Similarly, lift truck drivers provide ideas and recommendations about specifications before the company buys new trucks.

• *How are people involved?* Managers and leaders in a collaborative organization seek advice, opinions, and

COMPLETE GEAR MANUFACTURING SERVICES

Preferred Quality Supplier to Eight Major Corporations

- Spur and Helical Gears
- 1" to 16" O.D.
- Shafts up to 18"
- CNC Inspection of Gears and Splines
- Machine only or Complete
- Broaching
- CMM Inspection Capability
- Gear Grinding Ability
- 5 Pcs./100,000 Pcs. per month
- Assemblies or Loose Gears
- Crown Hob or Shave
- Precision Machining and Gear Blanking
- Precision Shafts and Splines
- Gerotors
- Shaper Cutting

Call today to discuss your specifications.



REEF-BAKER CORPORATION

50903 E. Russell Schmidt Blvd. Mt. Clemens, MI 48045
(313) 949-2520 Fax: (313) 949-3481

CIRCLE A-30 on READER REPLY CARD

AGMA FALL TECHNICAL MEETING 1991



October 23 — 25, 1991
Detroit, Michigan

For more information contact:

AGMA Headquarters
1500 King Street, Suite 201
Alexandria, VA 22314
Ph: 703/684-0211
Fax: 703/684-0242



CIRCLE A-31 on READER REPLY CARD

QUALITY GEARS

UP TO AGMA 15, MIL-I-45208A & MIL-STD-45662
FROM A SINGLE GEAR TO LONG RUN PRODUCTION, INCLUDING
PROTOTYPE & EMERGENCY REPAIR/REBUILD SERVICE
SIZE RANGE: FROM UNDER 1" to 48" DIAMETER

Reishauer Ground Gears
Most Type Gears Manufactured
Complete to Customer Specifications

- METRIC OR AMERICAN STANDARD
- SPUR, INTERNAL & EXTERNAL
- HELICAL, INTERNAL & EXTERNAL
- WORMS, WORM GEARS
- SERRATIONS • SHAFTS
- SPLINES, INTERNAL & EXTERNAL
- SPROCKETS • CLUSTERS
- SEGMENTS • SPINDLES
- RATCHETS • GEAR BOXES



Fully implemented SPC, and data communications capabilities, utilizing state of the art CMM's and M & M precision gear checker to 30" diameter to 18" face.



Fairlane Gear, Inc.

P.O. BOX 409, PLYMOUTH, MI 48170
(313) 459-2440

In Mich. 1-800-482-1773 • FAX (313) 459-2941

CIRCLE A-32 on READER REPLY CARD

concerns. They make decisions based on consensus much more frequently than do managers in autocratic organizations. Leaders in a collaborative organization know the value of honestly asking questions of and listening to the people who will be affected by a decision. However, in a truly collaborative organization, managers and leaders will use a full range of behaviors from making a decision alone to securing full consensus. The way they decide in a given situation will depend on the situation - on the needs of others for information, on maintaining everyone's commitment to the organization, on the impact of the decision on the development of people, and, of course, on time. Time, however, is the last consideration.

Managers' and Supervisors' Behavior

Herb Stone, facility manager at General Motors' Wentzville Assembly Plant and a proven collaborative manager, says, "I work harder, but enjoy the work more than [with] any other approach to management that I've tried." In a collaborative environment, managers and supervisors are both customer- and employee-driven. Clear differences exist in the way managers and supervisors behave when working in a collaborative rather than an autocratic organization. As one supervisor put it, "I used to spend my time enforcing compliance to procedures. Now I spend my time removing barriers between groups and eliminat-

ing excessive procedures." Another supervisor, commenting on his facility manager, put it this way: "Jim is constantly helping me understand what we have to accomplish and then asking me what I need to get the job done."

Leaders in a collaborative organization work at turning over power, information, and decision making to others. Developing skills of the team members is a high priority for each leader. Collaborative organizations highly reward coaching, which leads to skill improvement.

Mistakes in a collaborative organization are viewed as an opportunity to learn. They signal, not a need to punish, but a need for training, coaching, and counselling.

The End Result

In a collaborative organization, managers and supervisors have honed their coaching and counselling skills. Interactions are handled in a common-sense way, within the bounds of common courtesy. Objectives are shared, and the entire organization is caught up in a constant flow of energy toward accomplishing those objectives. Whenever a collaborative environment has replaced an autocratic environment, bottom line improvements in quality, cost, and customer satisfaction have been the end result. ■

©1991, *Engineering Digest*. Reprinted with permission. For more information about this column, circle **Reader Service No. 80**.

Just 2 of the *many* reasons to choose Mitsubishi Gear Cutting Machine Tools



#1 A small shop with big results

"We bought our Mitsubishi GB15 Gear Hobber based on the additional jobs it would allow us to handle. For example, we were recently able to take on a job for a transmission company -- a 10 key spline, 3-1/2" in diameter, 7- to 8-inches in length. The lead tolerance was 0.001" along the length of the spline. We've been meeting the specs and the deadlines--no problem.

"But in addition to the *new* jobs, it's also outperforming our conventional hobber at least 2-to-1! We get better turn-around and better overall quality. The solid construction and 5-axis controls make it one of the best machine investments we've got. Ever since we installed the new machine, we've been getting a steady stream of new work, and everybody's happy."

--Plant Manager at a small
precision gear producer



#2 A large company with no room for error

"We manufacture high precision electric motors and require tolerances of AGMA 8 and AGMA 10. We started working with the Mitsubishi GB10 Gear Hobber based on our earlier successes with their grinders. (We've just purchased our third and have had *zero* downtime attributable to the machine tool.)

"And the CNC is so easy to use we're doing virtually all of our programming right on the floor.

"But what we found most impressive about the Gear Hobber is the amazing ease of set-up and savings in changeover time. These days we can change from spur to helical gear in *1/4 the time* it used to take. That's saving us 75% in time, right up front. We can do very different gears, very fast, with exceptional quality."

--Manufacturing Engineer
at a leading manufacturer of
electric motors

This is...



MITSUBISHI
INTERNATIONAL CORPORATION
Machine Tool Division
1500 Michael Dr., Wood Dale, IL 60191
Phone: (708) 860-4220

CIRCLE A-33 on READER REPLY CARD

NILES Generating Gear Grinder

FAST SET-UPS AND CNC FLEXIBILITY

WMW:NILES – recognized around the world for excellence in spur and helical gear generating grinders. Only NILES lets you select from both high precision PLCs and field-proven CNCs equipped with electronic gear boxes.

The NILES CNC Gear Grinder eliminates change gears for faster set-ups, and automatically checks input data for correctness within permissible parameters. Plain language programming and a library of pre-programmed cycles further ease set-up and operation. Automatic wheel wear compensation and an optional 2- or 4-axis, CNC wheel dresser is available.

The NILES gear generating process is the fastest and most cost effective method for grinding small and medium production runs. Grinding quality to AGMA14 and better can be realized on gears with outside diameters from 24" to 137".

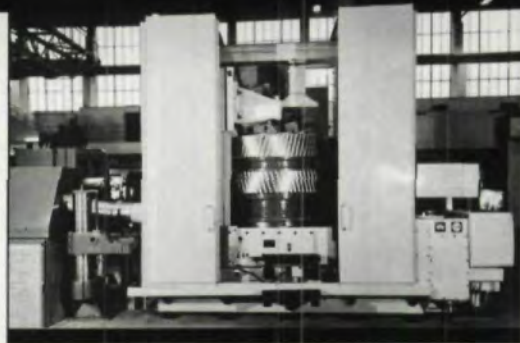

Visit us at
Booth #633



WMW MACHINERY INC.
570 Bradley Hill Road
Blauvelt, New York 10913
914 358-3330 • Fax 914 358-2378
Telex 4756017



CIRCLE A-9 on READER REPLY CARD

TRUE DIMENSION GEAR INSPECTION



Provides actual over ball/pin measurement of any helical or spur gear or spline without the need of costly setting masters.

Provides vital S.P.C. information.

Gage Division

United Tool Supply

851 OHIO PIKE • CINCINNATI, OHIO 45245 • (513) 752-6000

CAPACITY:

**9" O.D.
8" I.D.**

CIRCLE A-36 on READER REPLY CARD

Take the plunge

into the world of quiet gear technology.

We have the edge...

- Crown hobbing for noise reduction and misalignment compensation.
- Hard hobbing with carbide hobs after heat treat as a substitute for gear grinding.
- CNC hobbing and shaping alignment programs for varying teeth and pitches.

Forest City Gear...the most modern fine and medium pitch gear job shop in the world!

Come visit our plant where quality is our **Number One Product.**



FOREST CITY GEAR



Member of the
American Gear
Manufacturers Association

11715 Main Street • P.O. Box 80 • Roscoe, Illinois 61073 • 815/623-2168 • Fax: 815/623-6620

CIRCLE A-27 on READER REPLY CARD

Consistent Quality - Unbeatable Value

That is why LPG grinds with Okamoto Gear Grinders

LPG and its employees have long been dedicated to providing high quality gears to the Aero Space industry. The addition of the two Okamoto "Form Gear" grinders has enabled us to manufacture an even better gear more consistently and at a lower cost.

Both LPG and our customers benefit from this improved technology. Steve Shebelski, Foreman, Bill Wright, General Foreman, Thoompil Paul, Manufacturing Engineer, Mike Jovic, Gear Grinder.

Litton
Precision
Gear

*Designed, Built and Sold by the Group
That Can Solve Your Gear Grinding Problems.*



PEREZ MACHINE TOOL CO.

11 GINGER CT. • E. AMHERST, NEW YORK 14051 • TELEPHONE 716-688-6982

Exclusive U.S.A. &
Canadian Distributor of
Okamoto Gear Grinders
GTP-200 & GTR Series
Gear Tooth Chamfering
Machines

875 - 03

HTG

DETROIT, MICHIGAN
Gear
Expo
OCTOBER 20-23, 1998

Consistent Quality - Unbeatable Value

That is why Patterson Gear & Machine grinds with Okamoto Gear Grinders

Patterson has 4 Okamoto gear grinders in operation at this time with the latest being the addition last year of a new CNC SHG-360. Dependability and service are crucial to a plant running around the clock. Okamoto has more than filled the bill. The future at Patterson will include Okamoto.

Gene Mund, Production/Maint. Supervisor, and Bob Creger, Manager of Manufacturing.



PATTERSON GEAR & MACHINE, INC.

*Designed, Built and Sold by the Group
That Can Solve Your Gear Grinding Problems.*

PEREZ MACHINE TOOL CO.

11 GINGER CT. • E. AMHERST, NEW YORK 14051 • TELEPHONE 716-688-6982



Exclusive U.S.A. &
Canadian Distributor of
Okamoto Gear Grinders
GTP-200 & GTR Series
Gear Tooth Chamfering
Machines



DETROIT, MICHIGAN
Gear
Expo
OCTOBER 20-23, 1990

CIRCLE A-37 on READER REPLY CARD



*GEAR TECHNOLOGY IS
LOOKING FOR...
A FEW GOOD AUTHORS*

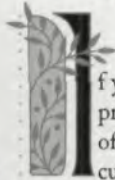

If you have an article on a technique, process, research project, or other idea of interest to individuals who buy or cut gears, please send it to us. Share your expertise with the industry. Send your completed article or an outline to GEAR TECHNOLOGY, P.O. Box 1425, Elk Grove Village, IL, 60009, or call (708) 437-6604 for a copy of our Writers' Guidelines.

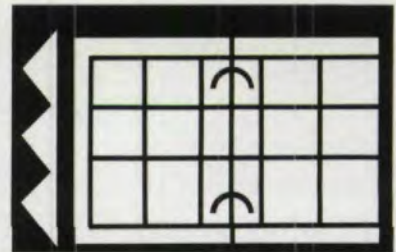

CALENDAR

AGMA Events

OCTOBER 21-25

Gear Expo '91 and Fall Technical Meeting.

Society of Manufacturing Engineers Events

For more information, contact Mike Traicoff, SME, One SME Drive, P.O. Box 930, Dearborn, MI 48121-0930. Phone: (313)271-1500. Fax: (313)271-2861.

SEPTEMBER 17-19

Advanced Gear Processing & Manufacturing. Holiday Inn Airport. Indianapolis, IN.

OCTOBER 14-16

Grinding Technology. Detroit MI.

Other Events

SEPTEMBER 10-12

Ohio State University. Three-day course on gear noise. For more information, contact Miss Carol J. Bird, OSU, (614) 292-3204.

SEPTEMBER 13-16

ASME 6th International Power Transmission and Gearing Conference. Marriott Camelback Resort, Phoenix, AZ. Contact: Allen G. Strandford, Jr., Conference Chairman, Dresser Rand, P.O. Box 560, Olean, NY 14760. Phone: (716) 373-3285. Fax: (716) 373-3715.

OCTOBER 22-24

American Society for Metals 13th Heat Treating Conference & Exposition. Cincinnati Convention Center. Cincinnati, OH. For further details write to: ASM International, Member Activities Dept., P.O. Box 473, Novelty, OH 44072-9901.

**If you perform custom
deburring/chamfering
operations...**

NEW!



...we have GREAT NEWS!

NOW there's a single machine...our new Model 300, that improves production rates, increases quality and lowers overall finishing costs. Highly flexible, the 300 will deburr or chamfer parts of all sizes and shapes...piston, cylinders, gears (even spiral bevel).

GMI Mutschler combines old world craftsmanship and state-of-the-art controls...for precise deburring/chamfering machines that meet or exceed metalworking shop requirements... worldwide. Let us build one for you...with the accessories and capabilities that match your needs...precisely. Call for FREE literature or detailed information.

GMI-MUTSCHLER

"Takes the edge off"

Ask for a free demo...no burrs attached!
Call (708) 986-1858 • FAX (708) 986-0756
CIRCLE A-38 on READER REPLY CARD

**See us at AGMA-Detroit
Booth #125**

Be sure to enter our "Take The Edge Off" drawing.

You are cordially
invited to learn from the
best who's been there

TW Illinois Tools

Gear Tool Specialists
3601 WEST TOUHY AVENUE
LINCOLNWOOD, ILLINOIS 60645
708-675-2100
1-800-628-2220 In IL. 1-800-628-2221

"The Gear School"

**OVER
33 YEARS**

of Service to the
Gear Industry.

The Society of Manufacturing Engineers (S.M.E.) has
approved this School for Professional Credits toward the
S.M.E. Recertification Program. Credits are awarded
on the basis of one credit per content hour.

GEAR TRAINING PROGRAM

1. BASIC FUNDAMENTALS

1. Gear History

- A. Cycloidal Teeth
- B. Involute Teeth
- C. Gear Cutting Machines
- D. Gear Cutting Tools

2. Gear Types

- A. Parallel Axis
- B. Intersecting Axis
- C. Skew Axis

3. Gear Ratios

4. Involute Gear Geometry

- A. Nomenclature
- B. Involutometry — Contract Ratio, etc.
- C. Helical Gears — Lead — Helical Overlap

5. Gear Tooth Systems

- A. Full Depth
- B. Full Fillet
- C. Stub Depth

6. General Formulae

7. Mathematics — (I.T.W. Trig Book)

2. HI SPEED STEELS

- A. Common Types
- B. Special Types
- C. Heat Treatment — Metallurgy
- D. Controls
- E. Surface Treatments
- F. Special Cases

3. CUTTING THE GEAR

1. Forming

- A. Milling
- B. Broaching
- C. Shear Cutting

2. Generating

- A. Shaping
 - a) Rack Type
 - b) Circular Type
 - c) Machine Types and Manufacturers

- d) Schematic — Principles
- e) Speeds — Feeds
- f) Machine Cutting Conditions

B. Hobbing

- a) The Hobbing Machine
- b) Types and Manufacturers
- c) Schematic — Differential and Non-Differential

- d) Speeds — Feeds
- e) Climb Cut — Conventional Cut
- f) Shifting — Types

3. The Hob as a Cutting Tool

- A. How It Cuts
- B. Tolerances and Classes
- C. Multiple Threads
- D. Hob Sharpening and Control
- E. The Effect of Hob and Mounting Errors on the Gear

4. The Shaper Cutter as a Cutting Tool

- A. Know Your Shaper Cutters
- B. Design Limitations
- C. Sharpening
- D. The Effect of Cutter Mounting and Errors on the Gear
- E. Manufacturing Methods

5. Tool Tolerance Vs. Gear Tolerance

- A. Machining Tolerances
- B. Gear Blank Accuracy and Design Limitations

4. FINISHING THE GEAR

1. Gear Finishing — Before Hardening

- A. Shaving
 - a) The Shaving Cutter
 - b) Types of Shaving — Conventional, Underpass, Diagonal
 - c) Crown Shaving
 - d) Shaving Cutter Modifications
 - e) Co-ordinating Tool Design— The Shaver and Pre-Shave Tool
 - f) Re-Sharpener
 - g) Machines

B. Rolling

2. Gear Finishing after Heat Treat

- A. Honing
- B. Lapping
- C. Grinding
 - a) Methods — Formed Wheel-Generating — Threaded Wheel
 - b) Machine Types

5. GEAR INSPECTION

1. Functional

- A. Gear Rollers
- B. Gear Charters
 - a) Reading the Chart
 - b) Tooth-to-Tooth Composite Error
 - c) Total Composite Error
- C. Master Gears
 - a) Tolerances
 - b) Designs
 - c) Special Types

2. Analytical

- A. Size — Tooth Thickness
- B. Runout
- C. Spacing
- D. Lead
- E. Involute

3. Automatic and Semi-Automatic

- A. How They Work
- B. What Can Be Checked
- C. How Fast

4. Chart Interpretation — Analytical and Functional

- A. Reading the Charts
- B. Which Errors Affect Other Elements
- C. How to Correct the Error the Chart Shows

6. INDIVIDUAL INSTRUCTION AND SPECIFIC PROBLEMS OR PLANT TOUR

This Program is flexible and changed to meet the needs of each group.

The 4-day program consists of a coordinated series of lectures given by the Engineering, Production and Inspection staffs of Illinois Tool Works Inc. They represent over sixty years of experience in gear and tool specialization.

The sessions are conducted with a technique and approach that leads to interesting discussion and participation. Starting with the basic fundamentals, the program is directed into those areas of greatest interest and value to the people attending the particular session. The groups are kept small so that this object is readily accomplished.

As mentioned, the planned program lasts four days. One-half of the fourth day is for individual discussion of specific problems in a detailed manner with members of the Illinois Tool Works' staff.

More than 4,000 individuals from hundreds of companies representing manufacturing, engineering, inspection and management, have come to Chicago for these programs. They have been conducted on a monthly basis since 1958. Classes have also been conducted in Europe. We are certain that this well rounded program has helped all of them to a better job and also given them a better understanding of engineering, manufacturing and inspection.

All those attending are assigned to the same hotel. This promotes friendly contact and discussion of mutual problems and interests. Tuition for the course includes transportation from the hotel to ITW and back, one group dinner, all continental breakfasts and all lunches.

We hope we may include your company in one of our Training Programs.

CIRCLE A-42 on READER REPLY CARD

ITW ILLINOIS TOOLS A Division of Illinois Tools Works Inc. 1992 GEAR TRAINING PROGRAM Four Day Seminars

Jan. 20—23	May 11—14	Sept. 14—17
Feb. 17—20	Jun. 15—18	Oct. 12—15
Mar. 16—19	Jul. 13—16	Nov. 16—19
Apr. 13—16	Aug. 17—20	Dec. 7—10

TUITION FEE: \$695.00

NOTE! Additional students, same company, same class \$650.00

Includes the transportation from the hotel to ITW and back, one group dinner, hospitality meeting, continental breakfasts, and all lunches.

The Society of Manufacturing Engineers (S.M.E.) has approved this School for Professional Credits toward the S.M.E. Recertification Program. Credits are awarded on the basis of one credit per content hour.

For additional information contact:

ROBERT H. MODEROW, Manager Training
708-675-2100 1-800-628-2220 In IL. Call: 1-800-628-2221

Visit Us Gear Expo. Booth # 627.

SERVICE

Gear Research Institute

An Institute of ASME and AGMA

A Developer of Gear and Power Transmission Technology

• **Cooperative Pre-Competitive Research**
Current Programs: Aerospace, Vehicle and Industrial, Worm

• **Multi-Client Topical Research**

• **Individual Client Research**
Rating Reviews, Testing (Gears, Contact Fatigue, Bending Fatigue, Wear), Problem Solving, Etc.

• **Consulting**
Staff, Experts Directory

• **Membership**
Bloc Fund Programs, Corporate, Individuals

A Non-Profit Activity in Support of U.S. Gear Producers. Write or Call for Information. Memberships Available.

Location: 1944 University Lane
Lisle, IL 60532
708/241-0660 FAX 708/241-0662

CIRCLE A-48 on READER REPLY CARD



SPIRAL BEVEL GEARS

- * Range up to 16 mod - 850 mm dia.
- * Machine with special large spindle bore 8"
- * Small batch quantity
- * Early delivery
- * Angular spiral bevels
- * Formate cutting of large diameter gears for prototype
- * Redesign of spiral systems available
- * Maintenance requirement can be made from your samples
- * Can make drawing from sample

CALIFORNIA BEVEL GEARS INC.

1660 Mabury Road
San Jose, CA 95133
408-258-7212
fax 408-258-7335
Sales reps wanted

CIRCLE A-49 on READER REPLY CARD

GEAR INSPECTION

Repair, rebuild, or update your present instruments to new 1991 designs. We can improve your gear inspection capabilities.

With factory trained personnel, we certify, repair, and rebuild Illinois and Fellows, lead, involute tooth space, and gear characters.

We believe in prompt service and reasonable prices for our customers. Let us make your gear inspection instruments and chart recorders perform like new.

Manufactured Gear & Gage
P.O. Box 7155
Elgin, Illinois 60121
(708) 377-2496
Fax (708) 377-2546

CIRCLE A-50 on READER REPLY CARD

GEAR NOISE ELIMINATED

The century-old problem of gear noise has finally been solved! An ingenious new concept and the powerful new tool of computer simulation allow us to redesign gearing so there is no significant transmission error or dynamic increment at any load or any speed. Applies to all gear types. Gives involute spur gears that are quieter, smaller, and less costly than conventional helical gears. If you want the best, write or call for details and/or quotation.

Axicon Gear Company
P.O. Box 9122
Berkeley, CA 94709
(510) 843-8300

CIRCLE A-51 on READER REPLY CARD

PRECISION GEARS SPLINES & GAGES

- Internal/External Spur Gears and Splines to 15" in dia. and 36" in length, to AGMA 15.
- Helical Gears up to 12" in dia., Face Width up to 6", Overall Length up to 30", to AGMA 15.
- Operational Gear Grinding-Reishauer 300E and 301S.
- Quality System MIL-STD-45662 and MIL-I-45208.
- Master Gears/Gages.
- Vinco® B-1 Dressers/Splinedicators

TIFCO, INC.  29905 Anthony
Wixom, MI 48393
(313) 624-7900

CIRCLE A-52 on READER REPLY CARD

GEAR TESTING AND DESIGN FACILITIES

- GEAR DESIGN (NOISE - STRENGTH).
- ROTATING GEAR (TORQUE - SPEED CONTROL) TEST MACHINES.
- SINGLE TOOTH BENDING FATIGUE TESTING.
- STATISTICAL PLANNING - ANALYSIS.
- WROUGHT STEELS, SINTERED METALS, NON-METALLIC MAT'LS.
- CAD FACILITIES FOR LOW COST SET-UP.
- CUSTOM TEST MACHINE DESIGN.
- EXPERIENCED PERSONNEL.

PACKER ENGINEERING

708/505-5722, ext. 214
BOX 353, NAPERVILLE, IL 60566

CIRCLE A-53 on READER REPLY CARD

FELLOWS MEASURING AND MANUFACTURING EQUIPMENT

- * Total Field Service
- * Express Emergency Repairs
- * Complete Assembly Facility
- * Reconditioning/Rebuilding
- * New Retrofits/Design Updates
- * Technical Training Seminars

SEND YOUR INSTRUMENTS HOME

Factory Rebuilding in the same room where they were originally built

Precision Performance
Experienced and Accommodating
Certification to Mil-Standards
Aircraft Quality Instruments

Visit us at GEAR EXPO '91
Booth #439



Profile Engineering Inc.
100 River Street
Springfield, VT 05156
802-885-9176
Fax 802-885-3745

CIRCLE A-54 on READER REPLY CARD

GEAR TOOTH GRINDING SERVICES

- Production and Prototype Quantities
- Specialists in Gear Tooth Grinding
- Able to match delivery to your needs
- Gear Tooth Grinding Capacity to 27.5 inch pitch diameters
- All services to AGMA standards

CERTIFIED GEAR INSPECTION

PRO-GEAR COMPANY, INC.

23 Dick Road
Depew, NY 14043
Phone (716) 684-3811
Fax (716) 684-7717

Sales Reps. Wanted

CIRCLE A-55 on READER REPLY CARD

Correction

Careful readers of Mr. Yefim Kotlyar's article, "Reverse Engineering" in the July/August issue may have noted a lack of continuity between pages 37 and 38. It's not your glasses that need fixing; it's us.

In the past few months the GEAR TECHNOLOGY staff have entered the world of desktop publishing, and we have not quite mastered all the quirks of the system as yet. During the electronic transfer from the word processing program to the layout program several lines were "lost" from Mr. Kotlyar's article.

The effected paragraphs are reproduced below. The omitted words are underlined. We apologize for this error.

REVERSE ENGINEERING

"Another difficulty may be encountered during gear inspection. Unless an inspection machine can follow the material, it is likely that the machine will run out of probe deflection range before completion of the profile or lead inspection. However, one should not be discouraged from continuing into a second iteration, since the method employs the slope/evaluation ratio, rather than slope error itself.

Step 3 - Determining NDP, NPA, HA & PD

After determination of base circle diameter and lead, the traditional gear characteristics like normal diametral pitch (NDP), normal pressure angle (NPA), helix angle (HA), and pitch diameter (PD) can be calculated. Since the same gear can have numerous combinations of these characteristics, one of them should be assumed in order to calculate the rest. Depending on whether pitch diameter, helix angle, normal pressure angle, or normal diametral pitch is assumed, one of the sets of formulae shown in Table 1 could be used in order to calculate other traditional gear characteristics."

Mr. Kotlyar is Product Manager for the Pfauter-Maag Gear Measuring Center in Loves Park, IL. ■



HIGH NOON

* WESTERN COLLECTIBLES *

Bought & Sold:

★ Bridles	★ Belts
★ Buckles	★ Bolos
★ Clothing	★ Chaps
★ Bits	★ Spurs
★ Books	★ Saddles

(213) 202-9010 by appointment
(213) 202-1340 (fax)

CIRCLE A-40 on READER REPLY CARD

When Class A is the minimum requirement...

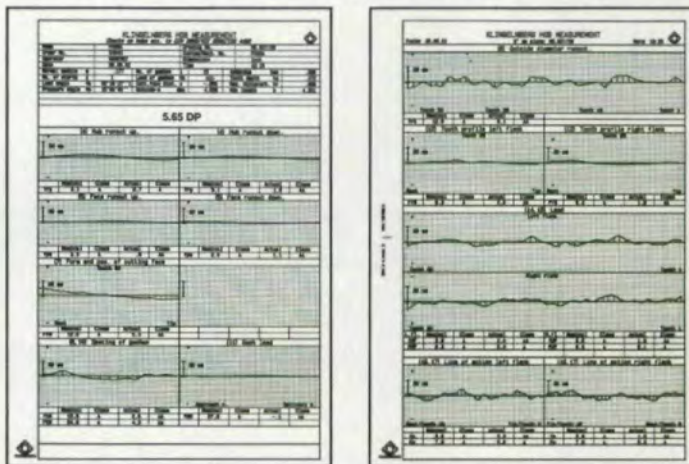

...insist on 100% verification.

Meeting customer demands for total quality requires hobs that meet the tests—every time.

GMI-FHUSA hobs, solid or inserted blade, are fully inspected with the latest Klingelnberg CNC techniques. It's your assurance and our guarantee of total quality.

Don't settle for less—specify GMI-FHUSA hobs!



GMI-FHUSA

Call (708) 986-1858 • FAX (708) 986-0756

CIRCLE A-39 on READER REPLY CARD

**See us at AGMA-Detroit
Booth #604**

CLASSIFIED

HEAT TREATING

Contour Induction Hardening Specialists

Spur, helical and bevel gears

Our gear hardening equipment includes 4 NATCO submerged process machines and 3 AJAX CNC-controlled gear scanning machines. We can also tool to meet any production need. Write for a free brochure.

American Metal Treating Company
1043 East 62nd Street
Cleveland, OH 44103
(216) 431-4492
Fax: (216) 431-1508

CIRCLE A-44 on READER REPLY CARD

GEAR CHECKING

NOW IS THE TIME FOR FINE
PITCH, HIGH ACCURACY GEAR
CHECKING EQUIPMENT

VARI-ROLL

- For the quality gear manufacturer and end user.
- High accuracy, composite gear testing for spur, helical, bevel and worm gears.
- Suitable for testing cut, ground, molded sintered, and die cast gears.
- Introducing gear inspection analysis software in Booth 242 at GEAR EXPO

PRECISION GAGE CO., INC.
6939 W. 59TH STREET
CHICAGO, IL 60638
312/586-2121
312/586-2159 FAX

CIRCLE A-45 on READER REPLY CARD

COMPUTER AIDS

Barber Coleman Hobbers: HELICAL GEAR SET-UP SOFTWARE FOR PC'S

Calculates exact index gears.
Calculates feed gears to .000001.
Runs in seconds. Send data for
sample output. PC DOS program
\$200 complete.

ANDREWS PRODUCTS, INC.
5212 Shapland • Rosemont, IL 60018
(312) 992-4014

CIRCLE A-46 on READER REPLY CARD

To advertise in
Gear Technology
call (708) 437-6604

HELP WANTED

DESIGN ENGINEER: \$50,000. Helical and Spur
PROCESS ENGINEER: \$55,000.
SR. PRODUCT ASSURANCE/QUALITY
ENGINEER: \$52,000. Aircraft Gears
MANUFACTURING MANAGER: \$75,000. Aircraft
Gears or Precision Machining.
Ann Hunsucker, Excel Associates
P.O. Box 520, Cordova, TN 38018-0520
(901) 757-9600 FAX (901) 754-2896

Manufacturing

GENERAL SUPERVISOR 1ST SHIFT

Milwaukee Gear is a rapidly expanding leader in the manufacture of precision gears. We currently have an opportunity with high visibility and advancement potential for a Supervisor in our Gear Cutting Department.

We require gear machinist experience as well as familiarity with all phases of the gear manufacturing process. Hands on experience with state-of-the-art equipment is preferred with knowledge of gear grinding a plus.

Our standards for quality are industry renowned - and in Milwaukee, that applies to a higher quality of life - with a low cost of living. Our wage and benefit package is excellent. For confidential consideration, send your resume with salary history to: Personnel Director, Milwaukee Gear, 5150 N. Port Washington Rd., Milwaukee, WI 53217-0615. An equal opportunity employer.

**MILWAUKEE GEAR
COMPANY INC.**

SERVICE



AMERICAN PFAUTER

Limited Partnership

Certified Inspection Services

Inspection Capabilities

- Parallel Axis Gears
- Worms
- Hobs
- Shaping & Shaving Cutters
- Circular Geometry
- Straight & Involute Splines

Computer Evaluation Capabilities

- Determination of Unknown Gear Geometry
- AGMA or DIN Determination
- Lead or Profile Modification Analysis
- K-Chart or Tolerance Band Analysis
- Cluster Gear Alignment
- Hobbing Set-up Adjustments
- SPC, Statistical Analysis of Results

American Pfauter L.P., 1351 Windsor Road, Loves Park, IL 61132-2698
Phone: (815) 282-3000 Fax: (815) 282-3075

CIRCLE A-47 on READER REPLY CARD

Rates: Line Classified - per inch - \$190. Classified Display - per inch (3" min.) 1X-\$150, 3X-\$140, 6X-\$130. Type will be set to advertiser's layout or Gear Technology will set type at no extra charge.

Payment: Full payment must accompany classified ads. Send check or Visa/Masertcard/American Express number and expiration date to: Gear Technology, P.O. Box 1426, Elk Grove Village, IL, 60009. Agency Commission: No agency commission on classifieds. Materials Deadline: Ads must be received by the 25th of the month, two months prior to publication. Acceptance: Publisher reserves the right to accept or reject classified advertisements at his discretion.

FORMASTER



CNC GRINDING WHEEL PROFILER

The Proof of the FORMASTER'S Accuracy and Versatility
is in the Finished Product

ACCURATE

$\pm .0001"$ (.002 mm)
guaranteed!

VERSATILE

Dresses nearly any
form in conventional or
CBN grinding wheels.

DURABLE

Totally sealed and air
purged, the FORMASTER
is well suited to production
environments.



EASY TO INSTALL

The FORMASTER'S com-
pact design makes it easy
to install on nearly any
grinding machine, usually
in less than a day.

EASY TO USE

Straightforward two axis
programming can be
learned quickly by
production personnel. P.C.
software is also available
for generating involute
gear profile programs.

Made in U.S.A. Patent No. 4,559,919

Normac, Incorporated
P.O. Box 69 • Arden, NC 28704
Phone (704) 684-1002 • Fax (704) 684-1384



Normac, Incorporated
P.O. Box 207 • Northville, MI 48167
Phone (313) 349-2644 • Fax (313) 349-1440



Mitsubishi Shapes the World of Gears...

When it comes to gear making, Mitsubishi offers it all. Hobbers, shapers and shavers. All CNC controlled, and all built for high speed, accuracy and reliability. Mitsubishi has become an innovator in gear manufacturing technology through research, testing and production.

For single-source, turn-key applications, Mitsubishi also manufactures gear hobs, shaper cutters and shaving cutters, as well as fixtures and automatic part loaders. Add to this the engineering support you'd expect from an industry leader, and you have true one source gear manufacturing supply.

The machines, the tooling and the engineering support. All from one source. All from the world authority on gear manufacturing—Mitsubishi.

For more information, call (708) 860-4222.



Heavy Duty Machine Tools



Machining Centers



FMS



Digitizer



CNC Lathes



Cylindrical Grinders



Special-Purpose Machine Tools



Gear Making Machine Tools



Precision Cutting Tools



Mitsubishi International Corporation

1500 Michael Drive, Suite E, Wood Dale, IL 60191 Phone: (708) 860-4222