

GEAR TECHNOLOGY



The Journal of Gear Manufacturing

IMTS '96 SHOW ISSUE—

SEPTEMBER/OCTOBER 1996

AISLE-BY-AISLE SHOW COVERAGE • IMTS TRAVELING COMPANION

P/M GEAR DESIGN • INSPECTION • STANDARDS

LUBRICATION OF LARGE, OPEN GEAR DRIVES

GEAR WEAR & CONTAMINATED OILS

PLUS • Addendum reports on The City of Really Big Gears

THE GEAR INDUSTRY'S INFORMATION SOURCE

KAPP - The intelligent gear grinding machine

Leave it to KAPP—the innovators of non-dressable CBN grinding wheel technology—to bring you the VAS 55 P, a 5-axis CNC gear grinding machine with optional VUS package for internal gears. It puts gear grinding using dressable or non-dressable wheels, intelligent wheel dressing, and in-process measurement into one high performance package.

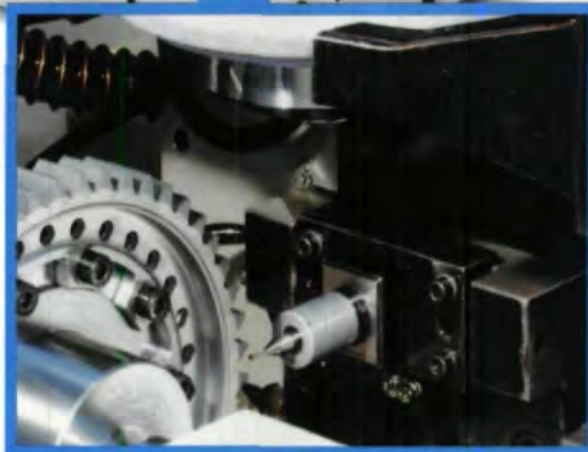

Critical gear tooth elements are measured by the Integrated Measurement System.

- **From non-dressable to dressable wheels.** In addition to KAPP's world-renowned single-layer CBN plated grinding wheel technology, the VAS 55 P CNC 5-axis machine also incorporates an advanced wheel dressing unit for dressable wheels.
- **CNC integrated measuring.** In-process inspection and stock removal measurement system helps optimize gear tooth profiles by measuring profile data after grinding and feeding corrective data to the dresser. Complete gear inspection and evaluation after finish grinding is also possible.
- **To KAPP it off.** Just call American Pfauter today at (815) 282-3000 to learn more about this new KAPP technology.



Information is fed back into the CNC for automatic correction by the dresser.

SEE AMERICAN PFAUTER AND PFAUTER-MAAG AT BOOTH #B1-6967

 **AMERICAN PFAUTER**

Limited Partnership

1351 Windsor Road
Loves Park, IL 61132-2698 U.S.A.

Phone: 815-282-3000
Telefax: 815-282-3075

CIRCLE 101 or call 1-800-340-1160 x9101

Pfauter-Maag Cutting Tools. Where the world goes for quality.

Manufacturers everywhere need new cutting tool technology that can produce parts faster, more accurately and less expensively than ever before. That's why more companies worldwide turn to Pfauter-Maag Cutting Tools for the best in gear hobs, shaper cutters, and form-relieved milling cutters.

At Pfauter-Maag Cutting Tools, we have people and plant resources unavailable anywhere else in the world. We can find the absolute best tooling approach for your application and help

put it to use more productively than you might have believed possible.

So turn to Pfauter-Maag Cutting Tools for the best in gear-cutting tools and form-relieved milling cutters.

Pfauter-Maag Cutting Tools

Limited Partnership

Telephone (815) 877-8900 • Fax (815) 877-0264
1351 Windsor Road, P.O. Box 2950, Loves Park, IL 61132-2950

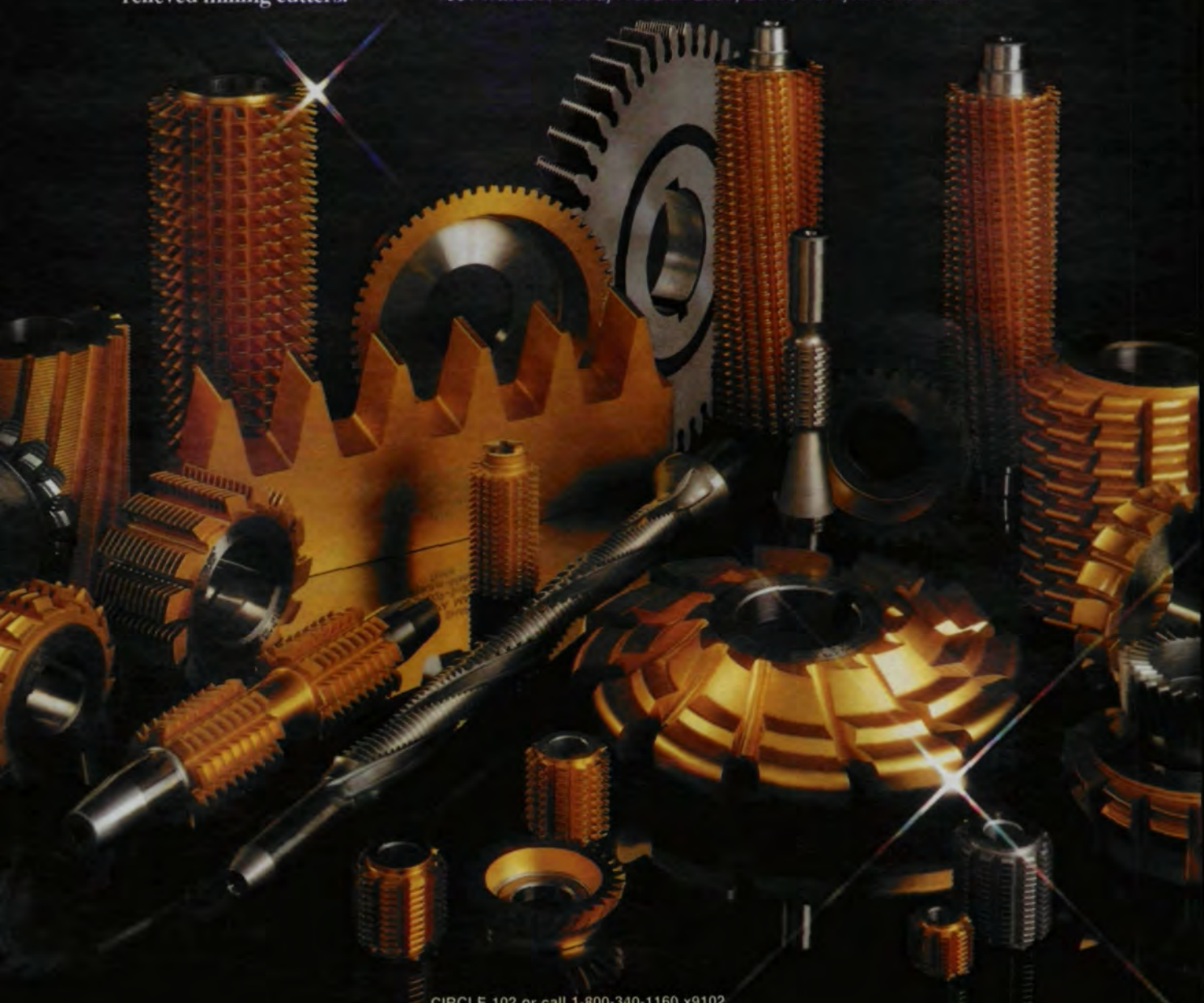

STAR PRECISION HOBS...

BECAUSE NOT ALL GEARS ARE CREATED EQUAL

COME SEE US AT IMTS, BOOTH #B1-7158.



The only way to get top quality gears, is to machine them with precision hobs. At Star Cutter, we utilize the most advanced technology available to insure that each of our precision hobs will deliver the exact performance you need — cut after cut, day after day.

Take advantage of our experienced engineering department to design and develop the most economical hob to meet your individual special unique gear manufacturing requirements. These hobs are available with Gold Star titanium nitride, titanium carbo-nitride and other advanced Gold Star coatings.

If faster-running, quieter and more accurate gears are your objective, you can't do better than Star. Call, write or fax for more information.



P.O. Box 376
Farmington, MI 48332-0376
810/474-8200 FAX 810/474-9518
CIRCLE 128 or call 1-800-340-1160 x9128

GEAR TECHNOLOGY

SEPTEMBER/OCTOBER 1996

The Journal of Gear Manufacturing

FEATURES



20

Tooth Modification & Spur Gear Tooth Strain

How changing the tooth profile affects dynamic strain.....20

Alternative Lubrication Methods for Large, Open Gear Drives

The best approach for your application.....26

Powder Metal Gear Design & Inspection

What you need to know now.....34

AGMA/MPIF P/M Gear Standards

Joint effort will yield first standard for P/M gears.....38

Gear Fundamentals Gear Wear and Lubricant Contaminants

Clean oil is essential for long wearing gears.....45

SPECIAL SECTION

IMTS '96

Gear lover's guide to the show and beyond.....11

DEPARTMENTS



56

Publisher's Page

The politics of denial.....7

Advertiser Index

Check this important page.....25

Industry News

People, places and things of note.....32

Technical Calendar

Events of interest.....40

New Products

What's new in the marketplace.....51

Classifieds

Products and services you can use.....54

Addendum

The gears of Cook County and other sagas.....56



Cover art
courtesy of
Fellows Corporation,
Springfield, VT

PERFORMANCE & QUALITY



AEROSPACE SPLINES
 HELICAL SHAPING
 CROWN SHAPING
 CNC SHAPING
 FACE GEARS
 GEAR HOBBING
 SPLINE HOBBING
 KEYSEATING
 CNC TURNING
 CNC MACHINING
 HELICAL BROACHING
 STRAIGHT BROACHING
 COMPLETE MACHINE SHOP
 EXOTIC ALLOY MACHINING
 GEAR INSPECTION SERVICES
 PROTOTYPE GEARS
 WITH FAST DELIVERY
 TOOTH CUTTING ONLY
 OR COMPLETE TO PRINT

LETTY

TECHNOLOGY CORPORATION
 P.O. Box 21 / 29 Industrial Park Road
 New Hartford, CT. 06057
 Phone: (860) 738-2525
 Fax: (860) 738-2455

CIRCLE 146 or CALL 1-800-340-1160 x9146

CONTACT US
 FOR A PROMPT
 QUOTATION.

YOU'VE FOUND:
 THE
 GEAR & SPLINE
 EXPERTS

GEAR TECHNOLOGY

The Journal of Gear Manufacturing

EDITORIAL

Publisher & Editor-in-Chief
 Michael Goldstein

Associate Publisher & Managing Editor
 James K. Spalding, CBC

Senior Editor Nancy Bartels

Associate Editor William R. Stott

Technical Editors
 Robert Errichello
 William L. Janninck
 Don McVittie
 Robert E. Smith

ART

Art Director Jean Bartz

ADVERTISING

Advertising Manager
 Patricia Flam

CIRCULATION

Circulation Coordinator
 Daniel S. Wachula

RANDALL PUBLISHING STAFF

President Michael Goldstein

Vice President Richard Goldstein

Vice President/General Manager
 James K. Spalding, CBC

Controller Patrick Nash

Accounting Laura Manion

Art Consultant Marsha Goldstein



VOL. 13, NO. 5

GEAR TECHNOLOGY, The Journal of Gear Manufacturing (ISSN 0743-6858) is published bimonthly by Randall Publishing, Inc., 1425 Lunt Avenue, P.O. Box 1426, Elk Grove Village, IL 60007, (847) 437-6604. Cover price \$5.00 U.S. Periodical postage paid at Arlington Heights, IL, and at additional mailing office. Randall Publishing makes every effort to ensure that the processes described in GEAR TECHNOLOGY conform to sound engineering practice. Neither the authors nor the publisher can be held responsible for injuries sustained while following the procedures described. Postmaster: Send address changes to GEAR TECHNOLOGY, The Journal of Gear Manufacturing, 1425 Lunt Avenue, P.O. Box 1426, Elk Grove Village, IL, 60007. ©Contents copyrighted by RANDALL PUBLISHING, INC., 1996. Articles appearing in GEAR TECHNOLOGY may not be reproduced in whole or in part without the express permission of the publisher or the author. Contents of ads are subject to Publisher's approval.

Retract.
Enter.
Release.
Read.
Comtorgage.



Checking internal spline diameters has never been easier.



External spline gage with built-in gage pins saves time and eliminates operator variability.

Comtorgages have always been known for their accuracy, durability and ease of use. The Comtorgage internal and external spline gages are no exception, especially where ease of use is concerned. By incorporating the appropriate gage pins directly into the construction of the Comtorgage, the need to hold the pins in place while taking a measurement is eliminated. A simple and effective "one piece" concept that saves time and eliminates possible operator variability. Highly repeatable and accurate measurements result. For this and all your high volume measuring needs... Comtorgage it!

Call (401) 765-0900 for a free catalog. Or write, Comtorgage Corporation, Industrial Drive, Slatersville, RI 02876.

comtorgage®

CIRCLE 156 or CALL 1-800-340-1160 x9156

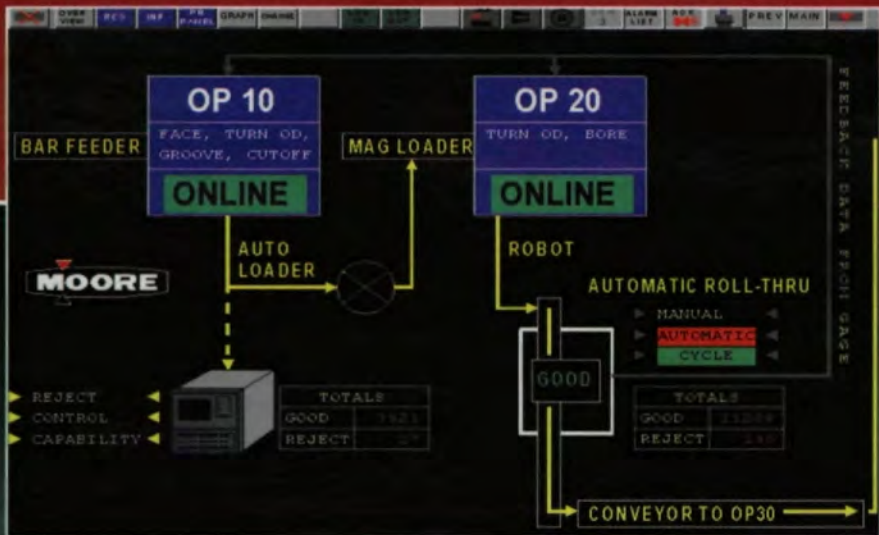

Only MOORE can help you set up very affordable process measurement & control

MOORE windows-based real-time monitoring system is available for integrating gaging and production equipment.

MOORE OFFERS THE INDUSTRY'S WIDEST RANGE OF FUNCTIONAL GAGING SYSTEMS FOR GEAR PRODUCTION

For high volume gear inspection systems, you can't beat Moore. Here's why:

MOORE Experience

Moore has been designing and producing high quality, reliable gaging systems for more than 50 years.

MOORE Technical Back-up

Moore's U.S. operations provides over 1,000 employees and a 375,000 sq. ft. manufacturing facility, full engineering services, plus additional operations worldwide.

MOORE High-end Electronics

Moore's Gaging Division draws on the technical skills and experience of the Moore Products Co., Instruments and Controls Division, which produces state-of-the-art computer systems and software for process control.

MOORE's Size

Moore is large enough to handle major programs and specialized enough to assure you personal attention.



Automatic tight mesh inspection system



Semi-automatic tight mesh inspection



Pitch diameter inspection gage



Modular gear blank fixture



Universal center distance gear checker



Manual roll stand

Call Or Fax The Moore Gear Gaging Experts Now

Tel: 1-215-646-7400 Ext. 2352

Fax: 1-215-653-0347

Attn: Gage Division, Gear Team



"The Measurable Difference"

Moore Products Co., Gaging Division
Sumneytown Pike, Spring House, PA 19477

CIRCLE 106 or call 1-800-340-1160 x9106

Our family of
gear machines
shares a name—



and a whole
lot more.

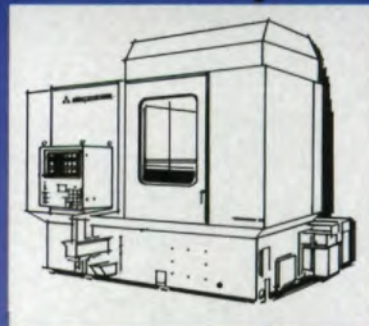
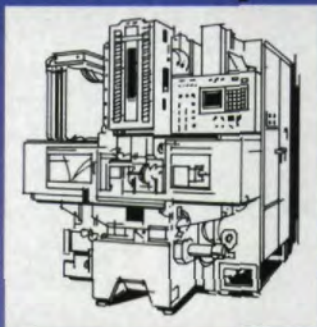
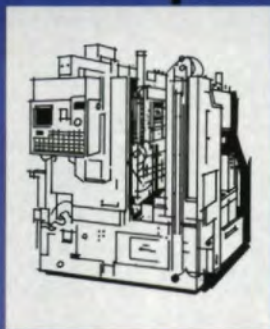
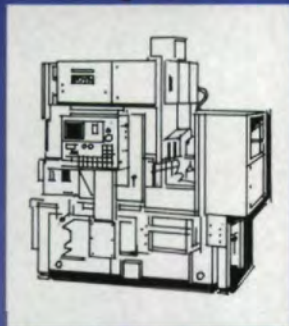

SHAPING

SD15CNC SC63CNC
SC25CNC SC100CNC
SC40CNC

Sophisticated cutting mechanisms give you high productivity for gear shaping needs up to 1 meter diameter.

HOBGING

GD10CNC GC63CNC
GD20CNC GC100CNC
GC25CNC GB-H18CNC
GC40CNC

Get high precision gears—up to 1 meter—with our gear hobbers—fast.

SHAVING

FB30CNC FA45CNC

Cut gears up to 450 mm fast, with simple set up and conversational programming on our gear shavers.

GRINDING

ZG400CNC ZG1000CNC

Our highly precise grinders give you gears that meet the highest world-class standards.

The most complete family of gear cutting machines share Mitsubishi machine construction, Mitsubishi software, and common controls. For the fastest CNC learning curves and the highest quality gears, contact your Mitsubishi representative today.

 **IMTS 96**
CHICAGO — SEPTEMBER 4 - 11, 1996

SEE US AT
BOOTH #D2-4254

This is...



**MITSUBISHI
MACHINE TOOLS**

MHI Machine Tool U.S.A., Inc.
907 W. Irving Park Road • Itasca, IL 60143-2023
Phone: (708) 860-4222 • FAX: (708) 860-4233

CIRCLE 107 or call 1-800-340-1160 x9107

The Politics of Denial

A good many things bother me about election years—the annoying sound bites, the negative commercials, the endless political over-analysis. But what bothers me most about the coming election is this: So far (when I'm writing this, it's admittedly early in the campaign) there's little or no talk about what is one of the most critical national issues of the next thirty years—our growing government debt.

With yearly deficits, sometimes smaller, sometimes larger, this debt is like the creature in the movie "Alien." It keeps growing bigger and bigger inside our country, sucking the insides out of our treasury, and one day, I fear, it will burst forth and bring catastrophe to our society.

But no one running for national office seems to want to say that—not in an election year. Our debt and its accompanying burden of interest payments, caused in large part by our "entitlements" programs, remains a political "third rail." Politicians touch them at their peril. Talk about a state of denial.

Deficit economics is a complicated business, but certain conclusions are clear. In the July 1 issue of *Forbes*, a little chart illustrates the inevitable course to which we are already committed. Right now only 18% of the federal budget is "discretionary spending." Everything else is taken up with entitlements and interest. By 2030, the numbers will read this way: 93.6% of the TOTAL federal budget will go to entitlements and interest and 6.4% for discretionary income (everything else).

The *Forbes* chart shows some other disturbing numbers. In 1995 government spending accounted for 21.7% of our Gross Domestic Product. Thanks to a budget our leaders have promised to "balance" by 2002, it will be down to 18.5%. So far so good, but look a little farther into the future. By 2010 it will be back up to 24.6% of the GDP, and by

2030, the total federal government take will be 37.3%. And these numbers don't include the additional 11% that states will take, assuming their spending remains unchanged for the next 35 years. In 2030, the federal deficit alone will be 18.5% of the GDP, (up from only 2% now), and of this 10.7% will be interest.

Some optimistic scenarios suggest that as baby boomers age and enter their peak saving years, these numbers will begin to magically fix themselves. But that's a false promise. According to the July 15 issue of *Business Week*, while these savings increases will add \$27.5 billion to annual personal savings, rising demand for health care among the aging will soak up the gains and then some. Medicare and Medicaid will cost more and more, pushing the deficit from \$164 billion in 1995 to \$376 billion in 2005. For every extra dime saved, the government will have to borrow 76 cents to meet its obligations.

The main culprit in these scenarios is that mass of "entitlements," (mostly, but not entirely, Social Security, Medicare and Medicaid) which we are already committed to paying out. We've created a giant Ponzi scheme where we're using the current payments (almost 15% of everyone's total earnings), which taxpayers believe are going to their retirements, to meet our obligations to present retirees. The present Social Security "surplus" is "loaned" to the Treasury to reduce each year's deficit. The Social Security system receives IOUs for this money, and it's left to the next generation and the vagaries of a future economy to pay back these loans.

Is it reasonable that people, regardless of their economic need, get back many many times what they put into the Social Security system and far more than they would get from the same money in any other investment? We've created a myth where people are "entitled" to this

"Everybody, sooner or later, sits down to a banquet of consequences."

Robert Lewis Stevenson



money, and now we're living with the consequences of it.

But soon we'll have no option but to face reality. Unchanged, our present course could lead to disaster within the next generation or two. In 1960 there were 5.1 taxpaying workers to support every retiree. By 2040 there will be 2, or possibly less.

This is a recipe for guaranteed generational warfare. At some point, those two future taxpayers, burdened with responsibilities for their own families and whatever other taxes they will have to pay, will say, "Enough! I won't take it any more! I'm not paying for these old geezers to sit around and play shuffleboard in Florida while I work three jobs to keep a roof over my head." At the same time, the "old geezers," understandably enough, will fight to keep their "entitlements" coming. It's not rocket science to figure out what that will mean for any sense of national unity.

But the scenario gets even worse. We already have very little left over after

GROUND GEARS



BY NIAGARA

When quality and time are critical.

Ground gears with the quality you demand for close-tolerance applications plus the turnaround you expect from conventional manufacturing.

Unheard of?

Then you've never heard of Niagara Gear.

We use the latest grinding wheel technologies and all electronic Reishauer gear grinders to reduce cycle times without sacrificing quality.

Our ground spur and helical gears:

- Result in less scrap and inspection time to reduce costs and production delays
- Meet your most demanding requirements for higher loads, faster speeds and quieter operation
- Never sacrifice quality and are manufactured to AGMA Class 15 with crowning

More than 80% of our customers are Fortune 500 companies. Let us quote on your next ground gear requirement and you'll see why.

FAX: (716) 874-9003

941 Military Road • Buffalo, NY 14217
TEL: (716) 874-3131



**GROUND GEAR
SPECIALISTS**

CIRCLE 135 or CALL 1-800-340-1160 x9135

PUBLISHER'S PAGE

meeting current obligations to do the other things we expect our government to do, such as provide for defense, maintain our position of leadership in the world, care for our physical infrastructure and educate our children and grandchildren. And as time goes on, we'll have less and less.

It's a cliché to say that election year is the time to send a message to Washington. Sometimes I wonder what the point is. Messages were sent in 1992 and 1994, and it didn't seem to make any difference. Our elected leaders are still "fixing" the problem by putting Band-Aids on our fiscal internal bleeding.

At the time I'm writing this, we're again confronted with the insanity of both presidential candidates promising tax cuts within twenty-four hours of the announcement that part of Social Security will be bankrupt in five years.

What's wrong with this picture?

Ultimately democracies tend to get the governments they deserve. If we have a government of men and women who won't confront the hard questions of the coming years, maybe it's because we encourage them not to. It's frustrating when the candidates try to buy the election with minor tax cuts, cheap temporary fixes and denial, mixed with polarizing statements and demonization of the opposition. Compromise seems to have become a crime, and decency and civility in public discourse have become aberrations. Purity has become more important than progress. On the other hand, if we don't demand something else, then that's what we'll get from Washington.

The message we have to send—and mean—is this: Acting responsibly to control the deficit and deal with "entitlements" (not just the other guy's, but all of ours) is not a political "third rail"; failing to do so is. The message should be, "If you can't tell the truth and put the long-term good of the country ahead of the short-term interests of yourself, your party and the influential special interest groups, then we'll find someone who will."

While "government" is often part of the problem, only we, through our elected officials, can balance its inflow and outflow of funds. We must act in a fiscally responsible manner in our personal

lives and in our businesses. Shouldn't we insist that our representatives be just as responsible when the question is government spending?

Fixing the deficit/entitlements mess won't be easy, but it's not impossible. It will mean, however, accepting some short-term pain for the sake of long-term gain; sacrificing some personal benefits for the sake of the general good; doing without present pleasures for the sake of our own and other people's children.

Our parents and grandparents and their parents for generations did it. It never occurred to them to do anything else. We can and must do it too. A country burdened with continuing deficits, low savings rates and an aging population will not remain economically healthy or politically strong.

We owe it to ourselves, our past and our future to get the debt under control: to ourselves because most of us will still be alive when the system starts to unravel; to our past because it was the self-denial and the dreams of our ancestors for us that have brought us the greatness and prosperity we're squandering away; and to our children because every day that we delay means more of the bill falls to them to pay. And that is neither right, nor fair, especially when they never agreed to accept the obligation in the first place, and when it's still within our power to relieve them of much of the burden.

I, for one, don't have all the answers. The exact means we use to solve the debt problem is an issue about which reasonable people may disagree. But we can't put off the question any longer.

There's no better time than an election year to remind ourselves and our elected officials that the real issue confronting us is not just "character" or "values," it's providing the leadership to deal with our crippling debt and enable us to become the kind of country we can and want to be in the next century.

Michael Goldstein,
Publisher & Editor-in-Chief

Any Tool. Any Time.

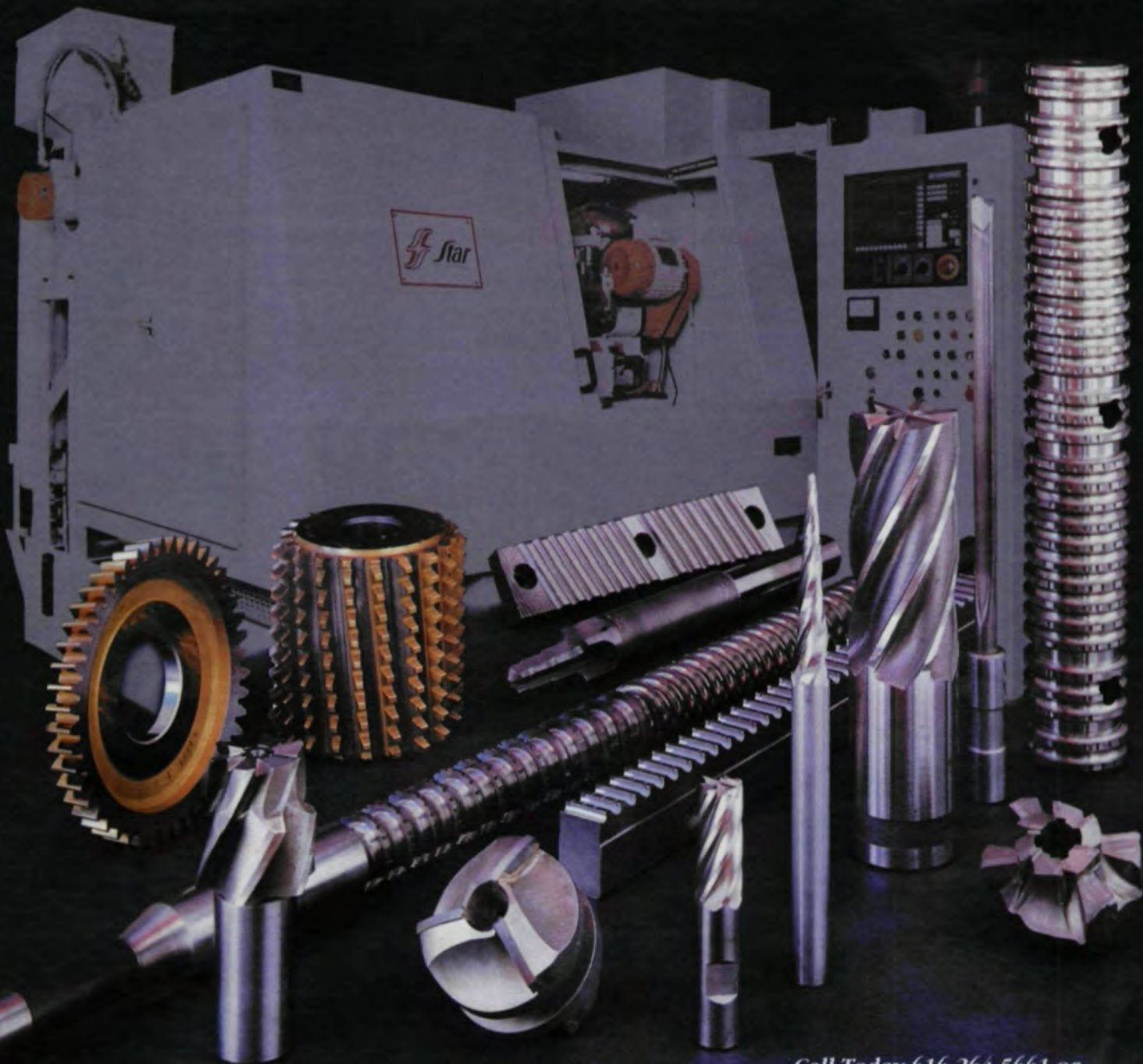

Star CNC Tool Grinders.

You have tools to grind and Star has a machine to grind them.

Any tool, from the smallest drill to the largest broach can be quality ground on Star CNC tool grinders.

The full line of operator-friendly Star CNC grinders are designed for dependability, accuracy and versatility.

Star's state-of-the-art machines feature glass scales, dual probe systems that

COME SEE US AT IMTS, BOOTH #B1-7158.

automatically locate tool features and grinding wheels, 32-bit processor controllers and a data handling system that provides virtually unlimited storage of grind programs and data files.

Our machines are also backed by the best training, service and warranty in the industry.

Star. The one to remember any time you have tools to grind.

Call Today 616-264-5661 or
FAX 616-264-5663

Star Cutter Company
Elk Rapids Engineering
210 Industrial Park Drive
P.O. Box 728
Elk Rapids, MI 49629

Since 1927
 **Star**
STAR CUTTER COMPANY

CIRCLE 132 or call 1-800-340-1160 x9132

THE NEXT GENERATION THREAD GRINDING MACHINE



More than a century's experience of world class machine tool design and manufacture has led to the creation of the next generation TG350E CNC Thread Grinding machine from Holroyd.

An outstandingly versatile and flexible machine, the TG350E can grind a wide range of helical forms, from low quantity prototypes to high volume production, with fast and efficient changeover between jobs.

- *User-friendly, with simple touch screen controls.*
- *New and powerful profile management software ensures consistent accurate profile grinding to microns.*
- *Digital scanning probe for 'in process' closed loop measurement of all key elements and automatic correction.*
- *Hardware and programming set up time reduced to a minimum.*
- *Hydrostatic bearings for increased stiffness for closer infeed control and higher accuracy.*
- *Workhead controlled by a high resolution AC digital servo system through a DIN 2 Standard Holroyd duplex worm & wheel. Position feedback is a direct mounted optical encoder.*
- *45kW grinding spindle motor.*
- *Slant bed design gives the TG350E a greater advantage in absorbing cutting forces and provides essential stability beyond conventional grinding machines.*

Holroyd is much more than simply another supplier of specialized machinery and components - it's customers receive a total service, thus ensuring that they take full advantage of Holroyd's unmatched wealth of application engineering knowledge.

"ENGINEERING EXCELLENCE"

CIRCLE 121 or call 1-800-340-1160 x9121



Certificate Number FM 32340
BSI EN ISO 9001



THE QUEEN'S AWARD
FOR TECHNOLOGICAL
ACHIEVEMENT 1993



HOLROYD

DISTRIBUTORS
APPLY
FOR
DETAILS
REQUIRED

Intl. Headquarters: Harbour Lane North, Milnrow, Rochdale OL16 3LQ. England
Telephone: (44) 01706 526590 Telex: 635772 Holroyd G Fax: (44) 01706 353350

USA Office: RLH Associates, Inc., P.O. Box 807.3302 Hwy. 74 West Unit C, Monroe, NC 28111
Telephone: (704) 282-4895 Fax: (704) 289-9147

IMTS Traveling Companion

The gear lover's guide to "da show," plus native dishes, language lessons, amazing factoids and other bits about our kind of town.

Da Staff

CHICAGO'S an appropriate place for the largest machine tool show in North America. After all, the civic mantra here for nearly a hundred years has been to "make no small plans." But bigness has its downside. When you're in town for only a few days and have a lot of ground to cover, you have to zero in on the essentials.

That's where the intrepid Gear Technology staff comes in. We've spent months, weeks—well, half a day, anyway—picking out the good stuff. What follows is our exclusive gear lover's guide to McCormick Place and beyond.

IMTS SHOW BASICS

Where: McCormick Place, Chicago.

When: Sept. 4–11, 9 am until 6 pm daily (except Sunday, Sept. 8, from 10 am until 4 pm)

Who: 1,300 exhibitors occupying 1.1 million sq. ft. of exhibit space and an expected 100,000+ attenders.

Registration: (800) 322-IMTS.

MANUFACTURING '96

Sponsored by SME, *Manufacturing '96* is a conference on various manufacturing topics. Gear industry attenders won't want to miss the following clinics:

- Fundamentals of Gear Manufacturing, Sept. 9.
- Coordinate Measurement Systems Fundamentals, Sept. 4.
- Failure Analysis of Tool Steel Components, Sept. 4.
- Fundamentals of Coatings for Cutting Tools, Sept. 6.

Many other clinics and tutorials are available. For prices and registration information, call SME Customer Service Center, (800) 733-4763. Registration for *Manufacturing '96* includes admission to IMTS 96.

IMTS AMAZING NUMBER FACTOIDS

9 MILES OF CARPETING TO COVER THE AISLES.

32 football fields of exhibit space.

75 MILLION POUNDS OF EQUIPMENT AND MATERIALS ON LOCATION.

\$90 million

will be spent by IMTS visitors on meals, rooms, transportation and services.

436,000

hot dogs sold per year at McCormick Place.

ENGLISH—HOW SHE ARE SPOKE

This is a polyglot town. You can hear almost any language spoken on the planet (and a few from elsewhere) in *some* Chicago neighborhood. But we also have our own take on English. Here are a few important words and phrases to make you bilingual here.

- Please, the name is "Chi-caw-go." Saying "Chi-ca-go" or, worse, "She-ca-ga" is like stamping "out-of-towner" on your forehead.

- You may drink "soda" elsewhere, but here we drink "pop."

- Chicago kids don't wear "sneakers." They wear "gym shoes."

- Out-of-towners, the upscale folks in Lincoln Park and the intellectuals at the U. of C. all say, "he said." The rest of us Grabowskis say, "he goes."

- When a native talks to you about "a hunnert" of anything, he means "a hundred."

- "Da Mare" or "Hizzoner" is Richard M. Daley, the mayor. In other towns, mayors and their friends and associates have "pull." Here they have "clout." Clout may be the most important word in Chicago-ese, with the possible exception of "Michael Jordan."

DA EXHIBITS

Below is a list of gear-related booths you won't want to miss. *Gear Technology* advertisers are shown in bold.

Your first stop should be the Gear Generating Pavilion, a space in the North Building, Upper Level, devoted exclusively to gear generating equipment.

Gear Pavilion—North Building, Upper Level

B1-6967 American Pfauter/Pfauter-Maag Cutting Tools. Dry hobbing machines, form grinders, gear measuring machines, gear shaving machines, hobs, shaper cutters, form cutters, rack cutters, thin film coatings.

B1-6991 Vermont USA Machine Tool Group. Fellows Corp. (gear shapers), Bryant Grinder (grinding machines), J&L Metrology (optical inspection) and Jones & Lamson (lathes).

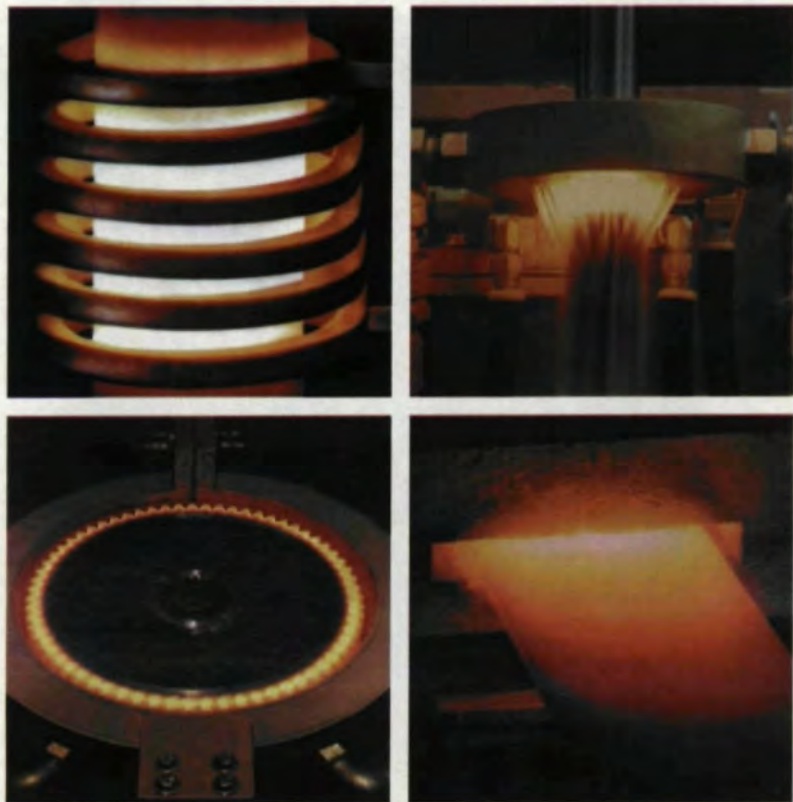

WORLD'S LARGEST SUPPLIER OF INDUCTION HEATING EQUIPMENT

RECOGNIZED WORLDWIDE, INDUCTOHEAT BLENDS COMPUTER CONTROL CAPABILITIES AND ENGINEERING KNOW-HOW TO INSURE YOU RECEIVE A STATE-OF-THE-ART HEATING SOLUTION.

THROUGH THEIR INTERNATIONAL ENGINEERING NETWORK AND IN-HOUSE TEST LABORATORIES, INDUCTOHEAT PROVIDES THE MOST ADVANCED INDUCTION TECHNOLOGY TO THEIR CUSTOMERS.

- ANNEALING
- CASE HARDENING
- CONTOUR HARDENING
- THROUGH HARDENING
- TEMPERING
- STRESS RELIEVING
- PAINT DRYING
- BRAZING
- BONDING
- SHRINK FITTING
- WIRE HEATING
- STRIP HEATING
- BAR HEATING
- BILLET HEATING

BEFORE YOU ORDER YOUR INDUCTION HEATING SYSTEM, TALK TO INDUCTOHEAT, THE WORLD LEADER IN INDUCTION HEATING TECHNOLOGY.

1-800-624-6297

WORLD HEADQUARTERS
MADISON HEIGHTS, MICHIGAN, USA
PHONE (810) 585-9393
FAX (810) 589-1062



 **IMTS 96**
CHICAGO — SEPTEMBER 4 - 11, 1996

BOOTH #B1-6477



INDUCTOHEAT

Via The INTERNET
<http://www.inductoheat.com>
or e-mail
info@inductoheat.com

IMTS SHOW COVERAGE

B1-7145 Mitts & Merrill L.P. Keyseating machines.

B1-7148 Reishauer Corp. Gear grinding machines, dressing attachments.

B1-7157 Koepfer America. Gear hobbing machinery.

B1-7158 Star Cutter Co. Tool & cutter grinders, hobs, shaper cutters, gun drills, pressure coolant reamers, milling cutters, thin film coatings, plated products, grinding wheels & dressers, carbide pre-form blanks.



The new 5-axis CNC universal tool and cutter grinder will be demonstrated by Star Cutter Co.

B1-7170 The Gleason Works. Dry hobbing machines, hypoid cutting machines, large bevel gear cutting machines, shaving machines, honing machines, helical gear grinders, tooling, workholding and a PC-based knowledge system.

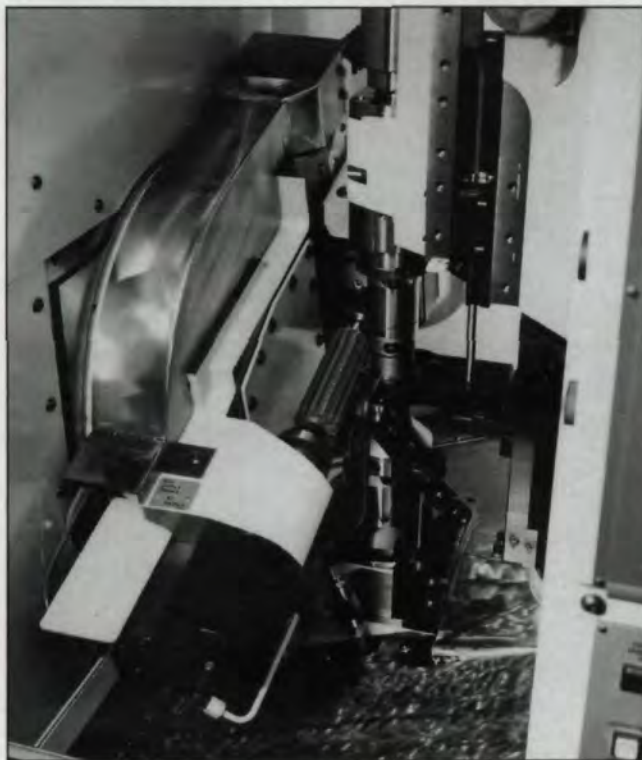

The Gleason Works will demonstrate dry hobbing and its new PC-based knowledge system on its PHOENIX 125GH hobbing machine.

B1-7176 Liebherr America/Sigma Pool. Dry hobbing machines, gear shaping machines, gear inspection & testing equipment.

ONE IN A SERIES

IMPROVE



GEAR PERFORMANCE

Nye Rheolube 377AL solves performance problems. Designed for a high-load, high-RPM planetary gear, it boosted gear set life from 20,000 to 50,000 cycles—a more than twofold increase. Suitable for temperatures as low as -40°C and fortified with special wear, oxidation and corrosion inhibitors, Nye Rheolube 377AL is just one of the many synthetic lubricants Nye designs for lubed-for-life gearing applications. From motors in household appliances, to power tool gear trains, to ABS systems and superchargers, get the performance edge with Nye. Call, fax, or write for data and samples.

Nye
LUBRICANTS

PO Box 8927
New Bedford, MA 02742-8927
Phone: 508-996-6721
Fax: 508-997-5285

Technical Insight

CIRCLE 147 or call 1-800-340-1160 x9147

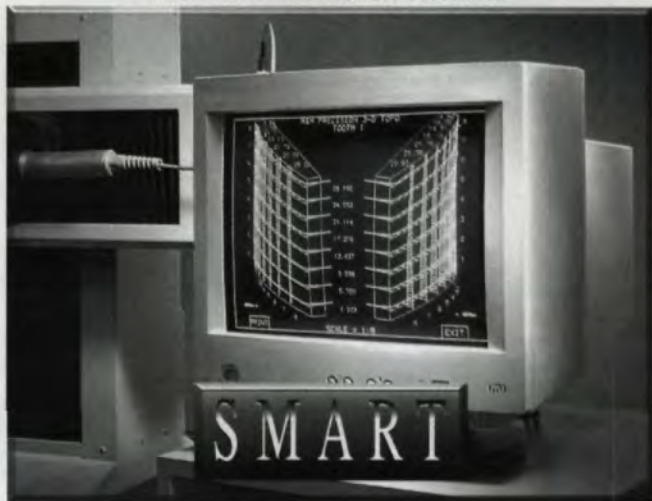

Powerful inspection packages from the industry's best selection of software • Pentium® technology • Exclusive GearNet® networking for multiple-machine installations and remote on-line analysis.

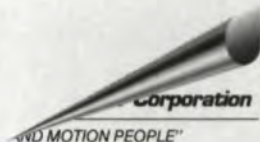

CIRCLE 140 or call 1-800-340-1160 x9140



The Unparalleled Resource for Innovative Gearing Technology

CNC Bevel Gear Production



Accuracy, consistency, durability, and quiet operation. Those are the hallmarks of gears produced with Oerlikon's advanced CNC cutting, lapping, and testing technology.

Whatever hypoid spiral bevel gear geometry you must produce - regardless of machine systems and methods - you can process it with versatile, reliable Oerlikon equipment.

For more information on our range of CNC spiral bevel cutting, lapping, and generating machines, contact Liebherr-America
1465 Woodland Drive • Saline, MI 48176
313 - 429 - 7225.

IMTS 96 BOOTH 7176

OERLIKON

IMTS SHOW COVERAGE

Other important exhibits of interest to gear lovers are found throughout McCormick Place.

North Building—Upper Level

B2-6306 Kokusai Inc. Honing machines.

B1-6477 Inductoheat, Inc. Induction heat treating systems.

B2-6535 Balzers Tool Coating, Inc. TiN, TiAlN, TiCN and other thin-film tool coatings.

B1-6935 JRM International. Deburring machines, grinding machines, honing machines, milling machines and part marking systems.

B2-7060 Schunk Inc. Chucks, arbors, clamping blocks, vacuum components, expansion units, grippers and accessories.

B1-7114 American Wera. Chamfering, gear generating, shaping and turning machines.

B1-7125 Edgetek Machine Corp. High efficiency deep grinding machines.

B2-7200 LMT-Fette, Inc. Solid carbide gash hobs, heavy duty roughing hobs and hobs with indexable carbide inserts.

B1-7335 Sunnen Products Co. Honing machines.

B1-7489 National Broach & Machine Co. Broaching machines, grinding machines, hobbing machines, honing machines, inspection equipment, shaping machines, shaving machines, spline rolling machines and cutting tools.

North Building—Lower Level

C1-5007 Charmilles Technologies Corporation. EDM machines & tooling.

C1-5407 Agie USA Ltd. EDM machines and tooling.

East Building—Upper Level

D2-4254 Mitsubishi Machine Tool. Hobbing machines, hobbing/finish rolling machines, gear shaving machines, high speed drilling machines.

D2-4358 WMW Machinery Company. TOS Celakovice Gear Hobbing machines, Mikromat worm and thread grinders and other machine tools.



The TOS Celakovice OFA 32 R hobbing machine will be shown by WMW Machinery Company.

D2-4359 Carl Zeiss, Inc., Industrial Measuring Technology Division. High precision inspection and measurement equipment.



LeCOUNT

EXPANDING MANDRELS



LeCOUNT, Inc.
 12 Dewitt Dr., PO Box 950
 White River Jct., VT Tel. (800) 642-6713 Fax. (802) 296-6843

CIRCLE 112 or call 1-800-340-1160 x9112

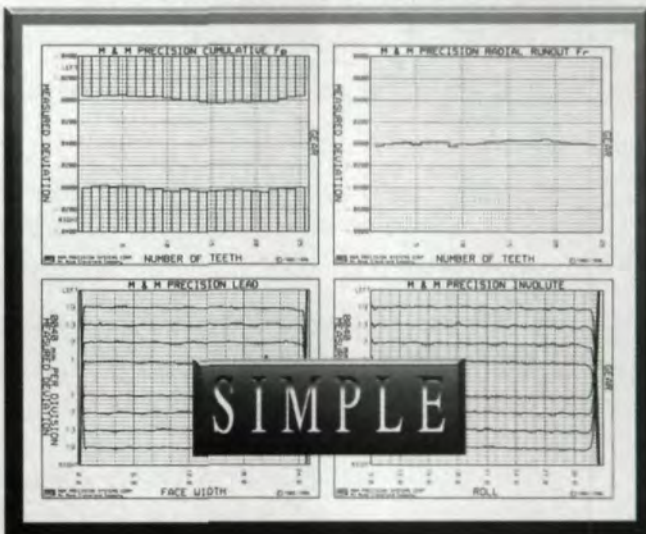

So easy to use — and it's an industry standard

- No part programming required
- Single page reporting gives you all the facts at a glance with four charts on one sheet.

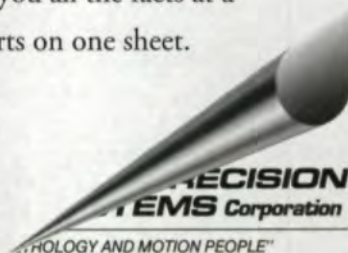

CIRCLE 140 or call 1-800-340-1160 x9140

Shave The Time On Shave Cutter Delivery

National Broach Now Has ESP!



With the latest in CNC equipment and manufacturing processes, all of which are controlled in-house, along with full CNC inspection capability, your shave cutter demands can be met with the National Broach **ESP** (Express Service Processing). **ESP** deliveries on new Shave Cutters are shipped within *4 weeks* or you can use our standard quick *6-8 week* delivery service. Standard turnaround on reconditioned Shave Cutters are only *7-10 days*. **ESP** service is also available on reconditioned tools.

Along with the fastest deliveries available, National Broach stands ready to meet your needs with experience, application assistance, engineering, training, full customer support and cost effective tools.

To fulfill your needs... *call the company with the best delivery!...* contact our Shave Cutter Department for immediate assistance.

CIRCLE 114 or call 1-800-340-1160 x9114



National Broach & Machine Co.

The Leader In Gear Shaving Technology

17500 Twenty-Three Mile Road Macomb, Michigan 48044

Phone: 810-263-0100 Fax: 810-263-4571

IMTS SHOW COVERAGE

D1-4385 Ikegai America Corporation. Gear hobbing machines and hob sharpening machines.



Ikegai America will introduce the SX-15 high-speed gear hobber.

D1-4619 Brown & Sharpe Mfg. Co., Custom Metrology Division. High precision inspection and measurement equipment.

D1-4633 Giddings & Lewis, Sheffield Measurement Div. High precision inspection and measurement equipment.

D1-4700 Deckel-Maho-Gildemeister America. Universal machining centers, lathes, turning centers.

East Building—Middle Level

E1-2429 CIMNET/JNL Industries. Shop management & SPC software.

E1-2561 Indramat Division, Rexroth Corporation. Motion control systems.

FLOW CHART OF APPLICATION

System Performance

Feed Constant	10.541 inch	Gearing Ratio	3.70 to 1
Max. Minimat Speed	2500.0 RPM	Max. Motor Speed	2845 RPM
Total Deflected Inertia	3.7039 lb-in ²	Inertia Mismatch	24.66 to 1
S-Curve Acceleration	30.00 %	S-Curve Deceleration	30.00 %
Acceleration Time	25.000 s	Deceleration Time	12.500 s
Acceleration Rate	23.5 a/s ²	Deceleration Rate	47.1 a/s ²
Acceleration Torque	60.1 Nm	Deceleration Torque	-130.3 Nm
Accel Torque Margin	69.0 %	Decel Torque Margin	77.9 %
Base Torque	0.0 Nm	Base Torque Margin	100.0 %
Required Peak Power	2.0 kW	Required Avg. Power	0.0 kW
Peak Regen Energy	19385.4 W-s	Avg. Regen Power	0.0 W

Indramat AC Servo

Motor With Blower	MD0120-N-010	Rated Speed	3300 rpm
Amplifier	DC0302-1-W000	Motor Inertia	0.1925 lb-in ²
Power Supply	TVD	Peak Torque	545.2 Nm
Overload Factor	200 %	Continuous Torque	339.4 Nm

Indramat introduces a Windows-based program for analyzing machine requirements and selecting motion control components for best performance.

E1-2640 Ingersoll Cutting Tool Company. Milling cutters and other cutting tools.

SPIRAL BEVEL GEARS



Spiral & Straight Bevel Gear Manufacturing. Commercial to aircraft quality gearing. Spur, helical, splined shafts, internal & external, shaved & ground gears. Spiral bevel grinding.

Mil-I-45208 • Mil-STD-45662, SPC

MIDWEST GEAR & TOOL, INC.
26069 Groesbeck Hwy.
Warren, MI 48089



CONTACT:
CRAIG D. ROSS
(810) 776-7580
FAX (810) 776-2322

CIRCLE 113 or call 1-800-340-1160 x9113



- Accuracy traceable to NIST • Repeatability (six sigma) to sub-micron levels • True generative index, lead and involute testing
- Bevel gear process control packages
- Precise four-axis flexibility.

M&M PRECISION SYSTEMS Corporation

"THE METROLOGY AND MOTION PEOPLE"

CIRCLE 140 or call 1-800-340-1160 x9140



**GEAR
MACHINES**

BRAND NEW GEAR MACHINES

- very attractive prices
- immediate delivery available
- 18 different models of shapers, hobbers, shavers, honers, grinders, hob sharpeners, and inspection equipment

You can afford a new Wolf gear machine.

**Model GH8-6FP
Fine Pitch
Gear Hobber
\$46,995**

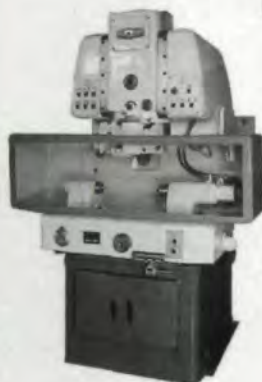
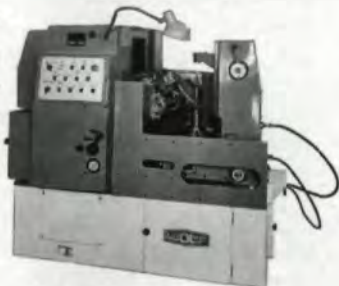

**Model GHM 12.5-3.5
Gear Honing Machine
\$27,995
(Reduced)**

**Model 12 SLOT
Keyway & Spline Slotter
\$9,995
(Reduced)**



over 35 years experience in gears and gear equipment

...always ahead of the pack!

NATIONAL DISTRIBUTOR:

**B
I
G**
INCORPORATED
GROUP

Telephone: (213) 933-0311
Fax: (213) 933-7487
P.O. Box 36276, Los Angeles, CA 90036

EASTERN REPRESENTATIVE:

SPECK GEAR SERVICES, INC.

Phone: (630) 213-8340 • Fax (630) 213-8341
P.O. Box 88177, Carol Stream, IL 60188-0177

CIRCLE 111 or call 1-800-340-1160 x9111

IMTS SHOW COVERAGE



LOUIE "DA LIZZARD'S" GUIDE TO FINE DINING

Chicago's been about doing business since Jean Baptiste DuSable dealt in beaver pelts from his outpost at the mouth of the Chicago River. It's been about feeding the visitors since he diversified by adding a smokehouse and a vegetable garden to his holdings. Now Chicago has nearly 10,000 restaurants, and if you can't find something you like to eat, it's because you're not trying very hard.

As part of our mission to cut to the IMTS chase, we've sent our resident insider, gourmand, barfly and expert on all things Chicago, Louie "Da Lizzard," to report on the best places to eat, so you can devote your attention to the important things, like buying and selling gear equipment.

Like everything else about Louie, his list is unique. Most of the places here are not "hot." With few exceptions, you won't see movie stars or even aldermen with diamond pinky rings. These restaurants are about food, not glitz. The only criterion for inclusion is that the eatery has appeared on Louie's gastronomic radar in a positive light. So after you've fulfilled your promises to bring home T-shirts and menus from places belonging to sports mega-legends, check out the following: They're among the spots where the natives eat.

The Berghoff. 17 W. Adams. 312-427-3170. In the heart of The Loop, The Berghoff has been feeding the burghers of the city since shortly after the 1871 fire, and the ambience reflects a bustling Old Chicago of an earlier time. Reasonably priced, the food can best be described as Midwest/German. Louie's informant swears by the sauerbraten, the flourless chocolate cake and the private label dark beer. Warning: It's tempting to begin by scarfing down all the complimentary rye bread on your table with a mug of that beer. Careful or you won't have room for your entrée.

The Parthenon. 314 S. Halsted. 312-226-3377. West of The Loop in Greektown, a fairly short cab ride from McCormick Place. Lively atmosphere. Ohpa! and all that. Great lamb dishes. Louie says the *spanakopita* (spinach pie) is also fairly wonderful. One of his cronies always orders *skordalia* (a veggie and bread dip made of mashed potatoes, garlic and olive oil—trust Louie, this tastes much better than it sounds) and the octopus salad. Good value for your money.

Morton's—The Steakhouse. 1050 N. State (Newberry Plaza). 312-226-4820. This is for serious meat-and-potatoes people. For the most serious of them, there's a 48-oz. double porterhouse. Also live lobster, daily fresh fish choices and

salads to keep up with the steak sizes. Pricey and a bit elegant. You might want to take your important clients here. Serves dinner only and reservations are a good idea. Louie says this is definitely a coat-and-tie spot.

The 95th. 875 N. Michigan (Top of the John Hancock Center). 312-787-9596. This is the other place you might want to take the people you most need to impress. Good food elegantly served and an unmatched view of the city, especially at night. Another spot where reservations, a coat, tie and expense account are in order.

Rosebud Cafe. 1500 W. Taylor (312-942-1117) or 55 E. Superior (312-266-6444). The W. Taylor site is the original restaurant in the heart of what was an old Italian neighborhood and now is near-neighbor to the University of Illinois at Chicago. It's closer to McCormick Place than its newer incarnation just off glitzy N. Michigan Ave. Italian food for grownups. Good meat and fish entrees, excellent pasta dishes, fresh hot breads and an impressive wine list. Another case of giant portions: Louie says bring a large appetite or prepare to take away a doggie bag. Rosebud was indeed THE eatery in town not too many years ago, and is still very popular, especially on weekends. Better make reservations.

Reza's. 5255 N. Clark (312-561-1898) or 432 W. Ontario (312-664-4500). Serves Persian food, which is Greek food with a foreign accent. Several types of meat kebabs are good safe choices, but if you're feeling adventurous, the cornish hen smothered in pomegranate-walnut sauce is very good. Some vegetarian items. A bit boisterous, but both rooms welcome large parties. Inexpensive by Chicago standards. The original Reza's on Clark is a bit of a cab ride from McCormick Place and most hotels, but it's in a marvelous, funky, multi-ethnic neighborhood, and many people prefer the atmosphere there. Louie's girlfriend reminds the women in your party: Reza's waiters were listed among the 25 sexiest Chicagoans in a recent issue of a local magazine (and this is without removing their bow ties and black jackets).

La Novita. 1232 W. Belmont. 312-404-8888. More Italian food for people who've gone beyond pizza and pasta with red sauce (although there is very good pizza on the menu). Not as crowded or upscale as Rosebud, it has the look and feel of a friendly neighborhood hang-out. Louie and his friends like the outdoor patio on warm evenings and the free parking behind the building. Owner/chef Giovanni Camaci takes his cooking seriously, and his careful attention shows up on your plate, the wine list and the well-stocked bar.

The Emperor's Choice. 2238 S. Wentworth. 312-225-8800. In the heart of Chinatown, this is only a short cab ride from McCormick Place. It specializes in Cantonese food. Seafood choices are a specialty. The menu here is extensive and elaborate, and Louie suggests the uninitiated might want to ask the waiters for advice. Serves both lunch and dinner and offers a good value for the dollar. ◊

Tell Us What You Think...

If you found this article of interest and/or useful, please circle 205.

SERVICE/QUALITY!

MASTER GEARS

SPUR AND HELICAL

We've been supplying the gear industry for over 30 years with reliable **SERVICE** and **QUALITY** all our master gears being to spec.

We are also expert at refurbishing worn or damaged master gears (for example, the automotive industry). Every gear we deliver is precision ground and backed by a Parker test certificate.

Call to discuss your requirements with us.



PARKER INDUSTRIES INC.

1650 Sycamore Ave., Bohemia, NY 11716
1-516-567-1000 • Fax: 1-516-567-1355

CIRCLE 168 or call 1-800-340-1160 x9168



Guaranteed best, with the only three year warranty in the business. Get all the facts. Phone 513/859-8273 or fax 513/859-4452.

M&M PRECISION SYSTEMS Corporation

"THE METROLOGY AND MOTION PEOPLE"

CIRCLE 140 or call 1-800-340-1160 x9140

Tooth Modification and Spur Gear Tooth Strain

Fred B. Oswald & Dennis P. Townsend

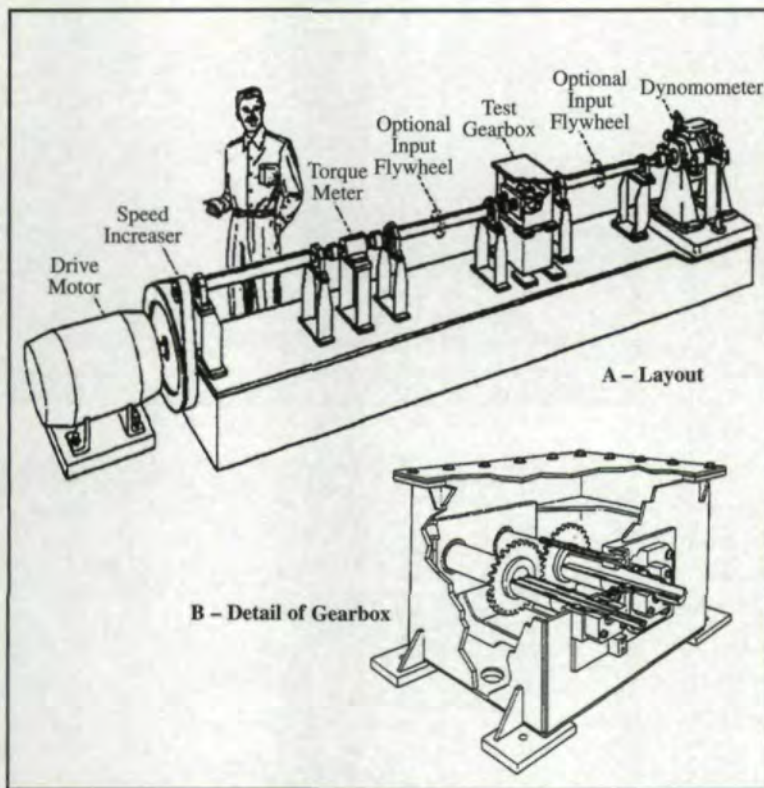

Fig. 1 — NASA gear noise rig.



Fig. 2 — Strain gage installation on test gear.

A major source of helicopter cabin noise (which has been measured at over 100 decibels sound pressure level) is the gearbox. Reduction of this noise is a NASA and U.S. Army goal.

Noise excitation in a transmission is caused by the load fluctuation as gear teeth enter and leave mesh. The cyclic variation in the numbers of teeth carrying the load causes a periodic change in the tooth stiffness and affects the relative position of the teeth. Any deviation in the angular position of the driven gear from its ideal position is called the transmission error. Transmission error arises from manufacturing and mounting errors and from tooth deflection under load.

High-quality gear designs often include modified tooth profiles (tip relief) to minimize transmission error. *Dudley's Gear Handbook* (Ref. 9) provides formulas for "first approximations" of tip relief based on the load and face width. Previous studies of spur gear profile modification include Refs. 2, 4, 5 and 8. Dynamic strain gage testing was reported in Refs. 6 and 7.

The goal for the research reported in this article was to examine the influence of tooth profile modification on dynamic tooth strain by means of controlled tests and to provide a database for further research. Data presented here include involute (tooth profile) charts for the test gears and time domain plots of static and dynamic gear tooth bending strain.

Apparatus

Tests were performed on the NASA gear noise rig (Fig. 1). The rig features a single-mesh gearbox powered by a 150 kW (200 hp) variable speed electric motor. An eddy-current dynamometer loads the output shaft. The gearbox can operate at speeds up to 6,000 rpm. The rig was built to carry out fundamental studies of gear noise and the dynamic behavior of gear systems. It is designed to allow testing of various configurations of gears,

bearings, dampers and supports. The gearbox is extensively instrumented for strain, noise and vibration measurements.

A poly-V belt drive was used as a speed increaser between the motor and input shaft. A soft coupling on the input shaft reduces the input torque fluctuations caused by non-uniformity of the belt splice.

The gearbox oil inlet temperature was maintained at $70 \pm 2^\circ\text{C}$ for these tests. At the mean temperature of 70° , the viscosity of the synthetic turbine engine oil (MIL-L-23699B) used in the tests is 9.5 centistoke.

Instrumentation. General-purpose, constantan foil, resistance strain gages with gage length 0.38 mm (0.015") were installed in the tooth-root fillets on both the loaded (tensile) and unloaded (compression) side of two adjacent teeth on the output (driven) gear (Fig. 2). To measure maximum tooth bending stress, the gages were placed at the 30° tangency location (Ref. 1). Two methods of signal conditioning were used on strain gage signals: For static measurement, a strain gage (Wheatstone) bridge was used. For dynamic measurements, the strain gages were connected via a slip-ring assembly to constant-current strain gage amplifiers.

An 8-channel, 12-bit digital data acquisition system was used to record the dynamic strain data. The sample rate was varied from 6.6–50 kHz per channel to provide 500 samples per revolution for each channel. An optical encoder on the input gear shaft produced an accurate once-per-revolution pulse. The encoder was adjusted so the leading edge of its pulse occurred at a known roll angle of the gear. This allowed us to determine the roll angle at any point in the data record.

Test Gears. The test gears were identical spur gears (at 1:1 ratio) machined to master gear (AGMA Class 15) accuracy. Test gear parameters are shown in Table 1. Profile modifications were chosen to compensate for tooth deflection under load. No additional allowance was made for manufacturing errors, since these errors were not more than one-tenth of the computed deflection at the nominal load of 71.8 N-m (635 lb-in).

Six different gear profiles (Fig. 3) were tested. These include an unmodified profile, three combinations of linear profile modification (tip relief) and two different forms of parabolic modification. Linear modification is defined by two parameters: The amount of modification at the tip and the roll angle at the start of modification. For parabolic modification, a third parameter is needed. We identified two forms of this third parameter: In type-1 parabolic relief (see Fig. 3e), the modified

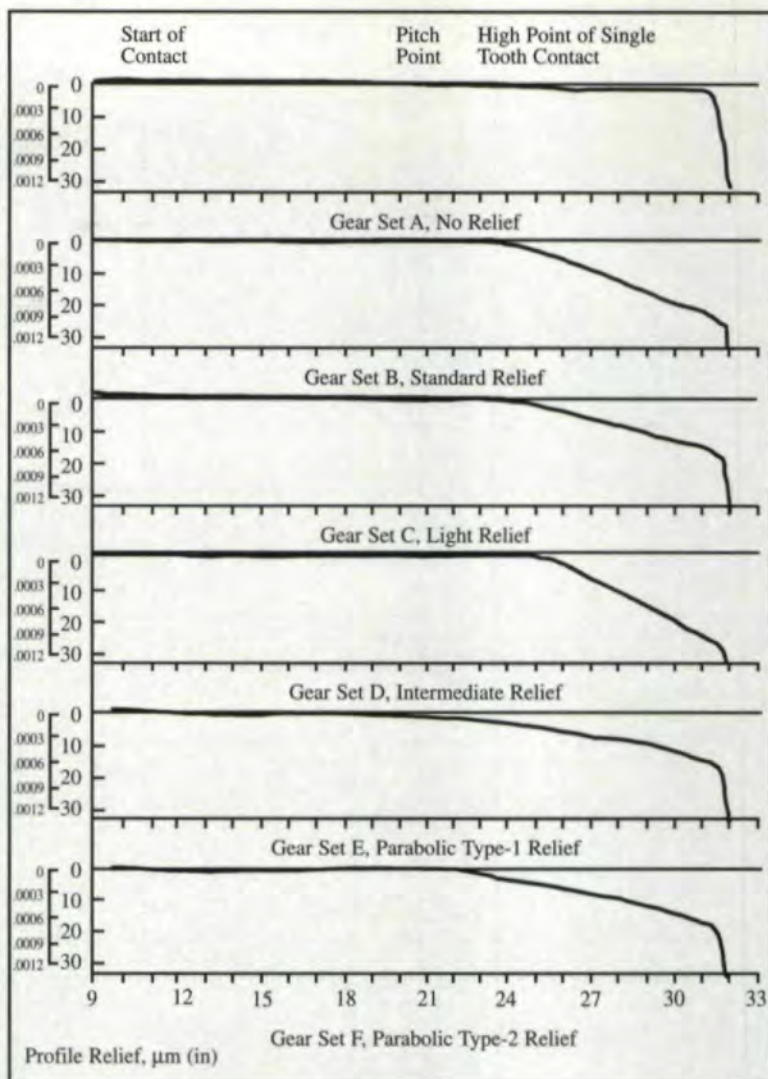

Fig. 3 — Profile charts for the six sets of test gears.

Table 1 — Test Gear Parameters

Gear Type	Standard, Full-Depth Tooth
No. Teeth	28
Module, mm (Diametral Pitch, in ⁻¹)	3.175 (8)
Face Width, mm (in)	6.35 (0.25)
Pressure Angle, deg	20
Theoretical Contact Ratio	1.64
Tooth Root Radius, mm (in)	1.35 (0.053)
Max. Tooth Spacing Error, μm (in)	1.8 (0.00007)
Max. Profile Error, μm (in)	1.3 (0.00005)

profile blends smoothly into the involute trace. (It is tangent to the involute at the start of modification.) In type-2 parabolic relief (see Fig. 3f), the modified portion of the curve blends into the edge break at the end of the tooth. (It has an infinite slope at the tip.) These gears were made to the AGMA Class 15 quality level. Even so, there is not much apparent difference between the traces for set E (type-1) and set F (type-2) gears.

Fred B. Oswald

is a research engineer at NASA Lewis Research Center, Cleveland, OH. He is the author of numerous papers on gearing subjects.

Dennis P. Townsend

is a senior research engineer at NASA Lewis Research Center. He is the author of numerous books and papers on gear-related subjects and is the editor of Dudley's Gear Handbook, 2nd ed.

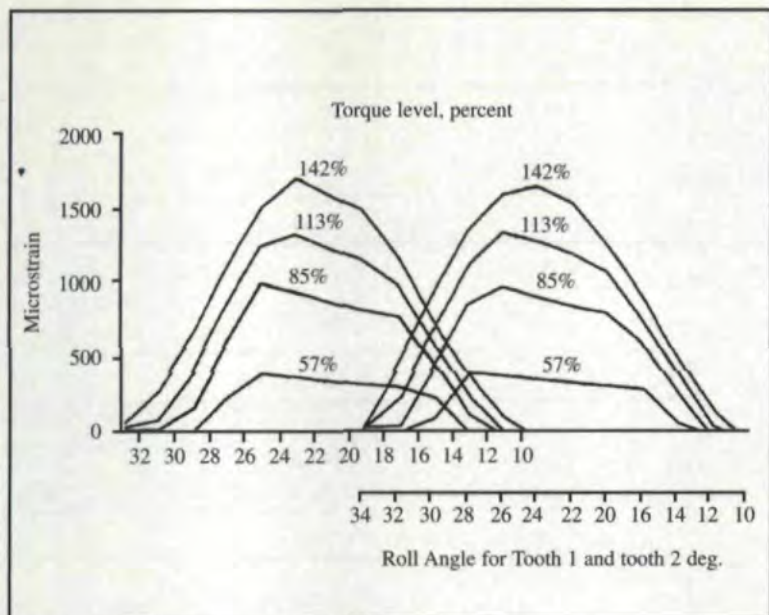

Fig. 4 — Static strain traces for Gear Set B.

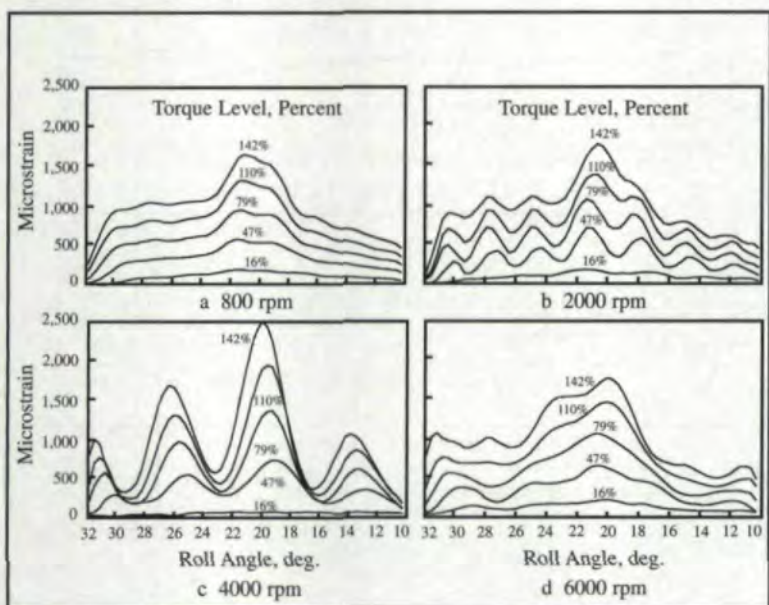

Fig. 5 — Gear Set A, no relief.

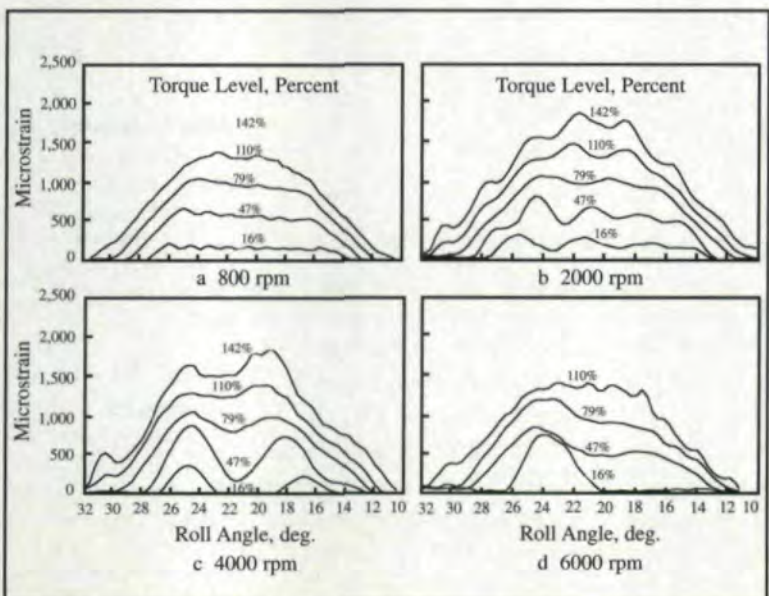

Fig. 6 — Gear Set B, standard relief.

Test Procedure

Static Strain Data. Strain data was recorded under static (non-rotating) conditions. Static measurements provide information on load sharing characteristics of the gear pairs. Strains were recorded for roll angles from 32° to 10° roll angle for each tooth. (Note: the strain gages are on the driven gear, hence contact starts near the tip and proceeds towards lower roll angles at the root of the tooth.) Readings were taken at torque levels of 57%, 85%, 113% and 142% of the nominal torque of 71.8 N-m (635 lb-in).

Dynamic Strain Data. Dynamic strains were recorded for each of the six gear pairs over a matrix of load-speed test conditions: 4 speeds (800, 2,000, 4,000, 6,000 rpm) and torque levels of 16%, 47%, 79%, 110% and 142% of the nominal torque of 71.8 N-m (635 lb-in). The data were then digitally resampled using linear interpolation at 1,000 samples per revolution and synchronously averaged. Time domain synchronous averaging is a technique now in wide use in gear diagnostics (see Ref. 3), and was used here to reduce random "noise" effects (such as torque fluctuation caused by the belt drive). Its implementation requires at least two channels of data—a timing signal plus the data of interest. The timing signal provided the resample intervals needed for exactly one revolution of the gear.

Results and Discussion

Static strain data was collected primarily for use in an effort to compute normal and frictional loads between gear teeth (see Ref. 7). Fig. 4 shows static strain data from two consecutive teeth on gear set B (standard "long relief" profiles) taken at four different torque levels. Static strain readings were recorded at two-degree increments, except an extra reading was taken at 21° , which is near the pitch point (20.85°). Comparing readings from the strain gages mounted on adjacent teeth provides an indication of the accuracy and consistency of the strain gage installations. For all the gears tested, the maximum difference (worst case) in measured static strain between the two tensile gages was 4.6%.

The dynamic strain data for the six test gear designs is shown in Figs. 5–10. These figures show strains measured by one of the load-side gages as sets of parametric curves, each set for a single gear design, at a single speed, but at several torque levels.

Set A—Unmodified Gears. The gears designated Set A have essentially a true involute profile (see Fig. 3) up to the edge break at about 31° roll angle. Ref. 4 shows that the transmission error of a perfect involute gear is zero at no load (torque), but

increases with the load. Therefore, we would expect these gears to show increasing dynamic action as torque increases. This is indeed the case. Low-speed measurements (Fig. 5a) show very smooth operation with little dynamic excitation. Tooth contact extends from about 32° to 10° . Two pairs of teeth are in contact except in the single contact zone, which extends from about 22° to 18° .

As the speed increased to 2,000 rpm (Fig. 5b), dynamic effects become apparent, especially at the higher torques. A regular pattern of waves can be seen in the strain curves. At 1,000 rpm, one tooth pitch period occupies about 13° of roll angle (360° divided by 28 teeth). In this span there are about four cycles of strain. This indicates that the dynamic loading frequency is four times the tooth mesh frequency. At 4,000 rpm (Fig. 5c), the dynamic action is much stronger, and there are two strain cycles per tooth pitch. At 6,000 rpm, the dynamic effects are not as strong and there is no regular wave pattern.

Set B—Standard Relief. The strain data from Set B gears is shown in Fig. 6. Because of dynamometer control problems at the time these data were taken, the highest torque (142%) curve is missing in Figs. 6a and 6d.

Set B gears have linear profile modification (Fig. 3) extending from the high point of single tooth contact to the tip. Munro calls this "long relief." (In contrast, "short" relief has a modification zone one-half as long.) The amount of relief at the tooth tip corresponds to the tooth deflection expected from a torque level of 115% of the nominal 71.8 N-m.

The low speed traces (Fig. 6a) show that the single contact zone is longer than in the Set A gears. The profile modification has apparently decreased the contact ratio. At higher speeds (Figs. 6b to 6d), there was smooth operation near the design torque, but much rougher operation away from design torque, especially at high-speed, low-torque conditions. At 4,000 rpm and 16% torque, there are two strain "spikes" at the beginning and end of tooth contact, and the strain is zero at the pitch point. This indicates that the teeth bounce out of contact. At 6,000 rpm and 16% torque, there is a single large strain spike. This indicates relatively high dynamic loading.

Set C—Light Relief. The gears from Set C are similar to Set B except the amount of relief is much less, corresponding to the deflection for 70% torque. As would be expected, these gears operate more smoothly at light torque, but with increased dynamics at higher torques.

Set D—Intermediate Relief. Set D gears have a shorter relief zone than Sets B or C. Munro in

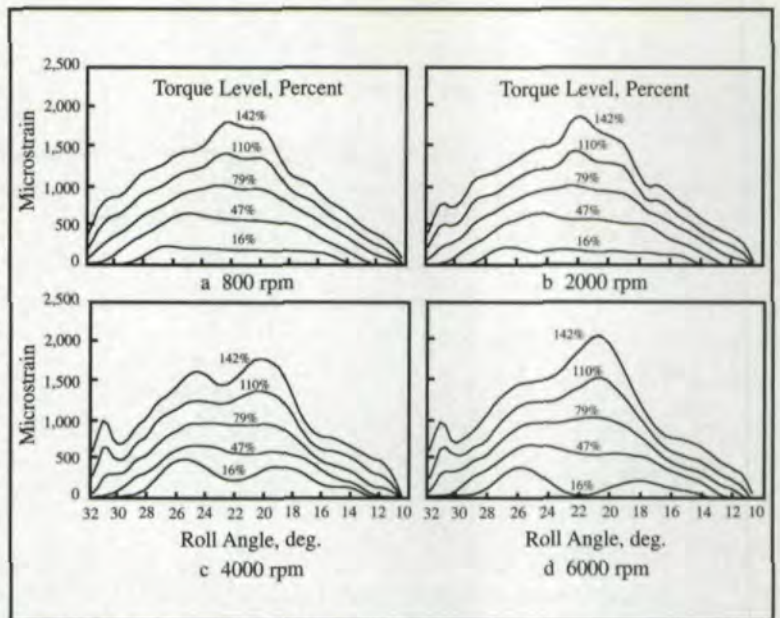

Fig. 7 — Gear Set C, light relief.

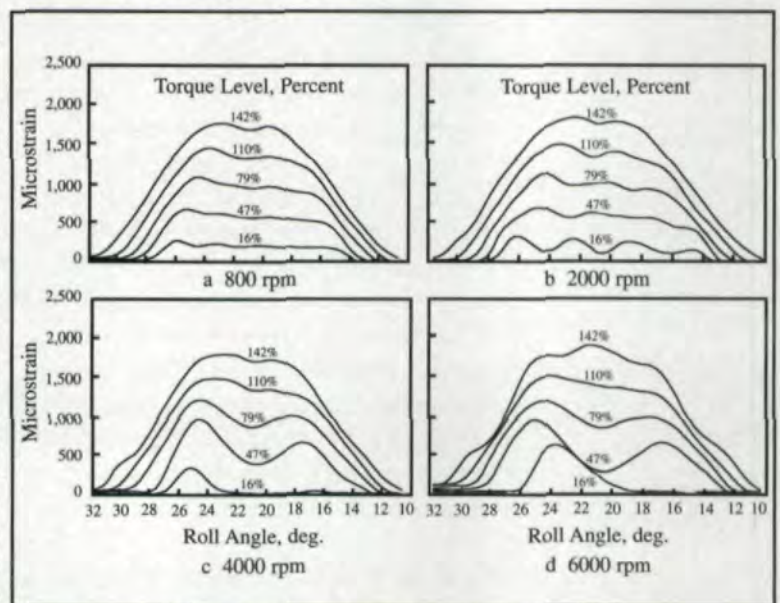

Fig. 8 — Gear Set D, intermediate relief.

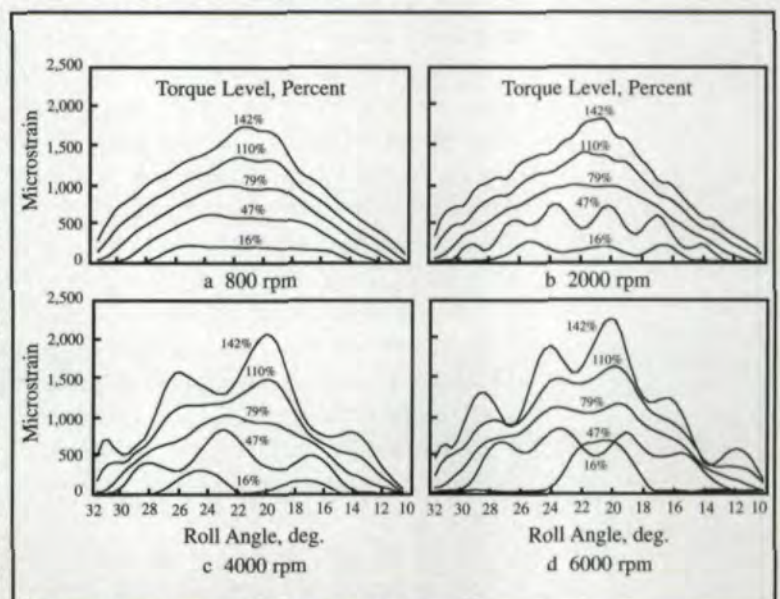

Fig. 9 — Gear Set E, parabolic type-1 relief.

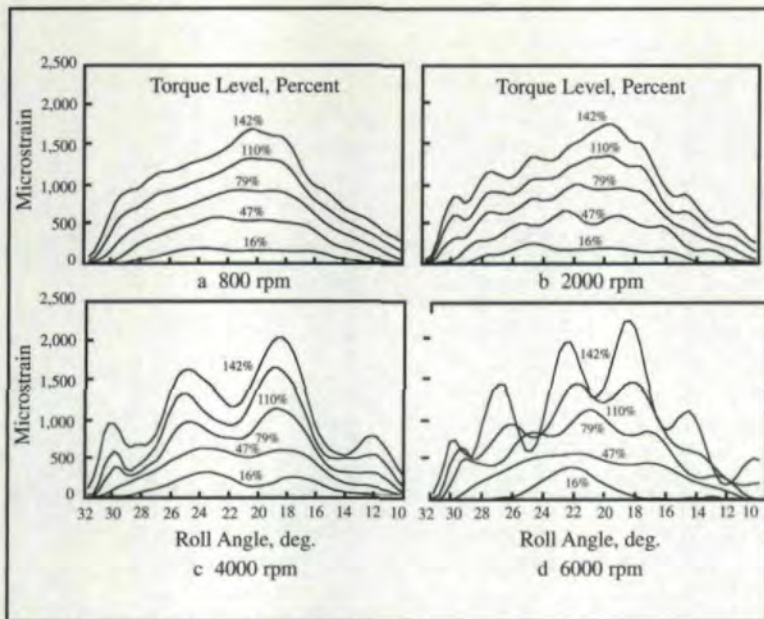

Fig. 10 — Gear Set F, parabolic type-2 relief.

Ref. 4 calls this "intermediate relief" and recommends it for gears which operate under a range of loads. The amount of relief at the tooth tip corresponds to 135% torque. The results (Fig. 8) show very smooth operation at high torque, and light torque operation is comparable to Set B. Since they show improvement at high torque and no worse operation at low torque (compared to Set B), intermediate relief is an improvement over long relief.

Set E—Parabolic Type-1. These gears are similar to Set C gears except the modification zone extends to the pitch point. (Munro calls this "extra long relief.") The modification at the tip corresponds to torque of 65%. These gears were difficult and expensive to manufacture. Their performance was disappointing. The dynamic strains were large at both high and low torques. Results may have been better if the relief zone were much shorter.

Set F—Parabolic Type-2. These gears are similar to Set E except the modification amount at the tip corresponds to the tooth deflection at 85% torque, and the modification zone is slightly shorter. Like Set E, these are difficult and expensive to manufacture. The performance was similar to that of Set E.

Summary and Conclusions

Low contact ratio spur gears with various profile modifications were tested in the NASA gear noise rig. Dynamic tooth bending strains were recorded for each gear design at 36 operating conditions. The experimental results were compared to examine the influence of the tooth profile on the dynamic behavior of the gears under various operating conditions. The following conclusions were drawn from the data:

1. The proper type and amount of tooth profile modification can significantly reduce dynamic loads in spur gears, especially for gears that operate at high speed and under high torque.

2. The parabolic modification gears tested here seem not to offer any advantage. This may be because the modification zone is too long.

3. Profile modification increases dynamic loads in gears that operate significantly below their design torque. This is especially so for a long modification zone. ⚙

References:

1. Cornell, R. W. "Compliance and Stress Sensitivity of Spur Gear Teeth." ASME Paper 80-C2/DET-24, 1980.
2. Lin, H. H. et al. "Dynamic Loading of Spur Gears With Linear or Parabolic Tooth Profile Modifications." *Proceedings, ASME 1992 Int'l Power Transmission & Gearing Conference, Chicago, Sept., 1989.* (Also NASA-TM-101444.)
3. McFadden, P. D. "Examination of a Technique for the Early Detection of Failure in Gears by Signal Processing of the Time Domain Average of the Meshing Vibration." *Mechanical Systems and Signal Processing*, Vol. 1, No. 2, 1987, pp. 173-183.
4. Munro, R. G. et al. "Optimum Profile Relief and Transmission Error in Spur Gears." *Proceedings of the Institution of Mechanical Engineers, First International Conference on Gearbox Noise and Vibration, University of Cambridge, England, 1990.*
5. Munro, R. G. "The D. C. Component of Gear Transmission Error." *Proceedings, ASME, 1989 Int'l Power Transmission & Gearing Conference, Chicago, April, 1989.*
6. Oswald, Fred B. et al. "Comparison of Analysis and Experiment for Dynamics of Low Contact Ratio Spur Gears." NASA TM 103232, AVSCOM TR-90-C-017.
7. Rebbeci, B. et al. "Dynamic Measurements of Gear Tooth Friction and Load." AGMA Report 91-FTM-10. (Also NASA TM-103281.)
8. Tavakoli, M. S. & D. P. Houser. "Optimum Profile Modifications for the Minimization of Static Transmission Errors of Spur Gears." *Journal of Mechanisms, Transmissions, and Automation in Design*, Vol. 108, No. 1, pp. 86-95. (ASME paper 84-DET-173.)
9. Townsend, Dennis P., ed. *Dudley's Gear Handbook*, McGraw-Hill, Inc., 1991.

Tell Us What You Think...

If you found this article of interest and/or useful, please circle 206.

For more information about NASA Lewis Research Center, please circle 207.

Need to contact an advertiser NOW? No time to fool around with bingo cards?

Use the *Gear Technology* Rapid Response Hot Line.

Here's how it works:

Note the 4-digit PIN number assigned to the display ad you're interested in.



 Call 1-800-340-1160. At the prompt, dial in the PIN number and — Ta Da! — you'll be immediately connected directly to the advertiser!

 Talk to real live people. Ask questions. Request literature. Explain your special needs. Get the information you need right away — all with one simple toll-free phone call.

There's no faster way to get the answers you need about products and services you see advertised in *Gear Technology*.

ADVERTISER INDEX

For more information about a product or service advertised in this issue of *Gear Technology*, circle the appropriate number on the Reader Response Card and put the card in the mail.

Advertiser	Reader Service Number	Page Number	Advertiser	Reader Service Number	Page Number
A/W Systems Co.	105	53	M&M Precision Systems	140	13,15,17,19
AGMA	125	40	M&M Precision Systems, Master Gears/Spline Gages Div.	163	43
Amarillo Gear	151	46	Manufactured Gear & Gage	164	32
American Metal Treating Co.	174	55	Merit Gear Corp.	177	55
American Pfauter, L.P.	101	IFC	Midwest Gear & Tool Inc.	113	17
American Sykes Co.	109	44	Mitsubishi Machine Tools	107,185-187	6,42
Ataka Machinery Co., Ltd.	148	50	Modified Gear & Spline	178	54
Barit International Corp.	175	55	Moore Products Co.	106	5
Basic Incorporated Group	111	18	National Broach	114	16
Clarke Gear Co.	194	55	Niagara Gear	135	8
Comtorgage	156	4	Nye Lubricants	147	13
Detroit Broach	193	42	Parker Industries	168	19
D.I.G.I.T.	157	40	PC Enterprises	184	54
Educational Systems Workshops	149	43	Perry Technology Corp.	146	4
Equitable Engineering	190	55	Pfauter-Maag Cutting Tools, L.P.	102,179	1,54
Ernst Winter & Son	137	42	Pro-Gear Co. Inc.	180	54
Forest City Gear	138	IBC	Profile Engineering	133	52
Gleason Works	100	BC	Roto-Technology	118,182	50,54
Holroyd	121	10	Schunk Inc.	177,188	42
Ikegai America Corp.	124	47	Starcut Sales Inc.	128,132,150	2,9,41
Inductoheat	131	12	Sunnen Products Co.	173	42
LeCount Inc.	112,176	15,54	WMW Machinery Company	127	33
Liebherr	162	14			

Alternative Lubrication Methods for Large Open Gear Drives

Dennis A. Lauer, P.E.

The type of lubricant and the method of applying it to the tooth flanks of large open gears is very important from the point of view of lubrication technology and maintenance. When selecting the type of lubricant and the application method, it is important to check whether it is possible to feed the required lubricant quantity to the load-carrying tooth flanks. This is necessary to avoid deficient lubrication, damage to the gear and operational malfunctions. It is important to determine the type of lubricant, which may be fluid or grease-like. The consistency of the lubricant will have a direct impact on the ability of the lubrication system to feed adequately the lubricant to the gear. The interactions between the common types of lubricant and the lubrication application methods for open gear drives are shown in Fig. 1.

Basically, there are two types of lubrication for open gear drives: Continuous lubrication (long term lubrication) and intermittent lubrication (total loss lubrication). With both these types of lubrication, several application methods are possible.

Continuous Lubrication

Continuous lubrication means that the lubricant is fed to the friction point (the tooth meshing zone) without interruption. The lubricant volume at the load-carrying tooth flanks can vary between an extremely high and a minimal amount. Continuous lubrication may be provided by immersion lubrication, transfer lubrication with a paddle wheel or circulation lubrication.

Immersion Lubrication

Generally, immersion lubrication is one of the safest methods of applying a lubricant to an open gear drive. To function properly the lubricant bath must remain adequately filled and the gear guard cover properly sealed to avoid lubricant losses. Modern fluids, which were especially developed for open gear drives and whose consistency and flow behavior were designed specifically for this application method, increase the efficiency of immersion lubrication considerably.

It is important to know the operational limits of these modern fluids to help avoid critical situations caused by ambient temperature extremes. The safety of the immersion lubrication system is based on the fact that either the pinion or the gear

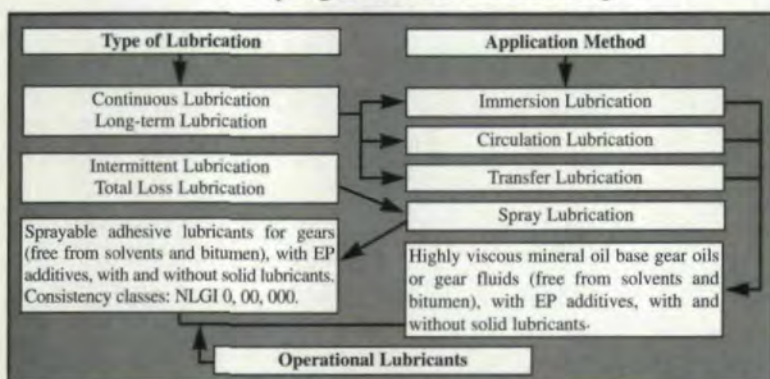

Fig. 1 — Common types of lubrication and application methods for large gear drives.

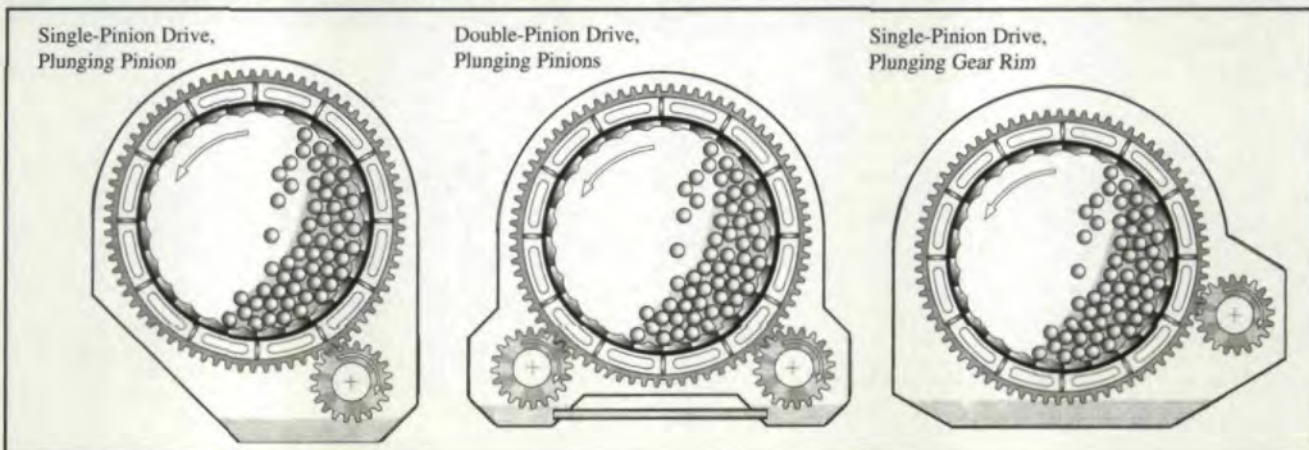

Fig. 2 — Types of immersion lubrication.

is in direct contact with the lubricant reservoir (Fig. 2). To ensure this system's reliability and prevent deficient lubrication, it is important to regularly compensate for lubricant losses from leakage or lubricant discharge through the gear rim seals. Inadequate sealing between the gear guard and the gear rim will result in dust, sand, clinker, water, etc. penetrating into the immersion bath. These contaminants will eventually reach the intermeshing gear tooth zone and result in increased abrasive wear of the tooth flanks. The immersion bath should be replaced at regular intervals to prevent damage to the tooth flanks caused by contamination.

The lubricant used in the immersion system should meet the following requirements to ensure a reliable and safe operation of the gear drives for a long period of time. It should

- be solvent-free.
- have good back flow behavior; channeling should not occur at ambient temperatures.
- have suitable viscosity/temperature behavior so that the bath must be neither heated nor cooled.
- have low evaporation losses.
- have easy replacement and disposal.
- have load-carrying capacity and antiwear behavior confirmable on the FZG gear testing rig.

Transfer Lubrication

In this type of lubrication, also called paddle wheel lubrication, paddle wheels plunge into the lubricant reservoir and then transfer the lubricant to the driving pinions. This method has the advantage that smaller amounts of lubricant are transferred to the tooth flanks and a smaller amount of excess lubricant is in circulation at the drive. Fig. 3 shows an example of paddle wheel lubrication of a rotary kiln with a double-pinion drive. The paddle wheels are located directly below the pinions and are driven by them. Paddle wheel lubrication is only suitable for spur-toothed gear drives and is mainly found on slowly operating kiln drives.

Circulation Lubrication

In circulation lubrication, the lubricant is transferred by means of externally driven pumps. The main advantage, as compared to immersion lubrication, is the fact that the lubricant is filtered and then applied in an excess amount to the tooth flanks almost without contaminants. Circulation lubrication will be successful only if the gear guard is sealed properly and the penetration of contaminants from the environment into the lubricant reservoir is prevented as much as possible. Most circulation lubrication systems used today are designed for the application of gear oils. Some systems are also suitable for applying high-viscosity

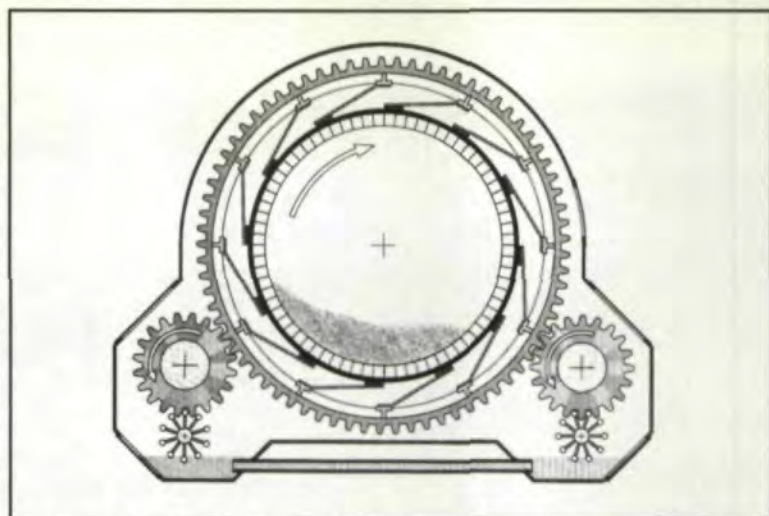

Fig. 3 — Transfer (paddle-wheel) lubrication, double-pinion kiln drive by FLS.

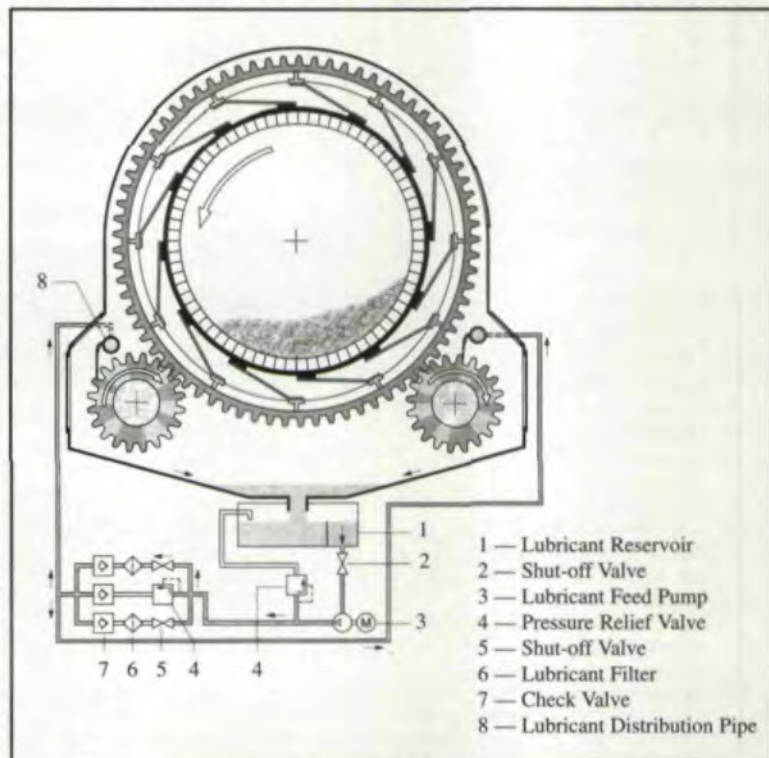

Fig. 4 — Circulation lubrication system for double-pinion drives (schematic view).

open gear fluids used in running-in lubrication, as well as operational lubrication. The typical circulation lubrication system is suitable for lubricating drives on kilns and mills and can also be retrofitted to existing installations. For large open gear drives, its main advantage is that the lubricant is continuously cleaned by filters and that it is applied to the tooth flank surfaces very efficiently through special lubricant distribution pipes. Fig. 4 is a schematic of a circulation lubrication system for a double-pinion drive.

A schematic of a circulation lubrication system with various accessories is identified in Fig. 5. From the lubricant reservoir (1.1), which is filled directly from the gear guard (4), or by means of a transfer pump (5), the lubricant is fed by gravity flow to the lubricant pump (2.1) via a

Dennis A. Lauer

is Vice President, Engineering at Klüber Lubrication, N.A., a lubricant manufacturer in Londonderry, NH. He is the author of numerous papers and articles on lubrication subjects.

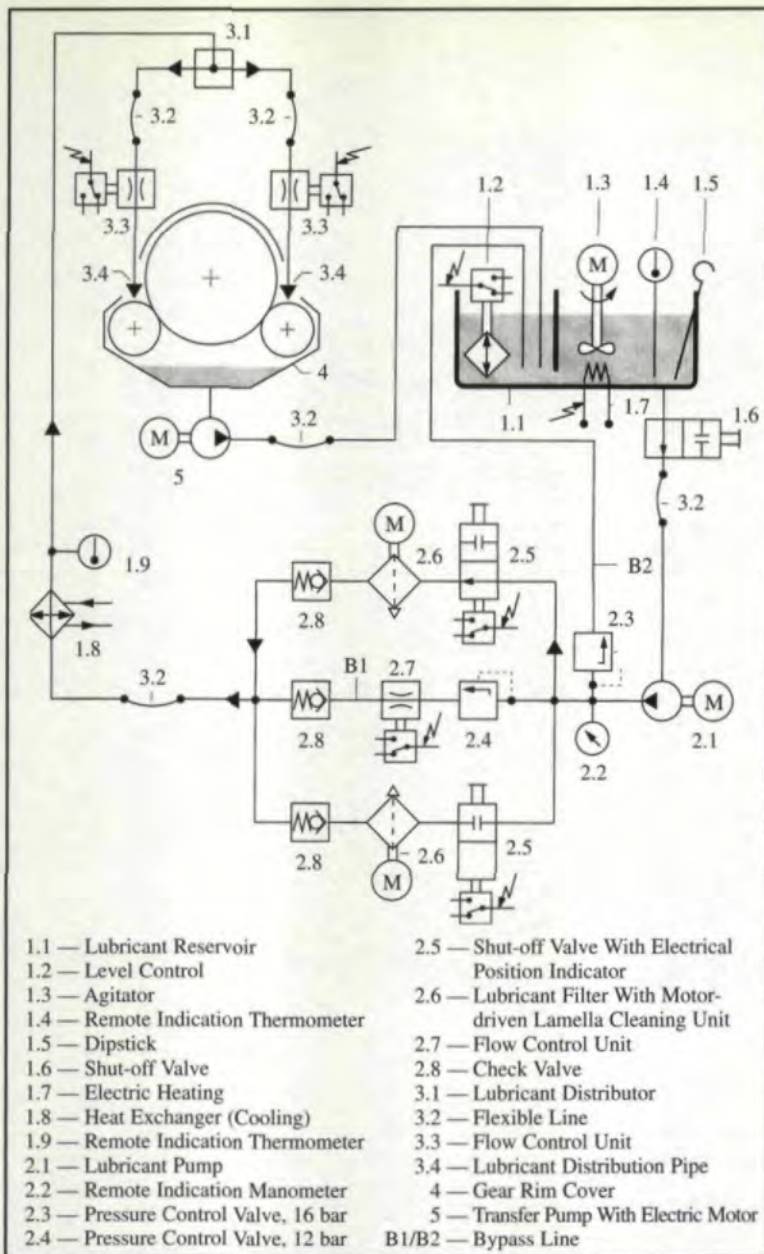

Fig. 5 — Schematic of a circulation lubrication system with various accessories.

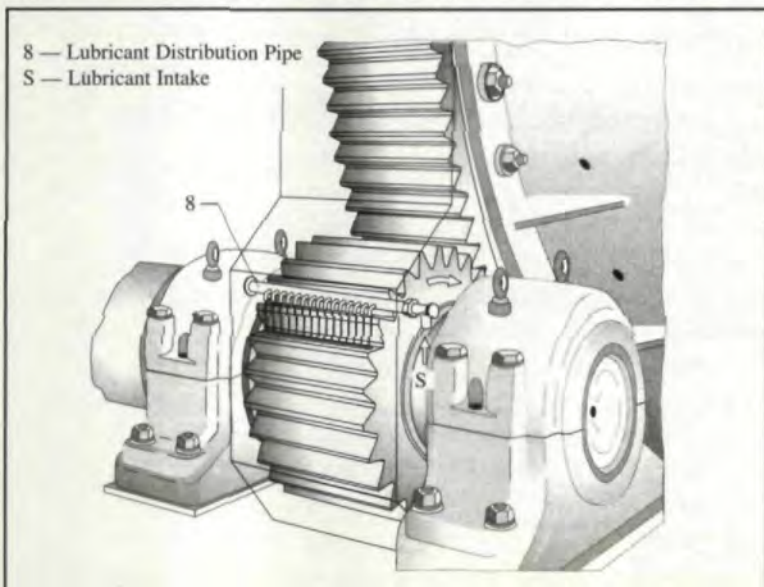

Fig. 6 — Lubricant application through specially designed lubricant distribution pipes.

pipe system. Depending on the position of the valves (2.5), it is transferred to one of the two filter units (2.6), which are equipped with a motor-driven cleaning mechanism. Since only one filter is operating at a time, the other can be maintained and cleaned without interrupting the flow of lubricant to the gears. Switching from one filter unit to the other can be accomplished manually or automatically. The recommended filter size is between 80 and 100 microns.

After passing the filter unit, the lubricant is fed through a distributor (3.1) to the distribution pipes (3.4). A check valve (2.8) prevents the lubricant from flowing backwards. If there is not enough flow through the operating filter unit (2.6), the pressure relief valve (2.4) will open. The lubricant is then supplied to the distribution pipes via the bypass line (B1). A flow control unit (2.7) installed in the bypass line will trigger an alarm, which will warn the operator to change the flow to the other filter line. The lubricant flow is then directed through the second filter unit, and the pressure relief valve (2.4) will close as soon as the pressure is reduced. The monitoring of system alarms is very important in order to prevent prolonged application of unfiltered lubricant to the tooth flanks. It is also possible to have an automatic system to control the flow direction into each filter unit based on pressure drop in the filter lines.

Flow control monitoring is also located before the distribution pipes to ensure that there is lubricant flow to the gear teeth. Fig. 6 shows the location of the lubricant distribution pipe.

If required, the lubricant reservoir (1.1) can be equipped with a heating system (1.7) and agitator (1.3). If cooling of the lubricant is necessary, a heat exchanger (1.8) can be installed in the lubricant line in front of the distribution lines (3.4). If the space available directly below the gear guard is restricted and it is not possible to install a lubricant reservoir there for a gravity flow, then a transfer pump (5) can be used.

Intermittent Lubrication

Intermittent lubrication means that the lubricant is applied at intervals. This type of lubrication is always total loss lubrication; therefore cost effectiveness has to be taken into account. Just as in the case of continuous lubrication; there are various methods of application of intermittent lubrication. For modern and safe lubrication of large girth gear drives, however, only two methods of application are used: Manual lubrication by spray gun and automatic spray lubrication.

Manual Lubrication by Spray Gun

Currently, the most effective type of manual lubrication for large gear drives is by means of

pressurized manual spray guns. They are best suited for operational lubricants in cases where stationary automatic lubrication systems cannot be installed and where lubrication is required during operation. A typical manual spray lubrication system is depicted in Fig. 7. This portable equipment consists of a pressurized lubricant container with valves, a heavy-duty spray gun and connecting hoses for the lubricant and pressurized air. This system is easy to handle and only needs to be connected to the plant air system before it can be put into operation. With the spray gun, which can be adjusted to a round or flat jet, different types of lubricants can be applied:

- Operational lubrication with very thin lubricating film and economical consumption.
- Priming of open gear drives to check the contract and load-carrying pattern.
- Lubricant application for repair correction or forced run-in lubrication.

Automatic Spray Lubrication

Manual lubrication by means of a spray gun as described in the previous section has its limits in running-in and operational lubrication, especially when large drives have to be lubricated adequately and reliably. Automatic spray lubrication is especially suitable for gear drives that, due to their design and inefficient sealing of the gear guard, are not suitable for other types of lubricant application, and where heat dissipation by the lubricant is not necessarily required. Various manufacturers offer automatic spray lubrication systems of different designs, all of which are state of the art and are capable of handling operational lubricants with a high solid lubricant content, as well as special running-in lubricants. Ideally, the amount of lubricant sprayed onto the tooth flanks maintains a minimum thickness of lubricant film. This thickness is constantly diminished by the motion of the two flanks against each other. If the necessary film thickness is maintained, it will prevent scuffing caused by insufficient lubrication. However, this is hardly feasible for technical reasons.

It is quite obvious that during operational lubrication it is not possible to continuously apply a lubricant film of optimum thickness to the tooth flanks. A good compromise is found in interval lubrication, consisting of periods of excess lubrication. For operational reliability, the most decisive factor is the duration of the individual spraying pulse. It is best when the entire circumference of the pinion or the girth gear is sprayed and covered with lubricant in one pulse. The lubricant amounts must ensure a film thick enough to reliably last through the ensuing

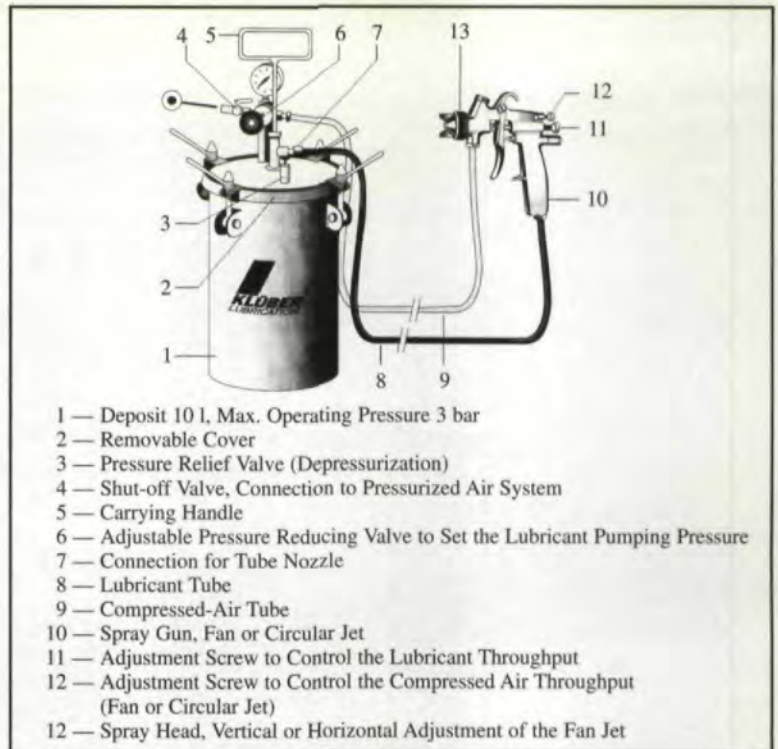

Fig. 7 — Manual spraying equipment.

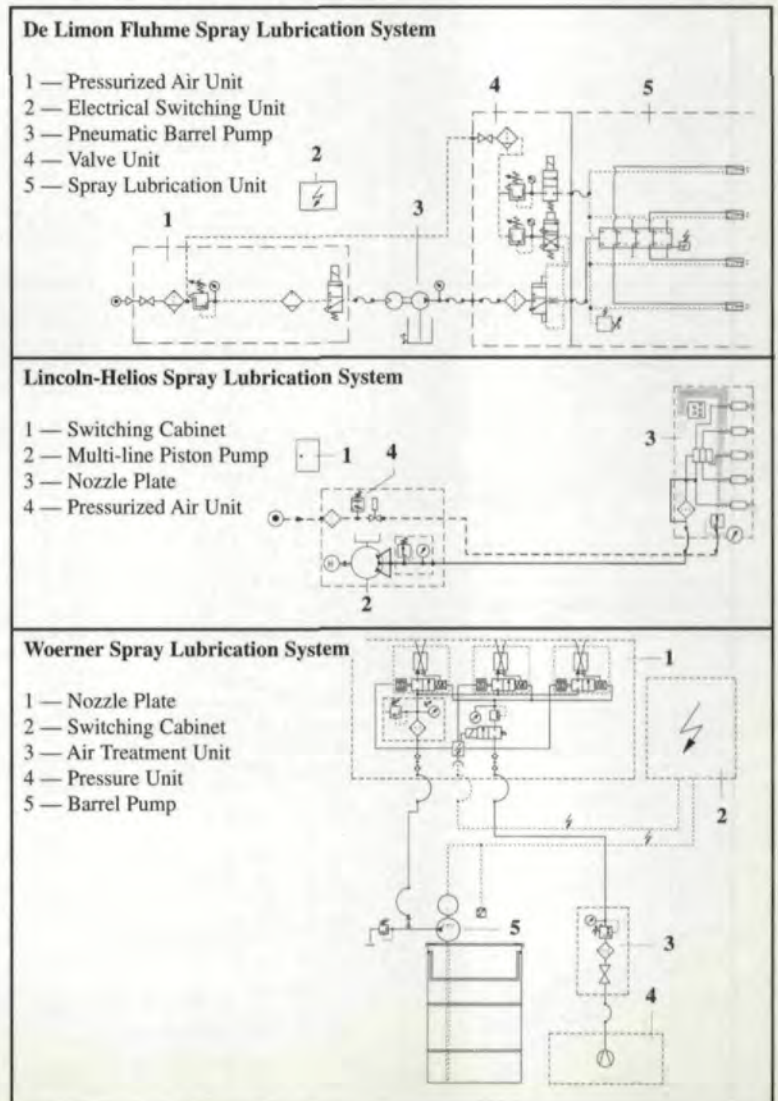

Fig. 8 — Spray lubrication systems.

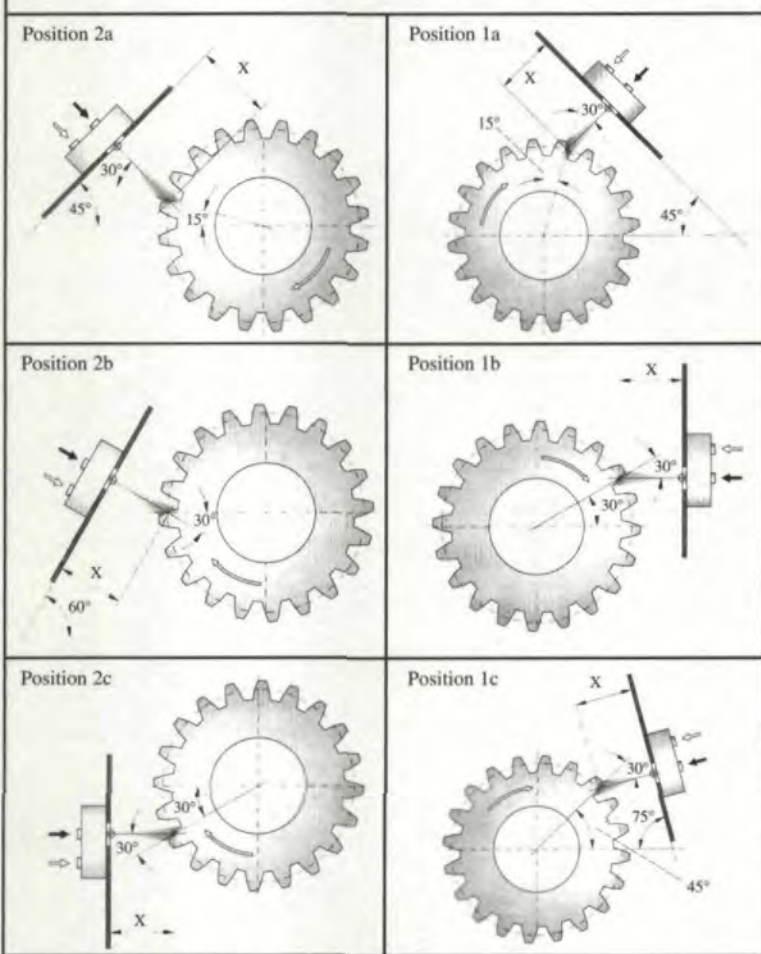
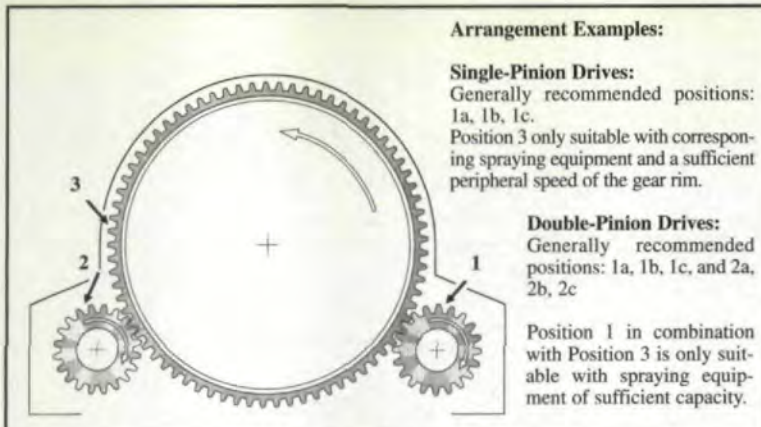

Fig. 9 — Nozzle plate arrangement.

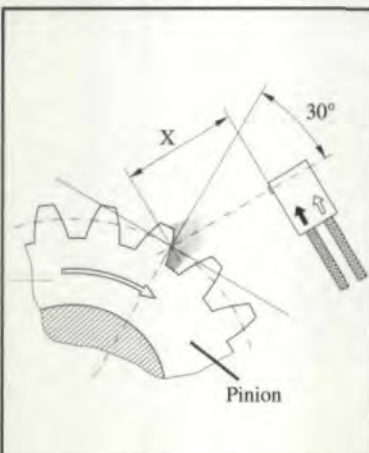

Fig. 10 — Preferable orientation of a spray nozzle.

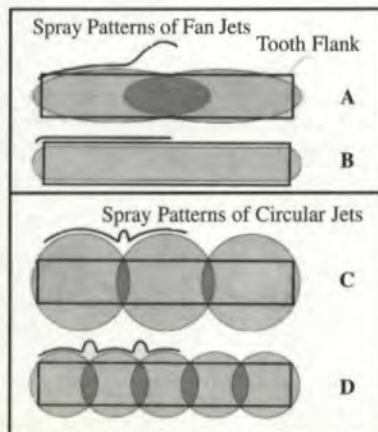

Fig. 11 — Spray patterns on gear tooth flank surface, depending on the number of nozzles and the spray geometry.

pause cycle. More frequent spray cycles with the shortest possible pauses result in the maximum operational reliability in spray lubrication.

Fig. 8 shows schematic diagrams of spray lubrication systems from different manufacturers that are used today for spraying lubricants on large girth gear drives. These systems differ in their design and components as follows:

- Lubrication pumps, e.g. electromechanical multi-line piston pumps (container pumps) with manual filling and automatic filling by means of pneumatic barrel pumps, or direct pumping by means of pneumatically or electromechanically driven drum pumps.
- Single or dual-line system design.
- Lubricant feeding to the spray nozzles either direct from the lubricant pump or via an intermediate progressive distributor.
- Auto-control spray nozzles (controlled by the lubricant and/or air) or externally controlled nozzles with or without monitoring units.

Fig. 9 shows the optimum arrangement of nozzle plates found by practical experience. Positions 1 and 2 are generally preferred. Spraying of the girth gear in position 3 should only be considered if it can be ensured that the entire circumference of the gear is covered with lubricant during one spray pulse. This applies especially to slow running kiln gears. Depending on the design of the gear guard, the nozzle plates should be arranged at the angles and positions indicated in Fig. 9. The spray nozzles should not be installed in a vertical upward direction, since they could become clogged by used lubricant. This would result in insufficient spray patterns and eventually in a complete failure of the lubricant supply system. When determining the position of the nozzles, especially when the girth gear is to be sprayed, the safety of the maintenance personnel when working on the system must be considered.

In Fig. 10, the orientation of the spray nozzle is indicated. A spraying angle of 30° is best to achieve a good distribution of the lubricant on the load-carrying tooth flanks. The nozzle distance should be between 150 and 250 mm. The exact distance depends on the position and the type of nozzle. Each type of nozzle requires a specific nozzle distance, which depends on the air pressure as determined by the manufacturer and which ensures the entire width of the tooth flank is covered with lubricant. This distance also must take into account the number of nozzles and the type of lubricant. Operational safety is reduced if the nozzles are not oriented properly.

An important factor of operational reliability is a perfect spray pattern without any gaps.

The lubricant must be distributed evenly over the entire height and width of the tooth flanks (Fig. 11). Even if the spray nozzles are automatically controlled, periodic checking of the spray pattern is an essential part of maintenance. Due to their design, older spray systems have the disadvantage that the spray pattern in high-speed drives, such as mills, can only be checked when the drive is stopped. This disadvantage can be removed by newly developed nozzle plates that make it possible to check the spray pattern while a drive is in operation.

Fig. 12 shows various nozzle plate designs. This is of special advantage on kiln drives, which cannot be stopped at random. In addition, this type of checking ensures maximum protection against accidents because it is not necessary to remove the gear guard.

Depending on the system design, the lubricant can be delivered from a container to a lubricating system by different means:

- Spray lubrication systems with container pumps (Fig. 13).
- Spray lubrication systems with drum pumps (Fig. 14).

The lubricant containers in the first system are filled manually or by means of a transfer pump out of the original package. The transfer pump is preferred because it prevents contamination of the lubricant. In the second system, the lubricant is fed directly to the spray system with the required operating pressure by means of a drum pump that is put into the original lubricant drum. Feed pumps may be driven electromechanically or pneumatically.

Summary

The goal of the lubrication system for large gear drives is to provide the optimum amount of lubricant at all times to the gearing system. This will prevent premature wear and expensive gear replacement. All of the systems discussed can provide this goal as long as they are maintained and operated properly. The cost effectiveness of each system must be analyzed by the individual user. ☉

Acknowledgement: Reprinted by permission of the Society of Tribologists & Lubrications Engineers (STLE). All rights reserved.

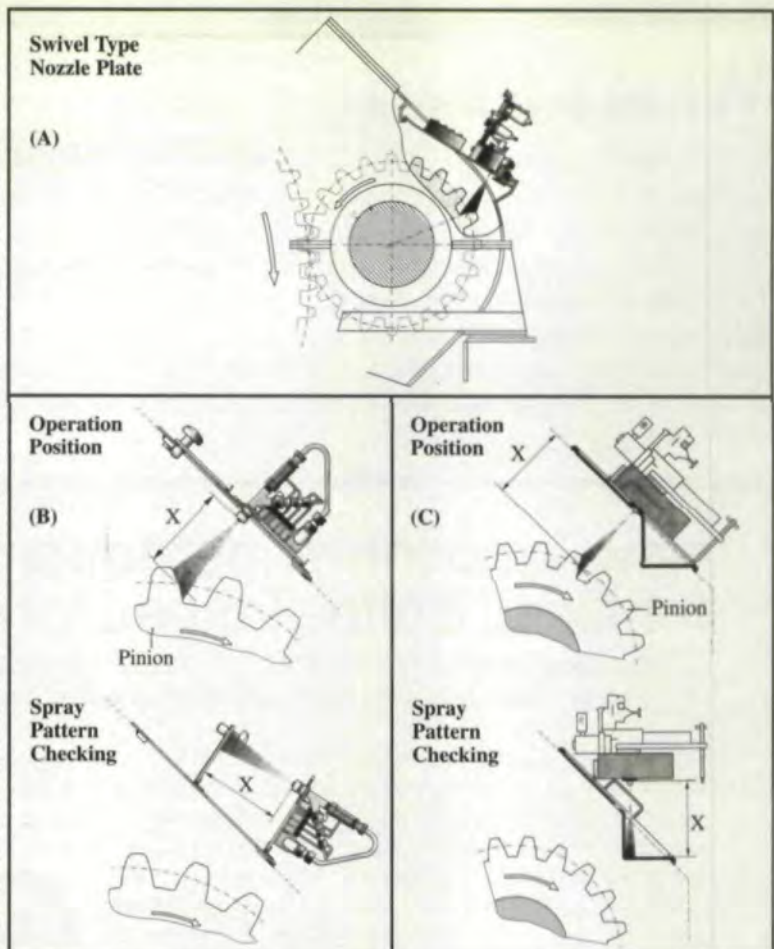

Fig. 12 — Nozzle plate systems.

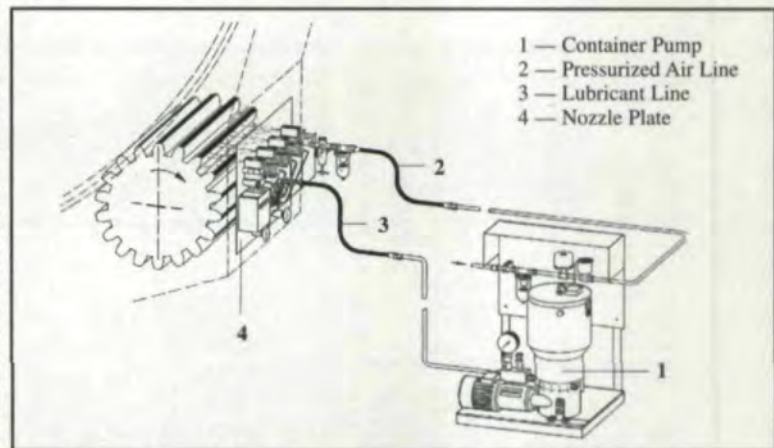

Fig. 13 — Spray lubrication system with container pump

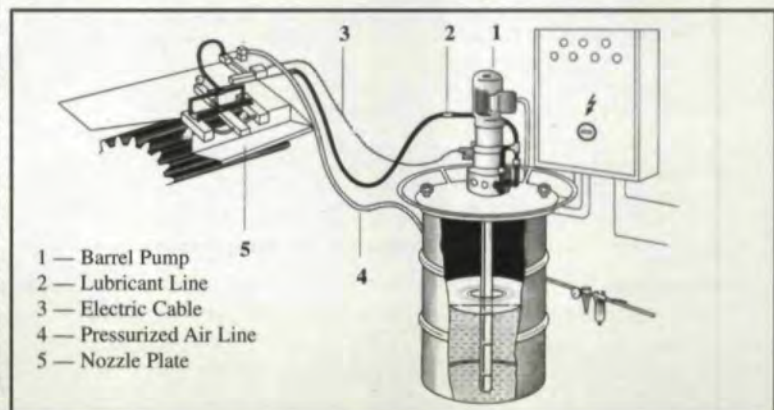

Fig. 14 — Spray lubrication system with barrel pump.

Tell Us What You Think...

If you found this article of interest and/or useful, please circle 208.

For more information about Kluber Lubrication, N.A. please circle 209.

What's News

The Latest Moves

Louis W. Ertel has joined Foote-Jones/Illinois Gear, Chicago, IL, as vice president/general manager. Foote-Jones is a manufacturer of custom gearing, enclosed drives, gearboxes and other power transmission products. Mr. Ertel comes from Prager, Inc. of New

Orleans, LA, where he was vice-president of manufacturing.

Hotline

Nord Gear Corporation of Waunakee, WI, announces the opening of its new 24-hour, 7-day-a-week customer service hotline, which will give customers access to Nord service personnel. A phone call to the 800 number will activate a beeper where the customer can leave a phone number for

immediate response from a technician. Nord promises to be able to ship new product to anywhere in the U. S. within three hours of a phone call.

Also Known As . . .

LMT-Fette, Inc., formerly known as Fette Tools Systems Inc., is part of the new LMT-Fette Group, composed of Fette, Boehlerit and Kieninger. LMT-Fette will have a new, enlarged cutting tool program including products for the mold and die making, automotive, aircraft and general metalworking industries.

Cybercompanies

Sunnen Products Co., manufacturers of industrial honing machines and automotive shop equipment, have opened a site on the World Wide Web. Accessible at <http://www.sunnen.com>, the site allows users to review listings of all available Sunnen catalogs, product brochures, technical bulletins and reference material. Information on machines, abrasives, tooling and honing fluids is also available.

CSI, provider of integrated maintenance systems and services for machinery diagnostics, has opened a web site at <http://compsys.com>. The site provides product information, news releases, training, services and customer support information.

South American Connection

Surface Combustion, Inc., manufacturer of industrial heat treating furnaces, has announced a product and technology license agreement with Sauder Equipamentos Industriais Ltda. of Brazil. Sauder will represent Surface Combustion in Brazil including product sales, service and manufacturing. Sauder Equipamentos is headquartered in Sao Paulo, Brazil.



Michael J. Huber (center) of Surface Combustion with Roberto Novak (left) and Jose Fernandes of Sauder Equipamentos.

New, Innovative Instruments for Gear, Spline Inspection

... including the industry's first 1,000-pound capacity over ball/pin size measurement system.

1. Standard Gage-O-Matic™ is the industry leader in accuracy, repeatability and ease of operation for internal/external gear or spline size. 2. Heavy Duty Gage-O-Matic easily locates and inspects small or large parts weighing up to 1,000 pounds with accuracy to 0.0001". 3. GR10-1001 is a bench top functional gear roller for checking runout deviations, tooth-to-tooth action and nicks. Also, ask about our "NEW" Hob & Cutter Sharpening Measuring Instrument! Improve quality, reduce scrap!

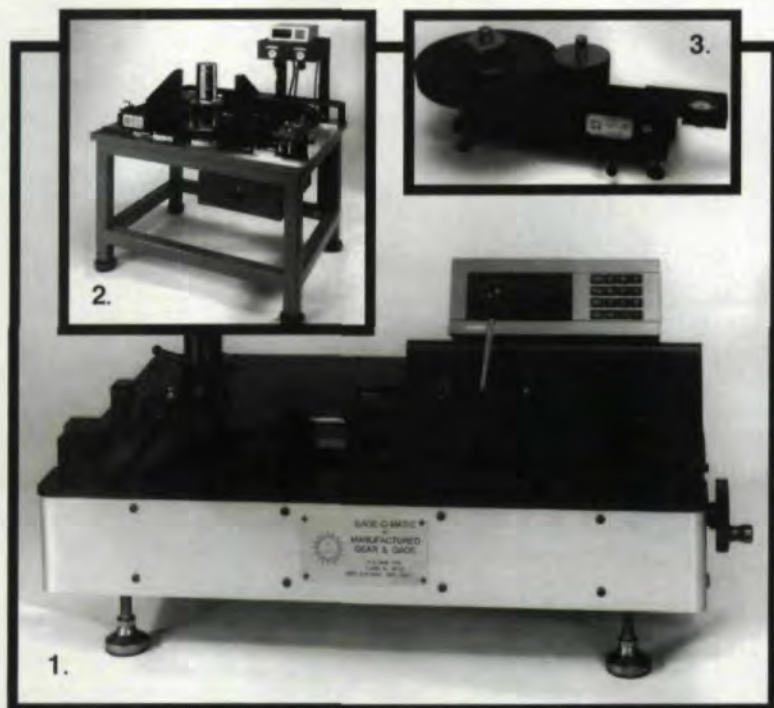

See us on the Gear Technology Home Page.

For specifications call (630) 377-2496 or Fax (630) 377-2546

MANUFACTURED GEAR & GAGE, INC.

P. O. Box 7155, Elgin, IL 60121

CIRCLE 164 or call 1-800-340-1160 x9164

500th Machine

The Gleason Works will ship its 500th Phoenix[®] CNC machine for the production of precision gears in August. The Phoenix, introduced in 1988, is the world's first spiral bevel and hypoid gear production machine requiring just six axes of CNC-controlled motion to produce all bevel gear tooth geometries for cutting and grinding. Since its introduction, the line has been expanded to include a helical hobber and gear testing and gear lapping machines.

Materials Guarantee

Hoeganaes Corporation of Riverton, NJ has announced the most comprehensive guarantee for ferrous metal powders ever offered in the P/M industry. The guarantee covers all the company's Ancorbond[®] and Anchodense[™] processed materials and goes into effect immediately. In the guarantee, Hoeganaes assures the performance properties of the materials agreed upon with the fabricator and that these materials will work with the specific applications for which they were developed. The company will provide online support, complete laboratory services and on-site personnel at the fabricator's facility to run development trials.

New Gage System

Albion Devices, Inc., of Solana Beach, CA, an engineering firm specializing in temperature compensation of precision measurements, recently delivered a GageComp-M2 multichannel temperature compensation system to K. J. Law Engineers, Inc. The unit was installed on an automatic gage developed by Law for American Axle & Manufacturing, Inc., to measure brake drum and pilot bores. The Albion system uses sensors to monitor the temperature of the workpiece, master and gage fixture.

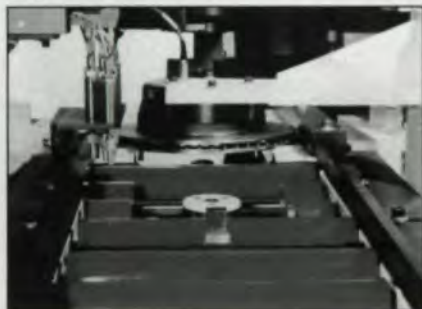

Brakedrum in new Albion gage.

Expanded Facilities

Romer, Inc., manufacturer of portable CMMs, has expanded its Dearborn, MI, operations with a new, larger sales/service/training facility. The 4,300 sq. ft., multi-level facility houses a Romer sales office for Michigan, Ohio and Indiana, plus a full service center for Romer portable inspection systems. The company has also added two more applications engineers to its staff to provide

customer service support for portable CMM customers. In addition, Romer has contracted with Crescent Gage of Dallas, TX, to handle sales of Romer portable articulate arm CMMs and related hardware and software in Texas, Louisiana and Oklahoma. ⚙

Tell Us What You Think...

If you found this article of interest and/or useful, please circle 210.

**TOS ČELÁKOVICE
GEAR HOBBIING AND SHAPING MACHINES**



Gear Hobbing Machine, Model OFA 32 R

TOS ČELÁKOVICE offers **Gear Hobbing and Shaping** machines in manual and CNC versions. The machines accept workpiece diameters ranging from 6"-27" and are suitable for single piece and batch production.

The **Gear Hobbing** machines are capable of precision hobbing of external spur and helical gears, sprocket wheels, and worm wheels using the radial and tangential methods, and spline shafts and other profiled components using the generating method.

- Features include:
- Static and dynamic rigidity
 - Automatic work cycles
 - Infinitely variable hob speeds
 - Hydraulic clamping cylinder
 - Capability of conventional and climb milling
 - Repeat hob cutting

The **Gear Shaping** machines are designed to shape external and internal spur and helical gears, sprocket wheels, gear segments, racks, clutches, cams and other profiled components in the generating method.

- Features include:
- Hydrostatic ram spindle bearing
 - Automatic work cycles
 - Infinitely variable double strokes and circular feeds
 - Option of radial plunge cut or radial plunge cut with rolling
 - Selectable cutting cycles

For more information write, phone, or fax:

WMW Machinery Company, Inc.
44W High St.,
West Nyack, NY 10994
Phone: (914) 358-3330
Fax: (914) 358-2378



Visit Us At Booth # 4358

CIRCLE 127 or call 1-800-340-1160 x9127

Powder Metal Gear Design and Inspection

Howard I. Sanderow

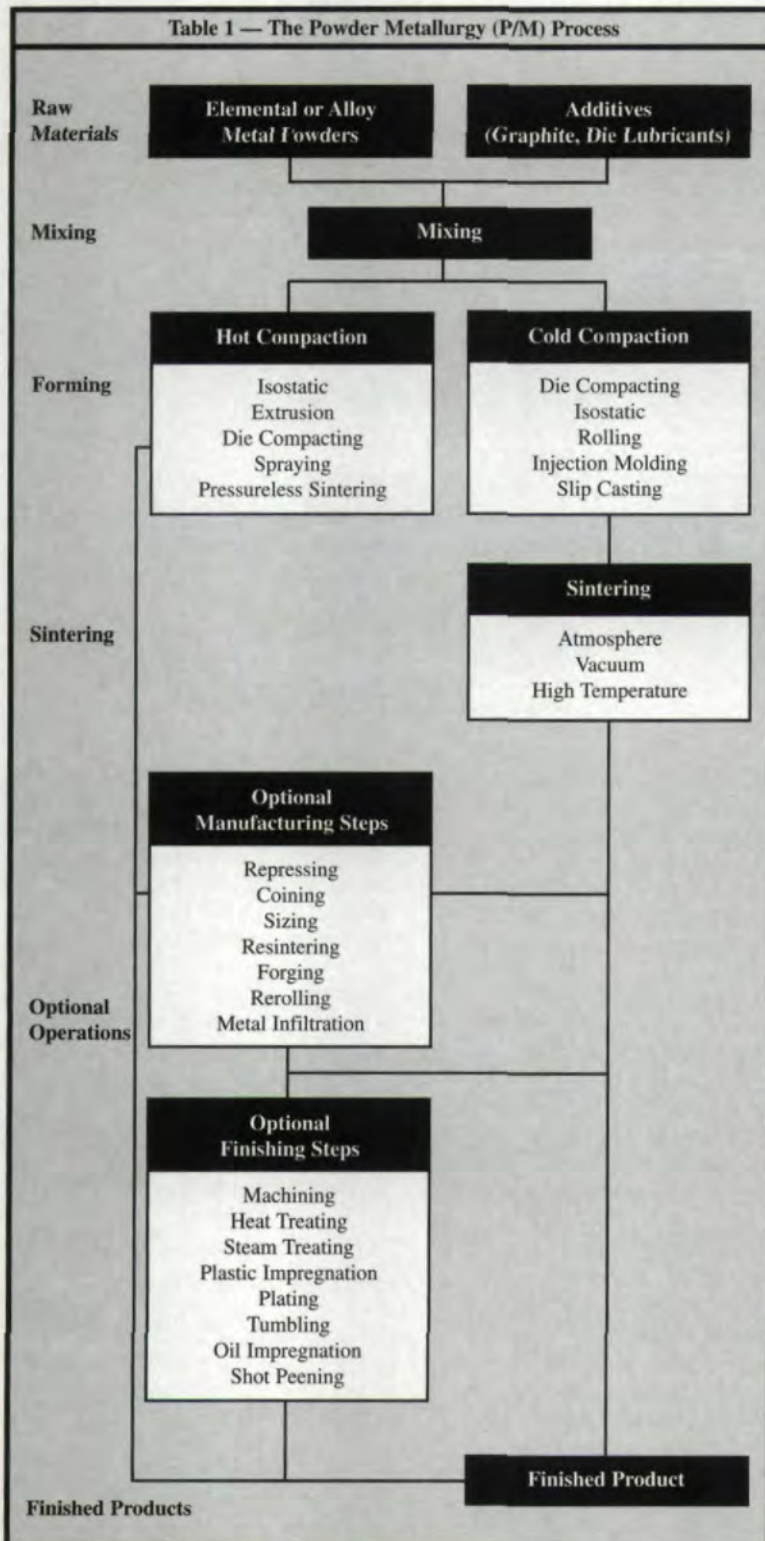

Powder metallurgy (P/M) is a precision metal forming technology for the manufacture of parts to net or near-net shape, and it is particularly well-suited to the production of gears. Spur, bevel and helical gears all may be made by powder metallurgy processing.

The P/M process is illustrated schematically in Table 1 (Ref. 1). There are three basic steps to producing parts: mixing, compacting and sintering. Variations to these basic steps, such as infiltration, double pressing/double sintering and powder forging, may be used to increase mechanical properties. Alternatively, a machining step may be added to qualify critical dimensions or to achieve a geometric feature not possible during rigid die compaction. Powder metal parts may be through-hardened or surface-hardened as required by the intended application.

In the pressing cycle, a charge of mixed powder is delivered to the die cavity by a feed shoe, and the upper and lower punches are used to compact the powder. After the upper punch is withdrawn, the pressed compact is ejected by the lower punch, and the feed shoe slides the part away from the die cavity. The cycle repeats as the feed shoe continues forward and refills the die cavity with another charge of powder.

Among the advantages of making gears by this process are that true involute gear forms are possible and that special features such as keyways, drive lugs, splines and cam contours may be incorporated during the compaction process. Lightening holes may be added to reduce part mass, and P/M gears can be made with blind corners, eliminating the undercut relief that is needed with cut gears (Ref. 2). P/M tooling provides consistent tooth form accuracy and surface finish over long production runs. Generally, because of their porosity, good surface finish and constant tool form accuracy, P/M gears reduce noise levels.

P/M gears can be made in a wide range of gear geometries for a number of applications, including gear motors for appliances, tractor transmissions, geared drives for cranes and a number of automotive applications.

Limitations of P/M Gears

Compared to wrought steel gears, P/M gears have lower impact resistance, fatigue strength and contact stress capability. This reduction in mechanical properties (due to the presence of porosity in the microstructure) may limit the same-size replacement of wrought and cast parts by P/M gears. However, it should be noted that the double-press/double-sinter process or warm compaction can overcome some of these limitations. Higher temperature sintering or case hardening can also improve the performance of P/M gears. Bending stress limitations may be overcome by using the versatility of P/M gear technology in the fillet radius design. If the design space permits, a larger P/M gear may be substituted.

For certain gear geometries, such as bevel and helical, the tooling motion cannot provide as high a tooth density as is possible in spur teeth. A portion of the applied pressure is lost to frictional effects in helical gears. Insufficient powder motion causes lower density in bevel gear teeth. Frequently copper infiltration is used to increase the density (and the corresponding mechanical properties) for both helical and bevel gears.

The face width of P/M gears is also limited. The constraints of the compaction process limit face widths to well under 3". Frictional losses between the powder and the die cause decreasing density along the face width, the lowest being at the midpoint. This is a reciprocal relationship, with greater face widths having larger density decreases. Dimensional variations can also occur during sintering and heat treating, which may lead to distortion, especially with larger gears.

Gear Design Data

P/M gear design data requirements are quite similar to those for machined gears. The AGMA Powder Metallurgy Committee has been working on the development of a new standard, "Powder Metallurgy Gear Specifications," for the past two years. This specification is expected to include sections for basic data, inspection data, calculation and process test data, as well as reference data.

Even after specifying the gear data in detail, certain geometric features or special notes should also be considered at the design stage:

1. Denoting the bore or central datum feature.
2. Providing a squareness of bore tolerance note if functionally critical.
3. Consideration of a tooling design to accommodate adherent burrs on the teeth edges.
 - a. Chamfers on teeth
 - b. A raised boss on the gear face to act as a 0.010" spacer between gears so small burrs do not interfere with proper rotation of the gears.

4. An allowance for minor surface defects, such as nicks or minor amounts of raised metal from a vibratory finishing operation.

5. Including an allowance for missing material (if possible).

6. An allowance for an identification mark on a gear face to assist in tool orientation during compaction and gear inspection after processing.

Proper consideration of these items during preliminary design discussions, either as specific design details on the part print or as off-line quality planning agreements, will ensure the P/M gear is specified correctly.

Mechanical Design Criteria

Once the geometric features of a P/M gear are determined, the next step is evaluating the mechanical loads on the product. Typically these requirements will include a normal operating load and a potential overload condition. Two types of failure modes should be considered:

- Tooth bending fatigue failure, and
- Tooth overload failure.

The AGMA Powder Metallurgy Committee is also reviewing methods of evaluating the mechanical operating characteristics of P/M gears. One of the goals of the committee is to provide a simple equation for determining the load capacity of P/M gears (spur, helical and bevel) once certain mechanical properties of the P/M steel materials are known. For instance, an equation of the form shown below has been suggested.

$$T = \frac{S K_1 d F J}{2 P d K_2}$$

Where

T = torque load capacity (in-lbf)

S = design strength (lbf-in²)

K_1 = constant

d = calculation diameter (in)

F = effective face width (in)

J = geometry factor

Pd = diametral pitch (in⁻¹)

K_2 = constant

The design strength, S , would be the fatigue strength when determining the torque capacity under repeated loading or the yield strength when determining the torque capacity under a sudden, overloading condition. Once the material property, S , has been determined and the gear geometry is known, the torque load capacity, T , can be calculated. This value is then compared to the actual torque load expected by the gear. If the calculated T is less than the actual load, a failure is predicted; if T is greater than the actual torque load, then an acceptable material has been selected for the design conditions.

Howard I. Sanderow

is the president of Management & Engineering Technologies, Dayton, OH. He has written a number of articles and presented seminars on powder metal subjects.

Table 2 — Typical Manufacturing Tolerances for Heat Treated P/M Steel Gears

P/M Gear Quality Manufacture Process					
Gear Size Pitch Diameter mm	Max Runout µm	Tooth-to-Tooth Error µm	Total Composite Error µm	AGMA Class (Approx.)	Secondary Operation
16	35	40	75	7	None
	25	30	55	8	Size
	20	20	40	9	Bore
40	45	40	85	7	None
	35	25	60	8	Size
	25	20	45	9	Bore
100	75	55	130	6	None
	60	40	100	7	Size
	45	40	100	7	Bore

Values for DP = 32 Module = 0.75
Finer pitch requires closer tolerances to meet same AGMA class.

A second type of mechanical limit or failure mode encountered in gear designs is wear or pitting fatigue failure. This type of failure, also known as contact fatigue or surface fatigue, is normally associated with highly stressed, heat treated steel gears. Only recently has experimental work begun toward a systematic evaluation of the surface fatigue phenomenon as pertaining to P/M steel alloys (Ref. 3).

Until the AGMA Powder Metallurgy Committee completes its work in the area of mechanical performance characteristics, P/M gear designers will be forced to utilize other approximations for determining load capacity. One of the early studies of P/M gears (Ref. 4) suggested using the gear rating formula (as now found in AGMA 2001-B88), but modified for P/M steels. An approximation for the bending fatigue strength was to use 30% of the tensile strength. The approximation for the allowable contact stress was the tensile strength minus 10,000 psi.

These estimates are slightly conservative in light of more recent studies, which find the mean fatigue life closer to 32% of the tensile strength for heat treated P/M steels (Ref. 5), and the contact fatigue strength for a high density, heat treated nickel steel (FN-0205-180HT) about 10,000 psi greater than the tensile strength (Ref. 3). A recent Japanese study (Ref. 6) evaluated actual P/M gears for tooth bending fatigue. Contact fatigue limits were developed from a sliding roller test rig. Gear running tests were also conducted using a power circulating testing machine for comparison with these fatigue tests. Their results indicate improvement in bending fatigue strength through

- increased density,
- increased sintering temperature,

- shot peening after case hardening,
- heterogeneous microstructure.

The contact fatigue limit of about 190,000 psi for the 4% nickel steel in the Hirata study was lower than the value reported by Prucher et al. due to the lower density (7.1 vs. 7.4 g/cm³) and difference in heat treatment (case-hardened vs. through-hardened). These investigators also noted that contact fatigue (spalling) was the predominant failure mode in the gear running tests, but that the contact fatigue life was increased 15–20% compared to the roller RCF tests. They concluded that the load bearing capacity of case-hardened P/M steel gears was higher than that of Tufftrided® AISI 1045 wrought steel gears.

P/M Gear Inspection

The quality of P/M gears is determined using the same type of inspection equipment as is used for machined gears:

- A rolling or composite gear checker for fine pitch gears,
- An involute or element gear checker for coarser pitch gears.

Typical manufacturing tolerances that can be expected for heat treated P/M steel gears are summarized in Table 2. As the size of the gear increases, the tolerance limits must also increase, since size changes in sintering and heat treatment are direct percentages of lineal dimensions. For small-to-medium size gears, an AGMA Q7 gear is quite feasible with no extra processing. A sizing or boring operation is needed to reach Q8 or Q9 tolerances. For much larger gears (4–6" pitch diameter), the as-manufactured tolerances are greater, resulting in a Q6 gear without any secondary operation.

Mechanical testing of a statistically representative sample from each production lot is used to demonstrate the mechanical quality of the product. Test methods include tooth torque tests or tooth breaking strength tests (either static or impact loading).

Advances to Further Improve P/M Gears

Efforts are already underway at specific P/M gear manufacturers, as well as at powder producers and process equipment suppliers, to improve both the dimensional control and the mechanical properties of P/M gears.

Dimensional Control. The dimensional consistency of gears can be improved either in the sintered condition or through the heat treatment process. One method, which is said to create AGMA Q9 gears from a Q6 gear, (Refs. 7-8) is the surface rolling of a sintered P/M gear against a master gear. Sinter-hardening P/M gears can reduce the distortion associated with more conventional quench and temper heat treatment processes.

Tooth Density Increase. Four primary methods to increase P/M gear tooth density are under study.

1. **Roll Densification.** This effective dimensional control method also densifies the gear tooth surface. Improvement in bending fatigue strength of 32% and a 3.5 times increase in contact fatigue stress has been reported for case-hardened 4600-type P/M steel gears subjected to this process (Takeya et al.). Contact fatigue strength of 96% of that of case-hardened wrought AISI 4118 steel has also been reported.

2. **Warm Compaction.** This process is much the same as conventional powder metal part compaction, except that both the metal powder and the tooling are heated to approximately 300°F before processing. In preliminary tests, gears manufactured using warm compaction showed an increase of 30% in tooth break load. When the process was coupled with high-temperature sintering, the improvement was over 50% (Ref. 9).

3. **Rotopressing.** The Rotopressing process, which subjects parts to large tangential stresses, causing intense, local plastic flow and densification, has been reported to give densities greater than 7.6 g/cm³ in sintered P/M gear teeth, leading to excellent fatigue and wear properties (Ref. 10).

4. **Ausrolling.** This process combines surface densification and heat treatment (Ref. 11). Ausrolling of a conventional P/M steel is reported to have reduced the surface porosity from 14% to less than 2%, increased the rolling contact fatigue endurance by more than 10 times and led to substantial improvements in gear accuracy and surface finish (Ref. 12).

Conclusions

The powder metallurgy process can provide gear designers with a cost-effective alternative to machined, wrought steel gears. This net shape process offers dimensional tolerances and mechanical properties compatible with many market applications. As current process improvements and material developments are incorporated, more high performance transmission gears will be converted to powder metallurgy. ○

References

1. *Powder Metallurgy Design Solutions*. Metal Powder Industries Federation, Princeton, NJ, 1993.
2. *Powder Metallurgy Design Manual*, Second Edition, Metal Powder Industries Federation, Princeton, NJ, 1995.
3. Prucher, T. and H. I. Sanderow. "Surface Fatigue of P/M Alloys." *Advances in Powder Metallurgy & Particulate Materials—1994*. Vol. 2, Metal Powder Industries Federation.
4. Smith, W. E. "Ferrous-Based Powder Metallurgy Gears." *Metals Engineering Quarterly*. November, 1974.
5. Lin., S-Y et al. "A Comparison of Tensile, Rotating Bending Fatigue, and Axial Fatigue Test Results of P/M Alloys." *Advances in Powder Metallurgy & Particulate Materials—1994*. Vol. 7, Metal Powder Industries Federation.
6. Hirata, H. et al. "Loading Bearing Capacity of Ferrous Sintered Gears." *Proceedings of the 1993 Powder Metallurgy World Congress*, Kyoto, July 12-15, 1993, Japan Powder Metallurgy Association.
7. Takeya, Y. et al. "Surface Rolling of Sintered Gears." SAE Technical Paper 820234, Society of Automotive Engineers, 1982.
8. Cofer, J. and P. Winterton. "High Performance P/M Gearing." Presented at SAE Congress, Detroit, MI, March 1993.
9. Chmelar, J et al. "Evaluation of the Ancordense Single Compaction Process and HPP Processing Techniques in Fine Pitched Spur and Helical Gears." *Advances in Powder Metallurgy and Particulate Materials—1994*. Vol. 5, Metal Powder Industries Federation.
10. Miskiewicz, L. "Ultra High Metal Powder Densification for Manufacturing Highly Loaded Automotive Parts." SAE Technical Paper 940387, Society of Automotive Engineers, 1994.
11. Kuplen, S.T. et al. "Ausrolling Sintered Steels for Bearing Elements." *Advances in Powder Metallurgy & Particulate Materials—1992*. Vol. 2, Metal Powder Industries Federation.
12. Sonti, N. et al. "Ausform Finishing of Gears." *Industrial Heating*. April 1995.

Acknowledgements: Longer versions of this material were presented at the 1995 AGMA Fall Technical Meeting and at the 1996 SME 1st International Advanced Gear Processing & Manufacturing Conference. They are available from AGMA as 95FTM13 and from SME as "Powder Metallurgy Gears—Expanding Opportunities" by James & Sanderow.

Tell Us What You Think...

If you found this article of interest and/or useful, please circle 211.

For more information about Management & Engineering Technologies please circle 212.

AGMA & MPIF Develop Standards, Information Sheet for Powder Metal Gears

A GMA and members of the Metal Powder Industries Federation (MPIF) are three years into a joint project to develop specifications and an information sheet on rating powder metal gears. According to committee vice chairman Glen A. Moore of Burgess-Norton Mfg. Co., the first phase of the project, the publication of AGMA Standard "6008-AXX, Specifications for Powder Metallurgy Gears," should be completed in late 1996 or early 1997.

The object of the standard is to spell out through descriptions and examples the minimum data needed to adequately specify P/M gears. It covers external spur, external helical and straight bevel gears, the types most often made by the conventional P/M process. The subjects covered include gear tooth geometry data, gear drawing specifications and gear material specifications.

Moore points out that 6008-AXX is still a work in progress. The draft is almost complete, but has yet to go through the formal AGMA process of review and approval.

The standard addresses the long-standing powder metal industry concern about the lack of information available to gear purchasers to properly convey their gear design intent to the gear producer. The lack of properly detailed gear data often leads to confusion and delays in quotations and deliveries and in manufacturing gears for particular applications.

"This standard addresses a long-term need," says Moore. "As powder metal gears appear in more and more applications, it's important that this information becomes available."

Powder metal part producers like Burgess-Norton welcome this joint effort, which has produced the first AGMA standard for powder metal gears. They feel it constitutes recognition of the fact that P/M is a viable alternative to wrought metal in some applications. Tables 1 and 2 are samples of this data.

The Bending Load Rating Information Sheet

The second part of this joint AGMA/MPIF project is an information sheet, "9XX-AXX, Calculated Load Capacity of P/M Gears," which will contain rating procedures and data on the failure of powder metal gears caused by bending loads, either as fatigue failures brought on by repeated loading or as breakage or yielding caused by a temporary overload condition.

The wear and pitting modes of failure have been omitted from the information sheet for a number of reasons. AGMA standards for wrought metal gears do not cover the wear mode of failure because it is successfully avoided in most cases by proper lubrication. Although the wear mode is common enough in P/M gears where adequate lubrication is not practical, the limited data available and the complexity of the issues involved forced the decision to follow the present practice, according to Moore.

Inadequate test data for pitting in P/M gears made eliminating it from the information sheet necessary as well. Furthermore, the committee felt that omitting pitting data would not be a significant handicap to the usefulness of the information sheet because this mode of failure is



Courtesy of Burgess-Norton Mfg. Co.

P/M gears are available for a wide variety of applications.

Table 1 — Basic Data Required to Describe Gear in General Terms

SPECIFICATION	TYPE OF GEAR		
	SPUR	HELICAL	STRAIGHT BEVEL
Number of Teeth	X	X	X
Diametral Pitch	X		X
Normal Diametral Pitch		X	
Pressure Angle	X		X
Normal Pressure Angle		X	
Helix Angle		X ¹	
Hand of Helix		X	
Pitch Angle			X
Face Angle ²			X
Root Angle ²			X
Back Angle ^{2,3}			X
Tooth Form	X ⁴	X ⁴	X

Notes:

- 1) Value of helix angle when calculated from other data specifications may be approximate due to rounding.
- 2) These data items may be shown instead on an outline drawing of the gear blank.
- 3) The outer form of P/M gears is generally cylindrical, in which case the back angle is zero degrees and this specification item may be omitted.
- 4) Tooth form may be omitted when the tooth outline is fully defined by other data.

Table 2 — Inspection Data (For Use With Composite Action Testing) Appropriate For Each Gear Type

SPECIFICATION	FILLET FORM		
	SPUR (EXTERNAL)	HELICAL (EXTERNAL)	STRAIGHT BEVEL
Specification	X ²	X ²	X ²
Outside Diameter	X ³	X ³	
Root Diameter	X	X	X
Master Gear (Spec or Data)			X
Pitch Apex to Back	X	X	X ⁴
Total Composite Tolerance	X	X	X ⁴
Tooth-to-Tooth Composite Tolerance	X ²	X ²	
Test Radius	X ²	X ²	X ²
Tip Radius	X		

Notes:

- 1) Value of helix angle when calculated from other data specifications may be approximate due to rounding.
- 2) These data items may be shown instead on an outline drawing of the gear blank.
- 3) The outer form of P/M gears is generally cylindrical, in which case the back angle is zero degrees and this specification item may be omitted.
- 4) Tooth form may be omitted when the tooth outline is fully defined by other data.

much less common than the tooth bending mode in P/M gears.

According to Moore, efforts are being made now to collect pitting data, and when it becomes available, to include the pitting mode in the information sheet will be reconsidered.

Developing the data for the information sheet will be a long process, says Moore. "It took three years to develop the specification, and the information sheet will probably take as long," he says.

The committee will take the existing AGMA formulas and plug in appropriate factors for P/M to make similar gears. Then test gears will have to be manufactured and tested to compare the actual results with the theoretical ones. Drafts of the procedures will have to be written and discussed and their calculations compared with available field experience with gears in real applications. Only at

that point will the draft be approved and circulated as an information sheet.

Eventually, as field experience increases, the information sheet could go through other revisions and be upgraded as a rating standard.

The next meeting of the AGMA/MPIF committee will be Sept. 16-17 at AGMA headquarters in Alexandria, VA. Information about participation and other committee matters is available from Mr. Bill Bradley at AGMA. ☉

Tell Us What You Think...

If you found this article of interest and/or useful, please circle 220.

For more information about AGMA, please circle 221.

For more information about MPIF, please circle 222.

EXACT & REPEATABLE GEAR DATA

TRUE PITCH DIAMETER
TOTAL INDICATED READOUT
TRUE POSITION
CONCENTRICITY
ALL IN ONE GAUGE



No set-up or master required. PC based SPC program available or RS-232 port. Precision Tungsten Carbide balls or pins for maximum accuracy. Robust construction—Each gauge custom built. Over/under digital display w/ inch or mm conversion.

PHONE OR FAX FOR BROCHURE OR DEMO

DIGITAL
INTERFACE
GEAR
INSPECTION
TERMINAL

DIGIT

P.O. Box 367 • Springboro, OH 45066 • Fax: 513/746-5103
513/746-3800

CIRCLE 157 or call 1-800-340-1160 x9157

How To Avoid Oversizing Gear Drives...

Find out how international companies use thermal rating to minimize the size of units.

AGMA's Fall Technical Meeting (FTM) is about **solutions**—solutions to common and not-so-common technical problems based on the best manufacturing practices and on new research.

Join the best engineers at the industry's event of the year. Presentations will cover automotive, aerospace and industrial gearing. Hear from:

- Peerless-Winsmith
- Falk
- Gleason
- ZF
- FZG
- Dodge
- CETIM
- Hoffer
- Boeing

Mark Your Calendar for AGMA's
Fall Technical Meeting
October 28-30 • Cincinnati, Ohio

Questions? Contact the AGMA Technical Division
1500 King St. #201 Alexandria, VA 22314-2730
Phone (703) 684-0211 Fax (703) 684-0242



CIRCLE 125 or call 1-800-340-1160 x9125

TECHNICAL CALENDAR

OHIO STATE GEAR NOISE COURSE

A three-day course on gear noise, covering measurement, analysis, diagnosis, noise reduction and dynamics, will be held at The Ohio State University **Sept. 10-12**. Contact Carol J. Bird at 614-292-3204 or fax 614-292-3163 for more information.

ASM EDUCATIONAL SEMINARS

ASM is offering the following seminars on metallurgical subjects: **Sept. 17-19**, Hardness Testing: Methods & Applications; **Sept. 23-27**, Principles of Failure Analysis; **Oct. 7-11**, Principles of Heat Treating; **Oct. 14-18**, Metallurgy for the Non-Metallurgist. For registration information, contact ASM Member Services at 216-338-5151, fax 216-338-4634 or e-mail mem-serv@po.asm-intl.org.

AGMA GEAR SCHOOL

One-week sessions on basic gear manufacturing. Both classroom and hands-on work covering hobbing, shaping and inspection. Held at Daley College, Chicago, IL. The next session is **Sept. 23-27**. Call AGMA at 703-684-0211 or fax 703-684-0242 for more information.

ASME 7TH INTERNATIONAL

POWER TRANSMISSION & GEARING CONFERENCE

In San Diego, CA, **Oct. 6-9**, this four-day conference will focus on major technical aspects of power transmission component design, manufacturing and applications. Subjects will include gear design, wear, lubrication, noise and vibration, as well as belts, bearings, couplings, chain and helicopter transmissions. Contact ASME at 212-705-7057 for registration information.

AMERICAN PFAUTER/PFAUTER-MAAG CLINIC

The companies are offering a 3-day seminar on **Oct. 8-10** at their facilities in Loves Park (Rockford), IL. The subject is modern metal removal and measuring techniques for spur and helical gears. Designed for manufacturing and process management personnel, the clinic will provide an in-depth look at modern methods, applications and hardware. For more information, contact Lisa Alexander, 815-282-3000, x328 or fax 815-232-3075.

AISE LUBRICATION SEMINAR

AISE (Association of Iron and Steel Engineers) is holding a Basic Lubrication Seminar **Oct. 20-22** at the Sheraton Station Square Hotel, Pittsburgh, PA. Subjects covered include basic concepts, test methods, bearings, gears, conservation, hydraulics, additives and more. Contact Laura Evert at 412-281-6323 x151 for more information.

AGMA 1996 FALL TECHNICAL MEETING

This year's meeting will be **Oct. 28-30** in Cincinnati, OH, and will cover topics including bevel gear manufacturing, sound and vibration, scuffing, fatigue life testing and more. To register, contact AGMA Headquarters at 703-684-0211 or fax 703-684-0242. ⚙

Tell Us What You Think...

If you found this article of interest and/or useful, please circle 213.

STAR MILLING CUTTERS ... FOR LONG-LASTING RELIEF

COME SEE US AT IMTS, BOOTH #B1-7158.



Star form-relieved milling cutters deliver greater form accuracy and longer tool life — thus improving your manufacturing quality. The top-quality Star Cutter line includes single and duplex milling cutters, special form cutters, saw blade cutters and shell or shank-type multiple-thread milling cutters.

These long-lasting milling cutters are available in a wide range of sizes and configurations, and can be ordered with or without special Gold Star thin film coatings.

Call, write or fax for more information.

Since 1927
 **Star**[®]
STARCUT SALES, INC.
Subsidiary of Star Cutter Company

P.O. Box 376
Farmington, MI 48332-0376
810/474-8200 FAX 810/474-9518

CIRCLE 150 or call 1-800-340-1160 x9128

LITERATURE MART



Cooler Carbide Grinding
Ernst Winter & Son, Inc., introduces its Reptilla™ grinding wheel, offering superior consistency for greater process control, less maintenance and less downtime in the toolroom. Its unique bonds provide cooler grinding and longer life for dry grinding carbide on standard tool and cutter grinders. Specs on available wheels included in new flyer.

Ernst Winter & Son, Inc.
Call (803) 834-4145

CIRCLE 137



Broaching Technology
Detroit Broach Company offers a brochure explaining efforts to provide the latest broaching technology at the most competitive prices. Certified by the leading names in manufacturing, Detroit Broach has a commitment to quality products and service; designing, manufacturing, resharpening, remanufacturing, troubleshooting or consulting. Please send for FREE brochure or call (800) 383-6978.

CIRCLE 193

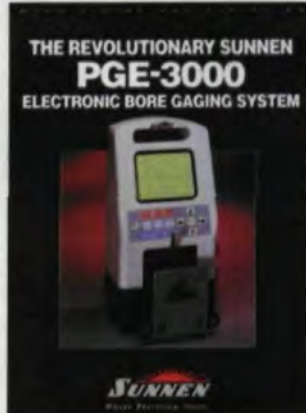

Sunnen Gaging
A new 6-page, color brochure from Sunnen Products Company gives complete specifications on the PGE-3000 Electronic Bore Gaging System that directly connects to a personal computer for statistical process control data collection. The new system eliminates the expense of master rings or plug gages and provides resolution as fine as .000010" (0.0002 mm).

Sunnen Products Company
(800) 325-3670

CIRCLE 173



Just Released . . .
PLASTIC EXPANSION ARBORS! 200-300% higher expansion rate than steel arbors. Guaranteed .00012" T.I.R. Arbor may be machined by the user to fit a specific diameter. For more information or to receive a free catalog, call 1-800-772-4865.

CIRCLE 177



G-Series Hobbers
Twelve-page, color brochure describes nine high-performance models that provide unexcelled accuracy and productivity. Simple conversational programming greatly reduces set-up time. A hardened and ground gear set and special, feed-forward servo system optimize speed while maintaining precision. MHI Machine Tool U.S.A., Inc., 907 W. Irving Park Road, Itasca, IL 60143-2023; Ph: (708) 860-4222; Fax (708) 860-4233.

CIRCLE 185



S-Series Shapers
Twelve-page, color brochure describes five highly stable gear shapers with excellent accuracy and productivity. A unique coolant circulation and Load Controlled Machining method (which automatically adjusts speed to equalize cutting force) deliver optimal machining efficiency and increase tool life. MHI Machine Tool U.S.A., Inc., 907 W. Irving Park Road, Itasca, IL 60143-2023; Phone (708) 860-4222; Fax (708) 860-4233.

CIRCLE 186



F-Series Shavers
Twelve-page, color brochure describes three high speed, high accuracy shavers that offer unprecedented machine rigidity. The simplified table, direct drive spindle, and stability-optimizing Thermal Displacement Compensation systems allow these machines to achieve unequaled long-term accuracies. MHI Machine Tool U.S.A., Inc., 907 W. Irving Park Road, Itasca, IL 60143-2023; Phone (708) 860-4222; Fax (708) 860-4233.

CIRCLE 187



ULTRA Precision Tooling
.00012" or less T.I.R. guaranteed for Hydraulic Chucks shown in this new Schunk catalog. Schunk High Precision tooling is used in demanding gear manufacturing and testing applications. Other applications include cutting tool manufacturing and resharpening, precision mil-ling and boring where tool life, finish and productivity cannot be compromised. For more information or to receive a free catalog, call 1-800-772-4865.

CIRCLE 188

<http://www.geartechology.com>
A WHOLE NEW WORLD OF GEARING

Hyperlink to Cool Sites!
 Send E-Mail!
 Play in the InfoRoad!

A VISITOR'S GUIDE



Directory of
 Buyers & Sellers
 of Important
 Gear Stuff

Semi-Regular
 Updates:
 See Changes
 Since Your
 Last Visit

Gear Schools,
 Professional
 Societies,
 Cool Research
 Sites



THE ONLINE VERSION —

- See:
 - Current Issue Summary
 - Coming Attractions
 - Technical Calendar —
 Updates Between Print Issues.
 - Expanded Addendum —
 Even more gear trivia and weirdness than the print version!
- E-mail the staff.
- Get advertiser info.
- Subscribe online

Steel Mill Gearing Symposium

November 13 and 14, 1996
 Pittsburgh, Pennsylvania

Standards: AGMA, ISO

Gear Set Design/Optimum Tooth Profile

Metallurgy

Lubrication

Torsional Vibration/Torque Amplification

Comprehensive System Concept

Maintenance

Specifications

For information contact

EDUCATIONAL SYSTEMS WORKSHOPS
 P.O. Box 472
 Dyer, IN 46311
 Telephone 412-776-5745 or 219-865-1318
 Fax 412-776-5749 or 219-865-2775

CIRCLE 149 or call 1-800-340-1160 x9149

Double-Flank Gear Roller System

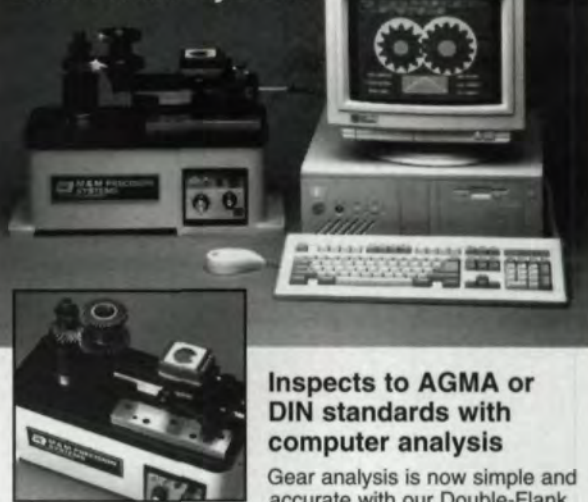

Inspects to AGMA or
 DIN standards with
 computer analysis

Gear analysis is now simple and
 accurate with our Double-Flank

Gear Roller and IBM compatible software. Inset shows Master
 Gear rolling with helical parallel axis component.

- Perform total composite, tooth-to-tooth, nick,
 and runout analysis.
 - Display component tolerances and analysis results.
 - Computer indicates out-of-spec values.
 - Analysis with AGMA or DIN Standard.
- For FREE brochure, circle reader service number.
 For FAST action, call 513/859-8273 or FAX 513/859-4452.

M&M PRECISION
SYSTEMS CORPORATION
 AN ACME-CLEVELAND COMPANY

CIRCLE 163 or call 1-800-340-1160 x9163



Innovation...

AMS-250-1AL CNC Analytical Gear Tester

The world's most advanced gear metrology system

The Innovation...

This Premium Grade CNC Gear Tester incorporates revolutionary design features which were not possible just a few years ago. Using the latest technology, our product design team has built the most advanced CNC Gear Tester available in today's market. And they've made the AMS-250 affordable at the same time! The combination of advanced technology and off-the-shelf components makes the AMS-250 a respected, high-performance, economical instrument for Gear Metrology.



Advanced Features...

- Modular no-wear design
- Aerostatic bearing - provides non-contact motion of all axes
- Linear motor drives
- Ultra-high resolution -
Linear = 0.01 microns
Rotary = 0.045 arc seconds
- WinSpect Platform
- Intel® PC electronics
- Advanced test data collection, evaluation, analysis, and post-process management
- Available in High-Accuracy & Standard-Accuracy grades

WinSpect™ Platform ...



A powerful and friendly tool! This application guides operator part setup and test sequencing to automatically evaluate gear test results, then quickly produces an analysis using AGMA, DIN, ISO, or user specified tolerances. Combine this with the unrivaled flexibility of the Microsoft® Windows™ Operating System and you have a simple means for data collection, analysis, and post-process management of critical gear test results. Results never before achievable!

CIRCLE 109 or call 1-800-340-1160 x9109

Questions? We are at your service! Our proven technical staff with 175+ years of gear technology experience will help you find solutions and learn more about this remarkable instrument. For prompt assistance, call or FAX our WinSpect Product Team at:

American Sykes Company

Solutions for the Gear Manufacturer

1302 Research Park Drive

Beavercreek, OH 45432

Tel 513-427-0507 • FAX 513-427-9653

A member of the
David Brown Group



Gear Wear Caused By Contaminated Oils

Douglas Godfrey

Introduction

The diagnosis and prevention of gear tooth and bearing wear requires the discovery and understanding of the particular mechanism of wear, which in turn indicates the best method of prevention. Because a gearbox is a tribologically dependent mechanism, some understanding of gear and bearing tribology is essential for this process. **Tribology** is the general term for the study and practice of lubrication, friction and wear. If tribology is neglected or considered insignificant, poor reliability and short life will result.

One of the most common causes of practical industrial wear problems is contaminants in the oil. In this article the author shares his experience with the diagnosis and solution of such problems and their relationship to basic tribology.

Kinds of Lubrication

Occurring in a Gearbox

All types of gears and their support bearings utilize the three kinds of lubrication.

Hydrodynamic Lubrication (HDL) exists when a gas or liquid film completely separates moving surfaces, preventing solid-to-solid contact. HDL is the most desirable regime of lubrication because friction is low and wear can be extremely low. In gears it occurs whenever the sliding of engaging teeth, especially just above or below the pitch line, allows for the formation of a wedge of oil that can completely separate the teeth. Journal bearings in the gearbox also operate in the HDL regime.

The primary HDL property of the oil is its viscosity. The oil film thickness must be greater than the sum of the surface roughnesses to minimize wear. A rule of thumb to apply here is that the oil film thickness is proportional to the square root of the viscosity. For example, if gear oil viscosity is increased from

ISO 150 to ISO 320, film thickness will be increased 46% for a given load and sliding speed. It is important to note that in spur gears, HDL is discouraged by the automatic reversal of sliding direction on the addendum and dedendum.

Elastohydrodynamic Lubrication (EHL) implies that a full oil film is formed between moving surfaces that are elastically deformed. It occurs in concentrated contacts, such as rolling contact at the pitch line of the gears. The metals at the line of contact deform elastically, and the oil trapped between them is subjected to extremely high Hertzian pressures. The oil viscosity increases with high pressures by many orders of magnitude. For example, a mineral oil with a viscosity of 15 cSt at atmosphere pressure would be 100,000 cSt at 140,000 psi. The oil may be considered a solid for the short time it is at that pressure. The pressure-viscosity coefficient is a measure of change.

As a result of combined elastic deformation and high viscosity, an extremely thin film of oil completely separates the surfaces and prevents metal-to-metal contact. EHL also occurs between the rolling elements of rolling element bearings and their raceways. For EHL, oil viscosity at atmospheric pressures is still important for dragging the oil into the contact.

The EHL theory was developed by English tribologists Dowsen and Higgen- sen in order to understand zero tooth wear on a 30-year-old operating gearbox. They developed an equation for the calculation of minimum oil film thickness of engaging gear teeth (See Table 1).

Boundary Lubrication (BL) occurs when HDL and EHL fail, and metal-to-metal contact occurs, such as when the tip of a spur gear tooth slides near the root of the opposing tooth. BL also occurs during

Table 1 — Equation for the Calculation of Minimum Film Thickness in the Elastohydrodynamic Lubrication Regime.*

$$h_{min} = \frac{1.63\alpha^{0.54}(\mu_0 V_e)^{0.7} \rho n^{0.43}}{(X_r W_{Nr})^{0.3} E_r^{0.13}}$$

The specific film thickness is given by

$$\lambda = \frac{h_{min}}{\sigma}$$

where

σ = composite surface roughness

$$\sigma = (\sigma_1^2 + \sigma_2^2)^{1/2}$$

σ_1, σ_2 = surface roughness, rms (pinion, gear)

μ_0 = absolute viscosity, Reysn (lb sec/in²)

α = pressure-viscosity coefficient, (in²/lb). The pressure-viscosity coefficient ranges from $\alpha=0.5 \times 10^{-4}$ to $\alpha=2 \times 10^{-4}$ for typical gear lubricants.

E_r = reduced modulus of elasticity given by

$$E_r = 2 \left(\frac{1 - \nu_1^2}{E_1} + \frac{1 - \nu_2^2}{E_2} \right)^{-1}$$

where

ν_1, ν_2 = Poisson's ratio (pinion, gear)

E_1, E_2 = modulus of elasticity (pinion, gear)

ρn = normal relative radius of curvature

$$\rho n = \frac{\rho_1 \rho_2}{(\rho_2 \pm \rho_1) \cos \Psi_b}$$

ρ_1, ρ_2 = transverse radius of curvature (pinion, gear)

Ψ_b = base helix angle

V_e = entraining velocity given by

$$V_e = V_{r1} + V_{r2}$$

where

V_{r1}, V_{r2} = rolling velocities given by

$$V_{r1} = \omega_1 \rho_1$$

$$V_{r2} = \omega_2 \rho_2$$

ω_1, ω_2 = angular velocities (pinion, gear)

W_{Nr} = normal unit load given by

$$W_{Nr} = \frac{W_{Nr}}{L_{min}}$$

where

W_{Nr} = normal operating load

L_{min} = minimum contact length

* These equations are taken from Reference 2, Errichello, "Lubrication of Gears."

start-up, shut down, at high loads and high temperatures and in worm gears. The important oil property for BL is the soluble anti-wear and anti-scuff additives in the oil, which react with the metal surfaces to form a thin, tough film that reduces metal-to-metal contact.

In worm gears, which resemble a screw thread with continuous sliding, lubricity additives are required to reduce friction. Lubricity is defined as that property of a lubricant that reduces friction.

Oil with good lubricity also improves gearbox efficiency.

Mixed Lubrication. HDL, EHL and BL may not occur ideally and isolated in gears, but in a mixed condition. During one tooth engagement all three lubrication mechanisms may occur consecutively or simultaneously. Unfortunately, ideal lubrication mechanisms frequently fail and allow high wear.

Many articles such as Refs. 1 and 2 provide information on gear lubrication.



A CUT ABOVE THE REST

Amarillo Gear Company combines years of experience with quality materials and workmanship to create spiral bevel gears that are a cut above the field.

Amarillo builds high quality spiral bevel gears up to 100 inches in diameter for industries across the globe. Each set is manufactured for quiet operation and durability to suit the exact production requirements of our customers.

Contact Amarillo Gear about your custom application. You'll find a ready ear and a quick response to your needs.



Amarillo Gear Company

P.O. Box 1789 Amarillo, Texas 79105 (806) 622-1273
TWX 910-898-4128/Amadrive FAX (806) 622-3258



You can count on it.

© AGC 1995

Kinds of Gear Wear

The AGMA booklet (Ref. 3) and other literature describe the numerous kinds of gear tooth failures. Table 2 shows a list of the most common wear mechanisms related to contaminated lubricants.

Table 2 — Common Kinds of Gear and Bearing Wear

Gears	Abrasion Scuffing Contact Fatigue and Spalling Polishing Wear Pitting
Bearings	Rolling Element Nicks and Dents Contact Fatigue Abrasion Fretting Corrosion
Journal	Wiping of Babbitt Excessive Embedment

Wear Caused by Contaminated Gear Oil

In the author's experience, contamination of the lubricant accounts for about 80% of gear tooth wear and bearing distress. *Therefore for reliability and long life, keep the oil clean and dry.* Contaminants in lubricated machines may come from the fresh oil or the new machine, be generated by the system while running or ingested from external sources. These issues are discussed in detail in Ref. 4.

Following are the major kinds of oil contamination and the types of gear tooth and bearing wear they cause.

- Ingested dirt
 - Any solids interfere with oil film formation.
 - Hard particles cause abrasion.
 - Fine particles cause polishing wear.
 - Dirt makes dents in rolling element bearings, leading to fatigue failure.
- Water
 - Interferes with oil film formation.
 - Causes rust.
 - Degrades the oil by acting as a catalyst for oxidation.
- Manufacturing debris
 - Same as ingested dirt, plus metal chips bridge the oil film and initiate scuffing.
- Chemicals
 - Cause corrosion and oil degradation.
- Wear debris
 - The accumulation of gear wear debris promotes oil degradation.

CIRCLE 151 or call 1-800-340-1160 x9151

- Wear debris embeds in babbitt bearings and destroys the surface.
- Wrong oil
 - If viscosity is too low, oil film is too thin.
 - If viscosity is too high, gearbox efficiency decreases.
 - If additives are too chemically active, corrosion and polishing wear result.
 - If additives are not chemically active enough, the risk of scuffing increases.

Abrasion

Hard particles in the oil are the most frequent cause of gear tooth wear. Abrasion is the cutting of metal by hard particles or a rough surface. Abrasion is readily recognized by parallel furrows in the direction of sliding. If the abrasion is caused by hard particles, such as sand or grinding grit in the oil, it is called three-body abrasion. Prevention is obvious—remove the hard particles. If abrasion is caused by one tooth cutting the opposing one, such as when a hard, sharp gear tooth tip slides against a softer root, two-body abrasion occurs. The result is the same as filing. Smoother surfaces and chamfered tips will prevent this type of abrasion.

Rolling element support bearings suffer when solid particles and water contaminate the oil. The hard particles cause nicks and dents on the raceway and the rolling elements and abrade the sliding areas, such as between the cage and the rolling element bearings. The dents shorten life and start contact fatigue failure. Water in the oil accelerates crack growth, thus shortening fatigue life. Ideally, the rolling element bearings would be less stressed if they had their own clean and separate oil supply and didn't have to run on the oil contaminated with gear wear particles.

Other well-known tribology problems are caused by improper metallurgy, excessive loads, speeds and temperatures and misalignment.

Detection of Contaminated Gear Oil

The degree of contamination and the type of contaminants are usually determined by an oil analysis laboratory. However, a rough idea of contamination can be obtained on site using a simple process.

Collect some oil in a clean, tall, narrow glass bottle, (a 2-oz. olive bottle is about right). Look at the oil with a bright light. If it is hazy, it is probably contaminated with water. Smell the oil. If it has a bad odor compared to fresh oil, it is probably oxidized. Now set the bottle aside for at least two days and allow the dense contaminants to settle; then examine the material in the bottom. Metal wear fragments will be present and if ferrous, they will move with a magnet. Water will be a clear layer; sand and clay will also be on the bottom, but will not move with a magnet. To get a better look, carefully pour off most of the oil above the contaminants, add clean paint thin-

ner, shake up and allow the contaminants to settle again. Any visible magnetic fragments, sand or water is bad news.

Reducing Contamination

Contamination can be reduced and oil cleaned by following some simple procedures.

- Change used oil frequently.
- Filter oil with a circulating system with a full-flow, 3-micron filter and reduce ingestion of dirt and water by means of a fine air filter on the vent or breather tube.
- Before operating a new gearbox, clean the gears and gearboxes of all manufacturing debris by vigorous flushing. Grinding and cutting chips, welding splatter, sand from sand blasting, steel shot,

BUILDING ON EXCELLENCE...

Quality Is A Constant
Introducing two new products that will enhance your production capabilities and improve product delivery.

NEW



CNC Grinders (Vertical)

NEW U-Axis



U-Axis Machining Centers (Horizontal and Vertical)

NEW



CNC Gear Hobbers and Hob Sharpeners



CNC Turning/Mill - Turn Center

IKEGAI

IKEGAI AMERICA CORPORATION
2246 North Palmer Drive, Suite 108
Schaumburg, Illinois 60173
TEL (847) 397-3970 FAX (847) 397-7535

Dealers Inquiries Welcome
COME SEE US AT IMTS BOOTH #D2-4385.

CIRCLE 124 or call 1-800-340-1160 x9124

Table 4 — Common Wear Problems Related to Lubricants & Hydraulic Fluids*

Names of Wear		Definition	Susceptible Machine Parts	Conditions Promoting Wear	Unaided Eye
	Other				
Mild Adhesion	Normal ^a	Generally, transference of material from one surface to another due to adhesion and subsequent loosening during relative motion. Mild adhesion involves transfer and loosening of surface films only.	All.	<ul style="list-style-type: none"> Moderate loads, speeds & temperatures. Good, clean, dry lubricants. Proper surface finish. 	<ul style="list-style-type: none"> Low rates of wear. No damage. Deeper original grinding marks still visible.
Severe Adhesion	<ul style="list-style-type: none"> Scuffing Galling Scoring^b 	Cold welding of metal surfaces due to intimate metal-to-metal contact.	<ul style="list-style-type: none"> Piston rings and cylinder barrels. Valve train. Rolling & sliding bearings. Gears. Cutting tools. Metal seals. Chains. 	<ul style="list-style-type: none"> High loads, speeds and/or temperatures. Use of stainless steels or aluminum. Insufficient lubricant. Lack of anticuff additives. No break in. Abrasive wear. 	<ul style="list-style-type: none"> Rough, torn, melted or plastically deformed metal, broad or streaks. High temperature oxidation. High friction, high rates of wear. Possible seizure.
Abrasion ^c	<ul style="list-style-type: none"> Cutting Scratching "Wire Wool" damage Gouging Scoring 	Cutting and deformation of material by hard particles (3-body) or hard protuberances (2-body).	All surfaces in relative motion.	<ul style="list-style-type: none"> Hard particles contaminating oil. Insufficient metal hardness. Hard metal with rough surface against soft metal. 	<ul style="list-style-type: none"> Scratches or parallel furrows in the direction of motion, similar to "sanding." High rates of wear.
Erosion	<ul style="list-style-type: none"> Solid Particles Impact Erosion 	Cutting of materials by hard particles in a high-velocity fluid impinging on a surface.	<ul style="list-style-type: none"> Journal bearings near oil holes. Valves. Nozzles. 	<ul style="list-style-type: none"> High-velocity gas or liquid containing solids impinging on a surface⁹. 	<ul style="list-style-type: none"> Smooth, broad grooves in direction of fluid flow. Matte texture, clean metal. Similar to sandblasting.
Polishing	Bore Polishing	Continuous removal of surface films by very fine abrasives.	<ul style="list-style-type: none"> Cylinder bores of diesel engines. Gear teeth. Valve lifters. 	<ul style="list-style-type: none"> Combination of corrosive liquid and fine abrasive in oil¹¹. 	<ul style="list-style-type: none"> High wear, but a bright mirror finish. Wavy profile.
Contact Fatigue	<ul style="list-style-type: none"> Fatigue Wear Frosting Surface Fatigue Spalling 	Metal removal by cracking and pitting due to cyclic elastic stress during rolling and sliding.	<ul style="list-style-type: none"> Rolling & sliding bearings. Valve train parts. Gears. 	<ul style="list-style-type: none"> Cyclic stress over long periods. Water, dirt in oil. Inclusions in steel. 	Cracks, pits and spalls.
Corrosion	<ul style="list-style-type: none"> Chemical Wear Oxidative Wear Corrosive Film Wear 	Rubbing off of corrosion products on a surface.	<ul style="list-style-type: none"> All bearings. Cylinder walls. Valve train. Gears. Seals and chains. 	<ul style="list-style-type: none"> Corrosive environment. Corrodible metals. Rust-promoting conditions¹. High temperatures. 	Corroded metal surface.
Fretting Corrosion	<ul style="list-style-type: none"> False Brinelling Fretting Friction Oxidation 	Wear between two solid surfaces experiencing oscillatory relative motion of low amplitude.	<ul style="list-style-type: none"> Vibrating machines. Bearing housing contacts. Splines, keys, couplings. Fasteners. 	Vibration-causing relative motion.	<ul style="list-style-type: none"> Corroded, stained surfaces⁸. Loose colored debris around real contact areas. Rouge (Fe₂O₃) colored films, debris, grease or oil for steel.
Electrocorrosion	<ul style="list-style-type: none"> "Erosion" Electrical Erosion Electrochemical Wear Electrical Attack 	Dissolution of a metal in an electrically conductive liquid by low amperage currents.	<ul style="list-style-type: none"> Aircraft hydraulic valves. Hydraulic pumps and motors. 	<ul style="list-style-type: none"> High-velocity liquid flow causing streaming potentials. Stray currents. Galvanic metal combinations. 	<ul style="list-style-type: none"> Local corroded areas. Black spots such as made by a small drop of acid. Corroded, worn metering edges.
Electrical Discharge	<ul style="list-style-type: none"> Electrical Pitting Sparking 	Removal of metal by high amperage electrical discharge or spark between two surfaces.	<ul style="list-style-type: none"> Bearings in high-speed rotating machinery, such as compressors, atomizers. Static charge producers. 	<ul style="list-style-type: none"> High-speed rotation. High-velocity, two-phase fluid mixtures. High potential contacts. Sparks. 	Metal surface appears etched. In thrust bearings, sparks make tracks like an electrical engraver.
Cavitation Damage ^m	<ul style="list-style-type: none"> Cavitation Erosion Fluid Erosion 	Removal of metal by bubble implosion in a cavitating liquid.	<ul style="list-style-type: none"> Hydraulic parts, pumps, valves, gear teeth. Cylinder liners, piston rings. Sliding bearings. 	Sudden changes in liquid pressure due to changes in liquid velocity or to shape or motion of parts ¹¹ .	<ul style="list-style-type: none"> Clean frosted or rough-appearing metal. Deep rough pits or grooves.

* From "Recognition and Solution of Some Common Wear Problems Related to Lubricants & Hydraulic Fluids," *Lubrication Engineering*, February, 1987. Reprinted with permission.

Symptoms Microscopically	Oil Analysis	Prevention	
		Mechanical Changes	Lubricant Changes
<ul style="list-style-type: none"> • Smooth microplateaus among original grinding marks. • Slight coloration due to films. 	<ul style="list-style-type: none"> • 1-5 ppm wear metals by emission spectroscopy. • Low % solids by filtration. • Metal salts (oxides, sulfides, phosphates, etc.) in wear fragments by X-ray diffraction. 	None.	None.
<ul style="list-style-type: none"> • Rough irregular surface. • Metal from one surface adhering to other surface by spot tests or microprobe analysis. 	Large metallic wear fragments of irregular shape ^c .	<ul style="list-style-type: none"> • Reduce load, speed and temperature. • Improve oil cooling. • Use compatible metals. • Apply surface coatings such as phosphating. • Modify surface, such as ion implantation^d. 	<ul style="list-style-type: none"> • Use more viscous oil to separate surfaces. • Use "extreme pressure" additives, such as a sulfur-phosphorous or borate compound.
<ul style="list-style-type: none"> • Clean furrows, burrs, chips. • Embedded abrasive particles. • In sliding bearings with soft overlay, embedded particles cause polished rings. 	<ul style="list-style-type: none"> • High metal content in oil and high silicon (>10 ppm) by emission spectroscopy. • High % solids by filtration. • Chips and burrs by ferrometry. 	<ul style="list-style-type: none"> • Remove abrasive by improved air and oil filtering, clean oil handling practices, improved seals, flushing and frequent oil changes^f. • Increase hardness of metal surfaces. 	<ul style="list-style-type: none"> • Use oil free of abrasive particles. • Use more viscous oil.
<ul style="list-style-type: none"> • Short V-shaped furrows by scanning electron microscopy. • Embedded hard particles. 	Elements of hard particles by emission spectroscopy. Chips and burrs by ferrometry.	<ul style="list-style-type: none"> • Same as above. • Reduce impact angle to less than 15°. 	Same as above.
Featureless surface except scratches at high magnification by electron microscopy.	Combination of fine metal corrosion products and fine abrasive by X-ray diffraction.	None.	<ul style="list-style-type: none"> • Choose less chemically active additive. • Remove corrosive contaminant. • Remove abrasive.
<ul style="list-style-type: none"> • Combination of cracks and pits with sharp edges. • Subsurface cracks by metallographic cross section. Numerous metal inclusions. 	<ul style="list-style-type: none"> • Particles of metal with sharp edges. • Metal spheres by electron microscopy. 	<ul style="list-style-type: none"> • Reduce contact pressures and frequency of cyclic stress. • Use high quality vacuum melted steels. • Use less abusive surface finish. 	<ul style="list-style-type: none"> • Use clean, dry oil. • Use more viscous oil. • Use oil with higher pressure viscosity coefficient^h.
Scale, film, pits containing corrosion products. Dissolution of one phase in a 2-phase alloy.	<ul style="list-style-type: none"> • Detection of corrosion products of worn metal. • Detection of anions, such as chlorine, by X-ray fluorescence. 	<ul style="list-style-type: none"> • Use more corrosion resistant metal (not stainless). • Reduce operating temperature. • Eliminate corrosive material. 	<ul style="list-style-type: none"> • Remove corrosive material such as too chemically active additives and contaminants. • Use improved corrosion inhibitor. • Use fresh oil.
Thick films of oxide of metal. Red and black for steel.	Identify metal oxide (\approx Fe ₂ O ₃ for steel) by X-ray diffraction.	<ul style="list-style-type: none"> • Reduce or stop vibration by tighter fit or higher load. • Improve lubrication between surfaces by rougher (then honed) surface finish. 	<ul style="list-style-type: none"> • Use oil of lower viscosity. • Relubricate frequently. • Use oxidation inhibitors in oil.
Corrosion pits, films, dissolution of metals.	<ul style="list-style-type: none"> • Detection of corrosion products. • Electrically conductive liquidsⁱ. 	<ul style="list-style-type: none"> • Decrease liquid velocity and velocity gradients. • Use corrosion-resistant metals. • Eliminate stray currents. • Use nongalvanic couples. 	Decrease or increase electrical conductivity of lubricants of hydraulic fluids.
<ul style="list-style-type: none"> • Pits near edge of damage, showing once molten state, such as smooth bottoms, rounded particles, gas holes. • Rounded particles near pits welded to surface. 	Detection of large rounded particles by microscopic examination of filtrate or in ferrometry.	<ul style="list-style-type: none"> • Improve electrical insulation of bearings. • Degauss magnetic rotating parts. • Install brushes on shaft. • Improve machine grinding. 	Use oil of higher electrical conductivity.
<ul style="list-style-type: none"> • Clean, metallic bright rough metal, pits. • Removal of softer phase from 2-phase metal^o. 	Observation of large chunks or spheres of metals in oils.	<ul style="list-style-type: none"> • Use hard tough metals, such as tool steel. • Reduce vibration, flow velocities and pressures. • Avoid restrictions and obstructions to liquid flow. 	<ul style="list-style-type: none"> • Avoid low vapor pressure, aerated, wet oils. • Use noncorrosive oils.

grinding grit, such as silicon carbide, paint chips and fibers are all frequently found in new gearboxes.

- Clean and assemble gearboxes in a dedicated clean room, not a dusty shop.
- Filter fresh oil as it is added to a gearbox.

This kind of simple, basic practice should greatly reduce the risk of lubricant contamination and consequent gear wear and failure.

References:

1. Radovich, J.L. "Gears," *The Handbook of Lubrication, Theory and Practice of Tribology, Vol. 2, Theory and Design*. E. Richard Booser, ed. CRC Press, Boca Raton, FL, 1984, pp. 539-564.
2. Errichello, R. "Lubrication of Gears, Parts 1-4," *Lubrication Engineering*, 46, Jan, pp. 11-13, Feb, pp. 117-121, Mar, pp. 181-185, Apr, pp. 230-237, 1990 or *Gear Technology*, Vol. 8, Nos. 2, 3, 4, 1991, Mar/Apr, pp. 18-26, May/June, pp. 18-22, July/Aug, 14-22.
3. *Standard Nomenclature of Gear Tooth Failure Modes*. American Gear Manufacturers Association, Arlington, VA, ANSI/AGMA 110.04, Aug, 1980.
4. Godfrey, D. "Clean, Dry Oil Prolongs Life of Lubricated Machines," *Lubrication Engineering*, 45, Jan, 1989, pp. 4-8.

Douglas Godfrey is the principal in *Wear Analysis*, a tribology consulting firm in San Rafael, CA. He has over 50 years' experience in tribology research and study and is a well-known author and lecturer in the field.

Notes for Table 4

- a — Mild adhesion is a desirable wear condition.
- b — Scoring is not recommended because it implies a scratch or furrow cut by abrasion.
- c — Emission spectroscopy usually misses large (> 5 micron) wear fragments.
- d — Increasing metal hardness does not reduce scuffing.
- e — The most common wear problem.
- f — Do not shot peen, bead or sandblast any surface in a lubricated machine because abrasive cannot readily be removed completely.
- g — Sandblasting embeds sand in surfaces.
- h — An example of polishing combination in oil is active sulfur additive and Fe₂O₃ (jeweler's rouge).
- i — A new additive reduces promotion of contact fatigue by water; some extreme pressure additives are suspected of promoting contact fatigue.
- j — Rust (hydrated iron oxide Fe₂O₃·H₂O) is common corrosion product of ferrous metal.
- k — Damage on one surface is mirror image of damage on other.
- l — Highly compounded oils can be electrically conductive—or electrolytes; phosphate ester hydraulic fluids are conductive.
- m — Not to be confused with pump cavitation, which is a different phenomenon.
- n — Corrosion and abrasive in oil increase cavitation damage.
- o — Graphite phase in cast iron susceptible to removal by cavitation.

Tell Us What You Think...

If you found this article of interest and/or useful, please **circle 214**.

For more information about Wear Analysis, please **circle 215**.

Saikuni

Spiral Cutter Sharpening Machine NCG-125-205

Advanced, Fully Automatic, Multi-Purpose,
5-Axis CNC Grinding Machine

- Full automatic cycle with automatic cutter positioning device
- Power clamping for easy load/unload
- Easy setup minimizes downtime
- Also sharpens coniflex, helical pinion and revacycle cutters

Ataka Group
Ataka Machinery Co., Ltd.
Ataka Engineering Co., Ltd.
Phone (81)-52-772-0690
Fax (81)-52-772-0692
e-mail: ataka@mx.meshnet.or.jp



CIRCLE 148



We want to work with you!

Roto-Check your GEARS using ROTO-SMART TECHNOLOGY CNC
Automatic Inspection Systems-the RC 400!

- Gears
- Splines
- Hobs
- Shaper Cutters
- Camshafts
- Worm Sets
- Crankshafts
- and more



The field-tested, PC user-friendly RC-400, has quality, accuracy, small footprint, 360° rotational probe, and is affordable.

Basic package inspects space, lead and involute. Many software options are available as well as custom-designed packages.

Free Video Available

Roto Technology, Inc.

351 Fame Road, Dayton, OH 45449-2388
TEL: (513) 859-8503, FAX: (513) 865-0656
www.rototech.com

CIRCLE 118 or call 1-800-340-1160 x9118

PRODUCT NEWS

Welcome to our Product News page. Here we feature new products of interest to the gear and gear products markets. To get more information on these items, please circle the Reader Service Number shown. Send your new product releases to: *Gear Technology*, 1401 Lunt Avenue, Elk Grove Village, IL 60007, Fax: 847-437-6618.

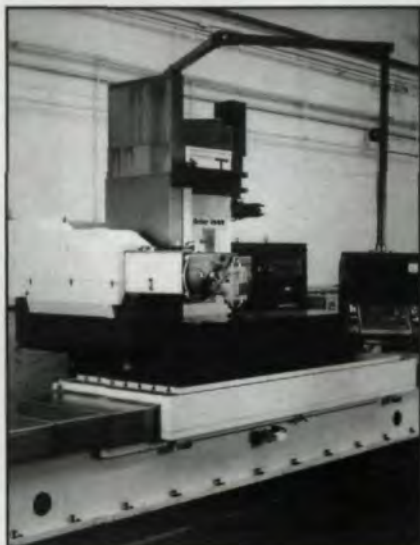

Holroyd TG350E Thread Grinder

This new model is able to grind a range of helical forms from one-off prototypes to high-volume production and allows fast and efficient changeover between jobs. It features touch-screen menu controls, profile management software, which ensures consistent accurate profile grinding to microns, and a 4-axis CNC wheel profiling dressing unit. It also has a workhead with hydrostatic bearings, a high-resolution AC digital servo system, hydrostatic ways, a 45kW grinding spindle motor and digital scanning probes for "in process" measurement during production or setup.

Circle No. 300

Tribology Tool

Computational Systems Inc., offers a new maintenance tool, the OilView 51DV Digital Viscometer. It provides on-site measurements of viscosity, the primary indicator of a fluid's lubricating property. The 51DV detects misapplication of lubricants, including wrong or mixed oils; detects fuel dilution in liquid-fueled engine applications and establishes lubricant viscosity for trending.

Circle 301



Electric Surface Finisher

C. S. Unitec introduces a new way to sand and polish stainless steel, aluminum and other metals. Their variable speed, electric surface finisher features a rubber air-roller with an inflatable cushion, which adapts itself to the curvature of the workpiece for uniform, shadow-free finishing of flat surfaces and contours. Has an 11 amp motor and speed selections from 1,200 to 3,700 rpm, making it ideal for polishing, smoothing, dulling, graining, brushing and deburring. It can produce up to No. 4 and No. 8 Mill finishes.

Circle 302

Chemical Deburring Process

Surface Technology, Inc. announces the availability of DEBURR 1000, a process for deburring most types of steel. This electroless chemical process removes burrs on steel parts resulting from cutting, milling, forging and molding without distorting even the most intricately shaped parts. It is environmentally friendly and leaves parts clean and suitable for immediate use or subsequent surface finishing.

Circle 303

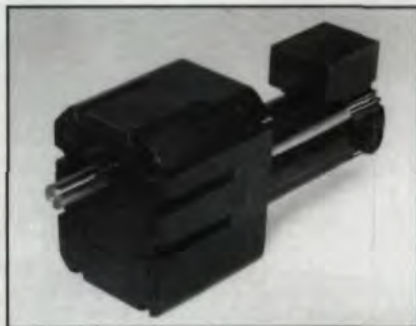

Improved High-Torque Gearmotors

Bison Gear announces an enhanced version of its new Series 650 parallel shaft gearmotors. This series has a gearbox measuring only 5" x 6.25" x 5.75", yet they deliver torques up to 720 in-lbs. They will now withstand occasional peaks up to 250% of their full-load torque. Gear ratio ranges are from 11:1 to 2206:1 and speeds range from 0.7 to 16 rpm. The units are lifetime oil lubricated and sealed with gaskets and O-rings. The gearmotors are available in 1/20, 1/6 or 1/2 hp and in 2-, 3-, 4- and 5-stage versions.

Circle 304



Portable CMMs

Weighing only 14 lbs, the new Romer 1000 series articulating arm CMMs are completely portable. The arm and its components are contained in a single suitcase, and setup takes less than five minutes. The arm is mountable in any orientation, even upside down. Arm lengths range from a 4-ft. to a 10-ft. diameter measuring envelope.

Measurement options extend its reach to 32 feet with no loss of accuracy. The system comes with a color notebook computer and software featuring graphic representation and on-screen relational storage of measured or theoretical geometric features. It interfaces to other popular CMM and engineering software and is Windows® 95-compatible.

Circle 305

New Preservatives

Esgard, Inc. introduces the "P" preservatives. These coatings are used in preservation and packaging of metal items such as gears, turbines, engines, automotive parts, lubrication systems, steam components and fill and drain voids. They are qualified per MIL-C-16173E. All are VOC-compliant, easy to remove and safe.

Circle 306



Collimating Magnifiers

GEI International introduces the ONS-0180 series of collimating magnifiers specifically designed to eliminate parallax errors when viewing objects. They are available with magnifying powers of 7x and 10x, and they feature flat-field, achromatic, color-corrected lenses, which provide distortion-free viewing. Applications include scientific measurement using meters, scales, thermometers, etc., and most inspection operations involving the visual measurement of an object. May be used in normal room light or on a light table or box.

Circle 307

**TURN YOUR
"RED LINER"
AROUND**

WITH OUR COMPOSITE
GEAR
ANALYZER®



ANALYZED RESULTS:

- TOTAL COMPOSITE VARIATION
- MAXIMUM TOOTH TO TOOTH COMPOSITE VARIATION
- TEST RADIUS
- RUNOUT

YOUR **RED LINER** NEVER
TOLD YOU THE COMPLETE STORY
NOW YOU WILL GET EVERY
DETAIL.

PC-20 CGA®

A Proven Design with Today's
Technology



PROFILE ENGINEERING INC.
100 River Street
Springfield, VT 05156
802-885-9176
Fax 802-885-6559



Internal/External Grinders

The **NOVAMATIC** internal grinder series handles parts with ODs from 10 to 200 mm, while the **NOVAMATIC** external grinder series has an OD range from 10 to 350 mm. These machines from **Meccanica Nova** offer straight/spherical grinding through interpolation, quick changeover tooling, total machine accessibility for easy maintenance, machine enclosures to EEC standards for environment protection, CNC

CIRCLE 133 or call 1-800-340-1160 x9133

or PLC controls, U.S. electricians, in-process/post-process gaging, part handling automation and multiple workholding/wheel dressing methods.

Circle 308

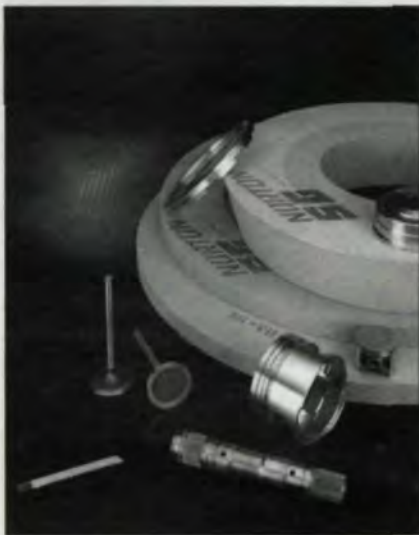

New Ceramic Abrasives

The Norton Co. announces its new Targa-VH Bond product line of advanced ceramic abrasives for demanding grinding jobs, particularly in cylindrical and plunge centerless grinding. The products are available in two concentrations: 50% (5TG) for difficult-to-grind materials, small contact areas and heavy stock removal, and 30% (3TG) for easy-to-grind materials, large contact areas and light stock removal. Grit sizes are 80/3, 80/4, 120/3 and 120/4. Wheel dimensions include >16-24" OD up to 6" thick, >24-36" OD up to 4" thick and >36-42" OD up to 3" thick.

Circle 309

New Gaging Technology

KMS Industries introduces new optical technology for gaging the contour of a surface. This technology can generate up to one million data points within one second to micrometer resolution. It measures absorbed light and can operate in the manufacturing environment because it is relatively insensitive to vibration, dust and ambient temperature.

Circle 310

New Design of Fine Grinding Machines

The MicroLine AC-1200, AC-1500 and AC-2000 machines from Peter Wolters of America are designed for double-side, fine grinding, lapping and polishing applications. They feature a new sliding head with a fixed spindle for superior upper wheel rigidity with increased horsepower. They also have a

newly designed, enhanced pressure control system for more predictable consistency in output quality, lower overall machine height, AC servo motors to interface with automation and built-in diagnostics.

Circle 311

Tell Us What You Think...

If you found this article of interest and/or useful, please circle 216.

NEW! NOW YOU HAVE ANOTHER CHOICE...
and it's made in AMERICA!



A/W Systems Co. announces that it is now a manufacturing source of spiral gear roughing and finishing cutters and bodies.

We also can manufacture *new* spiral cutter bodies in diameters of 5" through 12" at present.

A/W can also supply roughing and finishing cutters, hardware and replacement parts for most 5"-12" diameter bodies.

Whether it's service or manufacturing, consider us as an alternative source for replacement parts and hardware as well as bodies and cutters.

You'll be in for a pleasant surprise.

NEW! Straight Bevel Cutters.



A/W Systems CO.

Royal Oak, Michigan 48067

Tel: (810) 544-3852 • Fax: (810) 544-3922

CIRCLE 105 or call 1-800-340-1160 x9105

CLASSIFIEDS

SERVICE

GEAR TOOTH GRINDING SERVICES

- Cost effective gear tooth grinding specialists
- Gear manufacturers are our only customers
- Prototype and production quantities
- Capacity to 27.5" P.D., 3.5 D. P.
- Able to match delivery to your requirements
- All service to AGMA standards with Certified Gear Inspection Equipment

PRO-GEAR COMPANY, INC.

23 Dick Road Depew, NY 14043
Phone (716) 684-3811
Fax (716) 684-7717

CIRCLE 180 on READER REPLY CARD

GEAR INSPECTION UPGRADE

If you are not using the latest IBM compatible "user-friendly" ROTO-SMART package for your gear testers, composite testers, lead testers, redliners, and other inspection systems, you need us!

With this service, which meets AGMA standards, you will have the latest in gear technology.

We can also supply a new RC-400 Gear Inspection System.

Call 1-800-875-ROTO
or Fax us at (513) 865-0656

ROTO-TECHNOLOGY, INC.
351 Fame Road, Dayton, OH

CIRCLE 182 on READER REPLY CARD

LeCOUNT EXPANDING MANDREL REPAIR

If your LeCOUNT Expanding Mandrels have been damaged or are not within your required specifications, return them to us. We will repair or replace them at a very reasonable cost.

LeCOUNT, Inc.
12 Dewitt Drive
White River Jct., VT 05001
Tel: (800) 642-6713
Fax: (802) 296-6843

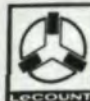

CIRCLE 176 on READER REPLY CARD

SERVICE

PFAUTER-MAAG CUTTING TOOLS LIMITED PARTNERSHIP

- HOB SHARPENING
- SHAVING CUTTER GRINDING
- TiN, TiCN, & TiAlN COATING SERVICES
- CUSTOM HEAT TREAT SERVICE

PFAUTER-MAAG CUTTING TOOLS
1351 Windsor Road, P.O. Box 2950
Loves Park, IL 61132-2950
Phone (815) 877-8900
Fax (815) 877-0264

CIRCLE 179 on READER REPLY CARD

INDEX PLATES

For
Grinding, Sharpening
& Inspection

- Complete Manufacture
- Meet or Exceed OEM's Spec.
- Sizes Ranging to 20 inch Dia.

MODIFIED GEAR & SPLINE, INC.
Serving the Gear Industry Since 1951

18300 MT. ELLIOTT
DETROIT, MI 48234
TEL: (313) 893-3511
FAX: (313) 893-6110

CIRCLE 178 on READER REPLY CARD

COMPUTER AIDS

GRAPHICAL GEAR DESIGN

- Generated Gears
- Tools and Tool Paths
- Non-Generated Gears
- Involute Splines, Racks
- Inspection Calculations
- Animated Meshing
- Form Calculations
- .DXF File Output



GearShop for Windows™

Because you asked for it!
800-437-2368

CIRCLE 184 on READER REPLY CARD

Rates—Line Classified: \$35 per line, 8 lines per inch, \$280 minimum. Classified Display (3" min.): 1X—\$565, 3X—\$530, 6X—\$500. Additional per inch: 1X—\$190, 3X—\$180, 6X—\$170. *Gear Technology* will set type to advertiser's layout or design a classified ad at no extra charge. **Payment:** Full payment must accompany classified ads. Send check or Visa/MasterCard/American Express number and expiration date to *Gear Technology*, P.O. Box 1426, Elk Grove Village, IL 60009. **Agency Commission:** No agency commission on classified ads. **Materials Deadline:** Ads must be received by the 25th of the month, two months prior to publication. **Acceptance:** Publisher reserves the right to accept or reject classified advertisements at his discretion.

HEAT TREATING

MERIT GEAR HEAT TREAT

810 HUDSON ST. ANTIGO, WI 54409

Induction Hardening
Tooth by Tooth NATCO
Carburizing
Carbonitriding
Stress Relieving
Normalizing
Annealing
Blasting & Straightening
Metallurgical Laboratory

1-800-75-MERIT
Fax: 715-627-2558

CIRCLE 177 on READER REPLY CARD

Contour Induction Hardening Specialists

Spur, helical and bevel gears

Our gear hardening equipment includes 3 NATCO submerged process machines and 4 AJAX CNC-controlled gear scanning machines. We can tool to meet any production need. Call for a company brochure.

American Metal Treating Company
1043 East 62nd Street
Cleveland, OH 44103
(216) 431-4492
Fax: (216) 431-1508

CIRCLE 174 on READER REPLY CARD

GEAR TOOLING

GEAR CUTTING TOOLS

"On the Shelf Inventory"

DIAMETRAL & MODULE
• HOBS
• SHAPER CUTTERS

1DP and finer
Made to AGMA standard

SPECIAL MADE TO ORDER TOOLS

• HOBS
• SHAPER CUTTERS
• SHAVING CUTTERS
• FORM RELIEVED INVOLUTE MILLING CUTTERS

BARIT INTERNATIONAL CORPORATION
3384 COMMERCIAL AVE.
NORTHBROOK, IL USA 60062-1909
TEL: 847-272-8128 FAX: 847-272-8210

CIRCLE 175 on READER REPLY CARD

GEAR MANUFACTURING

AIRCRAFT/AEROSPACE MACHINE TOOL

GEARS • SPLINES
SPUR • HELICAL
INTERNAL • EXTERNAL
TO 24" DIA.
OPEN RZ-300E TIME

CURVIC® COUPLINGS
TO 36" DIA. & 360 TEETH



ENGINEERING COMPANY
1840 AUSTIN, TROY, MI. 48083
PHONE 810-689-9700 • FAX 810-689-0281

CIRCLE 190 on READER REPLY CARD

PRECISION GEARS

Quality Service With Personal Attention
CNC GEAR SHAPING & HOBGING
CNC GEAR INSPECTION
HÖFLER ZEISS ZP250
SPC CAPABILITIES
MEDIUM TO FINE PITCH
SIZE RANGE 1/8" TO 10" DIAMETER

- Metric or American Std. • Spur & Helical
- Worms & Worm Gears • Serrations
- Splines, Internal & External • Sprockets
- Clusters • Sectors •

CLARKE GEAR CO.
aka Clarke Engineering Inc.
Established 1954
Phone (888) 277-GEAR (4327)
Fax (818) 767-5577
8058 Lankershim Blvd.
North Hollywood, CA 91605

CIRCLE 194 on READER REPLY CARD

To Advertise in the
Nov/Dec '96
Buyers Guide...



Duh!

Space aliens stopped at our editorial offices on their way to blowing up the White House and deliberately caused errors to appear in the Smith & Laskin article, "Noise Reduction in Plastic & Powder Metal Gear Sets." We regret any inconvenience this may have caused.

Fig. 4 should appear as shown:

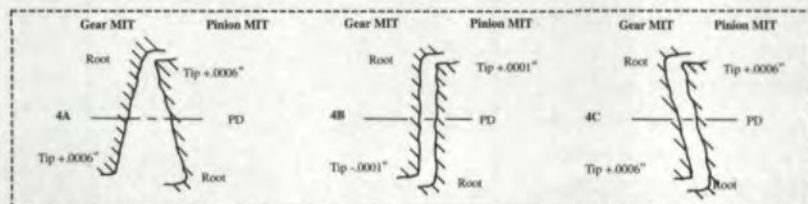

The equation that appears in the middle of page 21 should read,

$$\phi_A = \phi - (57.3)^2 \frac{2 \text{ (MIS)}}{d_B = (\epsilon_2 - \epsilon_1) \tan \phi}$$

The Bridges of Cook County and Other Sagas

Gear Technology's bimonthly aberration — gear trivia, humor, weirdness and oddments for the edification and amusement of our readers. Contributions are welcome.

In spite of being the "Second City," Chicago has always cultivated a reputation for bigness. We're known for big talk, big shoulders, big basketball players—and big gears. While not necessarily the biggest in the world (more about that later), some Chicago gears are among the hardest working.

Take, for example, our bridge gears.

Among the city's other claims to fame is that it is the home of the double-leaf trunnion counter-balanced bascule bridge—the lift bridge for short. The span of such bridges splits in the middle, each side lifting toward the shore to leave the river passage open.

Crucial to the working of the bridge is the rack and pinion system that raises and lowers the leaves (the equivalent of a block or more of city street) several hundred times a year in all weathers.

Each of the 32 bridges across the Chicago River is one-of-a-kind, but the one at E. 106th St. is fairly typical. Built in 1927, each of its leaves is lifted by a curved rack with 46 teeth and an 18' pitch circle radius. It moves through an arc of 78° 49'. It is driven by a 14-tooth pinion or bull gear with a pitch diameter of 31", a root diameter of 28" and an outside diameter of 36". Its pitch radius is 15.5". Both the rack and pinion are made of cast steel.

The reduction gears in the motor that drives the system aren't wimpy either. The pinion has 15 teeth and an outside diameter of 17". The three gears have 59, 71 and 125 teeth with outside diameters of 86", 73" and 50.8" respectively. According to the blueprints, the teeth all "conform to the Brown & Sharpe, stan-

dard, 14.5° involute, except that the pitch line thickness of the tooth shall be 0.49 times the circular pitch to provide backlash." (Our thanks to Stan Kaderbek of the City of Chicago Dept. of Transportation for sharing his insights and his blueprints.)

Mr. Ferris's Wheel

Some Chicago gears work hard at providing good times. The Ferris wheel, named after its builder, G.W.G. Ferris, was introduced here at the 1893 World Columbian Exposition. The original wheel was driven by a series of gear plates fitted around the rim. The teeth on the plates fitted into a pair of endless chains at the base of the wheel, rather on the same principle as the bicycle.

The original Ferris wheel is long gone, but it has been reincarnated down at Navy Pier. This big wheel is 150' high and 139' in diameter. It is driven by a

DC drive consisting of eight synchronized motors.

Michael Emerson of VOA Associates, the pier's architects, points out that the Ferris wheel can be viewed as a giant toothless gear set. The eight motors drive eight balloon wheels (think giant rubber tires), which meet the outer diameter of the wheel and drive it by friction.

And Big Gears From Down Under

The World's Biggest Gear Saga, cont'd. Addendum has received a fax from Mr. Peter Mayo of Toronto, N.S.W., Australia. He tells us that the company Envirotech has designed and installed a 92 meter (302') diameter "red-mud" thickeners in Western Australia. Around the perimeter of the tank is a series of toothed racks which form a circle of 93 meters (305'). The rack forms the final drive for the thickener stirring device.

Mr. Mayo also raises an interesting philosophical question. Since neither this thickener rack nor the Bucyrus-Erie dragline rack mentioned in our last issue move, are they "real" gears? Or should that name be reserved for gears that rotate? If so, what do we call these big rack drivers? And what are "real" gears anyway? Real as opposed to what? Unreal? Fake?

Anyone ready to take on the metaphysics of gears? Addendum is up for it if you are. ☉



"Well, as it turns out, the turkey in the company raffle is none other than old Edsy down in accounting."

The Addendometer: If you've read this far on the page and enjoyed it, please circle 225.

With **Forest City Gear**
You've Landed the
Best Gears Possible!



**Stop Fishing for a
Gear Manufacturer**

**We offer World Class
Gear Quality**

- Crown Hobbing for noise reduction and misalignment compensation.
- Hard Hobbing with carbide hobs after heat treat as a substitute for gear grinding.
- CNC hobbing and shaping alignment programs for varying teeth and pitches.
- Precision analytical gear inspection.
- Hob sharpening.

We Welcome Our Competitors

See Our Website

<http://www.fcgear.com>

or

**Come Visit us to
See a Mini Gear Show**

*The Most Modern
Fine and Medium Pitch Gear Job Shop
in the World!*

FOREST CITY GEAR

11715 Main Street

P.O. Box 80 • Roscoe, Illinois 61073-0080

815-623-2168 • Fax 815-623-6620

CIRCLE 138

Member of the
American Gear
Manufacturers
Association



#2 IN A SERIES



YES, GLEASON

HAS IT!

HONING



Process Optimization

There's more than one way to finish spur and helical gears. Based on your quality and noise requirements, and your cost objectives, we'll help you zero in on the best process combination, matching our advanced CNC shaving, grinding, and/or honing machines with our PHOENIX® hobbing technology.

How Honing Can Improve Quality and Reduce Cost

The quality enhancement and cost-saving possibilities of today's CNC honing are worth exploring. Honing is a hard finishing process that utilizes a honing tool in the form of an internal gear to improve tooth geometry and surface texture of hardened gears.

The Gleason-Hurth ZH 250 CNC Honing Machine combines easy-to-understand operating software with complete CNC process control. All operating aspects are fully automatic. Integrated part load/unload automation is optional.

Reducing Process Steps

In some cases, a Hob/Heat Treat/ Hone sequence can eliminate a previously-required shaving operation while improving quality. Depending on stock removal and quality requirements, honing can potentially replace grinding, with significant cost savings per gear.

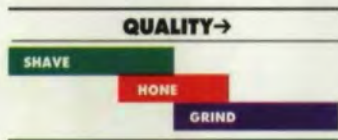

Honing can also be added to enhance shaving or grinding to meet today's stricter quality and noise requirements. We can help you analyze your current methods to determine if honing can be productively applied.

Whether the solution involves hobbing, grinding or honing...or any combination...we have the proven technology, and we back it with Gleason's

worldwide training and service support.

Call 1-800-643-2770 or your Gleason regional sales manager. The answer is "Yes."

COME SEE US AT
IMTS 96
CHICAGO — SEPTEMBER 4 - 11, 1996

GEAR PAVILION
BOOTH #7170

The Gleason Works, 1000 University Ave., Rochester, NY 14692
716/473-1000 Fax: 716/461-4348

Gleason

CIRCLE 100 or call 1-800-340-1160 x9100