

GEAR TECHNOLOGY

The Journal of Gear Manufacturing

**1998 BUYERS GUIDE ISSUE —
OUR BIGGEST EVER**

November/December 1997

**GEAR CRACK PROPAGATION
GEAR SHAVING BASICS**

Plus • A New Column: The Gear Business
And • The Addendum Guide to Holiday Shopping

THE GEAR INDUSTRY'S INFORMATION SOURCE

Gleason

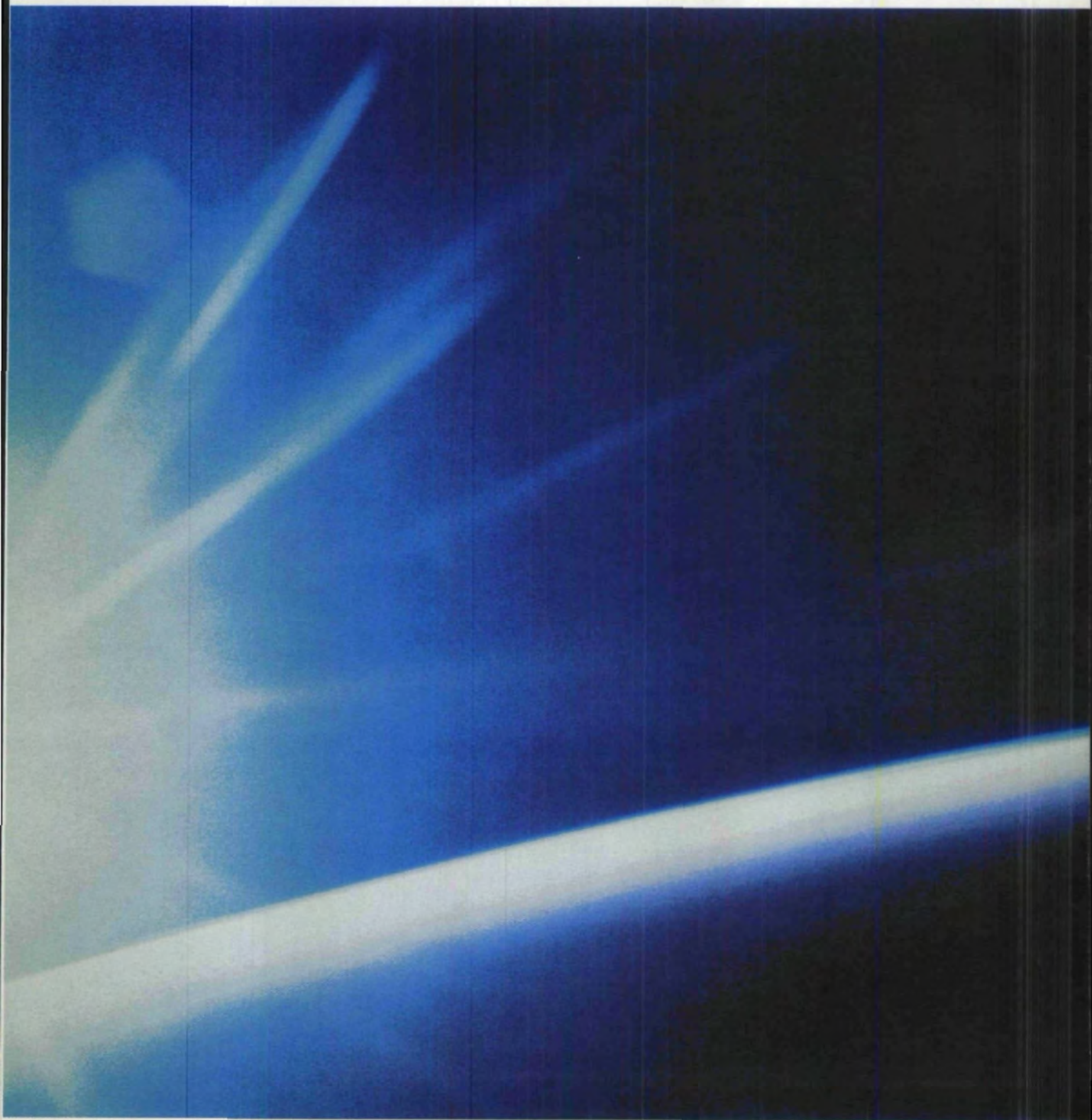

PFAUTER

**The
dawn
of a
new
era.**

Going into the next millennium, gear manufacturers in every industry will need bold new machine and tooling solutions to gain the advantage in fierce competition worldwide.

They'll find it at Gleason/Pfauter.

What brings these two world leaders in bevel and cylindrical gear manufacturing together is a shared commitment to delivering

new gearmaking technologies to the global marketplace...

technologies that ultimately lead to a customer's ability to bring product to market faster, more economically, and with greater quality than ever before.



After all, if Gleason and Pfauter were that good operating independently, then imagine what they can do together...

Gleason/Pfauter. The dawn of a new era.

Gleason/PFAUTER

The Gleason Works, 1000 University Ave., Rochester, NY 14692
Phone: 716/473-1000 • Fax: 716/461-4348

American Pfauter L.P., 1351 Windsor Rd., Loves Park, IL 61111
Phone: 815/282-3000 • Fax: 815/282-3075

Pfauter-Maag Cutting Tools L.P., 1351 Windsor Rd., Loves Park, IL 61111
Phone: 815/877-8900 • Fax: 815/877-0264

STAR PRECISION HOBS... BECAUSE NOT ALL GEARS ARE CREATED EQUAL



The only way to get top quality gears, is to machine them with precision hobs. At Star Cutter, we utilize the most advanced technology available to insure that each of our precision hobs will deliver the exact performance you need – cut after cut, day after day.

Take advantage of our experienced engineering department to design and develop the most economical hob to meet your individual special unique gear manufacturing requirements. These hobs are available with Gold Star titanium nitride, titanium carbo-nitride and other advanced Gold Star coatings.

If faster-running, quieter and more accurate gears are your objective, you can't do better than Star. Call, write or fax for more information.

ISO 9001/9002 CERTIFIED

Since 1927

 **Star**[®]
STARCUT SALES, INC.
Subsidiary of Star Cutter Company

P.O. Box 376
Farmington, MI 48332-0376
248/474-8200 FAX 248/474-9518

CIRCLE 128

GEAR TECHNOLOGY

NOVEMBER/DECEMBER 1997

The Journal of Gear Manufacturing

FEATURES



18

Gear Crack Propagation Investigations

How gear rim thickness affects crack growth and life.....18

Gear Fundamentals Gear Shaving Basics, Part I

The ABCs of this important gear making method.....26

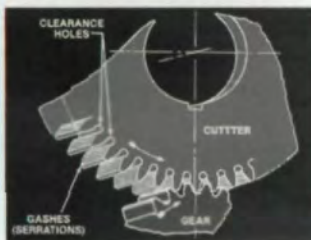

26

1998 BUYERS GUIDE

The companies, the products, the services.
Our biggest, most complete directory ever.....33

1997 ARTICLE INDEX

Complete listings by subject.....64

DEPARTMENTS



72

Publisher's Page

Good-Bye, Dad.....7

Industry News

What's happening now.....10

A New Column: The Gear Business

Capitalizing on Your Human Capital.....11

Viewpoint

Our readers react.....17

Technical Calendar

Events of interest.....31

Advertiser Index

Check this important page.....68

Classifieds

Products and services you can use.....70

Addendum

Holiday gear giving.....72



Cover art courtesy of
Koeper-America, LLC,
South Elgin, IL.

THE GERMAN MACHINE TECHNOLOGY GROUP



*...for whatever gear
machining you may need*

ONE SOURCE for a variety of precision gear machining disciplines. Featuring the machines of world class manufacturers:

American WERA, Hurth MODUL and PRÄWEMA. Our package includes machines, planning and engineering by experienced gear specialists, plus testing, installation and service. Call today for details on:

- PROFILING
- SPLINE CUTTING
- GEAR HOBBING
- GEAR TOOTH POINTING
- BEVEL GEAR CUTTING
- GEAR HONING



4630 Freedom Drive
Ann Arbor, MI 48108
313 973-7800
Fax 313 973-3053

CIRCLE 197

KOEPFER CARBIDE HOBS Dare to Compare!

Koepfer has been supplying the **highest quality** carbide hobs for over 25 years. Our hobs have consistently provided **longer tool life** due to the **superior grades of carbide** that are used. Koepfer manufactures hobs to AGMA, DIN, or your specifications.

- Koepfer America now provides common carbide hobs from stock.
- We will also establish a stocking program for you.
- Extra long, multi-start, high gash number tools to fit your machines are also available.
- For a competitive quote, please call or fax us.



KOEPFER

Koepfer America, L. L. C., 635 Schneider Drive, South Elgin, IL 60177
(847) 931-4121 Fax: (847) 931-4192

CIRCLE 116

GEAR TECHNOLOGY

The Journal of Gear Manufacturing

EDITORIAL

Publisher & Editor-in-Chief
Michael Goldstein

Associate Publisher & Managing Editor
Ed Mueller

Senior Editor Nancy Bartels

Associate Editor William R. Stott

Technical Editors
Robert Errichello
Don McVittie
Robert E. Smith

Editorial Intern Otis G. Williams

ART

Art Director Jean Bartz

ADVERTISING

Advertising Manager
Patricia Flam

Ad Sales Coordinator
Elizabeth Melone

CIRCULATION

Brian Sessler
Daniel S. Wachula

RANDALL PUBLISHING STAFF

President Michael Goldstein

Vice President Richard Goldstein

Vice President/General Manager
Ed Mueller

Controller Patrick Nash

Accounting Laura Manion

Art Consultant Marsha Goldstein

Phone: 847-437-6604
e-mail: people@geartechnology.com



VOL. 14, NO. 6

GEAR TECHNOLOGY, The Journal of Gear Manufacturing (ISSN 0743-6858) is published bimonthly by Randall Publishing, Inc., 1425 Lunt Avenue, P.O. Box 1426, Elk Grove Village, IL 60007. (847) 437-6604. Cover price \$5.00 U.S. Periodical postage paid at Arlington Heights, IL, and at additional mailing office. Randall Publishing makes every effort to ensure that the processes described in GEAR TECHNOLOGY conform to sound engineering practice. Neither the authors nor the publisher can be held responsible for injuries sustained while following the procedures described. Postmaster: Send address changes to GEAR TECHNOLOGY, The Journal of Gear Manufacturing, 1425 Lunt Avenue, P.O. Box 1426, Elk Grove Village, IL, 60007. ©Contents copyrighted by RANDALL PUBLISHING, INC., 1997. Articles appearing in GEAR TECHNOLOGY may not be reproduced in whole or in part without the express permission of the publisher or the author. Contents of ads are subject to Publisher's approval.

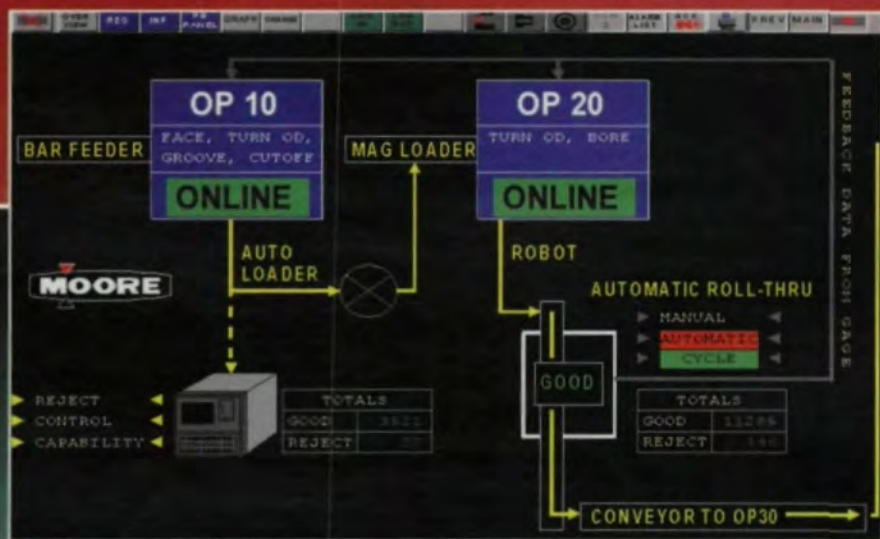

Only MOORE can help you set up very affordable process measurement & control

MOORE windows-based real-time monitoring system is available for integrating gaging and production equipment.

MOORE OFFERS THE INDUSTRY'S WIDEST RANGE OF FUNCTIONAL GAGING SYSTEMS FOR GEAR PRODUCTION

For high volume gear inspection systems, you can't beat Moore. Here's why:

MOORE Experience

Moore has been designing and producing high quality, reliable gaging systems for more than 50 years.

MOORE Technical Back-up

Moore's U.S. operations provides over 1,000 employees and a 375,000 sq. ft. manufacturing facility, full engineering services, plus additional operations worldwide.

MOORE High-end Electronics

Moore's Gaging Division draws on the technical skills and experience of the Moore Products Co., Instruments and Controls Division, which produces state-of-the-art computer systems and software for process control.

MOORE's Size

Moore is large enough to handle major programs and specialized enough to assure you personal attention.



Automatic light mesh inspection system



Semi-automatic tight mesh inspection



Universal center distance gear checker



Pitch diameter inspection gage



Modular gear blank fixture



Manual roll stand

Call Or Fax The Moore Gear Gaging Experts Now

Tel: 1-215-646-7400 Ext. 2352
Fax: 1-215-653-0347

Attn: Gage Division, Gear Team

Moore Products Co., Gaging Division
Sumneytown Pike, Spring House, PA 19477



"The Measurable Difference"



Small Part Broaching Solutions In The Palm Of Your Hand

National Broach has over 70 years of experience equipping the industry with large broach tools of exceptional quality. Now, we bring that same standard of quality and expertise to broaching tools with diameters as small as $\frac{3}{4}$!"

Quality is assured because we control every step of manufacturing the tool, from Design and Machining through Heat Treating. National Broach utilizes the latest Total Quality practices, the newest methods for Statistical Process Control, and the most modern CNC manufacturing equipment available.

National Broach is your one-stop supplier of precision broach tools:

- ◆ Conventional & Spiralglide gullet
 - ◆ Spur & Helical
 - ◆ Spline & Serrations
 - ◆ Cam
 - ◆ Round
 - ◆ Special Form
- ◆ Blind spline
- ◆ Surface
- ◆ Pot
- ◆ Resharpener Service

For a complete line of products, expert support, and prompt delivery, call National Broach – your single-source broaching supplier.



National Broach & Machine Co.

17500 Twenty-Three Mile Road, Macomb, Michigan 48044
Phone: 810-263-0100 Fax: 810-263-4571

Good-Bye, Dad

Harold Goldstein, 1917–1997

I sat down to write this editorial about my father, Harold Goldstein, as he approached his 80th birthday in October. I had meant it to be a celebration of his nearly 65 years in the machine tool business. Unfortunately, on August 26, as I was working on it, my father passed away after a long battle with emphysema. This editorial has now become a memorial as well as a celebration.

In many ways, my father's story was that of his generation. He entered his teenage years at the beginning of the Depression and spent his young manhood in a world shattered by war. He had to leave high school in his second year to earn money to help support his family and never knew the easy security that comes from having (or at least believing one has) a guaranteed lock on one's fair share of the good things in life.

But these early experiences strengthened him. Along the way, he made sure his own children had some of the important things he'd missed in the formative stages of his life; not so much material things, although he took care of that as well, but a strong sense of the importance of family, togetherness, love and caring.

He was self-taught. He turned himself into a very well-read, articulate individual, and his knowledge of accounting, business law, sales and marketing came on the job. In 1950, he struck out on his own from the business he ran with his father and founded Cadillac Machinery.

Dad also earned the trust and respect of his colleagues. Along with his father, he was one of the founding members of the Machinery Dealers National Association (MDNA) and became its national president in 1967-8. Later, in 1971 he was awarded the organization's Randolph K. Vinson Award for outstanding contributions to the industry. But he was particularly proud that he, with no formal education, was selected to represent the machine tool industry and the MDNA to give testimony before the House Ways and Means Commission with respect to the Investment Tax Credit.

He placed a tremendous importance on education as a tool to help us move through our lives, and he always stressed that importance to his children.

And it wasn't just "book learning" he impressed on my brothers and sister and me. In spite of all his early disadvantages and the hardships he faced during his formative years, there were certain admirable personal truths he lived out and taught his children, lessons which have helped to give my life some focus and direction. . .

. . . Your Word Is Your Bond. . . Be Scrupulously Honest. . . Don't Be Just A Taker In Life; Give Back As Well. . . It's Easy To Write a Check to a Charity; It's Harder, But More Useful, to Give Your Time, Experience and Talent. . . Fight For What You Believe and Stand Up For What You Think Is Right, Even If It's Not Popular. . . You Can't Be Successful If You Work Only 40 Hours a Week. . . Your Company Doesn't Pay Your Salary; Your Customers Do. Without Them, You Don't Have A Job or A Business. . .

To help his children to have a wider vision of any given situation, my dad would constantly tell us, "You don't know what you don't know."

Throughout my life, I have found this last statement to be particularly insightful. It's taught me to look beneath the surface of situations; to assume that, most of the time, there's more going on than first meets the eye; that things are generally deeper and more complex than they first appear. It's helped me to avoid making superficial judgments, not to be too cocky too early in the game and to do my homework.



Harold and his wife, Susan.

Fässler Focusing on Direct Honing!

Fässler K-300 & K-400 Gear Honing Machines



Fast, economical hard gear finishing process that increases gear life while reducing or eliminating gear noise.

- Internal or external gears
- Spur, helical, or cluster gears

With Direct Honing you can hob, heat treat, and hone your gears to market requirements.

With Universal Honing it is possible to finish a family of gears having the same tooth characteristics with varying numbers of teeth.

With Combi-Honing you can rough and finish on the same machine with honing stones mounted in tandem.

MACHINE FEATURES:

- 5 and 6 CNC controlled axes
- Synchronous drives on the K-400
- CNC control of lead crowning and taper
- Short setup times

CHARACTERISTICS OF HONED GEARS:

- Increased wear resistance
- High surface finish
- Favorable machining marks for noise reduction
- Low surface roughness guarantees a permanent oil film

Fässler

Fässler Corporation
11782 N. Maple Road
Germantown, WI 53022
Phone: 414-255-0695
Fax: 414-255-9676
E-Mail: fassler@execpc.com

Fässler AG
Ringstrasse 20
CH-8600 Dübendorf
Switzerland
Phone: 011-411-821-3745
Fax: 011-411-820-3906

Fässler makes good gears better!

PUBLISHER'S PAGE

Working with and for my dad, I learned about industriousness, leadership, tenacity, ambition, self-confidence and perseverance. Dad could be a tough boss, but he was a fair one, and I was fortunate to have mostly his praise and admiration as I went through my own career.

He provided a tower of strength for our companies, Cadillac Machinery and Randall Publishing. Even after he was no longer strong enough to come into the office, he had a seemingly inexhaustible supply of interest and enthusiasm for the business. I spoke to him nearly every day, and he always had the same questions: What did we buy today? What did we sell? What new projects were we working on?

And he had the same kind of interest and concern for the larger industry and for both our immediate and extended families. He was a patriarch in the truest and best sense of the word.

The end of his life, like the beginning, was not easy, but even when he was quite ill, he continued to teach us by example. He put his affairs in order quietly and efficiently so his family would be spared the burden of tying up the loose ends. He called those close to him together to say his good-byes, an act of closure that's been deeply meaningful to me these past few weeks. He met his end with a courage, grace and dignity that made me even prouder to be his son. His job was done, he was rightfully proud of what he accomplished, and he went in peace.

Once this summer, reflecting on the number of his family and friends throughout the world who called or came to visit with him, he said, "I guess I did something right."

Dad, you did so many, many things right. We're going to miss you.



Michael Goldstein
Publisher & Editor-in-Chief

DIAMOND-LIKE CARBON

amorphous diamond

Diamonex[®] (DLC) Diamond-Like Carbon Coatings

Low Temperature CVD Plasma & Ion Beam Deposited Thin Film

Diamonex[®] DLC is a conformal, superhard and low friction coating of an amorphous form of carbon with diamond bonds. Amorphous carbon is a material whose properties resemble, but do not duplicate, those of natural Diamond.

- WEAR/ABRASION RESISTANT
- LOW FRICTION
- HIGH HARDNESS
- CORROSION RESISTANT
- GAS BARRIER
- CONFORMAL COATINGS

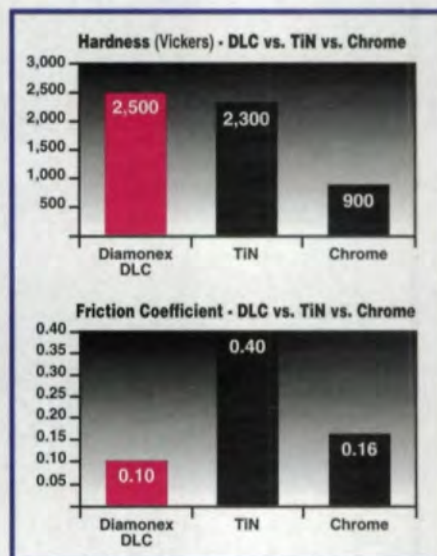

MATERIAL PROPERTIES

Hardness (Vickers)	1,000-3,000* (adjust.)
Friction Coefficient	< 0.1 (as-deposited)
Coating Thickness	.001 - 10µm
Max. Working Temp.	500 °C
Deposition Temp.	< 150 °C
Chemical Resistance	Inert
Electrical Resistivity	10 ⁶ -10 ¹² (ohm-cm)
Coating Finish	Identical to substrate

Commercial/Industrial DLC Applications

- Aerospace
- Automotive
- Bearings
- Electronics
- Instrument
- Medical/Dental
- Metalworking
- Textile
- Tools/Dies/Molds
- Industrial Wear Parts

For additional information contact Joseph Rogers at: 610-366-2106, FAX a request to: 610-366-7144 or visit us at: www.diamonex.com



Diamonex[®]
PERFORMANCE PRODUCTS
A Unit of Monsanto Company

7331 William Ave.
Allentown, PA USA
18106

Rock Valley Apprenticeship Program To Graduate First Class

The first group of seven students will complete their training in the Rock Valley College Manufacturing Youth Apprenticeship Program next spring. Upon graduation, they will have earned their Associate of Arts degrees from Rock Valley College or their journeyman's card from the Rockford Tooling and Machine Association.

The Rock Valley Apprenticeship Program is part of the nationwide Tech Prep program. It is modeled on the German apprenticeship program, which combines academic study with on-the-job training.

Students begin their training in their junior year of high school. The program is a combination of classroom and on-the-job training, including an extensive summer school program between the junior and senior high school years. After com-

pleting high school, students go on to a four-year apprenticeship program.

The apprenticeship training facility is located at the Pfauter-Maag Cutting Tools facility in Loves Park, IL, and Pfauter-Maag was one of the original sponsoring companies of the program.

Twenty-eight manufacturing companies in the Rock Valley/Rockford area are involved. Since 1993, some 140 students have participated in the program, which boasts a 70% retention rate.

M & M Precision Systems Acquires New Product Line

M & M Precision Systems Corp., manufacturer of gear inspection systems, has acquired the product lines of Apeiron, Inc. of Bloomington, MN. M & M will manufacture these laser dimensional measurement systems and market them worldwide under the M & M name. These non-contact laser measurement systems can accurately and rapidly identify dimensions on surfaces that cannot be measured by traditional contact methods.

Bison Gear Opens New Facility

Bison Gear and Engineering has officially opened its new world headquarters and gear motor manufacturing plant in St. Charles, IL. The 115,000 sq. ft. facility on 9.7 acres brings all the Bison operations under one roof.

The new building, designed and built to Bison's specifications, houses administration, finance, sales and marketing, research and development, warehousing and manufacturing. Special amenities include a gear technology center, a fitness center for employees and training facilities for professional and personal advancement. It has high technology equipment for hobbing, machining, gear inspection and assembly and testing.

DR. KAISER
precision through diamond

for Gear Dressing Applications

We will design, build and guarantee from your gear summary charts gear dressers for **Reishauer SPA** and **Fassler DSA Systems** Direct-Plated or Sintered-Bond Single- or Double-Sided Dressers.

We also produce gear dressers for

- Gleason CNC & Phoenix
- Niles
- Okamoto
- Liebherr
- Csepel
- Normac
- GII Solutions
- Høglund
- Höfler

We offer our customers

- Highest Accuracy
- Competitive Prices
- Fastest Delivery
- Relap & Replating Service

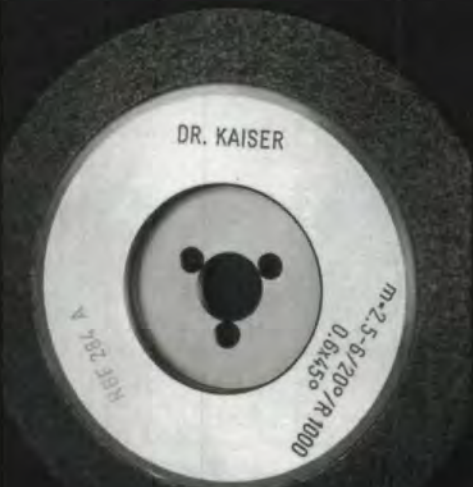

Call or fax us your gear dresser requirements.
You will quickly discover what leading U.S. gear producers have learned.
Dr. Kaiser gear dressers are the best value available.

Imported by

**S.L. Munson
& Company**

1517 Gregg St., Columbia, SC 29201
1-800-775-1390 • 1-803-252-3211
Fax 1-803-929-0507

Tell Us What You Think . . .

If you found this article of interest and/or useful, please circle 201.

Capitalizing on Your Human Capital

Skill levels, productivity and labor availability all affect your bottom line.

Dr. Michael D. Bradley

A fundamental characteristic of the gear industry is that it is capital intensive. In the last decade, the gear manufacturing industry has been undergoing an intense drive toward improving and modernizing its capital equipment base. The Department of Commerce reports that annual sales of gear cutting equipment have increased nearly 60% since 1990. While this effort has paid off in increased competitiveness for the American gear industry, it is important to remember that there is another capital crucial to manufacturing success—"human capital."

Human capital is the set of skills, knowledge and abilities that makes an individual productive. The higher an individual's skill level, the more productive he will be and the more he will earn. This is exactly parallel to a new machine generating a higher rate of return than an older, less productive machine. Human capital is generally acquired through education and training. An engineer, for example, dramatically increases his or her human capital by going to college.

A gear manufacturer's human capital stock is mea-

sured by adding together the individual human capital of all its workers. Just as the total productive capacity of the physical capital stock is measured by adding up the physical capacities of the individual pieces of equipment, so too is the human capital stock measured.

Unfortunately, this sometimes doesn't get done. For one reason, acquisition of human capital doesn't typically require the outlay of a single huge pile of cash; a gear company makes payments gradually to workers through time. These gradual payments take away a natural point of focus in analyzing the human capital stock.

Another reason the human capital stock is less closely monitored may be that the state of human capital is more difficult to assess than that of machinery. Finding standards that measure and describe the status of human capital in an industry is often hard.

Fortunately, this latter problem is being remedied in the gear industry. The American Gear Manufacturers Association annually produces a comprehensive study of the state of human capital in the gear industry, called "Wage and Benefit Survey." This survey provides insight

into the three important aspects of human capital stock which gear manufacturers should be monitoring. These are the expense of hiring the labor, the training and skill level of the labor force and the availability of skilled labor, both in the present and future.

The expense of hiring labor shows up in the quarterly bottom line, and it is this aspect of human capital that gets the most attention. According to the AGMA study, the average hourly wage paid to a direct worker in the gear industry is \$12.65. Adding average hourly benefits of \$7.20 per hour gives an average total hourly compensation of \$19.85, or an average cost of \$40,000 per year or \$1.2 million during the worker's potential employment. Moreover, this represents the average direct employee's wages, including both low and high skilled employees. When just skilled workers, like tool makers or CNC machinists are considered, the lifetime compensation cost can climb to more than \$1.5 million. Viewed in this way, it is clear that gear manufacturers make a substantial investment in their workers.

The average gear manu-

**ACCORDING TO
AGMA THE
AVERAGE HOURLY
WAGE IN THE
INDUSTRY IS
\$12.65 PLUS \$7.20
IN BENEFITS,
MAKING FOR A
TOTAL PACKAGE
OF \$19.85
AN HOUR.**

facturer is small—less than half have more than 100 direct workers—but even with just 100 employees, the annual cost of compensation can exceed \$4 million. Moreover, this sum does not include additional indirect labor costs like training, administration and other non-direct human resource activities. It also does not include selling costs, engineering costs or management costs. In addition, compensation is even higher at unionized gear manufacturers, with between one quarter

In Plant Spline Seminars



presented by

FRENCO

If the very success or failure of your parts depend on the quality of the spline, Franco spline seminars are the perfect answer to a full understanding of this difficult profile. With over 20 years of spline experience, Franco's professional trainer will educate designers, producers and inspectors in the subjects of:

Standards • Tolerancing • Inspection Methods • Design • Manufacturing

To receive more information, or schedule the worlds most complete spline seminar, call or fax us.

14685 Lisbon Road
Brookfield, WI 53005
Ph. 414-781-6777
Fax 414-781-2822



CIRCLE 147

THE NEW CHAMFERMATIC MODEL 1600



STANDARD FEATURES

- Gear Diameters Through 16"
- 8" Diameter, 3-Jaw Manual Chuck
- P. L. C. With Operator Interface
- Automatic Air Operated Door
- Built-in Air Filtration System
- (2) Two Grinding Head Assemblies
- (2) Two-Year Limited Warranty

Portable

Optional equipment such as Air Chucking, Auto Load and Unload, or additional Grinding or Brushing Heads will be quoted upon request.

If a machine isn't in your plant at this time, contact us about your deburring needs.



1696 Northrock Ct., Rockford, IL 61103

Mike Magee, President

Ph: (815) 636-5082

Fax (815) 877-5787

CIRCLE 171

THE GEAR BUSINESS

and one third of gear firms being unionized. Compensation is about 30% higher at unionized firms, so the compensation cost at a unionized, 100-worker gear company can exceed \$5 million a year.

Given the size of these costs, it is important for gear manufacturers to control their growth. One area in which they have been successful is in health care costs. The AGMA study shows that, after years of rapid growth, the annual average health care cost per employee has grown little in recent years. In fact, annual employee health care cost has grown by only 3% over the last two years, a rate that is less than that of inflation. Gear firms have achieved this success by aggressively pursuing cost-saving strategies, such as by switching to managed care, switching carriers, increasing employee contributions to premiums and increasing deductibles.

Worker's compensation is another example. After several years of sharp increase in premiums, about half of gear firms have undertaken safety plans that reduce accidents. This has two benefits: It reduces worker's compensation premiums, and it reduces the lost productive output from injured workers. The point is, when a human capital issue comes to the attention of gear manufacturers, they can take successful steps to address it.

The worker's compensation issue also helps to reveal the dual nature of the human capital issue for gear manufacturers. While the level of compensation is obviously important, it is only half of the human capital story.

High wages by themselves are not necessarily a burden for a firm. In fact, some firms that pay the highest wages are the most profitable.

The other half of the human capital story is the productivity of the labor. The higher the human capital content of the labor force, the greater its skills and abilities, and the more productive it will be. A useful summary of the important relationship between a firm's compensation cost and the productivity of its labor is given by a measure called "unit labor costs." Like the internal rate of return to physical capital, this is a measure that helps a gear firm figure out how well it is managing its labor force.

The unit labor cost measure recognizes the two parts of labor costs. It accounts for both the rate of compensation to workers and the amount of labor required to produce output. In this sense, it is the mirror image of productivity. When productivity rises, output-per-labor-hour rises. When productivity rises, the labor hours required to produce a single unit of output falls. This mirror image of productivity is called the labor content of output, and it falls as productivity rises.

Unit labor cost is derived by multiplying this measure of labor content by the rate of average hourly compensation, and is, therefore, a dollar measure of the labor cost of producing a unit of output. When unit labor costs are falling, productivity is rising faster than wages, indicating that the gear manufacturer is doing a good job managing its human capital. Falling

Building Relationships Means:

SETTING STANDARDS OF VALUE

WITH CUSTOMERS - FOR CUSTOMERS



TECHNOLOGY

Surface has excelled for more than 80 years in applying its broad thermal processing technical abilities to new and unusual customer processing applications. These applications reach the full spectrum of vacuum, atmosphere, and non-atmosphere process demands. Surface technology is developed with customers for use in every day processing requirements.



RELATIONSHIPS

The strength of Surface comes from the customer relationships built and maintained throughout our long history. Customer satisfaction and growth continues to be the key to our success. Surface combines tradition, integrity, and technology to help our customers achieve long-term success. Surface is truly in business with customers, for customers.



SUPPORT

Surface dedicates a wide range of resources in support of our customers. When you commit to Surface products, you gain the support of a large field service force, an equipment retrofit & up-grade department, a strong technical services group, a full R&D department, and one of the largest parts inventories in the industry.



Surface[®] Combustion



SURFACE COMBUSTION, INC. ▲ 1700 INDIAN WOOD CIRCLE ▲ MAUMEE, OH 43537 ▲ PH. (800) 537-8980, (419) 891-7150 ▲ FAX (419) 891-7151

CROWN GEAR

Angular transmission or tooth coupling?

With Cylkro® face gears the choice is up to you. Paired with a cylindrical pinion, the Cylkro® gear is the revolutionary alternative to bevel gears. The combination of two spur Cylkro® gears stands for a zero-backlash tooth coupling. Interested?

Feel free to give us a call.



CROWN GEAR B.V.

Buurserstraat 200 NL-7544 RG Enschede
Tel. +31-(0)53-4773622 Fax +31-(0)53-4779147

CIRCLE 167

Gear Checking for your Cordax®

Now you can inspect gears and parts on a single system—with DirectGear™ inspection software for your Cordax DCC CMM.

- Check external and internal dimensions of spur and helical gears without dedicated gear checking equipment.
- Automatically measure gears and output standard graphs and data.
- Simple, menu-driven interface.
- Fast setup—no workpiece alignment, master gear or indexing table required.

Call 937/254-5377 or fax 937/254-5054 for all the details.

GIDDINGS & LEWIS®
SHEFFIELD MEASUREMENT®

CIRCLE 126

THE GEAR BUSINESS

unit labor costs also help profitability because declining unit labor costs mean that profits will rise without an increase in prices. This is crucial during a period of intense competition.

While unit labor costs measure how quickly labor productivity is rising relative to compensation, it tells us nothing about efforts to improve labor productivity. Even in an economy with modest inflation, wages tend to rise every year, and without an increase in productivity, higher wages mean higher unit labor costs and lower profitability. Therefore gear manufacturers must try to continuously improve the productivity of their work force.

The primary way gear manufacturers accomplish this for direct workers is through training. While there are some bright spots, this is an area in which the American gear industry is not particularly strong. For example, less than a quarter of gear manufacturers have apprenticeship programs. These programs are the fundamental way in which relatively new workers can rapidly increase their productivity through organized programs of skill transfer. This lack of apprenticeship programs stands in marked contrast to gear industries in other countries that tend to have well-established and successful apprenticeship programs.

It is true that several gear manufacturers have started partnerships with local community colleges. These programs include donations of old equipment, the establishment of scholarships for studying gear manufacturing

and the creation of coordinate work/study programs. Unfortunately, these programs are still the exception rather than the rule.

Gear manufacturers have begun to offer incentives for workers to get skills and become more productive. For example, the AGMA study reveals over the last three years a dramatic increase in the number of gear firms that "pay for knowledge." In 1994, less than 10% of the gear firms offered this incentive plan, but by 1996 more than 25% were offering it. Pay-for-knowledge programs provide financial compensation for the acquisition of additional skills. For example, some gear firms pay a premium to workers who can operate multiple machines. To be effective, this premium must be substantial, and it is averaging about 85 cents per hour among the gear manufacturers that use them.

Another incentive for workers to increase their productivity is through profit-sharing plans. In these plans, a worker's total compensation is linked to the performance of the firm. Usually, the firm's contribution to the worker's pension program depends upon firm performance, but 17% of

**TIGHT LABOR
MARKETS
IMPLY RISING
WAGES THAT
WILL DRIVE UP
LABOR COSTS.**

gear manufacturers have profit-sharing programs in which workers' current pay depends upon current profits.

Of course, no incentive plan will work unless the gear manufacturer has the employees to work. The third important aspect of human capital in the gear industry is the availability of skilled workers. Given the rapid economic expansion in the gear industry in the last five years and the paucity of training programs, it is not surprising that many gear firms are having difficulty finding and hiring skilled workers. Some gear firms have reported that a shortage of skilled labor is currently limiting their capacity to produce. In other words, these firms have the machinery available to expand production, but simply cannot find the additional skilled workers to run the equipment.

The AGMA study tracks labor scarcity, and this problem has clearly become more severe in recent years. As recently as 1994, over a quarter of gear firms reported that grinder machinists were readily available, but by 1996, this percentage has fallen to just over 11%. Similarly 93% of gear companies reported that in 1996, toolmakers were scarce and difficult to hire.

This problem is unlikely to improve as time passes. The industry work force is relatively old, and as older skilled workers retire, finding the new workers to replace them will be difficult. Forty-three percent of gear manufacturing workers are more than 45 years old, and 82% are more than 30 years old. In an industry where a

current shortage of skilled labor already exists, this age profile foreshadows a continuing problem over the next two decades. Tight labor markets imply rising wages that will drive up unit labor costs. Unless productivity rises continuously, the labor shortage could provide an ongoing drag on the industry's profitability.

The American gear industry has made impressive strides in the last ten years to recapitalize itself and become world-class. However, not forgetting the "other" capital, human capital, is important. Labor costs remain a substantial part of gear firms' total costs, and the pressure to improve labor productivity continues. When we combine these factors with the current, and probable future shortages of skilled labor, the human capital dimension of gear manufacturing presents a persistent challenge for the future. ⚙

Michael D. Bradley

is Professor of Economics at the George Washington University in Washington, D.C. He has been a consultant to the gear industry for twelve years, and in 1996 he won AGMA's Executive Committee Award for "his efforts to enhance the art of management in the gear industry."

Tell Us What You Think . . .
If you found this article of interest and/or useful, please circle 203.

On Paper all Hobs Appear to be the SAME; That's where our similarity to other Hobs ends.

Saazor Hobs are manufactured differently

What the difference means to you is:

- 50% More Regrinds
- Eliminates Recoating Cost
- True Profile Over the Entire Tooth Length
- More Productivity or More Pieces per Regrind.

SAAZOR'S DIFFERENCES BENEFIT YOU

JRM International, Inc.

1214 Shappert Drive
Rockford, IL 61115
(815) 282-9330 • FAX (815) 282-9150

CIRCLE 131



BARIT INTERNATIONAL CORPORATION

**GEAR CUTTING TOOLS
DIAMETRAL & MODULE**

"ON THE SHELF INVENTORY"



- HOBBS
- SHAPER CUTTERS
1DP and finer
Made to AGMA standard

SPECIAL MADE TO ORDER TOOLS

- HOBBS
- SHAPER CUTTERS
- FORM RELIEVED INVOLUTE MILLING CUTTERS
- SHAVING CUTTERS
- BROACHES

BARIT INTERNATIONAL CORPORATION

3384 COMMERCIAL AVE.
NORTHBROOK, IL USA 60062-1909
TEL: 847-272-8128 • FAX: 847-272-8210

E-mail: barit@enteract.com
or visit us at <http://www.barit.com>

CIRCLE 175

STAR MILLING CUTTERS ... FOR LONG-LASTING RELIEF



Star form-relieved milling cutters deliver greater form accuracy and longer tool life – thus improving your manufacturing quality. The top-quality Star Cutter line includes single and duplex milling cutters, special form cutters, saw blade cutters and shell or shank-type multiple-thread milling cutters.

These long-lasting milling cutters are available in a wide range of sizes and configurations, and can be ordered with or without special Gold Star thin film coatings.

Call, write or fax for more information.

Since 1927

The Star logo features a stylized red and white 'S' shape to the left of the word 'Star' in a bold, italicized serif font.

STARCUT SALES, INC.
Subsidiary of Star Cutter Company

P.O. Box 376
Farmington, MI 48332-0376
248/474-8200 FAX 248/474-9518

Cyclo System Also New Technology

As always, I enjoyed reading your magazine. It was interesting and enjoyable to read your article about Mr. E. K. Buckingham, who I highly regard as an exceptional authority in the field of gearing in the U.S. His views sometimes do not conform with mainstream practices, opinions and standards as represented by AGMA. I strongly believe it is important to have individuals like him to avoid viewing things too one-sidedly.

I was somewhat disappointed that, according to your article, Mr. Buckingham says "only two new technologies come directly from the gear industry in the last 50 years," namely the Spiroid system and Novikov-Wildhaber gearing.

These two developments are certainly significant. However, I feel that the CYCLO gear system is a much more important new technology. Next to the numerous unique technical and practical advantages of this gear system, no other could achieve a real, economic success in the last 50 years. The CYCLO system, however, became the backbone of close to a billion-dollar gearbox/gear motor industry and is the only significant competitive system to classical involute spur/helical gears.

It is also odd that AGMA is not interested in devoting attention to this system. It seems to me sometimes that the classical gear manufacturers hope: "If we ignore the CYCLO system, it will go away." However, the CYCLO system is being continuously updated, refined and is gaining market share worldwide.

Gerhard Antony, PhD.
Vice President,

Sumitomo Machinery Corp. of America

The Kish Hunting Mesh Method

The Kish method for determination of hunting mesh, (Vol. 14, No.4) looks remarkably like Euclid's algorithm for finding the greatest common divisor of two numbers. Euclid invented his algorithm some 2,300 or so year ago, and here it is in your latest issue, still being useful.

Jules Kish is an estimable engineer, and I am more than glad to call it, as you do, the Kish method, but I think that Euclid deserves at least a nod and, from me, a wink when I do so.

Ron Mosier
Applied Mathematician
Chrysler Corp.

We welcome letters from our readers. Please send yours to us at 1401 Lunt Ave., Elk Grove Village, IL 60007, e-mail people@geartechnology.com. or fax us at 847-437-6618. All letters become the property of Gear Technology. Names will be withheld by request, but no anonymous letters will be published. Letters may be edited for space. Opinions expressed by contributors are not necessarily those of the editor or publishing staff.

Tell Us What You Think . . .

If you found this article of interest and/or useful, please circle 202.



**GEAR
MACHINES**

BRAND NEW GEAR MACHINES

- very attractive prices
- immediate delivery available
- 18 different models of shapers, hobbers, shavers, honers, grinders, hob sharpeners, and inspection equipment

You can afford a new Wolf gear machine.

Model GS20-9.5
Economy Gear Hobber
\$29,995
20" Diameter
9.5" Face



Model GH8-6FP
Fine Pitch Gear Hobber
\$46,995
8" Diameter
6" Face

Model GS8-3HS
Gear Shaper
\$64,795

8" Diameter
3" Face



over 35 years experience in gears and gear equipment

...always ahead of the pack!

NATIONAL DISTRIBUTOR:

**B
I
G**
INCORPORATED
GROUP

Telephone: (213) 933-0311
Fax: (213) 933-7487
P.O. Box 36276, Los Angeles, CA 90036

EASTERN REPRESENTATIVE:

SPECK GEAR SERVICES, INC.

Phone: (630) 213-8340 • Fax: (630) 213-8341
P.O. Box 88177, Carol Stream, IL 60188-0177

Gear Crack Propagation Investigations

David G. Lewicki and Roberto Ballarini

Introduction

A common design goal for gears in helicopter or turboprop power transmissions is reduced weight. To help meet this goal, some gear designs use thin rims. Rims that are too thin, however, may lead to bending fatigue problems and cracks. The most common methods of gear design and analysis are based on standards published by the American Gear Manufacturers Association. Included in the standards are rating formulas for gear tooth bending to prevent crack initiation (Ref. 1). These standards can include the effect of rim thickness on tooth bending fatigue (Ref. 2). The standards, however, do not indicate the crack propagation path or the remaining life once a crack has started. Fracture mechanics has developed into a useful discipline for predicting strength and life of cracked structures.

Ahmad and Loo (Ref. 3) applied fracture mechanics to gear teeth to illustrate the procedure and estimate crack propagation direction. Honda and Conway (Ref. 4) also applied fracture mechanics to simulate tooth crack propagation, compute threshold loads and calculate tooth life. Flasket and Jezernik (Ref. 5) applied fracture mechanics to gear teeth to estimate stress intensity factors and gear life. Researchers at Tohoku University in Japan performed a series of analyses and experiments to determine the effect of residual stress on crack initiation and propagation (Refs. 6, 7). Also, Daniewicz et al. (Ref. 8) developed a comprehensive, self-contained analysis package to refine the spur gear bending fatigue theory using fracture mechanics. Lastly, Flasket and Pehan (Ref. 9) described their method for calculating crack propagation in gear teeth using fracture mechanics. Much of the work of the above references considered only an initial crack, and propagation paths were not considered. Many of the references that did consider crack propagation assumed the propagation occurred in a straight path. In addition, experimental validation of the cited analyses was sparse. Finally, no work using fracture

mechanics was performed for thin-rim gears.

The objective of this study was to determine the effect of gear rim thickness on crack propagation life. From an extensive study (Ref. 10), linear elastic fracture mechanics was used to analyze gear tooth bending fatigue in standard and thin-rimmed gears. Finite element computer programs were used to determine stress distributions, estimate stress intensity factors and model crack propagation. Various fatigue crack growth models were used to estimate crack propagation life. Experimental tests were performed to validate predicted crack propagation results.

Fatigue Crack Growth

Many machine elements, such as gear teeth, are cyclically loaded in application. The overall fatigue life of such components may be represented by three distinct phases: 1) crack initiation, 2) crack propagation and 3) final failure. Once crack initiation has occurred, fracture mechanics may be used to estimate crack propagation fatigue growth rate and time to final failure.

The most universally used method to calculate crack propagation crack growth was postulated by Paris and Erdogan (Ref. 11). Purely Mode I loaded specimens subjected to cyclic load were considered. Unstable crack growth such that the stress intensity factor grew with increasing crack size was also considered. Paris postulated that the rate of crack growth with respect to number of stress cycles was a logarithmic relationship with the stress intensity factor range as

$$\frac{da}{dN} = C(\Delta K)^n \quad (1)$$

where da is the change in crack length for dN number of stress cycles, ΔK is the range of the Mode I stress intensity factor at a given time and C and n are material constants. The material constants C and n must be determined by some experimental means.

Further research of fatigue crack growth has shown three important factors not considered in the Paris model. First was the

effect of load ratio R on crack growth ($R =$ minimum cyclic load/maximum cyclic load). Second was the instability of crack growth observed when the stress intensity factor range approached the material's fracture toughness index, K_{IC} . Third was the presence of a stress intensity threshold factor ΔK_{th} . The stress intensity threshold factor is the highest stress intensity factor in which no crack growth would occur. The Collipiest crack growth model (Ref. 12) accounts for these effects where

$$\frac{da}{dN} = C(K_{IC}\Delta K_{th})^{n/2} \cdot$$

$$\exp \left\{ \ln \left(\frac{K_{IC}}{\Delta K_{th}} \right)^{n/2} \cdot \tanh^{-1} \left[\frac{\ln \left(\frac{\Delta K^2}{(1-R)K_{IC}\Delta K_{th}} \right)}{\ln \left(\frac{(1-R)K_{IC}}{\Delta K_{th}} \right)} \right] \right\} \quad (2)$$

In addressing applications to gears, Inoue et al. (Ref. 7) describe fatigue crack growth of gear bending fatigue tests. Here, crack growth equations were derived as a function of crack depth through a gear tooth. The expression derived for crack growth rate da/dN , as a function of stress intensity range ΔK was

$$\frac{da}{dN} = \begin{cases} \frac{\lambda}{(1-\alpha^n)} (\Delta K^n - \Delta K_{th}^n) & \text{for } \Delta K_{th} \leq \Delta K \leq \Delta K_C \\ \frac{\lambda}{(1-\alpha^n)} \frac{\Delta K^n K_{IC}^n}{(K_{IC}^n - \Delta K^n)} & \text{for } \Delta K_C < \Delta K < \Delta K_{IC} \end{cases} \quad (3)$$

where the parameters K_{IC} , α , ΔK_C , ΔK_{th} , η and λ were all estimated as a function of tooth hardness (Ref. 7).

Crack Propagation Simulation

The analysis of the current study used the FRANC (FRacture ANalysis Code) computer program described by Wawrzynek (Ref. 13). FRANC is a general purpose finite element code for the static analysis of cracked structures. FRANC is designed for two-dimensional problems and is capable of analyzing plane strain, plane stress or axisymmetric problems.

Among the variety of capabilities, a unique feature of FRANC is the ability to

model a crack in a structure. FRANC uses a method called "delete and fill" to accomplish this. To illustrate, the user would first define an initial crack by identifying the node of the crack mouth and coordinates of the crack tip. FRANC will then delete the elements in the vicinity of the crack tip. FRANC will next insert a rosette of quarter-point, six-node triangular elements around the crack tip to model the inverse square-root stress singularity (Refs. 14, 15). Finally, FRANC will fill the remaining area between the rosette and original mesh with conventional six-node triangular elements. The user can then run the finite element equation solver to determine nodal displacements, forces, stresses and strains.

A further unique feature of FRANC is the automatic crack propagation capability. After an initial crack is inserted in a mesh, FRANC models a propagated crack as a number of straight line segments. For each segment, FRANC models the crack tip using a rosette of quarter-point elements. FRANC then solves the finite element equations, calculates the stress intensity factors and calculates the crack propagation angle. After the crack propagation angle is determined, FRANC then places the new crack tip at the calculated angle and at a user-defined crack increment length. The model is then remeshed using the "delete and fill" method described above. The procedure is repeated a specific number of times as specified by the user. In the current study, the stress intensity factors were determined from the calculated nodal displacements using the displacement correlation method (Ref. 16). The method of Erdogan and Sih (Ref. 17) was used in the current study to determine the crack propagation angle.

Once the stress intensity factors are determined for each segment, the predicted number of crack propagation cycles can be estimated using the fatigue crack growth models. Regardless of the model used, the crack growth rates da/dN , were of the form

$$\frac{da}{dN} = g(\Delta K) \quad (4)$$

where $g(\Delta K)$ is given by Eq. 1 for the Paris relationship, Eq. 2 for the Collipriest relationship or Eq. 3 for Inoue's method. The predicted number of crack propagation cycles for the i_{th} crack segment, N_p , was estimated by

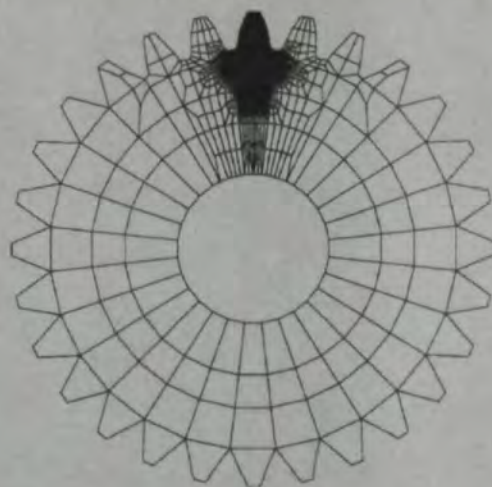

Fig. 1 — Finite element model of gears used in crack propagation studies, solid model, $m_B = 3.3$.

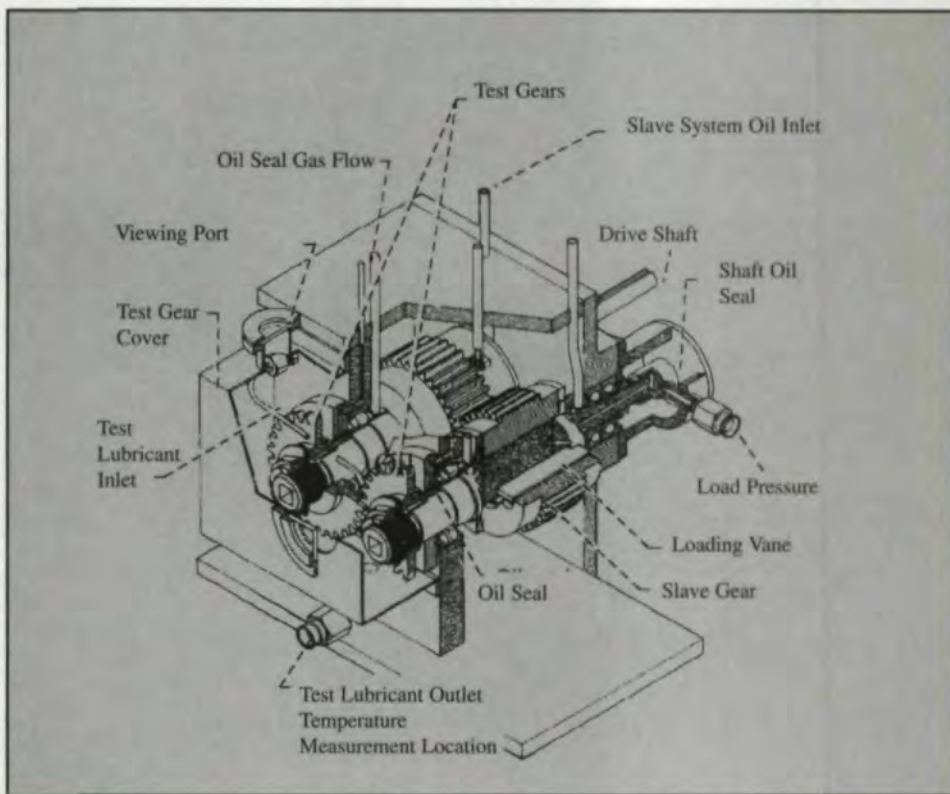

Fig. 2 — NASA Lewis Spur Gear Fatigue Rig.

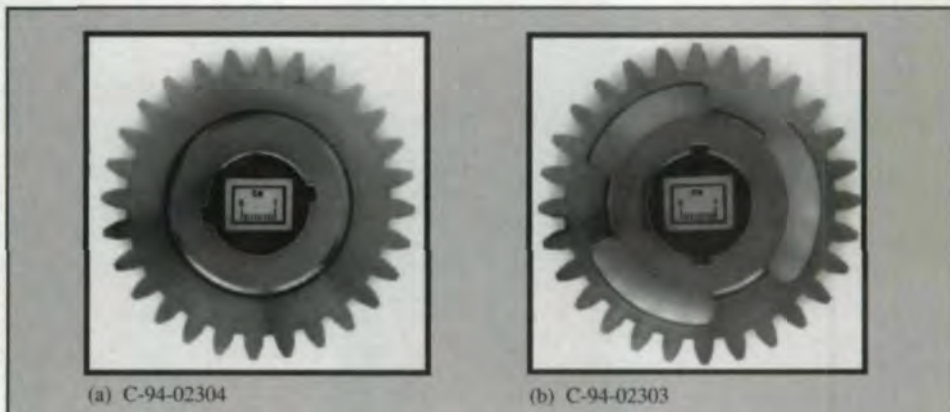

Fig. 3 — Test gears used to determine effect of rim thickness on crack propagation. (a) $m_B = 3.3$, (b) $m_B = 0.3$.

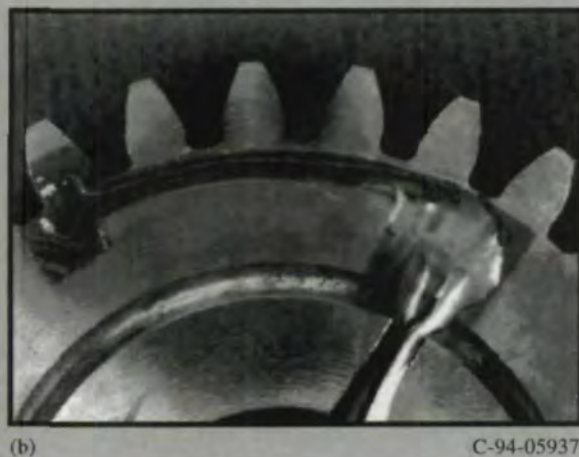
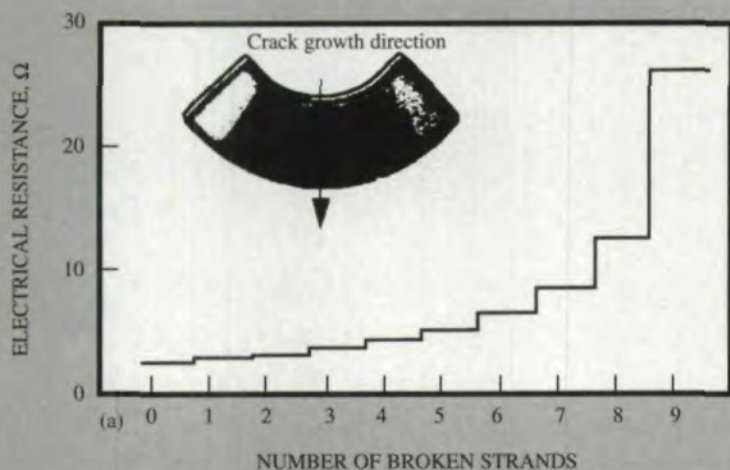

Fig. 4 — Specialized crack propagation gages for gear tooth crack growth measurements. (a) Increase in gage electrical resistance as the number of broken strands increases. (b) Installation of crack propagation gage on test gear.

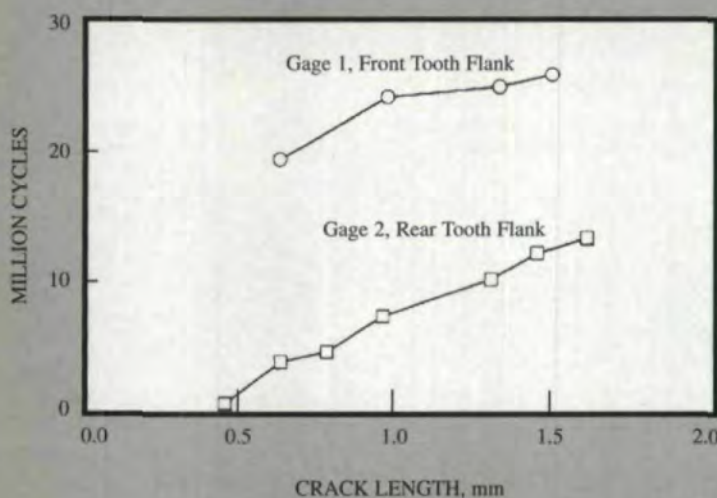

Fig. 5 — Crack propagation fatigue growth for Test 1, $m_B = 0.3$.

$$N_i = \frac{a_i - a_{i-1}}{g(\Delta K_i)} + N_{i-1} \quad (5)$$

where a_i was the crack length of the i_{th} segment, a_{i-1} was the crack length of the $(i-1)_{th}$ segment, N_{i-1} was the number of cycles of the $(i-1)_{th}$ segment and $g(\Delta K_i)$ was the average crack growth rate of the i_{th} and $(i-1)_{th}$ segments. Note that a_1 was the initial crack length, and $N_1 = 0$ and i varied from 2 to the total number of segments.

Gear Finite Element Modeling

Basic gear tooth geometry data was input to a tooth coordinate generation computer program. The tooth coordinate generator program used the method of Hefeng et al. (Ref. 18) to determine the tooth coordinates. The output was tooth coordinate and rim coordinate data which defined a single tooth sector of a gear. This output was used by a commercially available pre- and post-processing finite element analysis software package (Ref. 19). This package created the finite element mesh of the complete gear. FRANC then used this mesh and performed crack propagation simulations.

Fig. 1 shows a sample finite element mesh of an uncracked gear. The tooth geometry used modeled that of the test gears of the NASA Lewis Spur Gear Fatigue Rig (described in the following section). The analysis used 8-node, plane stress, quadrilateral finite elements. The mesh was refined in the region of the loaded tooth for improved accuracy. The model of Fig. 1 had 2,353 elements and 7,295 nodes. Material properties used were that of AISI 9310 steel. The tooth load was placed at the highest point of single tooth contact. For boundary conditions, four hub nodes were fixed. In addition, gears with various rim thicknesses were modeled. The parameter describing the rim thickness was the backup ratio m_B , where

$$m_B = \frac{b}{h} \quad (6)$$

where b was the rim thickness, and h was the tooth whole depth. Gears with various backup ratios were modeled by incorporating slots in the model. All cases used the same finite element mesh for the loaded tooth.

Test Facility

Crack propagation experiments were performed in the NASA Lewis Spur Gear Fatigue Rig (Fig. 2). The test stand operated on a torque regenerative principle in which

torque was circulated in a loop of test gears and slave gears. Oil pressure was supplied to load vanes in one slave gear which displaced the gear with respect to its shaft. This produced a torque on the test gears, slave gears and connecting shafts proportional to the amount of applied oil pressure. A 19 KW (25 hp), variable-speed motor provided speed to the drive shaft using a belt and pulley. The lubricant used for the gears, bearings and loading systems was a synthetic paraffinic oil. The test gear lubricant was filtered through a 5-micron fiberglass filter.

Test Gears

The test gears were 28-tooth, 8-pitch, 20° pressure angle external spur gears with a face width of 6.35 mm (0.25"). The teeth had involute profiles with linear tip relief starting at the highest point of single tooth contact and ending at the tooth tip at an amount of 0.013 mm (0.0005"). All test gears used in the experiments were fabricated and machined from a single batch of material. The test gear material was vacuum-melted, consumable-electrode AISI 9310 steel. The gears were case carburized and ground. The teeth were hardened to a case hardness of R_c 61 and a core hardness of R_c 38. The effective case depth (depth at a hardness of R_c 50) was 0.81 mm (0.032"). Two different test gear designs were considered. The first was a thick-rimmed gear with a backup ratio of $m_B = 3.3$ (Fig. 3a). The second was a thin-rimmed gear which incorporated slots (Fig. 3b). The backup ratio of the thin-rimmed gear was $m_B = 0.3$.

It was believed that tooth bending fatigue cracks would be difficult to initiate based on the load capacity of the test rig. Due to this, notches were fabricated in the fillet region (loaded side) on one tooth of each of the test gears to promote crack initiation. The notches were fabricated using electrical discharge machining (EDM) with a 0.10 mm (0.004") diameter wire electrode. The nominal notch dimensions were 0.20 mm (0.008") in length and 0.13 mm (0.1005") in width along the full face width of the tooth. The notches were located at the same location for both test gears. This location was at a radius of 40.49 mm (1.594") on the fillet, which was the position of the greatest tensile stress for the solid gear ($m_B = 3.30$). The notches produced a stress concentration factor of approximately three as determined using a finite element analysis.

Instrumentation

The standard test rig instrumentation monitored test gear speed, oil load pressure, test gear and slave gear oil pressure and oil temperatures. Also, overall test stand vibration was monitored using an accelerometer mounted on the top housing. In addition to the standard facility vibration sensor, an advanced vibration processing diagnostic system was installed in the test stand to help assist in crack detection. Crack propagation gages were used in the experiments to determine fatigue crack growth. Special gages were fabricated for installation in the tooth fillet region of the test gears. The gages had ten circular strands with an inner radius of 1.52 mm (0.060") and an outer radius of 3.05 mm (0.120") (Fig. 4). The strands were designed to break as the crack propagated through them, which in turn increased the electrical resistance of the gage (Fig. 4a). Fig. 4b shows the installation of a gage in the fillet region of a notched tooth. A gage was installed on each side of the tooth flank for each gear instrumented with crack gages. The electrical resistance of the crack gages was monitored along with the load cycle count to estimate cycles as a function of crack length. The information from the rotating crack gages was transferred through brush-type slip rings. Also, an infrared tach sensor was used to measure number of load cycles.

Measured Gear Fatigue Crack Growth

The thin-rimmed gear was used in Test 1. The test was run at 89 Nm (786 in/lb) torque and 10,000 rpm speed for 6.5 hrs., at which time rim fracture occurred. Fig. 5 plots the number of load cycles as a function of the measured crack length. The crack gage results indicated the crack growth was non-uniform throughout the tooth face width. A crack started on the rear flank of the tooth at the tip of the notch and reached an initial size of 0.46 mm (0.018") at 1,060,000 cycles. The crack continued to propagate through the rear flank, but did not reach the front flank until approximately 2,680,000 cycles. At 2,910,000 cycles, the crack reached a size of 0.64 mm (0.025") on the front flank, but completed propagation through the rear gage by this time. Even though the crack initiation time was not uniform throughout the tooth face width, the crack propagation rate was uniform. This was indicated by the similarity in slopes of the curves in Fig. 5 for Gages 1 and 2.

A Quick and Portable Solution to Your Process Inspection Needs

Model 3500 offers inspection for both center distance and gimbal type checks, and has the repeatability and accuracy of fully automatic inspection machines. This shop floor ready unit can be utilized to verify set-up, or in-process inspection anywhere in a gear manufacturing facility.



The **2200 Series** is a rugged construction and tough finish unit available in both stud

and arbor and column and overarm models. Ideal for on-the-spot quality control at the gear cutting machine - saving repeated trips to the inspection lab for checks on production equipment and tooling.

Find out how we can help you with your gear quality improvement.

ITW Heartland

3401 South Broadway
Alexandria, MN 56308 USA
Phone: 320-762-8782
Fax: 320-762-5260

Visit our website at:
[www.gctel.com/
~itwgears/itwheart.htm](http://www.gctel.com/~itwgears/itwheart.htm)



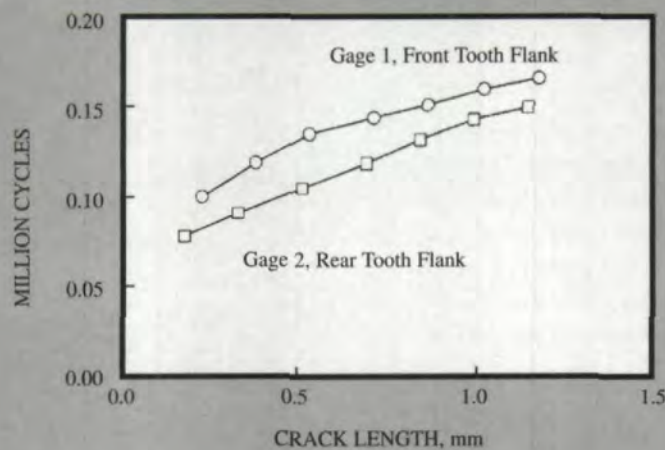

Fig. 6 — Crack propagation fatigue growth for Test 2, $m_B = 3.3$.

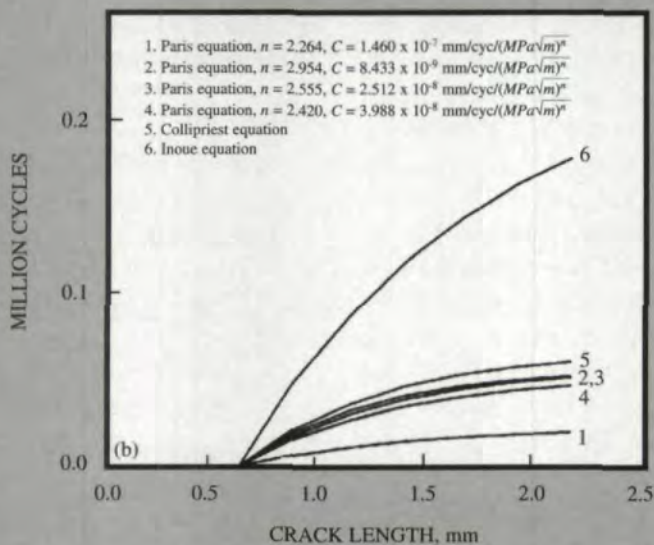
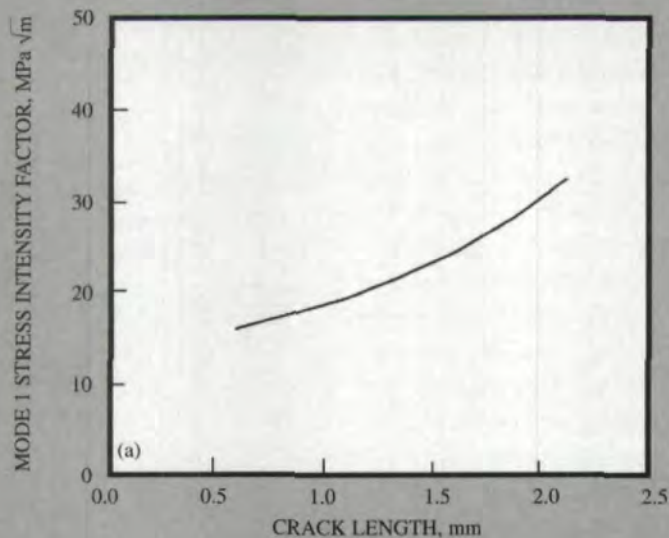

Fig. 7 — Comparison of predicted crack propagation cycles using Paris, Collipriest and Inoue equations. Model for $m_B = 0.3$. (a) Mode I stress intensity factor. (b) Life comparison.

The thick-rimmed gear was used in Test 2. This gear was run at 136 Nm (1200 in/lb) torque and 10,000 rpm speed for 15 minutes, at which time tooth fracture occurred. Fig. 6 gives the processed crack propagation results for Test 2. Note that the crack initiation and crack propagation was fairly uniform throughout the tooth face width for this test.

Comparison of Predicted and Measured Crack Growth

The FRANC computer program was used to simulate crack propagation and calculate Mode I stress intensity factors as a function of crack length. The predicted stress intensity factors were then used with three different fatigue crack growth models (Paris, Collipriest and Inoue) to estimate crack propagation.

A comparison of predicted crack propagation cycles using the Paris, Collipriest and Inoue methods is shown in Fig. 7. For this, the thin-rimmed model ($m_B = 0.3$) was used to simulate the test gear of Fig. 3b. An initial crack of 0.64 mm (0.025") was placed in the tooth fillet at the location of the maximum tensile stress. Crack propagation was then simulated, and the Mode I stress intensity factor as a function of crack length is given in Fig. 7a. From this, six different fatigue growth cases were considered. The first four cases used the Paris equation and material constants of AISI 9310 specimens from experiments of Au and Ke (Ref. 20). The fifth case used the Collipriest equation and AISI 9310 material constants from Forman and Hu (Ref. 21). The load ratio used was $R = 2.6$, as determined from the finite element analysis. The sixth case used Inoue's method and the material constants of the SCM 415 material (SCM 415 is a high-strength Japanese steel with properties similar to AISI 9310). The predicted number of cycles per crack length varied significantly among the cases studied (Fig. 7b). Note that the cycles were defined as the number of crack propagation cycles after an initial crack of 0.64 mm (0.025").

Predicted crack growth for the $m_B = 0.3$ and 3.3 gears was compared to the measured crack growth from the experiments. Again, the six different prediction schemes mentioned above were used. The predicted number of crack propagation cycles using the sixth schemes were, for the most part, extremely low compared to the measured number of cycles from the experiments. To

account for this, the concept of fatigue crack closure was investigated. Elber (Ref. 22) performed crack experiments on aluminum alloys and deduced that residual compressive stresses existed near the crack tip region because of plastic deformation. These residual stresses reduced the effective stress intensity factor range (and thus, increased crack propagation life) and provided a better fit to experimental data than other empirical expressions. Elber proposed an effective stress intensity range ratio U such that

$$\Delta K_{eff} = U(\Delta K) \quad (7)$$

where ΔK_{eff} was the effective stress intensity factor range. Elber then used the effective stress intensity factor range in the Paris fatigue crack growth model. In addition, Elber defined U through experimental studies as a linear function of the load ratio R .

The concept of fatigue crack closure was applied to the current gear crack experiments and predictions. A study was conducted to estimate the effective stress intensity factor range ratio for the experiments. The predicted number of crack propagation cycles using the same six schemes were plotted versus crack length at a variety of arbitrarily chosen U ratios. For the Paris equation and material constants $n = 2.954$ and $C = 8.433 \times 10^{-9} \text{ mm/cyc}/(\text{MPa}\sqrt{\text{m}})^n$, good correlation between predicted crack cycles and the experiments occurred when: 1) $U = 0.4$ for $R = 2.6$, and 2) $U = 0.8$ for $R = 0.1$. Assuming a linear relation between U and R produced

$$U = 0.82 + 0.16(R) \quad (8)$$

Fig. 8 shows a sample comparison of predicted and measured crack growth when the fatigue crack closure concept was used. The cycles were defined as the number of crack propagation cycles after an initial crack of 0.64 mm (0.025"). It should be noted that good correlation was also achieved when the Collipriest equation was used with certain U values. This produced a relationship similar to Eq. 8, but with different coefficients (Ref. 10).

Fig. 9 displays the effect of rim thickness on predicted Mode I stress intensity factors and predicted crack propagation cycles. The stress intensity factors were determined from FRANC using the appropriate finite

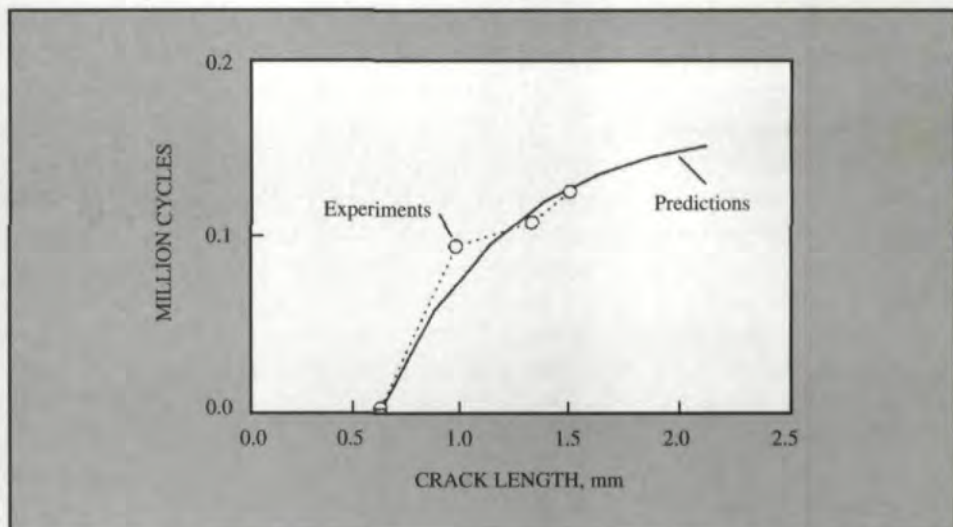

Fig. 8 — Comparison of predicted crack propagation cycles to experiments. Paris fatigue crack growth model, $n = 2.954$, $C = 8.433 \times 10^{-9} \text{ mm/cyc}/(\text{MPa}\sqrt{\text{m}})^n$, $R = -2.6$, $U = 0.4$, used for predictions. Test 1, Gage 1, front flank, for experiments.

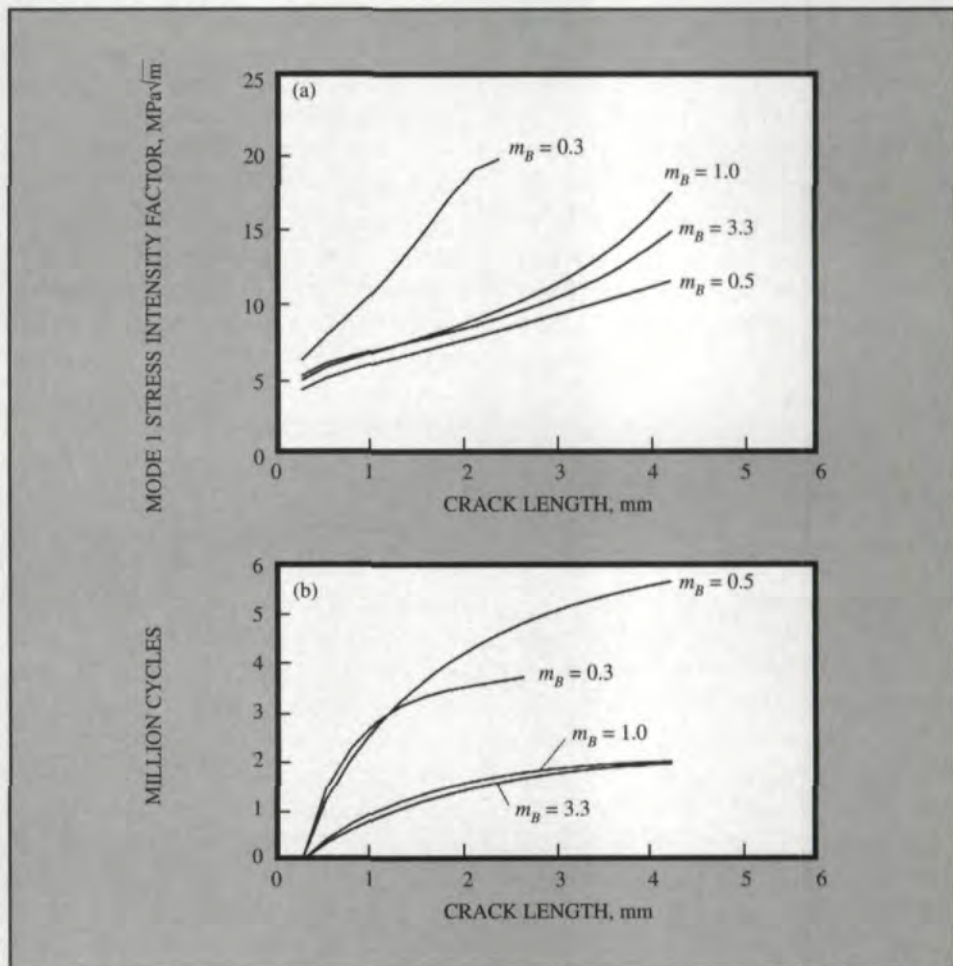

Fig. 9 — Effect of backup ratio on stress intensity factors and crack propagation cycles. (a) Mode I stress intensity factors. (b) Crack propagation cycles, Paris fatigue crack growth model, $n = 2.954$, $C = 8.433 \times 10^{-9} \text{ mm/cyc}/(\text{MPa}\sqrt{\text{m}})^n$, $U = 0.82 + 0.16 R$.

element models. The Paris equation was used along with the effective stress intensity range ratios of Eq. 8. The initial cracks of the various models were placed at the location of the maximum tensile stress in the tooth fillet. The stress intensity factors were lowest for the $m_B = 0.5$ case. This gave the

highest predicted number of cycles for the cases studied. The cycles were all defined as the number of crack propagation cycles after an initial crack of 0.28 mm (0.011"). The stress intensity factors were highest for the $m_B = 0.3$ case. However, the predicted life for this was somewhere between the case of

$m_p = 0.5$ and 1.0 due to the fatigue crack closure effect. The cases of $m_p = 3.3$ and 1.0 gave nearly the same predicted life.

Conclusions

Based on these analytical and experimental studies, the following conclusions were made: 1) Good correlation between predicted and measured gear crack growth was achieved when the predictions used the Paris crack growth equation and the concept of fatigue crack closure. 2) For thin rims, a decrease in rim thickness caused an increase in both the stress intensity factor and the compressive cyclic stress in the gear tooth fillet region. The increase in stress intensity factor promoted crack growth, while the increase in cyclic compressive stress tended to retard crack growth and increase the number of propagation cycles to failure. ⚙

Acknowledgments: The authors wish to thank Dr. Paul A. Wawrzynek of Fracture Analysis Consultants, Inc., for fruitful discussions and for providing the FRANC program.

Prepared for An Integrated Monitoring, Diagnostics & Prevention Technology Showcase, Society for Machinery Failure Prevention Technology, Mobile, AL, April 22-26, 1996.

References:

1. "Fundamental Rating Factors and Calculation Methods for Involute Spur and Helical Gear Teeth." ANSI/AGMA 2001-B88, American Gear Manufacturers Association, Alexandria, VA, 1990.
2. Drago, R. J. and R. V. Lutthans. "Combined Effects of Rim Thickness and Pitch Diameter of Spur Gear Tooth Stresses." *Journal of the American Helicopter Society*. Vol. 28, July, 1983, pp. 13-19.
3. Ahmad, J. and F. T. Loo. "On the Use of Strain Energy Density Fracture Criterion in the Design of Gears Using Finite Element Method." ASME Paper No. 77-DET-158. Presented at the Design Technical Conference, Chicago, IL, Jun., 1977.
4. Honda, H. and J. C. Conway. "An Analysis by Finite Element Techniques of the Effects of a Crack in the Gear Tooth Fillet and Its Applicability to Evaluating Strength of the Flawed Gears." *Bulletin of the JSME*, Vol. 22, No. 174, Dec., 1979, pp. 1848-1855.
5. Flasker, J. and A. Jezernik. "The Comparative Analysis of Crack Propagation in the Gear Tooth." *Proceedings of the Int.*

Conf. of Application of Fracture Mechanics to Materials and Structures, Freiburg, Germany, June, 1983. pp. 971-982.

6. Kato, M. et al. "Strength Evaluation of Carburized Gear Teeth Based on Fracture Mechanics." *Proceedings of the KSME/JSME Joint Conference "Fracture and Strength '90"*, Seoul, Korea, 1990, pp. 248-253.

7. Inoue, K. et al. "Fracture Mechanics Based Evaluation of Strength of Carburized Gear Teeth." *Proceedings of the JSME International Conference on Motion and Power Transmissions*. Hiroshima, Japan, Nov., 1991, pp. 801-806.

8. Daniewicz, S. R. et al. "The Stress Intensity Factor and Stiffness for a Cracked Spur Gear Tooth," *Journal of Mechanical Design*, Vol. 116, No. 3, Sept., 1994.

9. Flasker, J. and S. Pehan. "Crack Propagation in Tooth Root with Variable Loading." *Communications in Numerical Methods in Engineering*, Vol. 9, No. 2, Feb., 1993, pp. 103-110.

10. Lewicki, D. G. "Crack Propagation Studies to Determine Benign or Catastrophic Failure Modes for Aerospace Thin-Rim Gears." Ph.D. Dissertation, Case Western Reserve University, May, 1995.

11. Paris, P. C. and F. Erdogan. "A Critical Analysis of Crack Propagation Laws." *Journal of Basic Engineering*, Vol. 85, 1963, pp. 528-534.

12. Collipriest, J. E. "An Experimentalist's View of the Surface Flaw Problem." *The Surface Crack: Physical Problems and Computation Solutions*, American Society of Mechanical Engineers, 1972, pp. 43-61.

13. Wawrzynek, P. A. "Discrete Modeling of Crack Propagation: Theoretical Aspects and Implementation Issues in Two and Three Dimensions." Ph.D. Dissertation, Cornell University, 1991.

14. Henshell, R. D. and K. G. Shaw. "Crack Tip Finite Elements Are Unnecessary." *International Journal for Numerical Methods in Engineering*, Vol. 9, 1975, pp. 495-507.

15. Barsoum, R. S. "On the Use of Isoparametric Finite Elements in Linear Fracture Mechanics." *Journal for Numerical Methods in Engineering*, Vol. 10, No. 1, 1976, pp. 25-37.

16. Tracey, D. M. "Discussion of 'On the Use of Isoparametric Finite Elements in

Linear Fracture Mechanics' by R. S. Barsoum." *International Journal for Numerical Methods in Engineering*, Vol. 11, 1977, pp. 401-402.

17. Erdogan, F. and G. C. Sih. "On the Crack Extension in Plates Under Plane Loading and Transverse Shear." *Journal of Basic Engineering*, Vol. 85, 1963, pp. 519-527.

18. Hefeng, B. et al. "Computer Modeling of Rack-Generated Spur Gears." *Mechanism and Machine Theory*, Vol. 20, No. 4, 1985, pp. 351-360.

19. *P3/PATRAN User Manual*. PDA Engineering, Costa Mesa, CA, 1993.

20. Au, J. J. and J. S. Ke. "Correlation Between Fatigue Crack Growth Rate and Fatigue Striation Spacing in AISI 9310 Steel." *Fractography and Materials Science*, ASTM STP 733, 1981, pp. 202-221.

21. Forman, R. G. and T. Hu. "Application of Fracture Mechanics on the Space Shuttle." *Damage Tolerance of Metallic Structures*, ASTM STP 842, 1984, pp. 108-133.

22. Elber, W. "The Significance of Fatigue Crack Closure." *Damage Tolerance in Aircraft Structures*, ASTM STP 486, 197, pp. 230-242.

David G. Lewicki

is with the Vehicle Technology Center, U.S. Army Research Laboratory, Lewis Research Center, Cleveland, OH.

Roberto Ballarini

is in the Dept. of Civil Engineering and Mechanical & Aerospace Engineering, Case Western Reserve University, Cleveland, OH.

Tell Us What You Think . . .

If you found this article of interest and/or useful, please circle 204.

For more information about NASA Lewis Research Center, circle 205.

At SDP/SI
we design, cut, turn, mill, hob,
mold, stock and ship
millions of drive components



...and we price them right.

At Stock Drive Products/Sterling Instrument – SDP/SI for short – we not only live up to our promise, we go beyond: In addition to offering over 62,000 products shippable within 24 hours from inventory we can handle the most challenging custom drive components. And we just added a whole new gear manufacturing plant to our extensive ISO 9001 certified TQM facilities. Go ahead, put us to the test. Ask for our FREE 6-volume catalog “library” or the new CD-ROM on timing belt drives.



ISO 9001

Simply fax: 1-800-SDP-SI36 (1-800-737-7436)

<http://www.sdp-si.com>

SDP/SI
Superior Drive Products / Shipped from Inventory



2101 Jericho Tpke., Box 5416
New Hyde Park, NY 11042-5416
Phone: 516-328-3300

Gear Shaving Basics – Part I

John P. Dugas

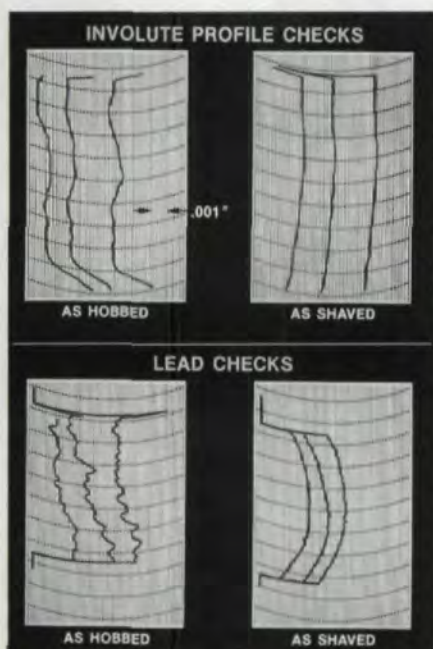

Fig. 1 — Charts showing improvement in profile and lead, 5.7 NPD, 20°, NPA, 3.85" P.D., crowned shaved with stock removal of 0.011" over pins.

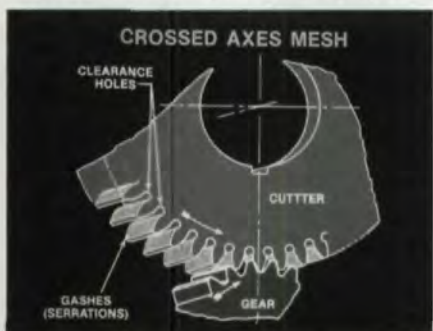

Fig. 2 — Work gear in crossed-axes mesh with rotary shaving cutter mounted above.

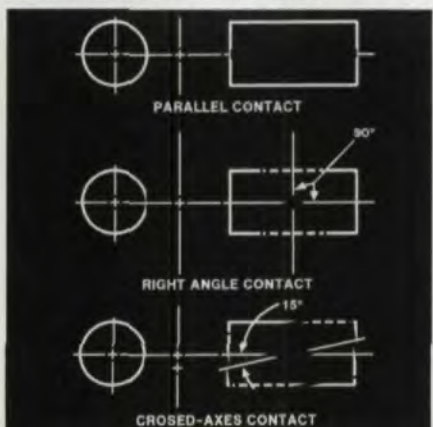

Fig. 3 — Contact between cylinders change as crossed axes are varied.

Gear shaving is a free cutting gear finishing operation which removes small amounts of metal from the working surfaces of gear teeth. Its purpose is to correct errors in index, helix angle, tooth profile and eccentricity (Fig. 1). The process also improves tooth surface finish and eliminates by means of crowned tooth forms the danger of tooth end load concentrations in service. Shaving provides for profile modifications that reduce gear noise, increase a gear's load carrying capacity, its factor of safety and its service life. Gear finishing (shaving) is not to be confused with gear cutting (roughing). They are essentially different. Any machine designed primarily for one cannot be expected to do both with equal effectiveness or with equal economy.

Gear shaving is the logical remedy for the inaccuracies inherent in gear cutting. It is equally effective as a control for those troublesome distortions caused by heat treatment.

The form of the shaving cutter can be reground to make profile allowance for different heat treat movements caused by varying heats of steel. The shaving machine can also be reset to make allowance for lead change in heat treatment.

Rotary gear shaving is a production process that utilizes a high speed, hardened and ground, ultra-precision steel shaving cutter. The cutter is made in the form of a helical gear. It has gashes in the flanks of the teeth which act as the cutting edges.

The cutter is meshed with the work gear in a crossed-axes relationship (Fig. 2) and rotated in both directions during the work cycle while the center distance is reduced in small increments. Simultaneously the work is traversed back and forth across the width of the cutter. The traverse path can either be parallel or

diagonal to the work gear axis, depending on the type of work gear, the production rate and finish requirements. The gear shaving process can be performed at high production rates. It removes material in the form of fine hair-like chips.

Machines are available to shave external spur and helical gears up to 200" in diameter. Other machines are also available for shaving internal spur and helical gears. For best results with shaving, the hardness of the gear teeth should not exceed 30 Rockwell C scale. If stock removal is kept to recommended limits, and the gears are properly qualified, the shaving process will finish gear teeth in the 7 to 20 pitch range to the following accuracies: involute profile, 0.0002"; tooth-to-tooth spacing, 0.0003" and lead or parallelism, 0.0002".

In any event, it should be remembered that gear shaving can remove 65–80% of the errors in a hobbed or shaped gear. It will make a good gear better. The final quality of the shaved gear is dependent to a large degree upon having good hobbed or shaped gear teeth.

Excellent surface finish is achieved with gear shaving. A value of approximately 25^o is the normal finish obtained with production gear shaving, although much finer finishes are possible by slowing the process. In some cases, shaving cutters will finish up to 80,000 gears before they need sharpening. They may generally be sharpened from four to ten times.

To a gear designer, the shaving process offers attractive advantages in the ability to modify the tooth form. If a crowned tooth form or a tapered tooth form are desired to avoid end bearing conditions, these can be easily provided by shaving.

If modifications are desired in the involute profile, these can be made by suitable modifications in the ground cutter tooth form. If heat treatment distur-

GEAR FUNDAMENTALS

tions can be kept to a minimum, the most inexpensive way to produce an accurate, quiet, high-performance gear is to specify hobbing followed by gear shaving. The shaving process uses a variety of standardized production equipment ranging from hand loading to fully automatic loading and unloading.

Basic Principles

The rotary gear shaving process is based on fundamental principles. This process uses a gashed rotary cutter in the form of a helical gear having a helix angle different from that of the gear to be shaved. The axes of the cutter and the gear are crossed at a predetermined angle during the shaving operation. When the cutter and the work gear are rotated in close mesh, the edge of each cutter gash shaves a fine hair-like chip as it moves over the surface of a work gear tooth. The finer the cut, the less the pressure required between tool and work, eliminating the tendency to cold-work the surface metal of the work gear teeth.

This process is performed in a shaving machine, which has a motor-driven cutter head and a reciprocating work table. The cutter head is adjustable to obtain the desired crossed axis relationship with the work. The work carried between live centers is driven by the cutter. During the shaving cycle, the work is reciprocated parallel to its axis across the face of the cutter and upfed an increment into the cutter with each stroke of the table. This conventional shaving cycle is one of several methods.

The Crossed-Axis Principle

To visualize the crossed-axis principle, consider two parallel cylinders of the same diameter (Fig. 3). When brought together under pressure, their common contact surface is a rectangle having the length of a cylinder and width which varies with contact pressure and cylinder diameter.

When one of these cylinders is swung around so that the angle between its axis and that of the other cylinder is increased up to 90°, their common plane remains a parallelogram, but its area steadily decreases as the axial angle increases. The same conditions prevail when instead of the two plain cylinders, a shav-



PERFORMANCE & QUALITY

- AEROSPACE SPLINES
- HELICAL SHAPING
- CROWN SHAPING
- CNC SHAPING
- FACE GEARS
- GEAR HOBBIING
- SPLINE HOBBIING
- KEYSEATING
- CNC TURNING
- CNC MACHINING
- HELICAL BROACHING
- STRAIGHT BROACHING
- COMPLETE MACHINE SHOP
- EXOTIC ALLOY MACHINING
- GEAR INSPECTION SERVICES
- PROTOTYPE GEARS WITH FAST DELIVERY
- TOOTH CUTTING ONLY OR COMPLETE TO PRINT

PERRY

TECHNOLOGY CORPORATION
P.O. Box 21 / 29 Industrial Park Road
New Hartford, CT. 06057
Phone: (860) 738-2525
Fax: (860) 738-2455

CONTACT US FOR A PROMPT QUOTATION.
YOU'VE FOUND: THE GEAR & SPLINE EXPERTS

CIRCLE 146

GEAR SHAPER CUTTERS

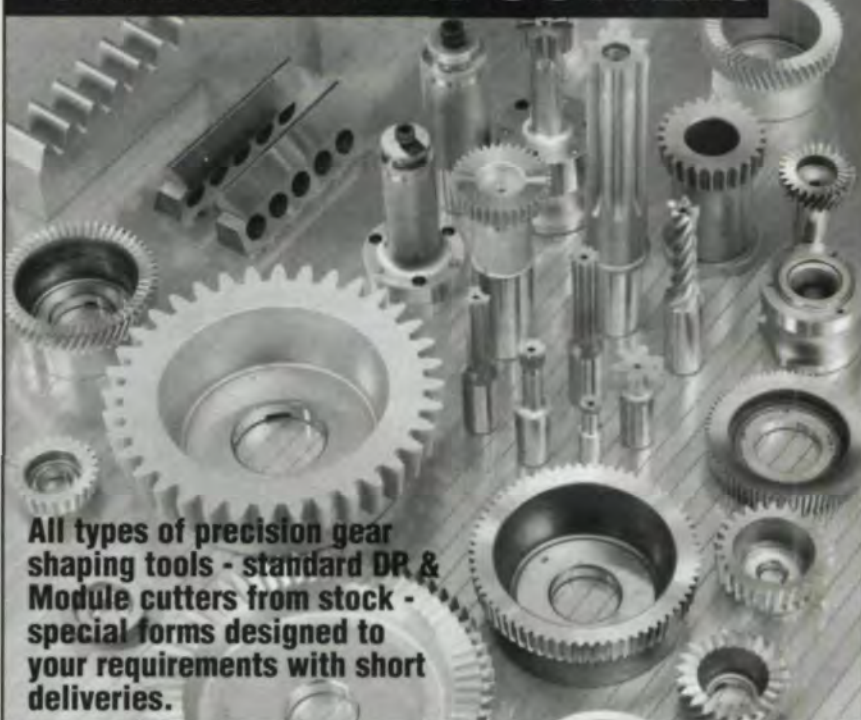

All types of precision gear shaping tools - standard DR & Module cutters from stock - special forms designed to your requirements with short deliveries.

Also Hobs, Master Gears & Spline Gages.



PARKER
INDUSTRIES INC.

1650 Sycamore Ave., Bohemia, NY 11716 • 1-516-567-1000 • Fax: 1-516-567-1355

CIRCLE 168

ing cutter and a work gear are meshed together. When the angle between their axes is from 10° to 15°, tooth surface contact is reduced, and the pressure required for cutting is small. As the work gear is moved away axially from the point of intersection of the axes, backlash develops. Conversely, as it is returned to the point of axial intersection, backlash decreases until the two members engage in tight mesh with the teeth of the cutter wedging between those of the work gear. Thus, each succeeding cutting edge sinks deeper into the work gear tooth until the point of axial intersection is reached.

For shaving, the cutter and work gear axes are crossed at an angle usually in the

range of 10° to 15° or approximately equal to the difference in their angles.

Crossing the axes produces reasonably uniform diagonal sliding action from the tip of the teeth to the root. This not only compensates for the nonuniform involute action typical of gears in mesh on parallel axes, but provides the necessary shearing action for stock removal.

Relationship Between Cutting & Guiding Action

Increasing the angle between the cutter and work axes increases cutting action, but, as this reduces the width of the contact zone, guiding action is sacrificed. Conversely, guiding action can be increased by reducing the angle of

crossed axes, but at the expense of cutting action.

Preparation Prior to Shaving

The first consideration in manufacturing a gear is to select the locating surfaces and use them throughout the process sequence. Close relationship between the locating surface and the face of the gear itself must be held. Otherwise, when the teeth are cut and finished with tooling that necessarily contacts the gear faces, the teeth will be in an improper relationship with the locating or related surface on which the gear operates. Gears that locate on round diameters or spline teeth must fit the work arbors closely or these critical hole-to-face relationships will be destroyed.

Typical manufacturing tolerances for gear blanks prior to cutting of the teeth are shown in Table 1.

Once the gear blank has been manufactured, it is necessary to cut the gear teeth. The most common methods today for rough-cutting gear teeth are hobbing and shaper cutting. Of primary concern to the shaving cutter manufacturer is the fillet produced by the roughing operation. The tips of the shaving cutter teeth must not contact the gear root fillet during the shaving operation. If such contact does occur, excessive wear of the cutter results, and the accuracy of the involute profile is affected.

The shaving cutter just finishes the gear tooth below its active profile. Thus, the height of the fillet should not exceed the lowest point of contact between the shaving cutter teeth and the teeth on the work gear.

Protuberance type hobs and shaper cutters are often used prior to shaving to produce a slight undercut or relief near the base of the gear tooth. This method assures a smooth blending of the shaved tooth profile and the unshaved tooth fillet, as well as reducing shaving cutter tooth tip wear (Fig. 4). The amount of undercut produced by the protuberance type tool should be made for the thin end of the tooth. The position of the undercut should be such that its upper margin meets the involute profile at a point below its contact diameter.

BUILDING ON EXCELLENCE...

Quality Is A Constant
Introducing two new products that will enhance your production capabilities and improve product delivery.

NEW
CNC Grinders (Vertical)

NEW U-Axis
U-Axis Machining Centers (Horizontal and Vertical)

NEW
CNC Gear Hobbers and Hob Sharpeners

CNC Turning/Mill - Turn Center

IKEGAI
IKEGAI AMERICA CORPORATION
2246 North Palmer Drive, Suite 108
Schaumburg, Illinois 60173
TEL (847) 397-3970 FAX (847) 397-7535

Dealers Inquiries Welcome

CIRCLE 124



In This Dog Eat Dog World...

...**P**roductivity and efficiency are everything. You need hobs that perform with superior accuracy and efficiency. You need hobs you can rely on, day after day, to maintain maximum productivity. You need LMT-Fette hobs.

For almost a century, LMT-Fette hobs have provided a competitive advantage. Engineered to meet your specific manufacturing requirements, LMT-Fette hobs produce the highest quality gears at the fastest possible rate. And LMT-Fette hobs are so precise, efficient and free cutting, they reduce wear and tear on your machines, provide longer tool life and minimal down-time. In other words, they'll take a **big bite** out of operating costs!

LMT-Fette offers a wide variety of productivity-enhancing hobs, including:

Solid Carbide Hobs for Dry Machining

- Maximum Speed and Productivity
- Cleaner Shop, Parts and Environment

Heavy Duty Roughing and Finishing Hobs

- 2-3 Times Faster than Conventional Hobs
- Staggered Teeth for Smoother Operation

Indexable Carbide Insert Hobs

- Reduced Downtime by Exchanging Pre-set Segments on Machine
- Carbide Insert Grades to Match Gear Material
- No Resharpener

Skive Hobs for Hardened Gears

- Removes Distortion Faster than Grinding
- Use as Pre-grinding Hobs to Reduce Grinding Time

Gash Master Hobs with the Most Gashes Available

- Faster, More Productive Cycle Times

Gear Gashing Cutters

- Rough Machining of Large Gears
- With Bore or End Mill Style

Resharpener Services Available



Call your local
authorized

LMT • FETTE
distributor!

LEITZ METALWORKING TECHNOLOGY GROUP

BÖHLERIT • FETTE • KIENINGER

3725-I N. 126TH ST., BROOKFIELD, WISCONSIN 53005 • PHONE: 800-225-0852 • FAX: 414-783-5043
CIRCLE 104

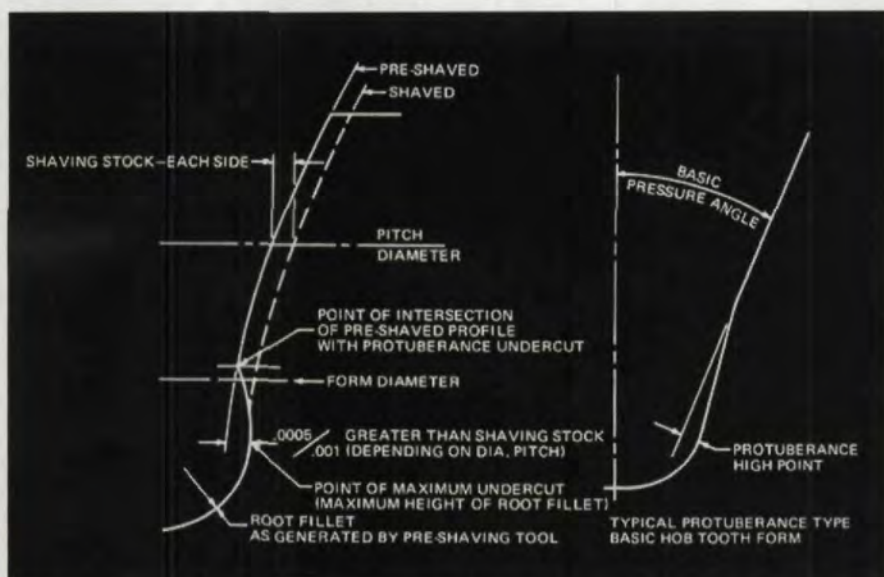

Fig. 4 — Undercut produced by protuberance hob and basic hob tooth form.

TABLE 1 — TYPICAL GEAR BLANK TOLERANCE

Blank Dia. In.	Face Runout In.	Hole Size In.	Hole Tape In./In.	Hole Roundness In.-Max.	O.D. In.-Max.	O.D. Runout In.
Up to 1	0.0003—	0.0003—	0.0002—	0.0002—	0.003	0.003
1-in Thick	0.0005	0.0006	0.0003	0.0003		
1-4, up to 1 in.	0.0004—	0.0005—	0.0002—	0.0003—	0.005	0.005
Thick	0.0008	0.001	0.0003	0.0005		
4 to 8	0.0006— 0.0012	0.0008— 0.0012	0.0002— 0.0003	0.0004— 0.0006	0.005	0.007
8 to 12	0.001— 0.002	0.001— 0.0015	0.0002— 0.0003	0.0005— 0.0007	0.005	0.008

TABLE 2 — RECOMMENDED SHAVING STOCK AND UNDERCUT FOR PRESHAVED GEARS.

Normal Diametral Pitch	Shaving Stock (In. per Side of Tooth)	Total Undercut (In. per Side of Tooth)
2-4	0.0015-0.0020	0.0025-0.0030
5-6	0.0012-0.0018	0.0023-0.0028
7-10	0.0010-0.0015	0.0015-0.0020
11-14	0.0008-0.0013	0.0012-0.0017
16-18	0.0005-0.0010	—
20-48	0.0003-0.0008	—
52-72	0.0001-0.0003	—

Shaving Stock

The amount of stock removed during the shaving process is a key to its successful application. Sufficient stock should be removed to permit correction of errors in the preshaved teeth. However, if too much stock is removed, cutter life and part accuracy are effectively reduced.

Table 2 shows the recommended amounts of stock to be removed during the shaving operations and the corresponding amount of undercut required. ⚙

Acknowledgement: Presented by National Broach & Machine at the Society of Manufacturing Engineers 1st International Advanced Gear Processing & Manufacturing Conference, June, 1996.

The second half of this article, covering shaving methods and design, will appear in our Jan/Feb, 1998, issue.

John P. Dugas

for many years was the Chief Tool Engineer at National Broach & Machine. He is the author of numerous papers and presentations on gear subjects. He is now retired.

Tell Us What You Think . . .

If you found this article of interest and/or useful, please circle 206.

For more information about National Broach & Machine, please circle 207.

BUYING OR SELLING GEARS?

LOG ON HERE

www.powertransmission.com

TECHNICAL CALENDAR

Nov. 9-11. AGMA Fall Technical Meeting. U. S. Grant Hotel, San Diego, CA. Presentations on a variety of gear subjects by experts from around the world. Main topic groups include Advanced Gear Metrology, Alternate Stress Analysis Methods, Application and Technology and Innovations in Design & Manufacturing. For more information, contact AGMA at 703-684-0211, fax 703-684-0242, e-mail agma@clark.net or log on to www.agma.org.

Dec. 8-11. Pfauter Gear School: Basic Course. Rockford, IL. This comprehensive four-day program consists of a coordinated series of lectures by the American Pfauter/Pfauter-Maag staff. Subjects covered include gear types, ratios, involute geometry, gear tooth systems, steels, gear cutting basics, gear inspection and more, plus a tour of the Pfauter facilities. Class size is limited, so be sure to register early. Call 815-282-3000 x313, fax 815-282-3075 or register online at www.pfauter.com.

March 16-19, 1998. National Manufacturing Week. McCormick Place, Chicago, IL. Billed as covering "the hottest topics in manufacturing," this week-long exhibition and conference will feature over a half-million sq. ft. of exhibit space for some 65,000 visitors. The conference will offer 15 tracks in three different formats. Among the subjects covered will be 21st Century Manufacturing, CAD/CAM, Data Acquisition, Design for Manufacturability, Integrated Manufacturing Technology, Environmental/Safety, World Class Maintenance and Materials & Processes. For more information, contact Reed Exhibition Companies at 800-840-0678, fax 203-840-9678, e-mail nmw@reedexpo.com or log on to <http://nmw.reedexpo.com>.

April 22-27, 1998. Seoul International Machine Tool Show 98. Seoul Yoido Exhibition Center and Yoido Tongil Exhibition Center. Organized by the Korea Machine Tool Manufacturers' Association and sponsored by the Korean Ministry of Trade, Industry & Energy, this show is designed to promote international trade through the international exchange of information and technology. Both domestic and foreign machine tools and related items will be featured. For more information about exhibiting or attending, contact Korea Machine Tool Manufacturers' Association by phone at 82-2-565-2721 or fax 82-2-564-5639.

CALL FOR PAPERS

The Product Design & Development Division of the Society of Plastics Engineers and the Plastics Steering Committee of the Emerging Technologies of AGMA is planning one to two sessions on **Plastics Gearing Technology** to be held at ANTEC '98 in Atlanta, GA, **April 26-May 1, 1998**. The theme of ANTEC '98 is "Plastics on My Mind," and papers on any subject relevant to promoting and improving plastic gearing technology is welcome. Deadline for papers is **November 10, 1997**. For more information, contact Andrea Knapp at SPE Headquarters, 203-740-5458 or fax 203-775-8490. ☉

Tell Us What You Think . . .

If you found this article of interest and/or useful, please circle 215.

QUALITY THAT IS BEYOND PRECISION

Apache AH-64 Main Rotor Transmission



52 years of excellence in flight-critical aerospace components, manufacturing AGMA 14 quality gears and pinions.

In-house multi-axis CNC/DNC machining, CAD/CAM center, computerized testing, metallurgical analysis. Purdy is compliant with MIL-Q-9858A and Boeing D1-9000.

The Purdy Corporation • 586 Hilliard Street
Manchester, CT 06040
Tel: (860) 649-0000 Fax: (860) 645-6293
www.purdytransmissions.com

CIRCLE 150

EXACT & REPEATABLE GEAR DATA

TRUE PITCH DIAMETER
TOTAL INDICATED READOUT
TRUE POSITION
CONCENTRICITY
ALL IN ONE GAUGE



No set-up or master required. PC based SPC program available or RS-232 port. Precision Tungsten Carbide balls or pins for maximum accuracy. Robust construction—Each gauge custom built. Over/under digital display w/ inch or mm conversion.

PHONE OR FAX FOR BROCHURE OR DEMO

DIGITAL
INTERFACE
GEAR
INSPECTION
TERMINAL

DIGIT

Member of AGMA

P.O. Box 367 • Springboro, OH 45066 • Fax: 513/746-5103
Phone: 513/746-3800 • E-mail: digit@erinet.com

CIRCLE 157

The World rotates with Holroyd Screw Technology

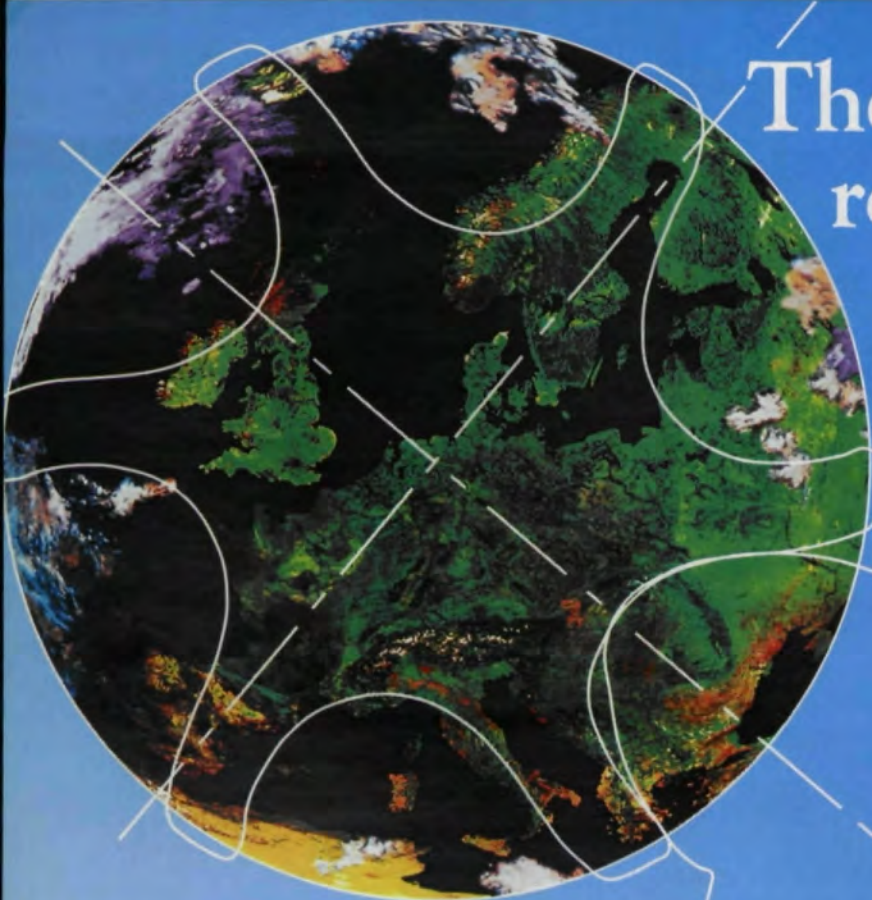

- TG350E CNC Thread Grinding Machine
- Advanced Thread Milling Centres
- Complete Tool Profile Management
- Advanced Measurement Systems
- Tool Design Software
- Conturo-Automatic Deburring Centre
- Sub-Contract Rotor and Worm Gear Manufacturing Facility



Intl. Headquarters: Harbour Lane North,
Milnrow, Rochdale OL16 3LQ. England

Telephone: (44) 01706 526590

Telex: 635772 Holryd G Fax: (44) 01706 353350

USA Office: RLH Associates, Inc., P.O. Box 807.3302 Hwy. 74 West Unit C, Monroe, NC 28111

Telephone: (704) 282-4895 Fax: (704) 289-9147

HOLROYD – The Renold Centre of Excellence

CIRCLE 121



PRODUCTS & SERVICES INDEX

Welcome to the 1998 *Gear Technology* Buyers Guide Product & Services Index. Use this index to locate the names of companies according to the products and services they provide. The complete mailing address, phone and fax numbers and e-mail and Web site addresses of each company are listed in the Company Index. *Gear Technology* advertisers are shown in boldface type. To find the pages on which their ads appear, see the Advertisers Index on page 68.

While we have made every effort to ensure that company names and addresses are correct, we cannot be held responsible for errors of fact or omission.

If your company is not listed and you would like to be included in next year's directory, e-mail people@geartechnology.com, call 847-437-6604, or fax 847-437-6618, and we will add you to our mailing list.

GEAR & DRIVE MANUFACTURERS

Differentials

Bevel Gears (India)
Engelhardt Gear Co.
Euclid Universal Corp.
Fleet Tools Ltd.
Gajra Gears Ltd.
Grupos Diferenciales
ITW Spiroid
Indiana Power
Transmission Systems
Nissei Corp. of America
Sri Venkateshwara Gear

Gear Boxes, Gear Drives & Speed Reducers

ACR Industries
ATA Gears Inc.
Adobe Precision Gear, Inc.
Advance Gear & Machine
Aero Gear, Inc.
Allied Devices Corp.
Alpha Gear Drive, Inc.
Amarillo Gear Co.-Amarillo
Amarillo Gear
Co.-Russellville
American Metric Corp.
Andantex USA
Anderson International
Aplus Engineering Inc.
Arrow Gear Co.
Ashot Ashkelon Indust.
Ashot USA Inc.
Axicon Technologies
Bevel Gears (India)
Bison Gear & Engineering
Blanchat Machine Co.
Bonfiglioli Riduttori
Bonfiglioli U.K.
Boston Gear
C-B Gear & Machine, Inc.
CMD (UK) Ltd.
Calicut Eng. Works Ltd.
Channel Power
Transmission, Inc.
Charles Bond Co.
Chicago Gear-D. O. James
Ciateq, A. C.
The Cincinnati Gear Co.
Circle Gear & Machine
Columbia Gear Corp.
Cone Drive Operations
Curtis Machine Co. Inc.
Cyclo Transmissions Ltd.
Davall Gear Co. Ltd.
Dayton Gear & Tool
Delroyd Worm Gear
Dynamic Tool Grinding
Electra-Gear
Engelhardt Gear Co.
Engranes Industriales
Rivera
Euclid Universal Corp.

Fairfield Mfg. Co.
Falk Corp.
Fleet Tools Ltd.
Flender Corporation
Flender-Graffenstaden
Foote-Jones/Illinois Gear
GW Plastics
Gajra Gears Ltd.
Gear Products Inc.
Gear Systems Inc.
The Gear Works-Seattle
Gears & Drive Systems
Geartronics Industries
Great Gear Co.
Greenshpon Engineering
Works Ltd.
Grove Gear
Grupos Diferenciales
Hamilton Gear
Harder Precision
Components
Harmonic Drive
Technologies
Harnischfeger
Hico
Horsburgh & Scott
Hub City, Inc.
ITW Spiroid
Indiana Power

Transmission Systems
Indiana Tool/Indiana Gear
Insc Corporation
Labeco
Lufkin Industries Gear
Repair
MO Star Gear & Machine
Maquinaria Ral, S.A.
Merit Gear Corp.
Micron Instrument Corp.
Milwaukee Gear Company
Mitrapak Power
Transmission Products
Moore Gear Mfg. Co.
Moore Machine & Gear
Nanchang Gear Works
Nissei Corp. of America
Nord Gear Corporation
Nuttall Gear Corp.
Ohio Gear
Ontario Drive & Gear
Overton Gear & Tool
PIC Design
Penn Machine Company
Pennsylvania Gear Corp.
Philadelphia Gear
Corp.-King of Prussia
Philadelphia Gear
Corp.-Houston
Power Eng. & Mfg. Ltd.
Precipart Corp.
Precision Gear Inc.
Precision Gears Inc.
The Purdy Corporation
R. Cushman & Associates
Rapid Gear
Reliance Gear Co. Ltd.
Reliance Gear Corp.

Renold Power
Transmission Corp.
Rexnord Corporation
Rj Link International
Rockwell Automation /
Dodge
Ronson Gears Pty. Ltd.
Santasalo Gears Service
Shin Shin Enterprises
Sri Venkateshwara Gear
Sterling Electric
Sumitomo Machinery
Sussex Gear Company
Torque Transmission
Trogetec Inc.
United States Gear
Von Ruden Mfg.
Walter Machine Co., Inc.
Wedin Intl. Inc.
Wes-Tex Gear Inc.
Westech Gear
Westerman Companies
Weyers Bros (FT) Ltd.
Winsmith
ZF Industrial Drives
Zenith Sintered Products
Zero-Max, Inc.

Gear Couplings

Amarillo Gear
Co.-Russellville
Harmonic Drive
Technologies
Lovejoy Inc.
TB Wood's, Inc.

Gear Motors

Bison Gear & Engineering
Bonfiglioli Riduttori
C-B Gear & Machine, Inc.
Channel Power
Transmission, Inc.
Euclid Universal Corp.
Fleet Tools Ltd.
Greenshpon Engineering
Works Ltd.
Groschopp
Grove Gear
Hub City, Inc.
Nissei Corp. of America
Nord Gear Corporation
Ohio Gear
Renold Power
Transmission Corp.
Rexnord Corporation
Ronson Gears Pty. Ltd.
Sri Venkateshwara Gear

Gear Reducers

American Metric Corp.
Andantex USA
Channel Power
Transmission Inc.

Gears-Helical

ACR Industries
Acme Gear Co.

The Adams Company
Adobe Precision Gear, Inc.
Advance Gear & Machine
Aero Gear, Inc.
Aerocom Industries Inc.
Allied Devices Corp.
Allied Gear Co.
Amarillo Gear Co.-Amarillo
Amarillo Gear
Co.-Russellville
American Gear & Eng.
American Mach. & Gear
American Precision Gear
Andantex USA
Aplus Engineering Inc.
Arrow Gear Co.
Ashot Ashkelon Indust.
Ashot USA Inc.
Axicon Technologies
Barit International Corp.
Bengal Industries Inc.
Bevel Gears (India)
Bilgram Gear Co.
Bonfiglioli Riduttori
Bonfiglioli U.K.
Boonville Mining Services
Boston Gear
Bourn & Koch
Boxx Gear Mfg.
Buckeye Gear Co.
Bucyrus International, Inc.
Burgess-Norton Mfg. Co.
C-B Gear & Machine, Inc.
CMD (UK) Ltd.
Calicut Eng. Works Ltd.
Capstan Atlantic
Carbon City Products
Caterpillar Industrial
Products Inc.
Channel Power
Transmission, Inc.
Chardam Gear Co.
Charles Bond Co.
Chicago Gear-D. O. James
Chicago Gear Works
Ciateq, A. C.
The Cincinnati Gear Co.
Circle Gear & Machine
Cloyes Gear & Products
Columbia Gear Co.
Commercial Gear &
Sprocket
Crown Gear B.V.
Curtis Machine Co. Inc.
Dabko Industries Inc.
Davall Gear Co. Ltd.
Dayton Gear & Tool
Dearborn Gear & Tool Co.
E.C. Machining, Inc.
EMCO Gears
Electra-Gear
Electretex Ltd. (India)
Engelhardt Gear Co.
Engranes Industriales
Rivera
Engrecon S.A.

Euclid Universal Corp.
Fairfield Mfg. Co.
Falk Corp.
Federal Gear Corp.
Fleet Tools Ltd.
Flender Corporation
Foote-Jones/Illinois Gear
Forest City Gear Co.
Franke Gear Works Inc.
GW Plastics
Gear Company of America
Gear Products Inc.
Gear Systems Inc.
The Gear Works-Seattle
Gears & Drive Systems
Geartronics Industries
General Gear Corporation
Generated Gear &
Machine
Global Gear
Globe Gear Co.
Great Gear Co.
Greenshpon Engineering
Works Ltd.
HMC
Hamilton Gear
Hanover Gear Mfg. Co.
Harder Precision
Components
Harnischfeger
Hico
Holroyd Machine
Horsburgh & Scott
Hua Yang Machine
Hub City, Inc.
Insc Corporation
Intech Corp.
Invo Spine Inc.
J&E Hofmann Eng.
Jackson Gear Co.
Jade Precision Gear Co.
KA-Wood Gear
Keller Machine Co.
Kreiter Gearteck
Krupp Engineering Inc.
L + H Welding & Machine
Lawler Gear Corp.
Lufkin Industries Gear
Repair
Lyon Gear
M.J.H. Gear & Tool Co.
MO Star Gear & Machine
Maquinaria Ral, S.A.
Mascotech-Braun
Merit Gear Corp.
Micron Instrument Corp.
Midwest Gear
Midwest Gear & Tool
Milford Gear Works
Milwaukee Gear Company
Molon Gear & Shaft
Moore Gear Mfg. Co.
Moore Machine & Gear
Murray Brothers Mfg.
Nanchang Gear Works
National Broach
Niagara Gear Corp.

Nissei Corp. of America
Nixon Gear
Nord Gear Corporation
Nordberg Lokomo OY
Nuttall Gear Corp.
Oliver Gear
Omni Gear & Machine
O'Neill Gear
Ontario Drive & Gear
Overton Gear & Tool
PIC Design
Patterson Gear & Machine
Penn Machine Company
Pennsylvania Gear Corp.
Penntech
Perry Technology
Philadelphia Gear
Corp.-King of Prussia
Philadelphia Gear
Corp.-Houston
Poly Hi Solidur
Power Eng. & Mfg. Ltd.
Precipart Corp.
Precision Gear Co.
Precision Gear Inc.
Precision Gears Inc.
Presrite Corp.
Process Industries
Production Gear & Broach
Progressive Engineering
The Purdy Corporation
Qualicast Corp.
R.L. Wagner & Assoc.
Rapid Gear
Rawling Gear
Reliance Gear Co. Ltd.
Reliance Gear Corp.
Riley Gear Corp.
Riverside Spine & Gear
Rj Link International
Ronson Gears Pty. Ltd.
STD Precision Gear &
Instrument, Inc.
Santasalo Gears Service
Satellite Gear
Schafer Gear Works Inc.
Sri Venkateshwara Gear
Sterling Electric
Stock Drive Prod./Sterling
Instrument
Tech Sales Inc.
Textile Parts & Machine
Tifco Gage & Gear
Trojan Gear Inc.
United States Gear
Von Ruden Mfg.
Walter Machine Co., Inc.
Wedin Intl. Inc.
Wes-Tex Gear Inc.
West Industries Inc.
Westech Gear
Western Spine Gage
Worcester Gear Works
Worrall Grinding Co.
Xtek Inc.
Zenith Sintered Products

Gears-Herringbone

Adobe Precision Gear, Inc.
American Mach. & Gear
Anderson International
Aplus Engineering Inc.
Axicon Technologies
Bilgram Gear Co.
Boonville Mining Services
C-B Gear & Machine, Inc.
CMD (UK) Ltd.
Calicut Eng. Works Ltd.
Chicago Gear-D. O. James
Ciateq, A. C.
The Cincinnati Gear Co.
Circle Gear & Machine
Dayton Gear & Tool
Engelhardt Gear Co.
Engranes Industriales
Rivera
Falk Corp.
Federal Gear Corp.
Foote-Jones/Illinois Gear
The Gear Works-Seattle
Gears & Drive Systems
Globe Gear Co.
Great Gear Co.
HMC
Hamer Gear
Horsburgh & Scott
Intech Corp.
J&E Hofmann Eng.
Kreiter Gearteck
L + H Welding & Machine
Lufkin Industries Gear
Repair
Maquinaria Ral, S.A.
Midwest Gear
Moore Gear Mfg. Co.
Nordberg Lokomo OY
Oliver Gear
Penn Machine Company
Philadelphia Gear
Corp.-Houston
Precision Gear Inc.
Process Industries
Progressive Engineering
Qualicast Corp.
Rapid Gear
Santasalo Gears Service
Shin Shin Enterprises
Wes-Tex Gear Inc.
Westech Gear
Westerman Companies
Xtek Inc.

Gears-Hypoid

ACR Industries
ATA Gears Inc.
Aero Gear, Inc.
Amarillo Gear
Co.-Amarillo
Amarillo Gear
Co.-Russellville
Arrow Gear Co.
Ashot Ashkelon Indust.
Ashot USA Inc.
Astron Midwestern Inc.
Bevel Gears (India)
Bonfiglioli Riduttori
Bonfiglioli U.K.
Caterpillar Industrial
Products Inc.
Channel Power
Transmission, Inc.
Davall Gear Co. Ltd.
Engelhardt Gear Co.
Engrecon S.A.
Fairfield Mfg. Co.

Foote-Jones/Illinois Gear
Globe Gear Co.
Great Gear Corp.
Grupos Diferenciales
Hamilton Gear
Midwest Gear & Tool
Moore Gear Mfg. Co.
Nissei Corp. of America
Ohio Gear
Philadelphia Gear
Corp.-King of Prussia
Precision Gear Co.
Presrite Corp.
Qualicast Corp.
Rawling Gear
Reliance Gear Corp.
Santasalo Gears Service
United States Gear
Wedin Intl. Inc.
West Industries Inc.
Westech Gear

Gears-Internal

ACR Industries
Acme Gear Co.
The Adams Company
Adobe Precision Gear, Inc.
Advance Gear & Machine
Aero Gear, Inc.
Aerocom Industries Inc.
Allied Devices Corp.
Allied Gear Co.
Amarillo Gear
Co.-Russellville
American Gear & Eng.
American Mach. & Gear
American Precision Gear
Aplus Engineering Inc.
Arrow Gear Co.
Axicon Technologies
Bengal Industries Inc.
Bevel Gears (India)
Bilgram Gear Co.
Blanchat Machine Co.
Boston Gear
Boxx Gear Mfg.
Buckeye Gear Co.
CMD (UK) Ltd.
Calicut Eng. Works Ltd.
Carbon City Products
Caterpillar Industrial
Products Inc.
Chardam Gear Co.
Charles Bond Co.
Chicago Gear-D. O. James
Chicago Gear Works
The Cincinnati Gear Co.
Circle Gear & Machine
Cloyes Gear & Products
Columbia Gear Co.
Commercial Gear &
Sprocket
Davall Gear Co. Ltd.
Dayton Gear & Tool
Dynamic Tool Grinding
EMCO Gears
Engelhardt Gear Co.
Engranes Industriales
Rivera
Engrecon S.A.
Fairfield Mfg. Co.
Federal Gear Corp.
Fleet Tools Ltd.
Foote-Jones/Illinois Gear
Forest City Gear Co.
Frank Gear Works Inc.
Gear Company of America
Gear Products Inc.

The Gear Works-Seattle
Geartronics Industries
Generated Gear &
Machine
Globe Gear Co.
Greenshpon Engineering
Works Ltd.
HMC
Hamilton Gear
Hanover Gear Mfg. Co.
Harder Precision
Components
Harnischfeger
Highway Machine Co.
Horsburgh & Scott
Hua Yang Machine
ITW Spiroid
Indiana Tool/Indiana Gear
Intech Corp.
Invo Spline Inc.
J&E Hofmann Eng.
Jackson Gear Co.
Jade Precision Gear Co.
KA-Wood Gear &
Machine
Kreiter Gearteck
Krupp Engineering Inc.
L + H Welding & Machine
Lawler Gear Corp.
Lyon Gear
M.J.H. Gear & Tool Co.
MO Star Gear & Machine
Maquinaria Ral, S.A.
Mascoetech-Braun
Micron Instrument Corp.
Midwest Gear
Midwest Gear & Tool
Milford Gear Works
Milwaukee Gear Company
Modified Gear & Spline
Moore Gear Mfg. Co.
Moore Machine & Gear
Nanchang Gear Works
Nissei Corp. of America
Nixon Gear
Nordberg Lokomo OY
Oliver Gear
Omni Gear & Machine
O'Neill Gear
Ontario Drive & Gear
Orlandi Gear Company
Overton Gear & Tool
Patterson Gear & Machine
Penn Machine Company
Pennsylvania Gear Corp.
Penntech
Perry Technology
Philadelphia Gear
Corp.-Houston
Philadelphia Gear
Corp.-King of Prussia
Power Eng. & Mfg.
Precipart Corp.
Precision Gear Co.
Precision Gear Inc.
Precision Gears Inc.
Process Industries
Production Gear & Broach
Progressive Engineering
The Purdy Corporation
Rapid Gear
Rawling Gear
Reliance Gear Co. Ltd.
Reliance Gear Corp.
Riley Gear Corp.
Riverside Spline & Gear
Rj Link International
Ronson Gears Pty. Ltd.

STD Precision Gear
Santasalo Gears Service
Satellite Gear
Schafer Gear Works Inc.
Shin Shin Enterprises
Sri Venkateshwara Gear
Textile Parts & Machine
Tifco Gage & Gear
Trogetec Inc.
Trojon Gear Inc.
United States Gear
Von Ruden Mfg.
Wedin Intl. Inc.
West Industries Inc.
Westech Gear
Winzeler Gear
Worcester Gear Works
Xtek Inc.

Gears-Master

ACR Industries
Amarillo Gear
Co.-Russellville
American Mach. & Gear
Arrow Gear Co.
Barit International Corp.
Boston Gear
CMD (UK) Ltd.
The Cincinnati Gear Co.
Davall Gear Co. Ltd.
Dayton Gear & Tool
Delroyd Worm Gear
Engelhardt Gear Co.
Engranes Industriales
Rivera
Fairfield Mfg. Co.

Fellows Corp.

Fleet Tools Ltd.
Forest City Gear Co.
The Gear Works-Seattle
Generated Gear &
Machine

Holroyd Machine

ITW Heartland
ITW Spiroid
Invo Spline Inc.

M&M Precision Systems

Mahr Corporation
Modified Gear & Spline
Nanchang Gear Works

National Broach

Nixon Gear
Perry Technology

Philadelphia Gear
Corp.-Houston
Philadelphia Gear
Corp.-King of Prussia

Precision Gage Co.
Precision Gear Inc.

The Purdy Corporation

Russell, Holbrook & Henderson

SRP Tools Ltd.
SU America Inc.
Santasalo Gears Service

Shin Shin Enterprises
Spline Gauges Ltd.

Tifco Gage & Gear
Trogetec Inc.

Westerman Companies
Western Spline Gage

Gears-Miter

Adobe Precision Gear, Inc.
American Gear & Eng.
American Precision Gear
Hub City, Inc.
Santasalo Gears Service

Gears-Non-Circular

Advance Gear & Machine
Bengal Industries Inc.
Bilgram Gear Co.
Calicut Eng. Works Ltd.
Cunningham Industries
GW Plastics
Gear Company of America
Generated Gear &
Machine
Globe Gear Co.
Horsburgh & Scott
J&E Hofmann Eng.
Krupp Engineering Inc.
Merit Gear Corp.
Midwest Gear & Tool
Perry Technology
Precision Gear Inc.
Trogetec Inc.
Wedin Intl. Inc.
Worcester Gear Works

Gears-Planetary

Acme Gear Co.
Adobe Precision Gear, Inc.
Amarillo Gear
Co.-Russellville
American Gear & Eng.
American Precision Gear
CMD (UK) Ltd.
Capitol Stampings Corp.
Greenshpon Engineering
Works Ltd.
Rapid Gear
STD Precision Gear
Santasalo Gears Service

Gears-Plastic

Acme Gear Co.
Allied Devices Corp.
American Gear & Eng.
American Mach. & Gear
American Precision Gear
Andantex USA
Arrow Gear Co.
Bengal Industries Inc.
Bilgram Gear Co.
Boston Gear
Buckeye Gear Co.
Calicut Eng. Works Ltd.
Capitol Stampings Corp.
Chicago Gear-D. O. James
Chicago Gear Works
Commercial Gear &
Sprocket
Dabko Industries Inc.
EMCO Gears
Engranes Industriales
Rivera
Forest City Gear Co.
GW Plastics
Gear Company of America
Gear Systems Inc.
The Gear Works-Seattle
Gears & Drive Systems
Geartronics Industries
Generated Gear &
Machine
Globe Gear Co.

Great Gear Corp.

Intech Corp.
J&E Hofmann Eng.
KA-Wood Gear &
Machine
Keller Machine Co.
M.J.H. Gear & Tool Co.
Martin Sprocket & Gear
Midwest Gear

Midwest Gear & Tool

Moore Gear Mfg. Co.
Moore Machine & Gear
Murray Brothers Mfg.
Omni Gear & Machine
PIC Design
Perry Technology
Philadelphia Gear
Corp.-Houston
Precision Gear Co.
Precision Gears Inc.
Process Industries
Progressive Engineering
Putnam Precision
Molding, Inc.
R.L. Wagner & Assoc.
Rapid Gear
Reliance Gear Corp.
Riley Gear Corp.
Shin Shin Enterprises
Textile Parts & Machine
Tifco Gage & Gear
Trogetec Inc.
Trojon Gear Inc.
Wedin Intl. Inc.
Winzeler Gear
Worcester Gear Works

Gears-Powder Metal

Aplus Engineering Inc.
Asco Sintering Co.
Ashot USA Inc.
BestMetal Corp.
Burgess-Norton Mfg. Co.
Capstan Atlantic
Carbon City Products
Cloyes Gear & Products
Dabko Industries Inc.
The Gear Works-Seattle
Great Gear Corp.
ITW Spiroid
Keystone Powdered Metal
Lyon Gear

M&M Precision Systems

Martin Sprocket & Gear
Metal Powder
Components
Moore Gear Mfg. Co.
Pennsylvania Pressed
Metal Inc.
Precision Gear Co.
St. Marys Carbon Co.

Shin Shin Enterprises

Tifco Gage & Gear
Trogetec Inc.
Zenith Sintered Products

Gears-Racks

ACR Industries
Allied Devices Corp.
American Mach. & Gear
American Metric Corp.
American Precision Gear
Andantex USA
Anderson International
Aplus Engineering Inc.
Asco Sintering Co.
Bevel Gears (India)
Boonville Mining Services
Boston Gear
C-B Gear & Machine, Inc.
Capstan Atlantic
Carbon City Products
Charles Bond Co.
The Cincinnati Gear Co.
Circle Gear & Machine
Commercial Gear &
Sprocket

Cornell Forge Co.
 Dabko Industries Inc.
 Davall Gear Co. Ltd.
 Dayton Gear & Tool
 EMCO Gears
 Engelhardt Gear Co.
 Engranes Industriales
 Rivera
 Federal Gear Corp.
Fellows Corp.
 Fleet Tools Ltd.
 Foote-Jones/Illinois Gear
 Franke Gear Works Inc.
 GW Plastics
 Gear Company of America
 The Gear Works-Seattle
 Gears & Drive Systems
 Geartronic Industries
 Generated Gear &
 Machine
 Globe Gear Co.
 HMC
 Harder Precision
 Components
 Harnischfeger
 Highway Machine Co.
 Hua Yang Machine
 Intech Corp.
 J&E Hofmann Eng.
 Jade Precision Gear Co.
 Keystone Powdered Metal
 Krupp Engineering Inc.
 Lawler Gear Corp.
 MO Star Gear & Machine
 Maquinaria Ral, S.A.
 Martin Sprocket & Gear
 Modified Gear & Spline
 Moore Gear Mfg. Co.
 Moore Machine & Gear
National Broach
 Nixon Gear
 Oliver Gear
 Patterson Gear & Machine
Perry Technology
 Pitch Templates, Inc.
 Ply-Mar Tool Co
 Poly Hi Solidur
 Precipart Corp.
 Progressive Engineering
 Pulley Manufacturers Inc.
 Qualicast Corp.
 Rapid Gear
 Reliance Gear Co. Ltd.
 Riley Gear Corp.
 Riverside Spline & Gear
 Ronson Gears Pty. Ltd.
 STD Precision Gear
 Satellite Gear
Shin Shin Enterprises
 Sri Venkateshwara Gear
 Trogetec Inc.
 Trojon Gear Inc.
 Wedin Intl. Inc.
 Worcester Gear Works
 Xtek Inc.

Gears-Ring

Acme Gear Co.
 Amarillo Gear
 Co.-Russellville
 American Gear & Eng.
 American Precision Gear
 Boonville Mining Services
 C-B Gear & Machine, Inc.
 Circle Gear & Machine
 Davall Gear Co. Ltd.
 Delroyd Worm Gear
 Engelhardt Gear Co.

Hamilton Gear
 Indiana Tool/Indiana Gear
 Inco Corporation
 Jade Precision Gear Co.
 MO Star Gear & Machine
 Nissei Corp. of America
 Overton Gear & Tool
 Production Gear & Broach
 Rapid Gear
 Rawling Gear
 Reliance Gear Co. Ltd.
 Ronson Gears Pty. Ltd.
 STD Precision Gear
 Santasalo Gears Service
 Sri Venkateshwara Gear

Gears-Segment

Acme Gear Co.
 Amarillo Gear
 Co.-Russellville
 American Precision Gear
 C-B Gear & Machine, Inc.
 Circle Gear & Machine
 Davall Gear Co. Ltd.
 Delroyd Worm Gear
 Engelhardt Gear Co.
 Euclid Universal Corp.
 Hamilton Gear
 ITW Spiroid
 Nissei Corp. of America
 Production Gear & Broach
 Rapid Gear
 Rawling Gear
 Ronson Gears Pty. Ltd.
 STD Precision Gear
 Sri Venkateshwara Gear

Gears-Spiral Bevel

ACR Industries
ATA Gears Inc.
 Advance Gear & Machine
 Aero Gear, Inc.
Amarillo Gear
 Co.-Amarillo
 Amarillo Gear
 Co.-Russellville
 Arrow Gear Co.
 Asco Sintering Co.
 Ashot Ashkelon Indust.
 Astron Midwestern Inc.
 Blanchat Machine Co.
 Bonfiglioli Riduttori
 Bonfiglioli U.K.
 Boston Gear
 Bourm & Koch
 Burgess-Norton Mfg. Co.
 CMD (UK) Ltd.
 Carbon City Products
 Caterpillar Industrial
 Products Inc.
 Channel Power
 Transmission, Inc.
 Chicago Gear-D. O. James
 Ciateq, A. C.
 The Cincinnati Gear Co.
 Curtis Machine Co. Inc.
 Davall Gear Co. Ltd.
 Electrex Ltd. (India)
 Engelhardt Gear Co.
 Engranes Industriales
 Rivera
 Engrecon S.A.
 Fairfield Mfg. Co.
 Falk Corp.
 Foote-Jones/Illinois Gear
 The Gear Works-Seattle
 Gears & Drive Systems
 Globe Gear Co.

Precision Workholding Equals Precision Gearing *and nobody equals* **EMUGE**

A mechanical **EMUGE** workholding solution will immediately boost your part quality and productivity. Clamp on a symmetrical or irregular surface—pitch diameter clamping is our absolute specialty.

But let's get precise

- Accurate to within 20 millionth of an inch
- Perfect concentricity
- Perfect repeatability
- Part-family interchangeability
- Easy to install and maintain
- Mechanical reliability

Let's discuss an **EMUGE** precision workholding solution for you today!

EMUGE

104 Otis Street • Northborough • MA 01532 • 800 323 3013 • 508 393 1310 Fax

CIRCLE 130

Great Gear Corp.
 Grupos Diferenciales
 Hamilton Gear
 Hico
 Horsburgh & Scott
 Hua Yang Machine
 Hub City, Inc.
 Intech Corp.
 Keystone Powdered Metal
 Krupp Engineering Inc.
 Micron Instrument Corp.
Midwest Gear & Tool
 Milford Gear Works
 Moore Gear Mfg. Co.
 Nanchang Gear Works
 Nissei Corp. of America
 Ohio Gear
 PIC Design
 Philadelphia Gear
 Corp.—Houston
 Philadelphia Gear
 Corp.—King of Prussia
 Precision Gear Co.
Presrite Corp.
The Purdy Corporation
 Rawling Gear
 Reliance Gear Corp.
 Riverside Spline & Gear
 Santasalo Gears Service
Shin Shin Enterprises
 Tech Sales Inc.
 United States Gear
 Von Ruden Mfg.
 Wedin Intl. Inc.
 West Industries Inc.
 Westech Gear
 Winzeler Gear

Gears-Spur

ACR Industries
 Acme Gear Co.
 The Adams Company
 Adobe Precision Gear, Inc.
 Advance Gear & Machine
 Aero Gear, Inc.
 Aerocom Industries Inc.
 Albro Gear & Instrument
 Allied Devices Corp.
Allied Gear Co.
 Amarillo Gear
 Co.—Russellville
 American Gear & Eng.
 American Mach. & Gear
 American Metric Corp.
 American Precision Gear
 Aplus Engineering Inc.
 Arrow Gear Co.
 Asco Sintering Co.
 Ashot Ashkelon Indust.
 Ashot USA Inc.
 Axicon Technologies
Barit International Corp.
 Bengal Industries Inc.
 Bevel Gears (India)
 Bilgram Gear Co.
 Blanchat Machine Co.
 Bonfiglioli U.K.
 Boonville Mining Services
 Boston Gear
 Bourn & Koch
 Boxx Gear Mfg.
 Buckeye Gear Co.
 Bucyrus International, Inc.
 Burgess-Norton Mfg. Co.
 C-B Gear & Machine, Inc.
 CMD (UK) Ltd.
 Calicut Eng. Works Ltd.
 Capstan Atlantic

Carbon City Products
 Caterpillar Industrial
 Products Inc.
 Channel Power
 Transmission, Inc.
 Chardam Gear Co.
 Charles Bond Co.
 Chicago Gear-D. O. James
 Chicago Gear Works
 Ciateq, A. C.
 The Cincinnati Gear Co.
 Circle Gear & Machine
 Cloyes Gear & Products
 Columbia Gear Co.
 Commercial Gear &
 Sprocket
 Cornell Forge Co.
Crown Gear B.V.
 Cunningham Industries
 Curtis Machine Co. Inc.
 Cyclo Transmissions Ltd.
 Dabko Industries Inc.
 Davall Gear Co. Ltd.
 Dayton Gear & Tool
 Dearborn Gear & Tool Co.
 Dynamic Tool Grinding
 E.C. Machining, Inc.
 EMCO Gears
 Electrex Ltd. (India)
 Engelhardt Gear Co.
 Engranos Industriales
 Rivera
 Engrecon S.A.
 Euclid Universal Corp.
 Fairfield Mfg. Co.
 Falk Corp.
 Federal Gear Corp.
 Fleet Tools Ltd.
 Foote-Jones/Illinois Gear
 Forest City Gear Co.
 Franke Gear Works Inc.
 GW Plastics
 Gear Company of America
 Gear Products Inc.
 Gear Systems Inc.
 The Gear Works-Seattle
 Gears & Drive Systems
 Geartronics Industries
 General Gear Corporation
 Generated Gear &
 Machine
Global Gear
 Globe Gear Co.
 Great Lakes Industry, Inc.
 Greenshon Engineering
 Works Ltd.
 HMC
 Hamilton Gear
 Hand Screw Machine
 Hanover Gear Mfg. Co.
 Harder Precision
 Components
 Harnischfeger
 Horsburgh & Scott
 Howard's Machine Shop
 Hua Yang Machine
 Hub City, Inc.
 ITW Spiroid
 Indiana Tool/Indiana Gear
 Inseo Corporation
 Intech Corp.
 Invo Spline Inc.
 J&E Hofmann Eng.
 Jackson Gear Co.
 Jade Precision Gear Co.
 KA-Wood Gear &
 Machine
 Keller Machine Co.

Keystone Powdered Metal
 Kreiter Geartech
 Krupp Engineering Inc.
 L + H Welding & Machine
 Lampin Corporation
 Lawler Gear Corp.
 Lufkin Industries Gear
 Repair
 Lyon Gear
 M.J.H. Gear & Tool Co.
 MO Star Gear & Machine
 Maquinaria Ral, S.A.
 Martin Sprocket & Gear
 Merit Gear Corp.
 Micron Instrument Corp.
Midwest Gear
Midwest Gear & Tool
 Milford Gear Works
 Milwaukee Gear Company
 Mobile Pulley & Machine
 Modified Gear & Spline
 Molon Gear & Shaft
 Moore Gear Mfg. Co.
 Moore Machine & Gear
 Murray Brothers Mfg.
 Nanchang Gear Works
Niagara Gear Corp.
 Nissei Corp. of America
 Nixon Gear
 Nordberg Lokomo OY
 Oliver Gear
 Omni Gear & Machine
 O'Neill Gear
Ontario Drive & Gear
 Orlandi Gear Company
 Overton Gear & Tool
 PIC Design
 Patterson Gear & Machine
 Penn Machine Company
 Pennsylvania Gear Corp.
 Pennsylvania Pressed
 Metal Inc.
 Penntech
Perry Technology
 Philadelphia Gear
 Corp.—Houston
 Philadelphia Gear
 Corp.—King of Prussia
 Poly Hi Solidur
 Power Eng. & Mfg.
 Precipart Corp.
 Precision Gear Co.
 Precision Gear Inc.
 Precision Gears Inc.
Presrite Corp.
 Process Industries
 Production Gear & Broach
 Progressive Engineering
 Pulley Manufacturers Inc.
The Purdy Corporation
 Putnam Precision
 Molding, Inc.
 Qualicast Corp.
 R.L. Wagner & Assoc.
 Rapid Gear
 Rawling Gear
 Reliance Gear Co. Ltd.
 Reliance Gear Corp.
 Riley Gear Corp.
 Riverside Spline & Gear
 Rj Link International
 Ronson Gears Pty. Ltd.
 Ryle Manufacturing Co.
 STD Precision Gear
 Santasalo Gears Service
 Satellite Gear
 Schafner Gear Works Inc.
Shin Shin Enterprises

Sri Venkateshwara Gear
 St. Marys Carbon Co.
Stock Drive Prod/Sterling
Instrument
 Tech Sales Inc.
 Textile Parts & Machine
 Tifco Gage & Gear
 Trogetec Inc.
 Trojor Gear Inc.
 United States Gear
 Von Ruden Mfg.
 Walter Machine Co., Inc.
 Wedin Intl. Inc.
 West Industries Inc.
 Westech Gear
 Westernman Companies
Western Spline Gear
 Windsor Gear Co.
 Winzeler Gear
 Wohlert Corp.
 Worcester Gear Works
 Worrall Grinding Co.
 Xtek Inc.
 Zhuhai Intercontinental
 Pulleys Ltd.

Gears-Straight Bevel

ACR Industries
 The Adams Company
 Adobe Precision Gear, Inc.
 Advance Gear & Machine
 Aero Gear, Inc.
 Allied Devices Corp.
Allied Gear Co.
 Amarillo Gear
 Co.—Russellville
 American Gear & Eng.
 American Mach. & Gear
 American Metric Corp.
 American Precision Gear
 Arrow Gear Co.
 Asco Sintering Co.
 Ashot Ashkelon Indust.
 Ashot USA Inc.
 Astron Midwestern Inc.
 Bengal Industries Inc.
 Bevel Gears (India)
 Bilgram Gear Co.
 Bonfiglioli Riduttori
 Bonfiglioli U.K.
 Boston Gear
 Boxx Gear Mfg.
 Burgess-Norton Mfg. Co.
 C-B Gear & Machine, Inc.
 CMD (UK) Ltd.
 Calicut Eng. Works Ltd.
 Carbon City Products
 Caterpillar Industrial
 Products Inc.
 Channel Power
 Transmission, Inc.
 Chardam Gear Co.
 Charles Bond Co.
 Chicago Gear-D. O. James
 Chicago Gear Works
 Ciateq, A. C.
 Circle Gear & Machine
 Commercial Gear &
 Sprocket
 Cornell Forge Co.
 Curtis Machine Co. Inc.
 Dabko Industries Inc.
 Davall Gear Co. Ltd.
 Dayton Gear & Tool
 Engelhardt Gear Co.
 Engranos Industriales
 Rivera
 Engrecon S.A.

Fairfield Mfg. Co.
 Falk Corp.
 Federal Gear Corp.
 Fleet Tools Ltd.
 Foote-Jones/Illinois Gear
 GW Plastics
 Gear Company of America
 The Gear Works-Seattle
 Gears & Drive Systems
 Geartronics Industries
 Generated Gear &
 Machine
 Globe Gear Co.
Great Gear Corp.
 Grupos Diferenciales
 Hamilton Gear
 Hua Yang Machine
 Hub City, Inc.
 Intech Corp.
 J&E Hofmann Eng.
 Jackson Gear Co.
 Keystone Powdered Metal
 Krupp Engineering Inc.
 Lawler Gear Corp.
 M.J.H. Gear & Tool Co.
 MO Star Gear & Machine
 Maquinaria Ral, S.A.
 Martin Sprocket & Gear
 Mascotech-Braun
Midwest Gear & Tool
 Milford Gear Works
 Mitrpak Power
 Transmission Products
 Moore Gear Mfg. Co.
 Moore Machine & Gear
 Nanchang Gear Works
 Nissei Corp. of America
 Nixon Gear
 Nord Gear Corporation
 Ohio Gear
 Oliver Gear
 PIC Design
 Penn Machine Company
Perry Technology
 Philadelphia Gear
 Corp.—Houston
 Philadelphia Gear
 Corp.—King of Prussia
 Precipart Corp.
 Precision Gear Co.
Presrite Corp.
 Process Industries
 Progressive Engineering
The Purdy Corporation
 Rawling Gear
 Reliance Gear Co. Ltd.
 Reliance Gear Corp.
 Ronson Gears Pty. Ltd.
 Santasalo Gears Service
Shin Shin Enterprises
 Sri Venkateshwara Gear
Stock Drive Prod/Sterling
Instrument
 Textile Parts & Machine
 Torque Transmission
 Trogetec
 United States Gear
 Von Ruden Mfg.
 Wedin Intl. Inc.
 West Industries Inc.
 Westech Gear
 Windsor Gear Co.
 Winzeler Gear
 Wohlert Corp.
 Worcester Gear Works
 Xtek Inc.
 Zero-Max, Inc.

Gears-Worm

ACR Industries
 Acme Gear Co.
 The Adams Company
 Adobe Precision Gear, Inc.
 Advance Gear & Machine
 Aero Gear, Inc.
 Allied Devices Corp.
Allied Gear Co.
 Amarillo Gear
 Co.—Russellville
 American Gear & Eng.
 American Mach. & Gear
 American Precision Gear
 Aplus Engineering Inc.
 Bengal Industries Inc.
 Bevel Gears (India)
 Bilgram Gear Co.
 Blanchat Machine Co.
 Bonfiglioli Riduttori
 Bonfiglioli U.K.
 Boston Gear
 Bourn & Koch
 Boxx Gear Mfg.
 Buckeye Gear Co.
 C-B Gear & Machine, Inc.
 CMD (UK) Ltd.
 Calicut Eng. Works Ltd.
 Channel Power
 Transmission, Inc.
 Charles Bond Co.
 Chicago Gear-D. O. James
 Chicago Gear Works
 Ciateq, A. C.
 The Cincinnati Gear Co.
 Circle Gear & Machine
 Columbia Gear Co.
 Commercial Gear &
 Sprocket
 Cone Drive Operations
 Davall Gear Co. Ltd.
 Dayton Gear & Tool
 Delroyd Worm Gear
 EMCO Gears
 Electra-Gear
 Engelhardt Gear Co.
 Engranos Industriales
 Rivera
 Euclid Universal Corp.
 Falk Corp.
 Federal Gear Corp.
 Fleet Tools Ltd.
 Flender Corporation
 Foote-Jones/Illinois Gear
 Forest City Gear Co.
 Franke Gear Works Inc.
 GW Plastics
 Gear Company of America
 Gear Products Inc.
 Gear Systems Inc.
 The Gear Works-Seattle
 Gears & Drive Systems
 Geartronics Industries
 General Gear Corporation
 Generated Gear &
 Machine
 Globe Gear Co.
Great Gear Corp.
 Greenshon Engineering
 Works Ltd.
 Grove Gear
 Hamilton Gear
 Harder Precision
 Components
 Harnischfeger
Holroyd Machine
 Horsburgh & Scott
 Hua Yang Machine

Hub City, Inc.
 Indiana Tool/Indiana Gear
 Inco Corporation
 Intech Corp.
 J&E Hofmann Eng.
 Jackson Gear Co.
 KA-Wood Gear & Machine
 Keystone Threaded Products
 Lawler Gear Corp.
 M.J.H. Gear & Tool Co.
 MO Star Gear & Machine
 Maquinaria Ral, S.A.
 Martin Sprocket & Gear
 Milford Gear Works
 Moore Gear Mfg. Co.
 Moore Machine & Gear
 Nissei Corp. of America
 Nixon Gear
 Ohio Gear
 Oliver Gear
 Omni Gear & Machine
 O'Neill Gear
 PIC Design
 Patterson Gear & Machine
 Penn Machine Company
 Pennsylvania Gear Corp.
 Penntech
Perry Technology
 Philadelphia Gear Corp.—Houston
 Philadelphia Gear Corp.—King of Prussia
 Poly Hi Solidur
 Power Eng. & Mfg.
 Precipart Corp.
 Precision Gear Co.
 Precision Gear Inc.
 Precision Gears Inc.
 Process Industries
 Progressive Engineering
 Rapid Gear
 Rawling Gear
 Reliance Gear Co. Ltd.
 Reliance Gear Corp.
 Renold Power Transmission Corp.
 Rexnord Corporation
 Riley Gear Corp.
 Riverside Spline & Gear
 Ronson Gears Pty. Ltd.
 STD Precision Gear
 Santasalo Gears Service
 Satellite Gear
 Schafer Gear Works Inc.
Shin Shin Enterprises
 Sri Venkateshwara Gear
 Sterling Electric
Stock Drive Prod/Sterling Instrument
 Textile Parts & Machine
 Tifco Gage & Gear
 Trojon Gear Inc.
 Wedin Intl. Inc.
 West Industries Inc.
 Westech Gear
 Windsor Gear Co.
 Winzeler Gear
 Worcester Gear Works
Pinions
 Acme Gear Co.
 Adobe Precision Gear, Inc.
 Amarillo Gear Co.—Russellville
 American Gear & Eng.
 American Precision Gear

Andantex USA
 Anderson International
 Bevel Gears (India)
 Boonville Mining Services
 C-B Gear & Machine Inc.
 Capitol Stampings Corp.
 Circle Gear & Machine
 Delroyd Worm Gear
 E.C. Machining, Inc.
 General Gear Corporation
 Hanover Gear
 ITW Spiroid
 Indiana Tool/Indiana Gear
 Inco Corporation
 MO Star Gear & Machine
 Nissei Corp. of America
 Orlandi Gear Company
 Overton Gear & Tool
 Poly Hi Solidur
 Production Gear & Broach
 Pulley Manufacturers Inc.
 Rapid Gear
 Rawling Gear
 Reliance Gear Co. Ltd.
 Ronson Gears Pty. Ltd.
 STD Precision Gear
 Santasalo Gears Service
 Sri Venkateshwara Gear
Ratchets
 Amarillo Gear Co.—Russellville
 American Metric Corp.
 American Precision Gear
 Capitol Stampings Corp.
 Circle Gear & Machine
 Commercial Gear & Sprocket
 Davall Gear Co. Ltd.
 Engelhardt Gear Co.
 MO Star Gear & Machine
 Milford Gear Works
 Production Gear & Broach
 Rawling Gear
 Ronson Gears Pty. Ltd.
 STD Precision Gear
 Sri Venkateshwara Gear
Serrations
 Acme Gear Co.
 Adobe Precision Gear, Inc.
 Amarillo Gear Co.—Russellville
 American Gear & Eng.
 American Precision Gear
 Circle Gear & Machine
 Euclid Universal Corp.
 Fleet Tools Ltd.
 General Gear Corporation
 Milford Gear Works
 Orlandi Gear Company
 Production Gear & Broach
 Rapid Gear
 Rawling Gear
 Ronson Gears Pty. Ltd.
 STD Precision Gear
 Sri Venkateshwara Gear
Splines
 ACR Industries
 Acme Gear Co.
 The Adams Company
 Adobe Precision Gear, Inc.
 Advance Gear & Machine
 Aero Gear, Inc.
 Aerocom Industries Inc.
 Allied Devices Corp.
Allied Gear Co.

Amarillo Gear Co.—Russellville
 American Gear & Eng.
 American Mach. & Gear
 American Precision Gear
 Aplus Engineering Inc.
 Arrow Gear Co.
 Asco Sintering Co.
 Ashot Ashkelon Indust.
 Bevel Gears (India)
 Bilgram Gear Co.
 Blanchat Machine Co.
 Boonville Mining Services
 Boston Gear
 Boxx Gear Mfg.
 Buckeye Gear Co.
 Burgess-Norton Mfg. Co.
 C-B Gear & Machine, Inc.
 CMD (UK) Ltd.
 Calicut Eng. Works Ltd.
 Capstan Atlantic
 Carbon City Products
 Caterpillar Industrial Products Inc.
 Chardam Gear Co.
 Chicago Gear-D. O. James
 Ciateq, A. C.
 The Cincinnati Gear Co.
 Circle Gear & Machine
 Cloyes Gear & Products
 Cold Forming Technology
 Columbia Gear Co.
 Commercial Gear & Sprocket
 Curtis Machine Co. Inc.
 Dabko Industries Inc.
 Davall Gear Co. Ltd.
 Dayton Gear & Tool
 Dearborn Gear & Tool Co.
 Delroyd Worm Gear
 EMCO Gears
 Elmass North America
 Engelhardt Gear Co.
 Engranos Industriales
 Rivera
 Engrecon S.A.
 Euclid Universal Corp.
 Fairfield Mfg. Co.
 Federal Gear Corp.
 Fleet Tools Ltd.
 Foote-Jones/Ilinois Gear
 Forest City Gear Co.
 Franke Gear Works Inc.
 Gear Company of America
 Gear Products Inc.
 Gear Systems Inc.
 The Gear Works-Seattle
 Gears & Drive Systems
 Geartronics Industries
 General Gear Corporation
 Generated Gear & Machine
 Global Gear
Globe Gear Co.
 Great Gear Corp.
 HMC
 Hamilton Gear
 Hand Screw Machine
 Hanover Gear Mfg. Co.
 Harder Precision Components
 Harnischfeger
 Horsburgh & Scott
 Howard's Machine Shop
 Hua Yang Machine
 Hub City, Inc.
 Indiana Tool/Indiana Gear
 Inco Corporation

Getting your degree in gears is easy at Pfauter-Maag Cutting Tools

We offer two specialized classes. So, whether you are new to the gear business, need a refresher course or are interested in learning more about the latest metal removal and measuring techniques, we have a class for you.

✓ Basic Fundamentals

A comprehensive, four-day program consisting of a coordinated series of lectures given by Engineering, Production and Inspection staff members. It is an ideal course for individuals who are new to gear making and are seeking a basic understanding of gear geometry, nomenclature, manufacturing and inspection.

✓ Advanced Gear Process Dynamics

This course is a three-day, high-intensity clinic on modern metal removal and measuring techniques for spur and helical gears. It is structured for manufacturing and process management with an in-depth look at modern methods, applications and hardware in the gear manufacturing and measuring process.

Both courses include demonstrations of modern gear cutting at the American Pfauter/Pfauter-Maag facility in Loves Park, Illinois.

For more information call (815) 282-3000 or visit our web site at: <http://www.pmct.com>.

Pfauter-Maag Cutting Tools

CIRCLE 183

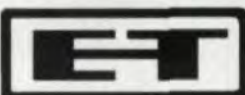

ENGINEERED HEAT TREAT, INC.
 31271 STEPHENSON HWY.
 MADISON HEIGHTS, MICH. 48071
 (248) 588-5141 • Fax (248) 588-6533

Certified Services

- CARBURIZE and HARDENING • Vertical to 11' • CARBONITRIDING
- DIE QUENCHING • VACUUM HEAT TREATING • NEUTRAL SALT BATH HARDENING
- NITRIDING • DEEP FREEZING TO -120°F • MARTEMPERING
- ATMOSPHERE PROCESS CONTROLLED BY COMPUTERIZED DATA LOGGER
- STRAIGHTENING • COMPLETE LABORATORY SERVICES

N.A.D.C.A.P. Approved • Aircraft Certified • Parts Metallurgically Engineered
ESTABLISHED IN 1959

CIRCLE 123

ATA GEARS, LTD., established in 1937, specializes in the manufacture of high quality power transmission components. Our main products are:

SPIRAL BEVEL GEARS – Klingelberg, maximum diameter 48 inches in ground, hard-cut or lapped finish.

OERLIKON - maximum crown wheel diameter 26 inches. Helical gears maximum diameter 49.2 inches, also with ground teeth and custom made right angle gears.

ATA offers free technical service for ATA gears. Our delivery time for spiral bevels is 1-3 months.

ATA GEARS, INC.
 19645 Detroit Road
 Rocky River, Ohio 44116
 Tele/Fax: 216-356-0289



ATA GEARS, LTD.
 P.O. Box 120, FIN-33101
 Tampere, Finland
 Tel: 356-3-2870111
 Fax: 356-3-2870249

CIRCLE 119

Complete Gear Manufacturing Process Control

From your single source for computerized analytical and functional gaging systems

- GearNet™ server automatically shares data for SPC, remote analysis and archiving.
- Simple, familiar interface ideal for manufacturing cell operators.
- Unmatched software selection, including bevel gear machine correction package.
- Pentium® based technology.
- Complete training and applications support with every system.

3500 Series CNC Gear Manufacturing Process Control Systems offer full four-axis flexibility and unsurpassed accuracy. Certification to .001mm traceable to NIST and probe resolution to .00002mm. You get greater productivity, too, with up to 20% faster throughput and capacities to 95" in diameter.

200 Series Systems provide all the performance and durability of the larger systems, but in a compact size that's perfect for high production parts up to 10" in diameter.



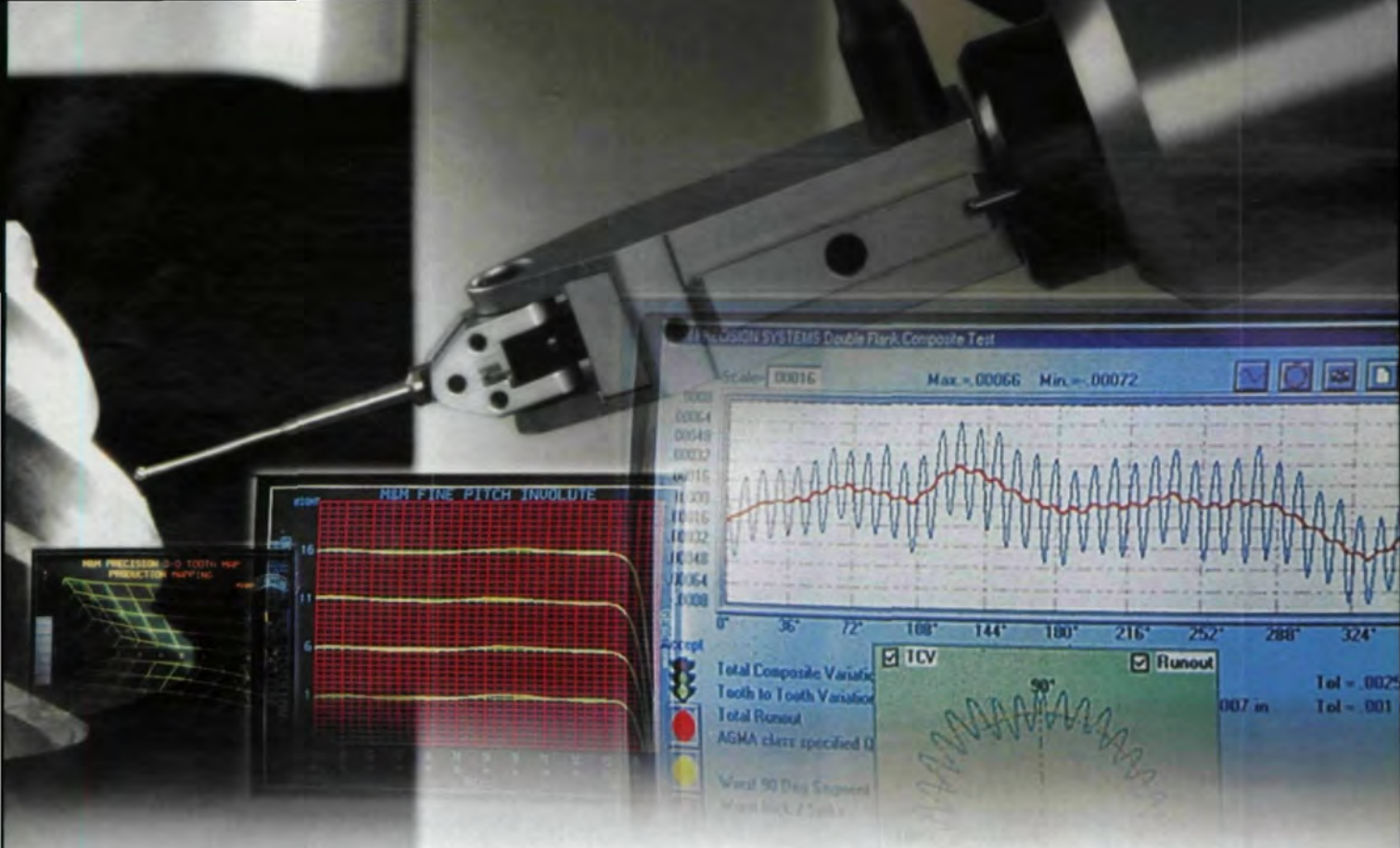

GRS-2 Double-Flank Gear Roller System combines proven performance with easy-to-use PC compatible software to make inspection accurate and simple. Total composite, tooth-to-tooth and runout tests determine if parts conform to specification. Computer analysis lets users specify AGMA or DIN standards, then determine the class of gear achieved.

Dimensions Over Pins Gage measures actual tooth thickness at the pitch diameter. A unique constant-pressure gaging head assures repeatability and accuracy over the full range of the gaging system—while greater throughput allows you to inspect more parts and reduce production costs.

Other M&M Precision Systems inspection products:

- Master Gears
- Spline Gages
- Variable Spline Indicators
- Fixture Gages
- Arbors

Free brochure Call 937/859-8273 or fax 937/859-4452.



M&M PRECISION SYSTEMS CORPORATION

"THE METROLOGY & MOTION PEOPLE"®

CIRCLE 140

A CUT ABOVE

- Solid Carbide Hobs for Dry Machining
- Heavy Duty Roughing and Finishing Hobs
- Indexable Carbide Insert Hobs
- Skive Hobs



883-E HAMPSHIRE ROAD
STOW, OH 44224-1120
PHONE: 330-940-4052
FAX: 330-940-3598

LEITZ METALWORKING TECHNOLOGY GROUP
BÖHLERIT • FETTE • KISLINGER

3725-1 N. 126TH ST.
BROOKFIELD, WI 53005
PHONE: 800-225-0852
FAX: 414-783-5043

CIRCLE 159

RADYNE

Innovators in Induction Heating
1-800-236-8360

CIRCLE 152

HANDS-ON TRAINING

Comprehensive courses for cylindrical and bevel/hypoid gear manufacturing, gear testing, special processes, and gear design. Get hands-on training at our in-house gear school, or we'll teach customized courses in your facility.

Call 800-643-2770 to request our catalog via voice mail, or call Mike Edmonds, Training Manager, at 716-256-8791 for more information.

Gleason

CIRCLE 129



BENEMAC Your Solution to Your Pitch Diameter Workholding Problems

Benemac offers a completely new concept to locate and grip on the Pitch Diameter of spur and helical gears up to 40° with the location of 15 or more pins. All using your existing workholding device.

Why not send us your drawings for review?

SYTEC Corporation
25 Middlesex Tpke. • P.O. Box 721 • Essex, CT 06426
Tel: 860-767-1322 • Fax: 860-767-1345 • www.sycor.com

CIRCLE 149

Intech Corp.
Invo Spline Inc.
J&E Hofmann Eng.
Jackson Gear Co.
Jade Precision Gear Co.
KA-Wood Gear & Machine
Keystone Powdered Metal
Kreiter Geartech
Krupp Engineering Inc.
L + H Welding & Machine
Lawler Gear Corp.
Lyon Gear
M&M Precision Systems
M.J.H. Gear & Tool Co.
MO Star Gear & Machine
Micromatic Textron

Midwest Gear
Midwest Gear & Tool
Milford Gear Works
Milwaukee Gear Company
Modified Gear & Spline
Moore Gear Mfg. Co.
Moore Machine & Gear
Murray Brothers Mfg.
Nanchang Gear Works
Niagara Gear Corp.
Nissei Corp. of America
Nixon Gear
Oliver Gear
Omni Gear & Machine
O'Neill Gear
Ontario Drive & Gear
Orlandi Gear Company
Overton Gear & Tool
Patterson Gear & Machine
Penn Machine Company
Pennsylvania Gear Corp.
Penntech

Perry Technology
Philadelphia Gear Corp.—Houston
Philadelphia Gear Corp.—King of Prussia
Power Eng. & Mfg.
Precipart Corp.
Precision Gear Co.
Precision Gear Inc.
Precision Gears Inc.
Process Industries
Production Gear & Brouch
Progressive Engineering
Pulley Manufacturers Inc.

The Purdy Corporation
R.L. Wagner & Assoc.
Rapid Gear
Rawling Gear
Reliance Gear Corp.
Riley Gear Corp.
Riverside Spline & Gear
Rj Link International
Ronson Gears Pty. Ltd.
STD Precision Gear
Santasalo Gears Service
Satellite Gear
Schafer Gear Works Inc.
Shin Shin Enterprises
Sri Venkateshwara Gear
St. Marys Carbon Co.
Tech Sales Inc.
Tifco Gage & Gear
Trogetec Inc.
Trojon Gear Inc.
United States Gear
Von Ruden Mfg.
Walter Machine Co., Inc.
Wedin Intl. Inc.
West Industries Inc.

Westech Gear
Western Spline Gage
Windsor Gear Co.
Worcester Gear Works
Xtek Inc.

Sprockets

Acme Gear Co.
Adobe Precision Gear, Inc.
Aero Gear, Inc.
Allied Devices Corp.
Allied Gear Co.
Amarillo Gear Co.—Russellville
American Gear & Eng.
American Mach. & Gear
American Metric Corp.
American Precision Gear
Blanchat Machine Co.
Boston Gear
Bourn & Koch
Buckeye Gear Co.
Burgess-Norton Mfg. Co.
C-B Gear & Machine, Inc.
Capitol Stampings Corp.
Capstan Atlantic
Carbon City Products
Channel Power

Transmission, Inc.
Chicago Gear-D. O. James
Circle Gear & Machine
Cloyes Gear & Products
Columbia Gear Co.
Davall Gear Co. Ltd.
Engelhardt Gear Co.
Fairfield Mfg. Co.
Fleet Tools Ltd.
Foote-Jones/Illinois Gear
Forest City Gear Co.
GW Plastics
Gear Products Inc.
Gears & Drive Systems

Global Gear
Globe Gear Co.
Great Lakes Industry, Inc.
Hamilton Gear
Inco Corporation
Intech Corp.

J&E Hofmann Eng.
Jackson Gear Co.
Jade Precision Gear Co.
Keystone Powdered Metal
Kreiter Geartech
L + H Welding & Machine
Lampin Corporation
Lyon Gear
MO Star Gear & Machine
Maquinaria Ral, S.A.
Martin Sprocket & Gear

Midwest Gear
Nixon Gear
Oliver Gear
PIC Design
Pennsylvania Gear Corp.
Penntech

Perry Technology
Poly Hi Solidur
Power Eng. & Mfg.
Presrite Corp.
Production Gear & Brouch
Pulley Manufacturers Inc.
Putnam Precision Molding, Inc.
Rapid Gear
Rawling Gear
Reliance Gear Corp.
Renold Power Transmission Corp.

Riverside Spline & Gear
Rj Link International
Ronson Gears Pty. Ltd.
Ryle Manufacturing Co.
STD Precision Gear
Santasalo Gears Service
Satellite Gear
Schafer Gear Works Inc.
Sri Venkateshwara Gear
Textile Parts & Machine
Torque Transmission
Trogetec Inc.
United States Gear
West Industries Inc.
Wohlert Corp.
Xtek Inc.
Zenith Sintered Products
Zhuhai Intercontinental Pulleys Ltd.

Timing Pulleys

Acme Gear Co.
Adobe Precision Gear, Inc.
Amarillo Gear Co.—Russellville
American Gear & Eng.
American Metric Corp.
American Precision Gear
Circle Gear & Machine
Davall Gear Co. Ltd.
E. C. Machining, Inc.
Engelhardt Gear Co.
Euclid Universal Corp.
Fleet Tools Ltd.
Jade Precision Gear Co.
Lampin Corporation
MO Star Gear & Machine
Poly Hi Solidur
Pulley Manufacturers Inc.
Rapid Gear
Rawling Gear
Reliance Gear Co. Ltd.
Ronson Gears Pty. Ltd.
STD Precision Gear
Santasalo Gears Service

Other Gears & Drives

Andantex USA—
Cycloidal Drives
Bevel Gears (India)—*Face Clutches, Custom-Made Gear Boxes*
Bonfiglioli Riduttori—*Planetary Gear Boxes*
C-B Gear & Machine, Inc.—*Gear Reducer Repair*
Capitol Stampings Corp.—*Steering Sectors*
Channel Power/Transmission, Inc.—*Cycloidal Drives*
Cold Forming Technology—*Prototype & Production Spline Rolling*
Commercial Gear & Sprocket—*Jaw Clutches, Large Diameter Gears*
Cone Drive Operations—*Double-Enveloping Worm Gears*
Crown Gear B.V.—Face Gears, Cylkro Gears
Davall Gear Co. Ltd.—*Face Clutches*
Delroyd Worm Gear—*Worm Gear Speed Reducers*
Euclid Universal Corp.—*Custom-Designed Gear Reducers*

DON'T MESH WITH ANYTHING LESS



PRESRITE NEAR-NET GEARS ARE NEAR PERFECT

If you want the best gears money can buy, invest some time with Presrite. We've already invested millions to build a world-class gear forging plant. A dedicated facility equipped with a state-of-the-art gear lab, high-capacity presses, and the latest in sophisticated machinery.

The results are gear-making capabilities that are second to none. We hot-forge gears economically to near-net shapes. Because we can meet such tight tolerances, there's little or no hobbing required. The inherent strength of the forging is maintained while costly roughing and finishing operations can be eliminated.

See why customers around the world—in all types of industries—have come to rely on Presrite for high-quality forged gears. Contact us today for more information or a quote.



Presrite Corporation

3665 East 78th Street, Cleveland, Ohio 44105
Phone: (216) 441-5990 • Fax: (216) 441-2644

We're as NEAR as the NET! Visit our Web site at www.presrite.com.

CIRCLE 108

Fairfield Mfg. Co.—
Custom Mechanical Assemblies. Design or build to print
 Federal Gear Corp.—
Gearbox x Rebuild & Recondition
 Fleet Tools Ltd.—*High-Precision Gearheads*
 Flender-Graffenstaden—
High Speed & Epicyclic
 Franke Gear Works Inc.—*Double Enveloping Worm & Gear Sets*
 Gajra Gears Ltd.—*Gear Transmissions*
 Gear Company of America—*Evoloids*
 Geartronics Industries—
Generated Pinion Rod
 General Gear Corporation—
High Helix Gears, Speedometer Gears & Rotors
 Globe Gear Co.—*Metric Gears*
 Hamer Gear—*Custom Gear Manufacturing*
 Hand Screw Machine—
Serrations for Strapping
 Harmonic Drive Technologies—
Harmonic Drive Transmissions
 ITW Spiroid—*Spiroid Gears, Helicon Gears*
 Keller Machine Co.—*Custom Gears & Sprockets*
 Micron Instrument Corp.—
Gearheads
 Nixon Gear—*Ground Gears*
 Ohio Gear—*Transmissions*
 Oliver Gear—*Gears Up To 10' Dia.*
 Orlandi Gear Company—
Hydraulic Pump Gears
 Philadelphia Gear Corp.—*King of Prussia—Epicyclic*
 Production Gear & Broach—*Internal Broaching*
**The Purdy Corporation—
 Curvic Couplings**
 R. Cushman & Associates—
Traction Drives
 Rawling Gear—*Face Clutches*
 Ronson Gears Pty. Ltd.—*Face Clutches*
 Spline Gauges Ltd.—
Oil Test Gears
 Sri Venkateshwara Gear—*Traction Drives*
 Sussex Gear Company—
Linear Actuators
 Trogetec Inc.—*Cycloidal Gears & Harmonic Gearing*
 United States Gear—*Curvic Couplings*
 Wedin Intl. Inc.—*Ground*

Gears to AGMA 14
 Westech Gear—*Specials*
 Wohler Corp.—*Flywheel Starter Ring Gears*
 Worral Grinding Co.—
Film Sprockets
 Zero-Max, Inc.—*Torque Limiters*

GEAR MANUFACTURING MACHINES

Broaching Machines

American Broach
 Colonial Tool Group Inc.
 Detroit Broach Co.
 Elmass North America
Fässler
 General Broach & Eng.
 Jack Dustman & Assoc.
 Kingsford Broach & Tool
 Miller Industrial Service
 Mitts & Merrill L.P.
National Broach
 The Ohio Broach & Machine Co.
 Sales Consultants
 Ty Miles Inc.

Chamfering Machines

American Wera Inc.
**Ataka Engineering—
 Basic Incorporated Group**
 Best Engineering Co., Inc.
 Bourm & Koch
Chamfermatic, Inc.
 Eltech Inc.
 GMI
 Jack Dustman & Assoc.
National Broach
 Ravjeet Eng. Specialties
 Redin Corporation
 SU America Inc.
 Schenck Turner
 V & R Associates
 WMW Machinery

Deburring Machines

Basic Incorporated Group
 Best Engineering Co., Inc.
 Burlytic Systems
 Eltech Inc.
 GMI
Holroyd Machine
 Jack Dustman & Assoc.
 Progressive Technologies
 Redin Corporation
 SU America Inc.
 Schenck Turner

EDM Machines

Basic Incorporated Group
 Bluegrass Precision Machinery
 Charmilles Technologies
 Easco-Sparcatron
 Hansvedt Industries Inc.
 KGK International Corp.
 Makino
 Mecatool USA Ltd.
 Okamoto Corp EDM Div.
 Raycon Corporation
 Sales Consultants

Generating Machines

American Pfauter, L.P.
**Ataka Engineering—
 Basic Incorporated Group**

The Gleason Works
 Sigma Pool-Liebherr
 V & R Associates
 WMW Machinery

Grinding Machines

American Broach
American Pfauter, L.P.
Basic Incorporated Group
 Bluegrass Precision Machinery
 Bourm & Koch
 Eltech Inc.
 GTI Technologies Inc.
The Gleason Works
Gleason-Pfauter Maschinenfabrik
 Hermes Machine Tool
 Höfler Maschinenbau
 Hoglund Technology
Holroyd Machine
 Lapmaster Intl.
 Meccanica Nova Corp
 Miller Industrial Service
Mitsubishi Machine Tool National Broach
Normac Inc.
 Okamoto Corp EDM Div.
 Reishauer Corp.
 SU America Inc.
 Sales Consultants
 Sigma Pool-Liebherr
 USACH Technologies
 WMW Machinery

Heat Treating Equipment

Ajax Magnethermic Corp.
 Bluegrass Precision Machinery
 Can-Eng Furnaces Ltd.
 Contour Hardening Inc.
Engineered Heat Treat
 The Grieve Corporation
 Holcroft
 Inductoheat Inc.
 K.H. Huppert Co.
 McEnglewan Industrial Furnace
 Pacific Industrial Furnace
 Pillar Industries
 Quench Press Specialists
Radyne Corporation
Surface Combustion Inc.
 TOCCO Inc.
 Therm Alliance Co.
 Welduction Corporation

Hobbing Machines

American Pfauter, L.P.
Basic Incorporated Group
 Bourm & Koch
 Fayscott Co.
The Gleason Works
Gleason-Pfauter Maschinenfabrik
 Hermes Machine Tool
Ikegai America Corp.
Koepfer America L.L.C.
Mitsubishi Machine Tool National Broach
Parker Industries
 Reishauer Corp.
 Sales Consultants
 Sigma Pool-Liebherr
 V & R Associates
 WMW Machinery

Honing Machines

American Pfauter, L.P.
Basic Incorporated Group
 Bates Technologies Inc.
 Bluegrass Precision Machinery
 Engis Corp.
Fässler
 GMI
The Gleason Works
National Broach
 Reishauer Corp.

Inspection Machines

Alpha Precision Inc.
American Pfauter, L.P.
Basic Incorporated Group
 Best Engineering Co., Inc.
 Bluegrass Machinery
 Bourm & Koch
D.I.G.I.T.
Dyer Company
 FGT Gage & Systems Inc.
Giddings & Lewis
The Gleason Works
ITW Heartland
 Jack Dustman & Assoc.
 Kokusai Inc.
M&M Precision System
Mahr Corporation
 Manufactured Gear & Gage
 Miller Industrial Service
Moore Products Co.
National Broach
 NewAge Industries Inc.
 Ono Sokki Technology
 Precision Gage Co.
Profile Engineering
 Progressive Technologies
 Reishauer Corp.
 Roto-Technology Inc.
 Sigma Pool-Liebherr
 Spline Gauges Ltd.
United Tool Supply

Keyseating Machines

Basic Incorporated Group
 Colonial Tool Group Inc.
 Elmass North America
 Mitts & Merrill L.P.
 The Ohio Broach & Machine Co.

Lapping Machines

Basic Incorporated Group
 Bluegrass Precision Machinery
 Engis Corp.
The Gleason Works
 Lapmaster Intl.
 Sigma Pool-Liebherr

Measuring Machines

Alpha Precision Inc.
American Pfauter, L.P.
Basic Incorporated Group
 Best Engineering Co., Inc.
 Bluegrass Precision Machinery
Holroyd Machine
 Krautkramer Branson
Mahr Corporation
 Miller Industrial Service
 Ono Sokki Technology
 Precision Gage Co.
Profile Engineering
 Roto-Technology Inc.

Sigma Pool-Liebherr
 Spline Gauges Ltd.
United Tool Supply

Shaping Machines

American Pfauter, L.P.
Basic Incorporated Group
 Bluegrass Precision Machinery
 Bourm & Koch
 Elmass North America
Fellows Corp.
The Gleason Works
Gleason-Pfauter Maschinenfabrik
 Hermes Machine Tool
Mitsubishi Machine Tool
Parker Industries Inc.
 Sigma Pool-Liebherr
 WMW Machinery

Shaving Machines

American Pfauter, L.P.
Basic Incorporated Group
 Bluegrass Precision Machinery
 Elmass North America
The Gleason Works
Gleason-Pfauter Maschinenfabrik
National Broach

Spline Rolling Machines

Colonial Tool Group Inc.
 General Broach & Eng.
 Micromatic Textron
Mitsubishi Machine Tool
Moore Products Co.
National Broach

Testing Machines

Basic Incorporated Group
 Best Engineering Co., Inc.
Fellows Corp.
The Gleason Works
Holroyd Machine
ITW Heartland
 Krautkramer Branson
 Labeco
M&M Precision Systems
Mahr Corporation
 Manufactured Gear & Gage
 NewAge Industries Inc.
 Ono Sokki Technology
Parker Industries Inc.
 Precision Gage Co.
Profile Engineering
 Sigma Pool-Liebherr

Turning Machines

Basic Incorporated Group
 Bluegrass Precision Machinery
 Hermes Machine Tool
 J&E Hofmann Eng.
 Jack Dustman & Assoc.
 Miller Industrial Service
Mitsubishi Machine Tool
 Sales Consultants
 V & R Associates
 WMW Machinery

Worm Milling Machines

American Pfauter, L.P.
Basic Incorporated Group

Eltech Inc.
 GTI Technologies Inc.
Koepfer America L.L.C.
 Sigma Pool - Liebherr
 WMW Machinery

Other Gear Manufacturing Machines

American Broach—*CNC Broach Sharpeners*
**American Wera Inc.—
 Polygon Cutting (Profiling)**
**Ataka Engineering—
 Cutter Sharpening Machines**
 Cold Forming Technology—*Spline Rolling Automatic Loaders*
**Diamondex—
 Gear Coating Systems**
D.I.G.I.T.—Gear Data Gages
 DoAll—*Sawing Machines & Blades*
**Dyer Company—
 Machine Vision**
 GMI—*Tooth Rounding & Pointing Machines*
 GTI—*Cutter Sharpeners*
**Giddings & Lewis—
 Coordinate Measuring Machines**
**Gleason-Pfauter Maschinenfabrik GmbH—
 Spline Millers & Grinders, Shobbers, Milling Machines**
 Hoglund Technology Corp.—*Computerized Wheel Dressers*
**ITW Heartland—
 Burnishing Machines**
**Ikegai America Corp.—
 Hob Sharpeners**
**Kapp Sales & Service—
 Gear & Form Grinding Machines**
LMT-Fette Inc.—Stow-Rack Millers & Cutters
Mahr Corporation—Hand Held Gear & Spline Inspection Tools
 Manufacturing Technology Inc.—*Friction Welding Machines*
 Mitsubishi Laser—*Laser Cutting Machines*
 NewAge Industries Inc.—
Hardness Testers—Auto Traverse
**Parker Industries, Inc.—
 Cutter Sharpeners**
 Progressive Technologies—
Surface Treatment
 Raycon Corporation—
Laser Welders
 Reishauer Corp.—
Thread and Worm Grinding Machines
**Sytec Corp.—
 End Finishing**

United Tool Supply--Gages
Welduction Corporation--
Induction Heating Equipment

GEAR MATERIALS

Gear Blanks

Accurate Specialties Inc.
Blanchat Machine Co.
Cornell Forge Co.
Dabko Industries Inc.
Dayton Gear & Tool
Disston Precision Inc.
Dura-Bar
EMCO Gears
Elmass North America
The Gear Works--Seattle
Generated Gear & Machine
Globe Gear Co.
Harder Precision Components
Horsburgh & Scott
Howard's Machine Shop
Intech Corp.
L + H Welding & Machine
Lufkin Industries Gear Repair
Milford Gear Works
Mobile Pulley & Machine
Moore Machine & Gear
PIC Design
Penntech

Perry Technology

Portland Forge
Power Eng. & Mfg.
Precipart Corp.
Presrite Corp.
Process Industries
Qualicast Corp.
Rj Link International
Satellite Gear
Schafer Gear Works Inc.
Stock Drive
Products/Sterling Instrument

Trogetec Inc.
Wohlert Corp.
Worrall Grinding Co.

Plastics

Dayton Gear & Tool
The Gear Works--Seattle
Globe Gear Co.
Hochst Celanese Corp.
Howard's Machine Shop
Intech Corp.
Trogetec Inc.

Powdered Metals

Asco Sintering Co.
Burgess-Norton Mfg. Co.
Carbon City Products
The Gear Works--Seattle

Steels

Crucible Service Centers
Dayton Gear & Tool
Disston Precision Inc.
Elmass North America
Forging Specialties
The Gear Works--Seattle
Globe Gear Co.
Impact Strategies Inc.
Latrobe Steel Company
Lovejoy Steel

Company--Charlotte
Lovejoy Steel
Company--Cincinnati
Lovejoy Steel
Company--Streetsboro
Lovejoy Steel
Company--York
Moore Machine & Gear
Trogetec Inc.

Other Materials

Crucible Service Centers--
High Speed Steel For Cutting Tools
Dura-Bar--Continuous Cast Iron Barstock
Intech Corp.--*Plastic/Metal Composite*
Lovejoy Steel
Company--Charlotte, Cincinnati, Streetsboro, York--*Cast Iron*
Portland Forge--*Carbon/Alloy Steel Forgings*
SIFCO Selective Plating--Brush Plated Stop-Off and Wear-in Coatings, Brush Plating Chemicals
Trogetec Inc.--*Special*

GEAR SERVICES

Consulting

Advance Gear & Machine
Aero Gear, Inc.
Aplus Engineering Inc.
Applied Mechaniques
Aston Metallurgical Services

Axicon Technologies
Best Engineering Co., Inc.
Bourn & Koch
C-Dot Engineering
Carbon City Products
Ciateq, A. C.
The Cincinnati Gear Co.
Contour Hardening Inc.
Dabko Industries Inc.
Dayton Gear & Tool
Drive Systems Technology
Dynamic Metal Treating
Engrenas Industriales

Rivera
Fairfield Mfg. Co.
GMI
GW Plastics
Gary P. Mowers, Inc.
Geartech Ltda. -
Tecnologia de Engrenagens

The Gleason Works

Guy Crader Consulting
Horsburgh & Scott
Hy-Mech Systems Inc.
I.S.P.J.A.E.
Impact Strategies Inc.
Intech Corp.
J&E Hofmann Eng.
Jack Dustman & Assoc.
Labeco
McGinty Gear
Manufactured Gear & Gage
Maquinaria Ral, S.A.
Mechanical & Structural Design & Software

Milburn Engineering, Inc.
Milford Gear Works
Moore Machine & Gear
NASA Lewis Research Center

NCADT

Ontario Drive & Gear

P. F. Markey Inc.
Packer Engineering
Pennsylvania Gear Corp.
Power Eng. & Mfg.
Powertrain Engineers
Precision Engineering
Precision Gear Inc.

Profile Engineering

R. Cushman & Associates
Reilly Engineering Inc.
Riley Gear Corp.
SBR Consulting
Sales Consultants
Satellite Gear
Society of Manufacturing Engineers

Software Engineering Service

Spline Gauges Ltd.
Sussex Gear Company
Swiglo Metallurgical Consulting

Technimet Corp.

Tifco Gage & Gear

Trogetec Inc.

U.S. Tech Corp.

Ultron Incorporated

Universal Technical Systems

Van Gerpen-Reece Eng.

Wedin Intl. Inc.

Wes-Tex Gear Inc.

Westech Gear

Cryogenics

American Brazing
Best Engineering Co., Inc.
Horsburgh & Scott
Impact Strategies Inc.

Iron Boud Heat Treating
J&E Hofmann Eng.
Paulo Products Company--
Bessemer

Paulo Products Company--
Kansas City
Paulo Products Company--
Memphis

Paulo Products Company--
Murfreesboro
Paulo Products Company--
Nashville

Paulo Products Company--
St. Louis
Trogetec Inc.

Fault Analysis

American Stress Technologies
Applied Mechaniques
Ashot Ashkelon Indust.
Ashot USA Inc.
Aston Metallurgical
Ciateq, A.C.
The Cincinnati Gear Co.
Dayton Gear & Tool
Drive Systems Technology
Fairfield Mfg. Co.
Horsburgh & Scott
Hy-Mech Systems Inc.
I.S.P.J.A.E.
J&E Hofmann Eng.

KAPP

2870 Wilderness Place
Boulder, CO 80301
FAX: 303-447-1131



KAPP

Sales & Service 303-938-9737

Sales and Service for all **Kapp** and **Niles** Grinding Machines, Accessories, and Tooling

KAPP TECH

303-447-1130

Involute, Modified Involute, and Non-Involute CBN Tools for **Kapp** and **Niles** Machines

• <http://www.kapp-usa.com> •

CIRCLE 165

Induction Heat Treating Equipment

Induction Gear Hardening • Scanners
Ultra-Case • One Shot Hardening
Lift-Rotates • Power Supplies
Automation • Complete Factory Cells
Heat Treating Development

Ajax Magnethermic
CORPORATION

The Way The World Inducts Its Business

1745 Overland Avenue • Warren, OH 44482
Phone: (330) 372-8511 • (800) 547-1527 • Fax: (330) 372-8608

CIRCLE 118

For all your **TOOTH CUTTING** needs
contact **Perry Technology Corporation**

THE GEAR & SPLINE EXPERTS!!

6 Axis CNC Shaping
Tilt Table Shaping
Hobbing - All Sizes
Straight Broaching
Helical Broaching
Keyseating to 36°
Helicoidal Couplings
Complete Machining
Our Large Cache of Tools Saves you \$!

Spur Gears - Up to 48" Dia
Helicals - Internal & External
Face Gears - Spur and Helical
Face Gears - Concave & Convex
Sprockets and Timing Pulleys
Splines & Serrations - All Types
Aircraft Turbine Hub Splicing
Racks - Straight and Helical
Worms and Wheels of All Sizes
Prototype Plastic Gears - FAST



29 Industrial Park Road - New Hartford, CT. 06057
Ph: (860) 738-2525 - FAX: (860) 738-2455

CIRCLE 181

**YOU CAN'T BEAT MOORE FOR HIGH VOLUME
GEAR INSPECTION SYSTEMS.**

Gear gaging experience: For more than 50 years, Moore has been designing and producing quality, reliable gear gaging systems; now offers widest range of functional gear gaging systems.

Gear gaging technical back-up: In the U.S., Moore has over 1,000 employees and a 375,000 square foot manufacturing facility with full engineering services.

Gear gaging advanced electronics: Moore's sister division, Instruments and Controls, provides sophisticated computer hardware and software for process control assistance.

Gear gaging size capabilities: Big enough to handle major programs, but specialized enough to provide personal attention.



Moore Products Co.
Measurements Systems Division
Sumneytown Pike, Spring House, PA 19477
TEL: 215-646-7400 x2352 • FAX: 215-653-0347

CIRCLE 162

Lufkin Industries Gear Repair
 Mechanical & Structural Design & Software
 Milburn Engineering, Inc.
 Modern Industries Inc.
 NASA Lewis Research National Metrology
 Packer Engineering Philadelphia Gear Corp.—Houston
 Powertrain Engineers
 Reilly Engineering Inc.
 Surface Technology, Inc.
 Technimet Corp.
 Trogetec Inc.

Universal Technical Systems
 Wes-Tex Gear Inc.
 Westech Gear

Gear Design

ATA Gears Inc.
 Advance Gear & Machine
 Aero Gear, Inc.
 Allied Devices Corp.
 Aplus Engineering Inc.
 Applied Mechaniques
 Arrow Gear Co.
 Ashot Ashkelon Indust.
 Ashot USA Inc.

Axicon Technologies
 BestMetal Corp.
 Blanchat Machine Co.
 Boston Gear
 C-Dot Engineering
 CMD (UK) Ltd.
 Carbon City Products
 Caterpillar Industrial Products Inc.
 Ciateq, A.C.
 The Cincinnati Gear Co.
 Columbia Gear Co.
 Contour Hardening Inc.
 Cunningham Industries
 Dayton Gear & Tool
 Drive Systems Technology

Dynamic Tool Grinding
 EMCO Gears
 Electra-Gear
 Engranes Industriales Rivera
 Fairfield Mfg. Co.
 GW Plastics
 The Gear Works-Seattle
 Gearesearch Assoc.
 Gears & Drive Systems
 Geartech Ltda. - Tecnologia de Engragenagens
The Gleason Works Global Gear
 Guy Crader Consulting

HMC
 Harder Precision Components
Holroyd Machine
 Horsburgh & Scott
 Hy-Mech Systems Inc.
 I.S.P.J.A.E.
 ITW Spiroid
 Inco Corporation
 Intech Corp.
 J&E Hofmann Eng.
 Kreiter Geartech
 Labeco
 Lufkin Industries Gear Repair
 McGinty Gear
 Maquinaria Ral, S.A.
 Mechanical & Structural Design & Software
 Milburn Engineering, Inc.
 Milford Gear Works
 Milwaukee Gear Company
 Moore Machine & Gear
 NASA Lewis Research O'Neill Gear
Ontario Drive & Gear PC Enterprises
 Packer Engineering
 Pennsylvania Gear Corp.
 Penntech
 Power Eng. & Mfg.
 Powertrain Engineers
 Precipart Corp.
 Precision Engineering
 Qualicast Corp.
 R. Cushman & Associates
 Reilly Engineering Inc.
 Riley Gear Corp.
 SBR Consulting
 Society of Manufacturing Engineers
 Spline Gauges Ltd.
 Sussex Gear Company
 Tifco Gage & Gear
 Trogetec Inc.
 Universal Technical Systems
Van Gerpen-Reece Eng.
 Von Ruden Mfg.
 Wedin Intl. Inc.
 West Industries Inc.
 Westech Gear
 Winzeler Gear
 Xtek Inc.

Drive Systems Technology
 Dynamic Tool Grinding
 EMCO Gears
 Electra-Gear
 Engranes Industriales Rivera
 Fairfield Mfg. Co.
 Federal Gear Corp.
 Gear Research Institute
 The Gear Works-Seattle
 Gearesearch Assoc.
 Gears & Drive Systems
 Geartech Ltda.—Tecnologia de Engragenagens
Global Gear
 Guy Crader Consulting
 Harder Precision Components
Holroyd Machine
 Horsburgh & Scott
 Hy-Mech Systems Inc.
 I.S.P.J.A.E.
 Inco Corporation
 Intech Corp.
 J&E Hofmann Eng.
 Kreiter Geartech
 Labeco
 Lufkin Industries Gear Repair
 Lyon Gear
 Maquinaria Ral, S.A.
 Mechanical & Structural Design & Software
 Milburn Engineering, Inc.
 Milford Gear Works
 Milwaukee Gear Company
 Modern Industries Inc.
 Moore Machine & Gear
 NASA Lewis Research Center
 NCADT
 Nixon Gear
 Nordberg Lokomo OY
 O'Neill Gear
Ontario Drive & Gear
 Packer Engineering
 Patterson Gear & Machine
 Pennsylvania Gear Corp.
 Penntech
 Philadelphia Gear Corp.—Houston
 Power Eng. & Mfg.
 Powertrain Engineers
 Precipart Corp.
 Precision Engineering
 Precision Gear Inc.
Presrite Corp.
 Process Industries
Profile Engineering
 Qualicast Corp.
 R. Cushman & Associates
 Reilly Engineering Inc.
 Riley Gear Corp.
 SBR Consulting
 Society of Manufacturing Engineers
 Software Engineering Service
 Spline Gauges Ltd.
 Stock Drive Products/Sterling Instrument
 Sussex Gear Company
 Tifco Gage & Gear
 Trogetec Inc.
 Universal Technical Systems
Van Gerpen-Reece Eng.

NEW! NOW YOU HAVE ANOTHER CHOICE...

and it's made in AMERICA!



A/W Systems Co. announces that it is now a manufacturing source of spiral gear roughing and finishing cutters and bodies.

We also can manufacture *new* spiral cutter bodies in diameters of 5" through 12" at present.

A/W can also supply roughing and finishing cutters, hardware and replacement parts for most 5"-12" diameter bodies.

Whether it's service or manufacturing, consider us as an alternative source for replacement parts and hardware as well as bodies and cutters.

You'll be in for a pleasant surprise.

NEW! Straight Bevel Cutters.

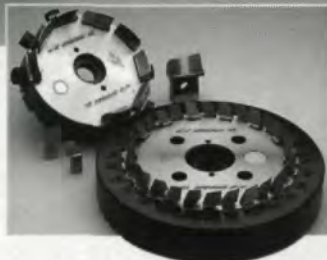

Royal Oak, Michigan 48067
 Tel: (248) 544-3852 • Fax: (248) 544-3922

Wedin Intl. Inc.
Wes-Tex Gear Inc.
West Industries Inc.
Westech Gear
Winzler Gear
Xtek Inc.

Grinding

ACR Industries
Advance Gear & Machine
Aero Gear, Inc.
Aerocom Industries Inc.
Allied Gear Co.
American Broach
Aplus Engineering Inc.
Arrow Gear Co.
Ashot Ashkelon Indust.
Ashot USA Inc.
Axicon Technologies
Blanchat Machine Co.
Boston Gear
Bourn & Koch
Brighton Industries Corp.
Bucyrus International, Inc.
CMD (UK) Ltd.
Caterpillar Industrial Products Inc.
Chardam Gear Co.
The Cincinnati Gear Co.
Dayton Gear & Tool
Disston Precision Inc.
Dyer Company
Engranes Industriales Rivera
Fairfield Mfg. Co.
Federal Gear Corp.
Gear Company of America
The Gear Works-Seattle
Generated Gear & Machine
Hamilton Gear
Hanover Gear Mfg. Co.
Höfler Maschinenbau
Horsburgh & Scott
Inco Corporation
J&E Hofmann Eng.
Kreiter Geartech
Lawler Gear Corp.
Lufkin Industries Gear Repair
Lyon Gear
Meccanica Nova Corp
Merit Gear Corp.
Midwest Gear
Milwaukee Gear Company
Modern Industries Inc.
Modified Gear & Spline
NASA Lewis Research
NCADT
National Broach
Niagara Gear Corp.
Nixon Gear
Nordberg Lokomo OY
Patterson Gear & Machine
Penntech
Perry Technology
Pfauter-Maag Cutting Tools, L.P.
Philadelphia Gear Corp.-Houston
Precision Gear Inc.
Pro-Gear Co. Inc.
Process Industries
The Purdy Corporation
Qualicast Corp.
Riley Gear Corp.
Riverside Spline & Gear
SU America Inc.

Satellite Gear
Tifco Gage & Gear
Trogetec Inc.
USACH Technologies
Wedin Intl. Inc.
Westech Gear
Xtek Inc.

Heat Treating

ACR Industries
Ajax Magnethermic Corp.
American Brazing
American Metal Treating
Aplus Engineering Inc.
Applied Process Inc.
Arrow Gear Co.
Ashot Ashkelon Indust.
Ashot USA Inc.
Axicon Technologies
Blanchat Machine Co.
Boston Gear
Caterpillar Industrial Products Inc.
The Cincinnati Gear Co.
Commercial Steel Treating
Contour Hardening Inc.
Dayton Gear & Tool
Detroit Flame Hardening
Disston Precision Inc.
Dynamic Metal Treating
Engineered Heat Treat
Euclid Heat Treating Co.
FPM Heat Treating
Fairfield Mfg. Co.
Fellows Corp.
Foote-Jones/Illinois Gear
Gear Company of America
The Gleason Works
Hamilton Gear
Harder Precision Components
Horsburgh & Scott
Hudapack Metal Treating-Addison
Hudapack Metal Treating-Elkhorn
Impact Strategies Inc.
Iron Bound Heat Treating
J&E Hofmann Eng.
Kolene Corporation
Kreiter Geartech
Lufkin Industries Gear Repair
Merit Gear Corp.
Milwaukee Gear Company
Modern Industries Inc.
Molon Gear & Shaft
NASA Lewis Research Center
National Broach
Nordberg Lokomo OY
Patterson Gear & Machine
Paulo Products Company-Bessemer
Paulo Products Company-Kansas City
Paulo Products Company-Memphis
Paulo Products Company-Murfreesboro
Paulo Products Company-Nashville
Paulo Products Company-St. Louis
Penn Machine Company
Pennsylvania Gear Corp.
Penntech
Pfauter-Maag Cutting

Tools, L.P.
Philadelphia Gear Corp.-Houston
Pillar Industries
Progressive Engineering
Qualicast Corp.
Richter Precision Inc.
Satellite Gear
Shore Metal Technology
Surface Technology, Inc.
TOCCO Inc.
Trogetec Inc.
U. S. Axle Inc.
Welduction Corporation
West Industries Inc.
Westech Gear
Xtek Inc.

Inspection

ACR Industries
Advance Gear & Machine
Aerocom Industries Inc.
Allied Devices Corp.
Alpha Precision Inc.
American Stress Technologies
Aplus Engineering Inc.
Ashot Ashkelon Indust.
Ashot USA Inc.
Axicon Technologies
Best Engineering Co., Inc.
Blanchat Machine Co.
Bourn & Koch
Brighton Industries Corp.
Bucyrus International, Inc.
The Cincinnati Gear Co.
Contour Hardening Inc.
D.I.G.I.T.
Dayton Gear & Tool
Disston Precision Inc.
Dyer Company
Engranes Industriales Rivera
Euro-Tech Corporation
Fellows Corp.
Forest City Gear Co.
Gear Company of America
The Gear Works-Seattle
Giddings & Lewis
Harder Precision Components
Horsburgh & Scott
Interstate Tool Corp.
Invo Spline Inc.
J&E Hofmann Eng.
Krautkramer Branson
Kreiter Geartech
Lawler Gear Corp.
Lufkin Industries Gear Repair
Lyon Gear
M&M Precision Systems
Manufactured Gear & Gage
Merit Gear Corp.
Midwest Gear
Modern Industries Inc.
NCADT
National Broach
National Metrology
Niagara Gear Corp.
Nixon Gear
PC Enterprises
Patterson Gear & Machine
Paulo Products Company-Kansas City
Penntech
Pennsylvania Gear Corp.



National Broach & Machine Co.

The Industry's Finest Single-Source Supplier Of...

- Broach Tools and Machines
 - Precision Gear Finishing
- Tools and Machines**
- Hobbing ▪ Shaving ▪ Rolling ▪ Honing

17500 Twenty-Three Mile Road, Macomb, Michigan 48044
(810) 263-0100 Fax: (810) 263-4571

CIRCLE 160

PRESRITE NEAR-NET GEARS ARE NEAR PERFECT

If you want the best gears money can buy, invest some time with Presrite. We've already invested millions to build a world-class gear forging plant - a dedicated facility equipped with a state-of-the-art gear lab, high capacity presses, and the latest in sophisticated machinery.

The results are gear-making capabilities that are second to none. We hot-forge gears economically to near-net shapes. Because we can meet such tight tolerances, there's little or no hobbing required. The inherent strength of the forging is maintained while costly roughing and finishing operations can be eliminated.



PRESRITE CORPORATION

3665 East 78th Street, Cleveland, OH 44105
Phone: (216) 441-5990 • Fax: (216) 441-2644
Visit our Web site at www.presrite.com

CIRCLE 187

HOB SHARPENING
(612) 425-5247

Carbide & HSS up to 5" Dia.
Straight Gash,
Sharpened & Inspected
Per AGMA STANDARDS

Quick Turnaround



KORO SHARPENING SERVICE

9530 - 85TH AVENUE NO. • MAPLE GROVE, MN 55369

CIRCLE 176

BARIT INTERNATIONAL CORP.
GEAR CUTTING TOOLS

- ON THE SHELF INVENTORY
- SPECIAL MADE TO ORDER TOOLS

3384 COMMERCIAL AVE.
NORTHBROOK, IL USA 60062-1909
TEL: 847-272-8128
FAX: 847-272-8210

E-mail: barit@enteract.com
or visit us at <http://www.barit.com>



CIRCLE 186

Perry Technology
Philadelphia Gear Corp.—
Houston
Precision Gage Co.
Precision Gear Inc.
Precision Gears Inc.
Pro-Gear Co. Inc.
Process Industries
Profile Engineering
The Purdy Corporation
Qualicast Corp.
Riley Gear Corp.
Riverside Spline & Gear
Roto-Technology Inc.
Satellite Gear
Schafer Gear Works Inc.
Scott Machine Tool Co.
Spline Gauges Ltd.
Tifco Gage & Gear
Trogetec Inc.
Ultron Incorporated
Wedin Intl. Inc.
West Industries Inc.
Westech Gear
Xtek Inc.

Shot Peening

ACR Industries
Ashot Ashkelon Indust.
Ashot USA Inc.
Blanchat Machine Co.
Dayton Gear & Tool
Fairfield Mfg. Co.
Harder Precision
Components
Hydro Honing
Laboratories, Inc.
J&E Hofmann Eng.
Kreiter Geartech
Metal Improvement Co.
NASA Lewis Research
Center
Patterson Gear & Machine
Paulo Products Company—
Memphis
Penntech
Pennsylvania Gear Corp.
Progressive Technologies
U. S. Axle Inc.
West Industries Inc.

Tool Coating

Balzers Tool Coating Inc.
Best Engineering Co., Inc.
Dynamic Metal Treating
Eltech Inc.
Fellows Corp.
General Magnaplate Corp.
The Gleason Works
LMT-Fette Tool
Systems—Brookfield
Multi-Arc Inc.
P. F. Markey Inc.
Pfauter-Maag Cutting
Tools, L.P.
Reid Tool Service Inc.
Richter Precision Inc.
Star Cutter Co.
Surface Technology Corp.

Other Services

ASM International—
Training, Education,
Books
Abrasive Technology Inc.—
Gear Honing
American Brazing—
Brazing

American Broach—
Broach Sharpening
American Metal Treating
—Induction Hardening
American Stress
Technologies—X-Ray
Stress Testing, Non-
destructive Testing
Aston Metallurgical—
Metallurgical/
Mechanical/Chemical
Testing
Bourm & Koch—Hobbing
The Cincinnati Gear Co.—
Gearbox Overhaul &
Field Service
Detroit Flame Hardening—
Flame Hardening
Diamond Black—
Boron Carbide Gear
Coating
Diamonex—Gear Coating
Eltech Inc.—
Hob Sharpening
The Gleason Works—
Tool Sharpening/Tool
Reconditioning
Globe Gear Co.—
Cut Teeth, Reverse
Engineering
Hamer Gear—
Custom Gear
Manufacturing
Horsburgh & Scott—
Gear Drive Rebuilding
(All Manufacturers)
Intech Corp.—
Gear Durability
Calculation
J&E Hofmann Eng.—
On-Site Gear
Installation
James Reid Gear Services—
European Fine Pitch
Machine Specialist
Kolene Corporation—
Molten Salt Bath Heat
Treating
Koro Sharpening
Service—HSS, &
Carbide Hob
Sharpening
McGinty Gear—
Spline Design
Manufacturing Technology—
Friction Weld Gears
Together
Mechanical & Structural
Design & Software—
Gear Failure Analysis
Modern Industries Inc.—
Metallurgical
Evaluation
Moore Products Co.—
Program Management
Gage Systems
NASA Lewis Research
Center— Gear and
Transmission Testing
NCADT—
Conditioned-Based
Maintenance
Nye Lubricants Inc.—
Synthetic Lubricants
for Gears
Packer Engineering—
Failure Analysis &
Testing

Paulo Products Company—
St. Louis—Brazing
Pfauter-Maag Cutting
Tools, L.P.—
Sharpening
Precision Engineering—
Error Analysis of
Backlash—Position
Error for Gears &
Entire System
SIFCO Selective Plating—
Job Shop Plating
Spline Gauges Ltd.—
Plotting & Analysis of
Gear Stresses
Star Cutter Co.—
Hob Sharpening &
Recoating
Surface Technology
Corp.—
Deburring, Gear
Coating
Sussex Gear Company—
Gear Box & Actuator
Design
Tri-Wire, Inc.—
Wire EDM Job Shop
Trogetec Inc.—
Feasibility and/or
conceptual gear
design & mfg.

GEAR SOFTWARE

Custom Software

American Stress
Technologies
Aplus Engineering Inc.
C-Dot Engineering
Ciateq, A.C.
Gearesearch Assoc.
Hoglund Technology
I.S.P.J.A.E.
Koepfer America L.L.C.
Moore Products Co.
Roto-Technology Inc.
Scott Machine Tool Co.
Software Engineering
Service
Trogetec Inc.
Universal Technical
Systems
User Solutions Inc.
Van Gerpen-Reece Eng.

Gear Design Software

AGMA
Bluegrass Precision
Machinery
C-Dot Engineering
Ciateq, A.C.,
Dabko Industries Inc.
Fairfield Mfg. Co.
GW Plastics
Gearesearch Assoc.
Geartech Ltda.—Tecnologia
de Engrenagens
The Gleason Works
I.S.P.J.A.E.
Lemur Enterprises
Mechanical & Structural
Design & Software
NASA Lewis Research
Center
Software Engineering
Service
Stock Drive Prod/Sterling
Instrument

Trogetec Inc.
Universal Technical
Systems
Van Gerpen-Reece Eng.
Inspection Software
Alpha Precision Inc.
American Machinery
Brighton Industries Corp.
GW Plastics
Gearesearch Assoc.
Giddings & Lewis
The Gleason Works
Krautkramer Branson
Lufkin Industries Gear
Repair
M&M Precision Systems
Moore Products Co.
NCADT
Precision Gage Co.
Roto-Technology Inc.
Scott Machine Tool Co.
Sigma Pool-Liebherr
Software Engineering
Service
Trogetec Inc.
Worrall Grinding Co.

Shop Management Software

Best Engineering Co., Inc.
The Gleason Works
JobBoss Software Inc.
Manufacturers Technologies
Power Eng. & Mfg.
Scott Machine Tool Co.
U.S. Tech Corp.
User Solutions Inc.

Other Software

American Gear Mfgs.
Assn.—Gear Rating,
Gear Capacity
American Pfauter, L.P.—
HobTime Software
Bourm & Koch—
Gear Manufacturing
D.I.G.I.T.—
SPC Programs
Drive Systems
Technology—
Software Available
Through Seminars
Euro-Tech Corporation—
Spline Inspection
Software
Extrude Hone—
Surface Finish
Measurement
Software
GB Gear Shop Tools—
Calculations
Gearesearch Assoc.—
Gear Scoring Analysis
Geartech Ltda.—Tecnologia
de Engrenagens—
Mechanical Design
The Gleason Works—
HobTime Software
Hoglund Technology —
Gear Manufacturing
Software License
Krautkramer Branson—
Inspection Data
Management
Meccanic Nova Corp.—
Grinding Machine
Software

Mechanical
& *Structural*
Design & Software
Strength & Fatigue
Analysis Software
NASA Lewis Research
Center—
Bearing/Seal
Normac Inc.—
Form Grinding
Pfauter-Maag Cutting
Tools, L.P.
HobTime
Trogetec Inc.—Shop Floor
Gear Design &
Manufacturing Software
User Solutions Inc.—
Quality
Van Gerpen-Reece Eng.—
Tooling Recycling

GEAR TOOLING & ACCESSORIES

Abrasives

Abrasive Technology Inc.
Best Engineering Co., Inc.
Bluegrass Precision
Machinery
Clipper Diamond Tool Co.
Dianamic Abrasive
Products Inc.
Engis Corp.
Ernst Winter & Son Inc.
Extrude Hone
GMI
Lapmaster Intl.
Meccanica Nova Corp
Meister Grinding Tech.
P. F. Markey Inc.
Redin Corporation
Reishauer Corp.
Rex-Cut Products Inc.
Sidley Diamond Tool Co.
Universal Superabrasives
W. E. Litwin Assoc.

Broaching Tools

American Broach
American Machinery
Apex Broach & Machine
Barit International Corp.
Best Engineering Co., Inc.
Brighton Industries Corp.
Colonial Tool Group Inc.
Detroit Broach Co.
Elmass North America
Fässler
GTI Technologies Inc.
General Broach &
Engineering Co., Inc.
Jack Dustman & Assoc.
Kingsford Broach & Tool
LMT-Fette Tool
Systems—Stow
Miller Industrial Service
National Broach
The Ohio Broach &
Machine Co.
P. F. Markey Inc.
Parker Industries Inc.
Ply-Mar Tool Co
Reid Tool Service Inc.
Ty Miles Inc.

Chamfering Tools

Best Engineering Co., Inc.
Chamfermatic, Inc.

GMI
The Gleason Works
P. F. Markey Inc.
Pfauter-Maag Cutting
Tools, L.P.
Ply-Mar Tool Co
Ravjeet Eng. Specialties
Redin Corporation
Reid Tool Service Inc.
SU America Inc.
Schenck Turner

Deburring Tools

Best Engineering Co., Inc.
Burlytic Systems
Chamfermatic, Inc.
Extrude Hone
The Gleason Works
GMI
JRM International Inc.
Jack Dustman & Assoc.
P. F. Markey Inc.
Pfauter-Maag Cutting
Tools, L.P.
Progressive Technologies
Redin Corporation
Reid Tool Service Inc.
Rex-Cut Products Inc.
SU America Inc.
Schenck Turner

EDM Tooling & Supplies

Bluegrass Precision
Machinery
Charmilles Technologies
Easco-Sparcatron
Extrude Hone
Hangsterfer's Labs
KGK International Corp.
Mecatool USA Ltd.
Perry Technology

Form Grinding Wheels

Abrasive Technology Inc.
Best Engineering Co., Inc.
Bluegrass Precision
Machinery
Brighton Industries Corp.
Clipper Diamond Tool Co.
Dianamic Abrasive
Engis Corp.
Ernst Winter & Son Inc.
The Gleason Works
GMI
Hoglund Technology
Kapp Tech L.P.
Meccanica Nova Corp
Meister Grinding Tech.
P. F. Markey Inc.
Pfauter-Maag Cutting
Tools, L.P.
Sidley Diamond Tool Co.
Star Cutter Co.
Wendt Dunnington

Gages

A/W Systems Company
Automated Precision Inc
Best Engineering Co., Inc.
Colonial Tool Group Inc.
Comtorgage Corp.
D.I.G.I.T.
Dyer Company
Euro-Tech Corporation
Globe Gear Co.
Invo Spline Inc.
JRM International Inc.

M&M Precision Systems
MTI Corporation (Mitutoyo)
Mahr Corporation
Moore Products Co.
P. F. Markey Inc.
Parker Industries Inc.
Perry Technology
Ply-Mar Tool Co
Precision Gage Co.
Reid Tool Service Inc.
Russell, Holbrook & Henderson
Spline Gauges Ltd.
Sytec Corp.
Trogetec Inc.
United Tool Supply
Western Spline Gage

Hobs
Axicon Technologies
Barit International Corp.
Best Engineering Co., Inc.
Chowgule Matrix Hobs
Eltech Inc.
Fellows Corp.
GMI
The Gleason Works
Great Gear Corp.
Interstate Tool Corp.
JRM International Inc.
Koepfer America L.L.C.
Kromhard Twist Drill Co.
LMT-Fette Inc.—Stow
LMT-Fette Tool
Systems—Brookfield
Mitsubishi Machine Tool
National Broach
P. F. Markey Inc.
Parker Industries Inc.
Pfauter-Maag Cutting
Tools, L.P.
Ply-Mar Tool Co
Rebco Industrial Products
Reid Tool Service Inc.
Russell, Holbrook & Henderson
SRP Tools Ltd.
SU America Inc.
Sigma Pool-Liebherr
Star Cutter Co.

Keyseat Cutters
Best Engineering Co., Inc.
Colonial Tool Group Inc.
Elmass North America
LMT-Fette Tool
Systems—Brookfield
Mitts & Merrill L.P.
P. F. Markey Inc.
Reid Tool Service Inc.
Star Cutter Co.
Trogetec Inc.
W. E. Litwin Assoc.

Lapping Compounds
Dianamic Abrasive
Engis Corp.
GTI Technologies Inc.
Hangsterfer's Lab
Lapmaster Intl.
National Broach
P. F. Markey Inc.
Reid Tool Service Inc.
Sidley Diamond Tool Co.

Lubricants/Coolants
Abrasive Technology Inc.
D. A. Stuart Co.

DoAll
Engis Corp.
Etna Products Inc.
Hangsterfer's Labs
Houghton International
Klubber Lubrication
Lapmaster Intl.
Lubriplate
Meccanica Nova Corp
P. F. Markey Inc.
Nye Lubricants, Inc.
Texaco Lubricants Co

Shaper Cutters
American Machinery
Barit International Corp.
Best Engineering Co., Inc.
Chowgule Matrix Hobs
Elmass North America
Eltech Inc.
Fellows Corp.
GMI
The Gleason Works
Interstate Tool Corp.
JRM International Inc.
Koepfer America L.L.C.
Kromhard Twist Drill Co.
Mitsubishi Machine Tool
National Broach
P. F. Markey Inc.
Parker Industries Inc.
Pfauter-Maag Cutting
Tools, L.P.
Ply-Mar Tool Co
Rebco Industrial Products
Reid Tool Service Inc.
Russell, Holbrook & Henderson
SRP Tools Ltd.
SU America Inc.
Sigma Pool-Liebherr
Star Cutter Co.
Tri-Wire, Inc.

Shaver Cutters
American Machinery
Barit International Corp.
Best Engineering Co., Inc.
Eltech Inc.
Fellows Corp.
GMI
The Gleason Works
JRM International Inc.
LMT-Fette Tool Systems—
Brookfield
Micromatic Textron
National Broach
P. F. Markey Inc.
Parker Industries Inc.
Pfauter-Maag Cutting
Tools, L.P.
Ply-Mar Tool Co
Rebco Industrial Products
Reid Tool Service Inc.
SRP Tools Ltd.
SU America Inc.
Star Cutter Co.
Tri-Wire, Inc.

Worm Milling Cutters
Barit International Corp.
Best Engineering Co., Inc.
Chowgule Matrix Hobs
GMI
The Gleason Works
Interstate Tool Corp.
JRM International Inc.
Koepfer America L.L.C.

LMT-Fette Tool
Systems—Brookfield
Pfauter-Maag Cutting
Tools, L.P.
Ply-Mar Tool Co
Rebco Industrial Products
Reid Tool Service Inc.
Russell, Holbrook & Henderson
Star Cutter Co.

Other Tooling & Accessories
A/W Systems Company—
Spiral Gear Cutters
Bates Technologies Inc.—
Honing Tools
Best Engineering Co., Inc.—
Maag Type Rack Cutters
Cold Forming Technology—
Spline Rolling Tools
D.I.G.I.T.—
Variable Force Plastic Gear Data Gages
Fässler—Diamond Wheels, Honing Stones
GMI—*Diamond Dressing Tools*
General Broach & Engineering Co., Inc.—
Gear Rolling Tools
The Gleason Works—
Bevel Gear Cutters, Milling Cutters, Band Saw Cutters
Hermes Machine Tool—
Tooling Packages for Specific Machine Tool Purchase

ITW Heartland—
Burnishing Dies
Interstate Tool Corp.—
Rotary Gear Cutters, Maag Cutters
JRM International Inc.—
Hydroloc Clamping
Kapp Tech L.P.—
CBN Gear & Form Grinding Wheels
Koolant Coolers Inc.—
Industrial Liquid Coolers
Manufacturers Technologies Inc.—
Cost Estimating & Process Planning
Mastertech Diamond Products—
CBN Inserts
Mayfran International—
Filtration Equipment, Conveyors, Chip Processing Equipment
Meccanica Nova Corp—
In-/Post-Process Machine Gages
Micromatic Textron—
Spline Rolling Tools
Multi-Arc Inc.—
Coating Services
Oberlin Filter Co.—
Coolant Filtration Equipment

Parker Industries, Inc.—
Cutting Tools for Bevel & Spiral Bevel Gears
Pfauter-Maag Cutting
Tools, L.P.—*Milling Cut-*



Profile Engineering, Inc.
100 River Street
Springfield, VT 05156
Tel: 802-885-9176
Fax: 802-885-6559

- Gear Measuring Solutions
- Composite Gear Analyzer®
- Complete Sales & Service

CIRCLE 133

GEAR DESIGN SOFTWARE & CONSULTING



- Experts in gear & transmission design
- Software for gear design & cutter recycling
- 60 years experience with spur & helical gears

In-house seminars • Phone-fax consulting

VAN GERPEN-REECE ENGINEERING
1502 Grand Blvd. • Cedar Falls, IA 50613
Ph: 319/277-7673 • Fax 319/277-4236

CIRCLE 154

MEASURE GEARS ON THE FACTORY FLOOR



DYER'S 747 ID-OD Gear Measuring Station inspects ID and OD pitch diameters, etc. Many measuring possibilities. Accuracy ± 0.000040", 1µ. Prices start at \$1155. FREE catalog.



PHONE: 800 631-3333
FAX: 717 569-6721
EMAIL: dyer@dyergage.com
WEB: www.dyergage.com
LANCASTER, PA 17601-4966

CIRCLE 120

ONTARIO DRIVE AND GEAR LTD.
Geared to meet your needs.

- PRECISION CUSTOM GEAR CUTTING.
- DESIGN & BUILD CUSTOM GEAR BOXES.
- COMPLETE INVOLUTE GEAR TOOTH CHECKING CAPABILITIES.
- CO-ORDINATE MEASURING MACHINE FACILITY.
- CNC MILLING & TURNING.
- GEAR SHAVING, BROACHING & KEYSEATING.



ODG BOX 280, BLEAMS RD., NEW HAMBURG, ONT. NOB 2G0
TEL: 519 662-2840 FAX: 519 662-2421

CIRCLE 142

FREE Gear Checking Software Demo



Here's your no-risk opportunity to test drive new WinGear[®] double flank roll test and evaluation software from Mahr. This sophisticated yet easy-to-learn Windows[®] 95-compatible program lets you take measurements with a simple mouse-click. Your results may be auto-evaluated according to AGMA, ISO, DIN or user-specified standards, displayed in graphic and tabular form, and output to any Windows-compatible printer.

WinGear Features:

- Total Radial Composite Deviation, F, "
- Tooth-to-Tooth Radial Composite Deviation, f, "
- Radial Runout, F, "
- Radial Center Distance, A_s "
- Test analysis to ISO, AGMA, DIN or user-defined standards
- Data base storage of part parameters and default test procedures

For your FREE WinGear demo, fax your request on company letterhead to: 513/489-2020, or phone: 1-800-969-1331, extension 242.



The Measure of Your Quality

Mahr Corporation
11435 Williamson Road • Cincinnati, OH 45241

Get In Gear With Mahr's Metrology Program

- PC controlled, double flank roll testers
- CNC analytical gear and form testers
- Surface finish test equipment for gear tooth profiles



CIRCLE 122

ers, Bandsaw Cutters
Pitch Templates, Inc.—
*Pitch Template
Inspection Racks*
Portland Forge—*Forgings*
Reishauer Corp.—*Diamond
Dressing Rolls*
SIFCO Selective Plating—
*Brush Plating
Equipment &
Solutions*
S.L. Munson—
*Diamond Gear
Dresser*
SRP Tools Ltd.—*Rotary
Coniflex Cutters*
Sensor Products, Inc.—
*Film used to detect
pressure distribution
and magnitude for
measuring gear tooth
contact.*
Sidley Diamond Tool Co.—
*Diamond Dressing
Tools, Rolls, CBN
Plated Wheels*
Spline Gauges Ltd.—
*Powder Metal Gear &
Spline Form Tool Sets*
Star Cutter Co.—
Thin Coatings
Wendt Dunnington—
*Diamond Dressing
Rollers, Dressing
Equipment*

GEAR WORKHOLDING & FIXTURING

Arbors

Alpha Precision Inc.
American Pfauter, L.P.
Best Engineering Co., Inc.
Bluegrass Precision
Machinery
Boum & Koch
Emuge Corp.
Euro-Tech Corporation
Fellows Corp.
The Gear Works—Seattle
The Gleason Works
Harder Precision
Components
Hermes Machine Tool
Invo Spline Inc.
JRM International Inc.
Jack Dustman & Assoc.
Koepfer America L.L.C.
LeCount Inc.
M&M Precision Systems
Mahr Corporation
Manufactured Gear &
Gage
Maquinaria Ral, S.A.
National Broach
P. F. Markey Inc.
Parker Industries Inc.
Profile Engineering
Reid Tool Service Inc.
Reishauer Corp.
Schunk Inc.
Spline Gauges Ltd.
Tifco Gage & Gear
Toolink Engineering
W. E. Litwin Assoc.
Western Spline Gages

Chucks

Alpha Precision Inc.
American Pfauter, L.P.
Best Engineering Co., Inc.
Bluegrass Precision
Machinery
Brighton Industries Corp.
Emuge Corp.
Euro-Tech Corporation
The Gleason Works
Harder Precision
Components
Hermes Machine Tool
Invo Spline Inc.
Jack Dustman & Assoc.
Manufactured Gear &
Gage
P. F. Markey Inc.
Reid Tool Service Inc.
Schunk Inc.
Star Cutter Co.
Tifco Gage & Gear
Toolink Engineering
Trogetec Inc.
W. E. Litwin Assoc.

Modular Fixtures

Alpha Precision Inc.
Best Engineering Co., Inc.
Bluco Corp.
Bluegrass Precision
Machinery
Emuge Corp.
Hermes Machine Tool
JRM International Inc.
Jack Dustman & Assoc.
Koepfer America L.L.C.
Meccanica Nova Corp
Moore Products Co.
P. F. Markey Inc.
Paul W. Marino Gages Inc.
Scott Machine Tool Co.
Sigma Pool-Liebherr
Sytec Corp.
Trogetec Inc.
W. E. Litwin Assoc.

Toolholders

Alpha Precision Inc.
Best Engineering Co., Inc.
Bluegrass Precision
Machinery Brighton
Industries Corp.
Elmass North America
Emuge Corp.
Euro-Tech Corporation
General Broach & Eng.
Hermes Machine Tool
Interstate Tool Corp.
JRM International Inc.
Jack Dustman & Assoc.
Mahr Corporation
P. F. Markey Inc.
Miller Industrial Services
Reid Tool Service Inc.
SU America Inc.
Schunk Inc.
Toolink Engineering
Trogetec Inc.
W. E. Litwin Assoc.

Other Fixturing & Workholding

A/W Systems Company—
*Cutter Bodies for
Spiral Gears*
Apex Broach & Machine
Broach Holders/Fixtures

Bluco Corp.—*Expanding
Mandrels For Broaches*
Detroit Broach Co.—
*Workholders for
Broaches*
**Euro-Tech Corporation—
Compensating
Washers for Hobs
Meccanica Nova Corp—
*Custom Grinding
Fixturing &
Workholding*
**Schunk Inc.—
Hydraulic Tool
Holders
**Sytec Corp.—
Pitch Line Workhold-
ing Roller Cages
Trogetec Inc.—
*Single & Double
Eccentrics*******

MACHINERY/EQUIP- MENT DISTRIBUTORS

American Machinery—
*Fellows, Apex Broach,
Höfler, Star*
**American Wera Inc.—
Wera Werk, Hurth
Modul, Samag
Ashot USA Inc.—
*Ashot Ashkelon
Industries*
**Ataka Engineering—
Saikuni Mfg. Co., Ltd.**
Best Engineering Co., Inc.—
ITW Heartland
Bluegrass Precision
Machinery—
Mitsubishi
Brighton Industries Corp.—
Normac Inc.
Commercial Gear &
Sprocket—
U.S. Tsubaki
Eltech Inc.—
*Kapp, Niles, SU
America, MGF
GmbH*
**Euro-Tech Corporation—
Frenco, Mytec**
Geartech Ltda. -
*Tecnologia de
Engrenagens—
Hexagon Software*
Harder Precision
Components—
H.P.C. Components
J&E Hofmann Eng.—
Klüber Gear Lubricants
**JRM International Inc.—
Kesel, Saazor,
Schrem**
Meccanica Nova Corp—
Meccanica Nova S.P.A.
Miller Industrial Service—
Tornos Technologies,
National Metrology—
Metronics
Ohio Broach & Machine—
*Tesa Measurement
Systems, UVA
Machine Co.*
**Ontario Drive & Gear—
KTR**
Paul W. Marino Gages
Inc.—*Alufix, Koba-Stet***

Precision Gage Co.—
Vari-Roll gear testers
Reid Tool Service Inc.—
Fellows Corp.
Sigma Pool-Liebherr—
*Liebherr, Lorenz,
Oerlikon, Klingenberg*
Spline Gauges Ltd.—
*M & M Precision
Systems, Inc.*
Tech Sales Inc.—
Arrow Gear Co.
Toolink Engineering—
König-MTM GmbH
V & R Associates—
Laschet & Partner
W. E. Litwin Assoc.—
*Speedgrip Chuck
Professional Tool
Grinding*

TRAINING & EDUCATION

Colleges/Universities

I.S.P.J.A.E.
Mississippi State Univ.
NCADT

Gear Schools

AGMA
American Pfauter, L.P.
Aplus Engineering Inc.
Best Engineering Co., Inc.
Boston Gear
Drive Systems Technology
Educational Systems
Workshops

Euro-Tech Corporation

The Gleason Works
Hane Industrial Training
Hy-Mech Systems Inc.
I.S.P.J.A.E.

Koepfer America L.L.C.
Lufkin Industries Gear
Repair

M & M Precision Systems
Manufacturers

Technologies Inc.

National Broach

**Pfauter-Maag Cutting
Tools, L.P.**

Philadelphia Gear Corp.

Roto-Technology Inc.

Salem Company

Van Gerpen-Reece Eng.

Xtek Inc.

Research Institutions

Ciateq, A.C.
Gear Research Institute
Gearesearch Assoc.
I.S.P.J.A.E.
Mississippi State Univ.
NASA Lewis Research
Center
NCADT

Trade Associations

ASM International
American Gear Mfgs.
Association
Metal Powder Industries
Federation
Society of Manufacturing
Engineers

COMPANY INDEX

Welcome to the 1998 *Gear Technology* Buyers Guide Company Index. Use this index to locate contact information for each company listed in the Product & Services Index. *Gear Technology* advertisers are shown in boldface type. To find the pages on which their ads appear, see the Advertisers Index on page 68.

While we have made every effort to ensure that company names and addresses

are correct, we cannot be held responsible for errors of fact or omission.

If your company is not listed and you would like to be included in next year's directory, e-mail people@geartechnology.com, call 847-437-6604, or fax 847-437-6618 and we will add you to our mailing list.

A

ACR Industries, Inc.
15375 Twenty-Three Mile Road
Macomb MI 48042
Ph: 810-781-2800
Fax: 810-781-0152

ASM International
Materials Information
Materials Park OH 44073
Ph: 216-338-5151
Fax: 216-338-4634
mem-serv@po.asm-intl.org

ATA Gears, Inc.
River Square Plaza
19645 Detroit Rd.
Rocky River OH 44116
Ph: 216-356-0284
Fax: 216-356-0289
postmaster@ata-gears.fi

A/W Systems Company
612 Harrison
P.O. Box 1344
Royal Oak MI 48068-1344
Ph: 248-544-3852
Fax: 248-544-3922

Abrasive Technology Inc.
8400 Green Meadows Dr.
Westerville OH 43081
Ph: 614-548-4100
Fax: 614-548-7617

Accurate Specialties Inc.
N12 W24360 Bluemound Rd.
Waukesha WI 53188
Ph: 414-547-5450
Fax: 414-547-5892

Acme Gear Co., Inc.
130 W. Forest Avenue
Englewood NJ 07631
Ph: 201-568-2245
Fax: 201-568-0282
info@acmegear.com
www.acmegear.com

The Adams Company
100 E. Fourth St.
Dubuque IA 52001
Ph: 319-583-3591
Fax: 319-583-8048

Adobe Precision Gear, Inc.
211 W. Wood
P.O. Box 520
Carlsbad NM 88220
Ph: 505-885-8322
Fax: 505-885-1568
adobe@caverns.com
www.gears.com

Advance Gear & Machine Corp.
16201 S. Broadway
Gardena CA 90248-1906
Ph: 213-770-1951
Fax: 213-770-1955

Aero Gear Co., Inc.
1050 Day Hill Rd.
Windsor CT 06095
Ph: 860-688-0888

Fax: 860-285-8514
buygears@aerogear.com
www.aerogear.com

Aerocom Industries, Inc.
2870 Wilderness Place
P.O. Box 17027
Boulder CO 80301
Ph: 303-440-8106
Fax: 303-440-8108

Ajax Magnethermic Corp.
1745 Overland Ave.
Warren OH 44483
Ph: 330-372-8511
Fax: 330-372-8608

Albro Gear & Instrument
86 Horseblock Rd.
Yaphank NY 11980
Ph: 516-345-0657
Fax: 516-345-0660

Allied Devices Corp.
2365 Milburn Avenue
P.O. Box 501
Baldwin NY 11510
Ph: 516-223-9100
Fax: 516-223-9172
allieddv@linet.com
www.allieddevices.com

Allied Gear Co.
4901 W. Arthington Street
Chicago IL 60644
Ph: 773-287-8742
Fax: 773-287-4720

Alpha Gear Drives Inc.
1440 Howard St.
Elk Grove Village IL 60007
Ph: 847-439-0700
Fax: 847-439-0755
alphagd@idt.net

Alpha Precision Inc.
11500 Rockfield Ct.
Cincinnati OH 45241
Ph: 513-772-4266
Fax: 513-772-6950

Amarillo Gear Co.
2401 Sundown Lane
P.O. Box 1789
Amarillo TX 79105
Ph: 806-622-1273
Fax: 806-622-3258
amagear@arn.net
www.amarillogear.com

Amarillo Gear Co.—Russellville
2401 East 16th Street
P.O. Box 2048
Russellville AR 72811
Ph: 501-967-0844
Fax: 501-967-6221

American Brazing
Paulo Products Co.
4428 Hamann Parkway
Willoughby OH 44094
Ph: 440-946-5900
Fax: 440-946-3091
Memerson@paulo-us.com

American Broach & Machine Co.
4600 Jackson Road
P.O. Box 2030
Ann Arbor MI 48106
Ph: 313-761-5021
Fax: 313-761-7626
amerbroach@aol.com

American Gear & Engineering
38200 Abruzzi Drive
Westland MI 48185
Ph: 313-595-6400
Fax: 313-595-0149

American Gear Mfgs. Assn. (AGMA)
1500 King St., Suite 201
Alexandria VA 22314-2730
Ph: 703-684-0211
Fax: 703-684-0242
franklin@agma.org
www.agma.org

American Machine & Gear Inc.
735 Northwest 16th Ave.
Portland OR 97209
Ph: 800-423-7345
Fax: 505-226-3526

American Machinery
16 Promontory
Dove Canyon CA 92679
Ph: 714-888-8518
Fax: 714-888-8519

American Metal Treating
1043 E. 62nd St.
Cleveland OH 44103
Ph: 216-431-4492
Fax: 216-431-1508

American Metric Corp.
RR 1, Box 1122
Laurens SC 29360
Ph: 864-876-2011
Fax: 864-876-2630
service@ametric.com
www.ametric.com

American Pfauter, L.P.
Gleason Corporation
1351 Windsor Rd.
Loves Park IL 61111-4294
Ph: 815-282-3000
Fax: 815-282-3075
sales@pfauter.com
www.pfauter.com

American Precision Gear Co.
1029 American Street
P.O. Box 906
San Carlos CA 94070
Ph: 800-432-7710
650-595-3664
Fax: 650-595-0388
amgear@pacbell.net
www.amgear.com

American Stress Technologies, Inc.
267 Kappa Drive
Pittsburgh PA 15238
Ph: 412-963-0676
Fax: 412-963-7552
ast@sgi.net

American Wera Inc.
4630 Freedom Dr.
Ann Arbor MI 48108
Ph: 313-973-7800
Fax: 313-973-3053

Andantex USA
1705 Valley Road
Wanamassa NJ 07712
Ph: 800-713-6170
908-493-2812
Fax: 908-493-2949
info@andantex.com
www.andantex.com

Anderson International Corp.
6200 Harvard Ave.
Cleveland OH 44105-4896
Ph: 216-641-1112
Fax: 216-641-0709

Apex Broach & Machine Co.
6401 E. Seven-Mile Rd.
Detroit MI 48234
Ph: 313-891-8600
Fax: 313-891-5083
apex1@apexbroach.com
www.apexbroach.com

Aplus Engineering Inc.
Rm. 521, No. 144
Min Chuan E. Rd. Sec 3
Taipei
Taiwan ROC
Ph: (886)-2-7181811
Fax: (886)-2-5451679

Applied Mechanics
12 Tallarook Close
Toronto NSW 2283
Australia
Ph: (61) 49593573
Fax: (61) 49504538

Applied Process Inc.
12238 Newburgh Rd.
Livonia MI 48150-1046
Ph: 313-464-2030
Fax: 313-464-6314
jkeough@appliedprocess.com
www.appliedprocess.com

Arrow Gear Co.
2301 Curtiss St.
Downers Grove IL 60515
Ph: 630-969-7640
Fax: 630-969-0253
gl@arrowgear.com
www.arrowgear.com

Asco Sintering Co.
2750 S. Garfield Ave.
Commerce CA 90040
Ph: 213-723-5121
Fax: 213-888-9968

Ashot Ashkelon Industries
Gear Systems Division
P.O. Box 21
78100 Ashkelon
Israel
Ph: (972) 767-21525
Fax: (972) 767-28167
udiashot@inter.net.il

Ashot USA Inc.
485 Madison Ave. 14th Floor
New York NY 10017
Ph: 212-223-4050
Fax: 212-223-4156

Aston Metallurgical Services
4201 N. Ravenswood Ave.
Chicago IL 60613
Ph: 773-528-9830
Fax: 773-929-0773
as@mos.com

Astron Midwestern Inc.
6201 East Avenue
Hodgkins IL 60525
Ph: 708-354-2800
Fax: 708-354-2810

Ataka Engineering Co., Ltd.
2-218 Kamiyashiro Meito-Ku
Nagoya Aichi
Japan
Ph: (81) 52-772-0690
Fax: (81) 52-772-0692
ataka@mx.meshnet.or.jp

Automated Precision, Inc
7901-C Cessna Ave.
Gaithersburg MD 20879
Ph: 301-330-8100
Fax: 301-990-8648

Axicon Technologies, LLC
2857 Banksville Road
Pittsburgh, PA 15216
Ph: 412-531-7500
Fax: 412-531-7035
axicon@aol.com

B

Balzars Tool Coating, Inc.
661 Erie Ave.
N. Tonawanda NY 14120
Ph: 716-693-8557
Fax: 716-695-1995

Barit International Corp.
3384 Commercial Ave.
Northbrook IL 60062
Ph: 847-272-8128
Fax: 847-272-8210
people@barit.com
www.barit.com

Basic Incorporated Group
Machine Tools Division
P. O. Box 36276
Los Angeles CA 90036
Ph: 213-933-7191
Fax: 213-933-7487
patrik@loop.com

Bates Technologies, Inc.
9059 Technology Dr.
Fishers IN 46038-0213
Ph: 800-331-6778
317-841-8805
Fax: 317-841-9443
honing@iquest.net
www.batestech.com

Bengal Industries Inc.
11346 53rd St. North
Clearwater FL 33760
Ph: 813-572-4249
Fax: 813-573-2428

Best Engineering Co., Inc.
5600 S. Westridge Dr.
New Berlin WI 53151-0797
Ph: 414-784-2200
Fax: 414-784-2541

BestMetal Corp.
925 Dieckman St.
Woodstock IL 60098

Ph: 815-337-8800
Fax: 815-337-8803

Bevel Gears (India) Pvt. Ltd.
17(B), Sadaramangala Indl. Area
Whitefield Road
Mahadevapura Post
Bangalore 48, Karnataka 560048
India
Ph: (91) 80-8452755
Fax: (91) 80-8452655

Bilgram Gear Co.
Eight Union Hill Rd.
W. Conshohocken PA 19428
Ph: 610-828-7200
Fax: 610-828-9428

Bison Gear & Engineering
3850 Ohio Avenue
St. Charles IL 60174
Ph: 630-377-GEAR (4327)
Fax: 630-377-6777
solutions@bisongear.com
www.bisongear.com

Blanchat Machine Co.
3323 Maple
Wichita KS 67277-2290
Ph: 316-943-4257
Fax: 316-943-0005

Bluco Corp.
509 Weston Ridge Drive
Naperville, IL 60563
Ph: 800-535-0135
630-637-1820
Fax: 630-637-1847
bluco@concentric.net

Bluegrass Precision Machinery
442 Three Springs Rd.
Bowling Green KY 42104
Ph: 502-842-7201
Fax: 502-842-7242

Bonfiglioli Riduttori S.p.A.
Via Giovanni XXIII, 7/A
Lippo di Calderara (BO)
Bologna 40012
Italy
Ph: (39) 51-6673111
Fax: (39) 51-6673106
bonfiglioli@bonfiglioli.com
www.bonfiglioli.com

Bonfiglioli U.K.
Unit 5 Grosvenor Grange
Woolston, Warrington, Cheshire
WA1 4SF
United Kingdom
Ph: (44) 925 852664
Fax: (44) 925 852668

Boonville Mining Services, Inc.
110 W. Division Street
Boonville IN 47601
Ph: 812-897-2512
Fax: 812-897-5236

Boston Gear
Division of IMO Industries
14 Hayward St.
Quincy MA 02171
Ph: 617-328-3300
Fax: 617-479-6238
boston.gear@industry.net
www.boston.gear.industry.net

Bourn & Koch Machine Tool
2500 Kishwaukee St.
Rockford IL 61104
Ph: 815-965-4013
Fax: 815-965-0019
bourn&koch@worldnet.att.net
www.bourn-koch.com

Boxx Gear Mfg.
1314 Central Pkwy SW
Decatur AL 35602
Ph: 205-355-4611
Fax: 205-355-4661

Brighton Industries Corp.
15 Essex Rd.
Paramus NJ 07610
Ph: 201-368-3933
Fax: 201-368-8743

Buckeye Gear Co.
5130 Richmond Rd.
Bedford Hts OH 44146
Ph: 216-292-6424
Fax: 216-292-6454
skidmore@earthlink.net

Bucyrus International, Inc.
1100 Milwaukee Ave.
S. Milwaukee WI 53172
Ph: 414-768-4000
Fax: 414-768-5221
whaag@bucyrus-intl.com

Burgess-Norton Mfg. Co.
737 Peyton Street
Geneva IL 60134
Ph: 630-232-4100
Fax: 630-232-3790
www.burgessnorton.com

Burlytic Systems
100-1 Crawford Street
Leominster MA 01453
Ph: 508-466-9495
Fax: 508-466-9499
www.burlytic.thomasregister.com

C

C-B Gear & Machine, Inc.
4232 Mooney Road
Houston TX 77293
Ph: 800-428-6028
281-449-0777
Fax: 281-590-9127
gearmfg@cbgear.com
www.cbgear.com

C-Dot Engineering
14900 Robinwood
Plymouth MI 48170-2660
Ph: 313-420-2075
Fax: 313-420-1279

CMD (UK) Ltd.
Royd House, Birds Royd Lane
Brighouse, W. Yorkshire HD6 1LQ
United Kingdom
Ph: (44) 1484-401617
Fax: (44) 1484-401618

Calicut Eng. Works Ltd.
26A Camac St.
P. O. Box 9119
Calcutta 700016 India
Ph: (91) 33-2475693
Fax: (91) 33-2476072

Can-Eng Furnaces Ltd.
P.O. Box 235
Niagara Falls NY 14302
Ph: 905-356-1327
Fax: 905-356-1817

Capitol Stampings Corp.
3879 North Richards Street
Milwaukee WI 53212
Ph: 414-963-3500
Fax: 414-963-3516
capitols@execpc.com

Capstan Atlantic
10 Cushing Dr.
Wrentham MA 02093
Ph: 508-384-3100
Fax: 508-384-3196

Carbon City Products
150 Ford Rd.
St. Marys PA 15857
Ph: 814-834-2886
Fax: 814-834-9091
jrb@carboncity.com
www.carboncity.com

Caterpillar Industrial Products Inc.
100 N. E. Adams St.
Peoria IL 61629-4375
Ph: 309-675-5451
Fax: 309-675-6457

Chamfermatic, Inc.
1696 Northrock Ct.
Rockford IL 61103
Ph: 815-636-5082
Fax: 815-877-5787

Channel Power Transmission, Inc.
1275 Bloomfield Ave.
Bldg. 2-14
Fairfield NJ 07004-2708
Ph: 201-244-1750
Fax: 201-244-1746
info@channelpower.com
www.channelpower.com

Chardam Gear Co.
40810 Brentwood
Sterling Heights MI 48310
Ph: 810-795-8900
Fax: 810-795-8908

Charles Bond Co.
1035 Louis Dr.
Warminster PA 18974
Ph: 800-922-0125
Fax: 215-957-7999

Charmilles Technologies Corp.
560 Bond St.
Lincolnshire IL 60069-4224
Ph: 847-913-5300
Fax: 847-913-5340

Chicago Gear-D. O. James
2823 W. Fulton St.
Chicago IL 60612
Ph: 773-638-0508
Fax: 773-638-7161
jswell@ameritech.net
www.chicagogear-dojames.com

Chicago Gear Works
1805 S. 55th Ave.
Cicero IL 60804
Ph: 708-863-2700
Fax: 708-863-2749

Chowgule Matrix Hobs Ltd.
26-A I D A
Patancheru, Medak 502 319
India
Ph: (91) 8453-40305
Fax: (91) 8453-40508

Ciateq, A.C.
Mechanical Transmissions Div.
Retablo 150
Queretaro 76150
Mexico
Ph: (52) 4216808
Fax: (52) 42169963
rodlop@ciateq.mx

The Cincinnati Gear Company
5657 Wooster Pike
Cincinnati OH 45227
Ph: 513-271-7700
Fax: 513-271-0049
cintigear@worldnet.att.net

Circle Gear & Machine Company, Inc.
1501 S. 55th Court
Cicero IL 60804
Ph: 708-652-1000

Fax: 708-652-1100
 cirkgear@circlegear.com
 www.circlegear.com

Clipper Diamond Tool Co.
 47-16 Austell Pl.
 Long Island City NY 11101
 Ph: 718-392-3671
 Fax: 718-392-4124

Cloyes Gear & Products Inc.
 615 West Walnut
 Paris AK 72855
 Ph: 501-963-2105
 Fax: 501-963-3033

Cold Forming Technology, Inc.
 6556 Arrow Drive
 Sterling Heights MI 48314
 Ph: 810-254-4600
 Fax: 810-254-4944

Colonial Tool Group Inc.
 5505 Concorde
 Detroit MI 48211
 Ph: 313-965-8680
 Fax: 519-253-5911
 bmfroats@mnsi.net

Columbia Gear Co.
 530 County Road 50
 Avon MN 56310
 Ph: 320-356-7301
 Fax: 320-356-2131

Commercial Gear & Sprocket
 618 Washington Street
 E. Walpole MA 02032
 Ph: 800-491-1073
 Fax: 508-668-1073

Commercial Steel Treating Corp.
 31440 Stephenson Highway
 Madison Heights MI 48071
 Ph: 248-588-3300
 Fax: 248-588-3534
 craigh@commercialsteel.com

Comtorage Corporation
 58 N.S. Industrial Drive
 P.O. Box 1217
 Slatersville RI 02876
 Ph: 401-765-0900
 Fax: 401-765-2846

Cone Drive Operations
 Division of Textron Inc.
 240 E. 12th Street
 P.O. Box 272
 Traverse City MI 49685-0272
 Ph: 616-946-8410
 Fax: 616-946-0235

Contour Hardening, Inc.
 7898 Zionsville Rd.
 Indianapolis IN 46268
 Ph: 317-876-1530
 Fax: 317-879-2484

Cornell Forge Co.
 6666 W. 66th St.
 Chicago IL 60638
 Ph: 773-767-4242
 Fax: 773-767-9443

Crown Gear B.V.
 Buursterstraat 200
 Enschede NL-7544 RG
 Netherlands
 Ph: (31) 53-477-3622
 Fax: (31) 53-477-9147

Crucible Service Centers
 5639 W. Genesee St.
 Camillus NY 13031-0991
 Ph: 315-487-0800
 Fax: 315-487-4028
 Cunningham Industries

102 Lincoln Ave.
 Stamford CT 06902
 Ph: 203-324-2942
 Fax: 203-324-6039

Curtis Machine Co. Inc.
 2500 East Trail
 P.O. Box 700
 Dodge City KS 67801
 Ph: 316-227-7164
 Fax: 316-227-2971
 curtis@curtismachine.com
 www.curtismachine.com

Cyclo Transmissions Ltd.
 Gearbox Division
 At Post-Pat Kahl, Tal/Dist
 Satara Maharashtra 415011
 India
 Ph: (91) 6262-31931
 Fax: (91) 6262-30185

D. A. Stuart Co.
 Metalworking Division
 7575 Plaza Court
 Willowbrook IL 60521
 Ph: 630-655-4595
 Fax: 630-655-1088

D.I.G.I.T.
 275 Conover Drive
 Franklin OH 45005
 Ph: 513-746-3800
 Fax: 513-746-5103
 digit@erinet.com

Dabko Industries Inc.
 61 E. Main St.
 Forestville CT 06010
 Ph: 800-437-3398
 Fax: 203-583-6902

Davall Gear Company Ltd.
 Welham Green
 Hatfield, Hertfordshire AL9 7JB
 England
 Ph: (44) 1707-265432
 Fax: (44) 1707-268536
 davall@dial.pipex.com

Dayton Gear & Tool
 500 Fame Rd.
 Dayton OH 45449
 Ph: 513-866-4327
 Fax: 513-866-0408
 dgear@rcinet.com

Dearborn Gear & Tool Co.
 4300 Cabot
 Detroit MI 48210
 Ph: 313-581-3111
 Fax: 313-581-3115

Delroyd Worm Gear
 Div. of IMO Industries
 121 First Ave.
 Trenton NJ 08650
 Ph: 609-890-6800
 Fax: 609-890-1876

Detroit Broach Co.
 431 S. Buncombe Rd.
 Greer SC 29651
 Ph: 864-879-7641
 Fax: 864-879-7693

Detroit Flame Hardening
 17644 Mt. Elliott
 Detroit MI 48212
 Ph: 313-891-2936
 Fax: 313-891-3150

Diacraft, Inc.
 9033 General Drive
 Plymouth MI 48170
 Ph: 313-459-8190
 Fax: 313-455-6573

Spiral bevel gears up to 100 inches in diameter. Manufactured for quiet operation and durability to meet exact production requirements.

ASK FOR AMARILLO. YOU CAN COUNT ON IT.

AMARILLO GEAR COMPANY

P.O. Box 1789 806/622-1273
 Amarillo, Texas 79105 Fax 806/622-3258

CIRCLE 107

MANUFACTURER OF HOBS, MILLING CUTTERS,
 PRESSURE COOLANT AND NON-COOLANT DRILLS & REAMERS.

APPLY THIN COATINGS OF TiN, Ti(C,N), (Ti,Al)N, CrN
 HOB SHARPENING AND COATING SERVICE
 CARBIDE PREFORMS
 CNC SHARPENING MACHINES

STAR CUTTER CELEBRATING 70TH ANNIVERSARY, 1927-1997

STAR CUTTER CO.
 23461 INDUSTRIAL PARK DRIVE
 FARMINGTON HILLS, MI 48335
 MAILING ADDRESS: P.O. BOX 376, FARMINGTON, MICHIGAN 48332-0376
 Phone: (248) 474-8200 • Fax: (248) 474-9518



CIRCLE 182

The World Leader in
 Screw Rotor Manufacturing Technology

- Range of CNC Thread Grinding Machines
- Advanced Thread Milling Centers
- Tool Profile Management Centers
- Automatic Rotor Analysis Center
- Co-Pro Computer Aided Rotor Cutter Production
- Conturo-Automatic Deburring Center
- Sub-Contract Rotor Manufacture



Harbour Lane North, Milnrow, Rochdale, OL16 3LQ England
 TEL: +44 (0) 1706 526590 FAX: +44 (0) 1706 353350

CIRCLE 179

FELLOWS® Gear Manufacturing Equipment

Leaders in Precision and Performance

- CNC Gear Shaping Machines
- Cutting Tools
- Cutter Sharpening & Re-Coating
- Remanufacture/Rebuild, CNC Retrofit

Fellows Corporation, Springfield VT
 Tel: 802-886-8333 FAX: 802-886-2700

CIRCLE 125

Diamond Black
100 Somerset Dr.
P. O. Box 190
Conover NC 28613
Ph: 800-368-9968
Fax: 704-322-4636

Dianamic Abrasive Products, Inc.
2566 Industrial Row
Troy MI 48084
Ph: 248-280-1185
Fax: 248-280-2733
dianamic@aol.com
www.dianamic.com

Diamonex® Diamond Film Coatings
A Unit of Monsanto
7331 William Ave.
Allentown PA 18106
Ph: 610-366-7131
Fax: 610-366-7144
jrogers-diamonex@nni.com
www.diamonex.com

Disston Precision, Inc.
6795 State Rd.
Philadelphia PA 19135
Ph: 215-338-1200
Fax: 215-338-7060

DoAll
254 North Laurel Avenue
Des Plaines IL 60016-4398
Ph: 800-92-DO ALL
Fax: 847-699-7524
info@doall.com
www.doall.com

Drive Systems Technology
24 Marlborough Ln.
Glen Mills PA 19342-1519
Ph: 610-358-0785
Fax: 610-358-2776

Dura-Bar
2100 W. Lake Shore Dr.
Woodstock IL 60098
Ph: 815-338-7800
Fax: 815-338-1549
sales@dura-bar.com

Dyer Company
1500 McGovernville Rd.
P.O. Box 4966
Lancaster PA 17604-4966
Ph: 800-631-3333
Fax: 717-569-6721
dyer@dyergage.com
www.dyergage.com

Dynagear, Inc.
2500 Curtiss St.
Downers Grove IL 60515
Ph: 630-969-1008
Fax: 630-969-3970

Dynamic Metal Treating Inc.
7784 Ronda Dr.
Canton Twp. MI 48187
Ph: 313-459-8022
Fax: 313-459-7863

Dynamic Tool Grinding Service
872 Ridge Ave.
Lombard IL 60148
Ph: 630-620-5044
Fax: 630-620-0177

E
E.C. Machining, Inc.
8267 S. 86th Court
Justice IL 60458
Ph: 708-496-0116
Fax: 708-496-0213

EMCO Gears
4329 N. Kedzie

Chicago IL 60618
Ph: 773-539-1315
Fax: 773-539-8792
102050.1033@compuserve.com

Easco-Sparcatron
Div. Of Liquid Drive Corp.
10799 Plaza Drive
Whitmore Lake MI 48189
Ph: 313-449-4443
Fax: 313-449-4447

Educational Systems Workshops, Inc.
P.O. Box 472
Dyer IN 46311
Ph: 219-865-1318
Fax: 219-865-2775

Electra-Gear
Division of Regal-Beloit
1110 N. Lemon Street
Anaheim CA 92801
Ph: 714-535-6061
Fax: 714-535-2489

Electrex Ltd. (India)
Power Tools Division
21, D1 Peenya Industrial
Area II Phase
Bangalore 560058
India
Ph: (91) 80-8394477
Fax: (91) 80-8392854

Elmass North America Inc.
N114 W19320 Clinton Dr.
Germantown WI 53022
Ph: 414-255-5644
Fax: 414-255-6509

Eltech Inc.
12660 North Star Dr.
North Royalton OH 44133
Ph: 440-582-8195
Fax: 440-582-8226

Emuge
104 Otis Street
Northborough, MA 01532
Ph: 508-393-1300
Fax: 508-393-1310
emuge@emuge.com
www.emuge.com

Engelhardt Gear Co.
2550 American Lane
Elk Grove Village IL 60007
Ph: 847-766-7070
Fax: 847-766-6937
www.gearmaker.com

Engineered Heat Treat, Inc.
31271 Stephenson Hwy.
Madison Heights MI 48071
Ph: 248-588-5141
Fax: 248-588-6533
www.eht-inc.com

Engis Corp.
105 W. Hintz Rd.
Wheeling IL 60090
Ph: 847-808-9400
Fax: 847-808-9430
jimmillar@compuserve.com

Engranes Industriales Rivera
Apartado Postal 75-094
Mexico City, D.F. 07750
Mexico
Ph: (52) 5-587-8266
Fax: (52) 5-368-3432

Engrecon S.A.
Rod Mal. Rondon KM 42.4
P. O. Box 031
4 Santana de Parmaiba
Sao Paulo 06500-970

Brazil
Ph: (55) 11-424-1777
Fax: (55) 11-424-1627

Equitable Eng. Co.
1840 Austin
Troy MI 48099-1159
248-689-9700
248-689-0281
curvic@eaglequest.com

Ernst Winter & Son Inc.
100 Wilhelm Winter St.
P. O. Box 1006
Travelers Rest SC 29690
Ph: 864-834-4145
Fax: 864-834-3730

Esgard, Inc.
P.O. Drawer 2698
Lafayette LA 70502
Ph: 318-234-6327
Fax: 318-234-0113

Etna Products, Inc.
16824 Park Circle Drive
P.O. Box 609
Chagrin Falls OH 44022
Ph: 440-543-9845
Fax: 440-543-1789
www.etna.com

Euclid Heat Treating Co.
1408 E. 222nd St.
Cleveland OH 44117
Ph: 216-481-8444
Fax: 216-481-3473

Euclid Universal Corp.
7280 Wright Avenue
Bedford OH 44146
Ph: 216-439-6970
Fax: 216-439-5613

Euro-Tech Corporation
14665 W. Lisbon Rd.
Brookfield WI 53005
Ph: 414-781-6777
Fax: 414-781-2822

Extrude Hone
8075 Pennsylvania Avenue
Irwin PA 15642
Ph: 912-863-5900
Fax: 912-863-8759
exhone@extrudehone.com
www.extrude.com

F
FGT Gage & Systems Inc.
2624 S. 162nd St.
New Berlin WI 53151
Ph: 414-827-0558
Fax: 414-782-3210

FPM Heat Treating
1501 S. Lively Blvd.
Elk Grove Village IL 60007
Ph: 847-228-2525
Fax: 847-228-5912

Fairfield Mfg. Co.
U. S. 52 South
P.O. Box 7940
Lafayette IN 47905
Ph: 765-474-3474
Fax: 765-474-2153
www.fairfieldmfg.com

Falk Corp.
P.O. Box 492
Milwaukee WI 53201
Ph: 800-545-5215
Fax: 414-937-4359

Fässler
11782 N. Maple Rd.
Germantown WI 53022

Ph: 414-255-0695
Fax: 414-255-9676
fassler@execpc.com

Fayscott Co.
225 Spring St.
Dexter ME 04930
Ph: 207-924-7331
Fax: 207-924-5510

Federal Gear Corp.
38134 Western Pkwy. Unit #1
Willoughby OH 44094
Ph: 216-946-4327
Fax: 216-946-8018

Fellows Corp.
Precision Dr.
Springfield VT 05156
Ph: 802-886-8333
Fax: 802-886-2700

Fleet Tools Ltd.
Unit K, Holder Road
Aldershot, Hampshire GU12 4RH
England
Ph: (44) 1252-23040
Fax: (44) 1252-319350
106131.146@compuserve.com

Flender Corporation
950 Tollgate Road
Elgin IL 60123
Ph: 847-931-1990
Fax: 847-931-0711
joesitta@flenderusa.com
www.flenderusa.com

Flender-Graffenstaden Corp.
1589 Aztec Ln.
Mount Pleasant SC 29464
Ph: 803-856-0108
Fax: 803-856-0104
w.p.crosher@compuserve.com

Foote-Jones/Illinois Gear
Div. of Regal-Beloit
2102 N. Natchez
Chicago IL 60707
Ph: 773-622-8000
Fax: 773-622-8176

Forest City Gear Co., Inc.
11715 Main St.
Roscoe IL 61073
Ph: 815-623-2168
Fax: 815-623-6620
fyong@fcg.com
www.fcgear.com

Forging Specialties
12600 Beech Daly Road
Detroit MI 48239-2455
Ph: 313-535-8500
Fax: 313-534-0988
opendie@aol.com
www.forgingspecialties.com

Franke Gear Works Inc.
4401 N. Ravenswood Ave.
Chicago IL 60640
Ph: 800-311-8425
Fax: 800-311-8426

G
GB Gear Shop Tools
2688 Sweet Springs St.
Deltona FL 32738
Ph: 904-532-9787
geneb@bigfoot.com

GMI
6709 Ivandale Rd.
P.O. Box 31038
Independence OH 44131-0038
Ph: 216-642-0230
Fax: 216-642-0231

GTI Technologies Inc.
128 Long Hill Cross Road
Shelton CT 06484
Ph: 203-929-2200
Fax: 203-929-0074
info@gti-usa.com
www.gti-usa.com

GW Plastics Inc.
Pleasant St.
P.O. Box 50
Bethel VT 05032
Ph: 802-234-9941
Fax: 802-234-9940
www.gwplastics.com

Gajra Gears Ltd.
Station Road
Dewas, Madhya Pradesh 455 001
India
Ph: (91) 7272-75597
Fax: (91) 7272-75596

Gary P. Mowers, Inc.
2797 E. Rude St.
Weedsport NY 13166-9766
Ph: 315-834-8823
Fax: 315-834-8824

Gear Company of America
14300 Lorain Ave.
Cleveland OH 44111
Ph: 216-671-5400
Fax: 216-671-5825

Gear Products Inc.
1111 N. 161st East Avenue
Tulsa OK 74116-4098
Ph: 918-234-3044
Fax: 918-234-3455
billj@gearproducts.com
www.gearproducts.com

Gear Research Institute
Applied Research Center
Pennsylvania State University
P. O. Box 30
State College PA 16804-0030
Ph: 814-865-8207
Fax: 814-863-1183
sbr1@psu.edu

Gear Systems Division
Leeson Electric Corp.
23400 Apollo Ct.
Lake Villa IL 60046
Ph: 847-356-1606
Fax: 847-356-1631

The Gear Works-Seattle, Inc.
500 S. Portland St.
Seattle WA 98108-0886
Ph: 206-762-3333
Fax: 206-762-3704
tgw@thegearworks.com
www.thegearworks.com

Gearesearch Inc.
750 Indian Wells Rd.
Banning CA 92220-5308
Ph: 909-845-5822
73743.1322@compuserve.com

Gears & Drive Systems, Inc.
1364 Welsh Rd.
Spring House PA 19477-0109
Ph: 215-540-0820
Fax: 215-540-0360
drive@erols.com
www.gears.drive.systems.industry.net

Geartech Ltda. - Tecnologia de
Engrenagens
R. Juiz de Fora, 833/502A
Belo Horizonte, MG 30180 Brazil
Ph: (55) 31-291-0319
Fax: (55) 31-291-0319
rpenchel@net.em.com.br

Geartronics Industries
100 Chelmsford Road
P.O. Box 376
North Billerica MA 01862
Ph: 617-933-1400
Fax: 508-667-3130

General Broach & Engineering Co., Inc.
50325 Patricia
Chesterfield MI 48051
Ph: 810-598-7594
Fax: 810-949-8007

General Gear Corporation
21896 Schmeman Street
Warren MI 48089
Ph: 810-779-9393
Fax: 810-779-9397

General Magnaplate Corp.
1331 Route 1
Linden NJ 07036
Ph: 908-862-6200
Fax: 908-862-6110
info@magnaplate.com
www.magnaplate.com

Generated Gear & Machine
25418 Ryan Rd.
Warren MI 48091
Ph: 810-756-6470
Fax: 810-756-8517

Giddings & Lewis
Sheffield Measurement
721 Springfield St.
Dayton, OH 45401
Ph: 937-254-5377
Fax: 937-254-5054
grockwel@Giddings.com
www.Giddings.com

The Gleason Works
1000 University Ave.
Rochester NY 14692-2970
Ph: 716-473-1000
Fax: 716-461-4348
glalka@frontiernet.net

Gleason-Pfauter
Maschinenfabrik GmbH
Schwieberdinger Str. 87
D-71636 Ludwigsburg
Germany
Ph: (49) 7141-40-40
Fax: (49) 7141-40-45-00

Global Gear
2500 Curtiss St.
Downers Grove, IL 60515
Ph: 800-825-4327
Fax: 630-969-9307
7295533@mci.mail

Globe Gear Co.
550 Virginia Drive
Fort Washington PA 19034
Ph: 215-542-9000
Fax: 800-635-6273
www.globegear.com

Great Gear Co. of Taiwan
115 Bendingwood Circle
Taylors SC 29687
Ph: 864-322-1266
Fax: 864-608-1268
greattaiwangear@worldnet.att.net

Great Lakes Industry, Inc.
P.O. Box 6219
Jackson MI 49204
Ph: 800-968-3153
Fax: 517-784-3154
greatlakes@dmci.net
www.greatlakesind.com

**M&M PRECISION SYSTEMS OFFERS INNOVATIVE
PROCESS CONTROL SOLUTIONS.**

- Complete line of computerized analytical and functional gauging systems.
- M&M's exclusive GearNet™ server automatically shares data for SPC, remote analysis and archiving.
- Wide selection of gear inspection software, including a bevel gear machine correction package.
- Certification to .001 mm, traceable to NIST.
- New models up to 20% faster for greater throughput.

Call M&M Precision Systems at 937/859-8273 or fax 937/859-4452 for further information.

CIRCLE 163



**Surface[®]
Combustion**



Providing the most diverse offering of equipment and support services for heat treating in a wide variety of material processing industries.

SURFACE COMBUSTION, INC.
1700 Indian Wood Circle • P.O. Box 428 • Maumee, OH 43537
Phone: (800) 537-8980, (419) 891-7150 • Fax: (419) 891-7151
Web Site & Email: <http://www.surfacecombustion.com>

CIRCLE 199



**"DIAMOND-LIKE CARBON" THIN FILM
SURFACE COATINGS FOR GEARS**

Coating thickness:	Range: 0.000003" to 0.0003"
Microhardness:	5-35 GPa (500-3,500 Vickers)
Friction coefficient:	< 0.1 in dry sliding conditions
Process temp.:	< 150°C
DLC Roughness:	Conformal, identical to substrate

Technical Contact: Joseph Rogers, Unit Director
7331 William Ave. • Allentown, PA 18106 • Ph: 610-366-7131 • Fax: 7144

- Coating Services, Research & Development Programs
- Vacuum Deposition Equipment Sales & Process Licensing

CIRCLE 194



**SCHREM
Hydraulic Locknuts**

Axial Clamping Devices for the
Gear Industry

JRM International, Inc.

815-282-9330

Applications, Sales & Repair Service

CIRCLE 143

Greenshpon Engineering Works Ltd.
20 Haamelim Street
P.O. Box 10108
Haifa Bay 26110
Israel
Ph: (972) 4-8721187
Fax: (972) 4-8726231
sales@greenshpon.com
www.greenshpon.com

The Grieve Corporation
500 Hart Rd.
Round Lake IL 60073
Ph: 847-546-8225
Fax: 847-546-9210
bandc@interaccess.com

Groschopp
420 15th Street NE
Sioux Center IA 51250-2100
Ph: 800-829-4135
712-722-4135
Fax: 712-722-1445
gro@mtcnet.net
ggg.mtcnet.net

Grove Gear
Div. of Regal-Beloit
1524 15th Avenue
Union Grove WI 53182
Ph: 414-878-1221
Fax: 414-878-1968

Grupos Diferenciales
Portal de Bergara 32
Vitoria 01013
Spain
Ph: (34) 45-260100
Fax: (34) 45-261446
grupos01@saren.es

Guy Crader Consulting
P.O. Box 126
Lake Ariel PA 18436-0126
Ph: 717-689-7452
Fax: 717-689-7452
gerader@aol.com

H
HMC
RR #1 Box 2D8A
Princeton IN 47670
Ph: 812-385-3639
Fax: 812-385-5232
sales@hmcgears.com
www.hmcgears.com

Hamer Gear
10000 Country Road 116 West
Midland TX 79711
Ph: 800-351-1423
Fax: 915-563-2375

Hamilton Gear Inc.
Div. of Standard Machine Ltd.
2318 Faithfull Ave.
Saskatoon, Saskatchewan S7K 1V1
Canada
Ph: 800-329-4327
306-931-3343
Fax: 306-931-4741
www.hamiltongear.com

Hand Screw Machine
17703 Pennsylvania Ave.
Maple Hts. OH 44137
Ph: 216-475-0220

Hane Industrial Training
120 S. Seventh St.
Terre Haute IN 47807
Ph: 812-232-0753
Fax: 812-232-3978

Hangsterfer's Laboratories, Inc.
Ogden Road
Mantua NJ 08051
Ph: 609-468-0216

Fax: 609-468-0200
www.hangsterfers.com

Hanover Gear Mfg. Co.
300 Fame Avenue
Hanover PA 17331
Ph: 717-632-8977
Fax: 717-632-2743
gearstoday@aol.com

Hansvedt EDM, A Hardinge Co.
803 Kettering Park
Urbana IL 61801
Ph: 217-384-5900
Fax: 217-384-0091

Harder Precision Components
1123 Seminole St.
P. O. Box 1405
Clearwater FL 34615
Ph: 813-442-4212
Fax: 813-447-4463
jkatopis@citicom.com

Harmonic Drive Technologies
247 Lynnfield Street
Peabody MA 01960
Ph: 978-532-1800
Fax: 978-532-9406
info@harmonic-drive.com
http://harmonic-drive.com

Harnischfeger
P & H Mining Division
4400 W. National
Milwaukee WI 53201
Ph: 414-671-7684
Fax: 414-671-7309

Hermes Machine Tool Co., Inc.
Five Gardner Rd.
Fairfield NJ 07004
Ph: 888-639-6224
Fax: 973-227-9364
hermes@new-mach.com
www.new-mach.com

Hico
18000 Studebaker Rd. #550
Cerritos CA 90703
Ph: 310-809-5050
Fax: 310-809-5251

Hitachi America Ltd.
Power Industrial Division
660 White Plains Road
Terrytown NY 10591
Ph: 914-524-6640
Fax: 914-883-5388
straka_s@halny.hitachi.com
www.hitachi.com

Hoechst Celanese Corp.
Technical Polymers Division
90 Morris Ave.
Summit NJ 07901
Ph: 800-833-4882
908-598-4000
Fax: 908-598-4330

Höfler Maschinenbau GmbH
Industriestrasse 19
Ettlingen 76258
Germany
Ph: (49) 7243-599-0
Fax: (49) 7243-599-165

Hoglund Technology Corp.
1050 Route 22 West
Lebanon NJ 08833
Ph: 908-236-7794
Fax: 908-236-6826

Holcroft
12068 Market St.
Livonia MI 48150
Ph: 313-591-1000
Fax: 313-591-6443

Holroyd Machine
Harbour Lane North
Milnrow, Rochdale OL16 3LQ
United Kingdom
Ph: (44) 1706 526590
Fax: (44) 1706 353350

Horsburgh & Scott - Cleveland
5114 Hamilton Ave.
Cleveland OH 44114-3985
Ph: 216-431-3900
Fax: 216-432-4850
drives@horsburgh-scott.com

Horsburgh & Scott - Valparaiso
457 S. Campbell Street
Valparaiso IN 46385-6226
Ph: 219-462-4260
Fax: 219-462-5341
www.horsburgh-scott.com

Houghton International Inc.
Madison & Van Buren Ave.
P. O. Box 930
Valley Forge PA 19482
Ph: 610-666-4000
Fax: 610-666-1376

Howard's Machine Shop
2230 S. Main St.
Carthage MO 64836
Ph: 417-358-7143
Fax: 417-358-3130

Hua Yang Machine Co. Ltd.
No. 5 Torng Lih Rd.
Hsiao Kang Kaohsiung
Taiwan ROC
Ph: (886) 7-8125710
Fax: (886) 7-8318728

Hub City, Inc.
Div. Of Regal-Beloit
2914 Industrial Drive
Aberdeen SD 57402-1089
Ph: 605-225-0360
Fax: 605-225-0567

Hudapack Metal Treating - Addison
824 S. Kay Avenue
Addison IL 60101-4976
Ph: 630-543-6033
Fax: 630-543-8686

Hudapack Metal Treating - Elkhorn
979 Koopman Lane
Elkhorn WI 53121-2203
Ph: 414-723-3345
Fax: 414-723-3752

Hy-Mech Systems Inc.
3641 E. Long Lake Rd.
Traverse City MI 49684
Ph: 616-946-7781

Hydro Honing Laboratories, Inc.
Eight Eastern Park Rd.
P.O. Box 280306
East Hartford CT 06128
Ph: 860-289-4328
Fax: 860-289-2134
shotpeen@ix.netcom.com

I
I.S.P.J.A.E.
Facultad de Ing. Mecanica
Calle 116 S/N CUJAE
Marianao 15
Ciudad Habana
Cuba
Ph: (537) 202267
Fax: (537) 332429
mecanica@cujae.cu

ITW Heartland
1205 36th Ave. West
Alexandria MN 56308
Ph: 320-762-8782

Fax: 320-762-5260
itwgears@gctel.com
www.gctel.com/~itwgears/itwheart.htm

ITW Spiroid
3700 W. Lake Ave.
Glenview IL 60025
Ph: 847-657-5338
Fax: 847-657-5098
jbieber@itwspiroid.com
www.itwspiroid.com

Ikegai America Corp.
2246 N. Palmer #108
Schaumburg IL 60173
Ph: 847-397-3970
Fax: 847-397-7535

Impact Strategies Inc.
P.O. Box 5317
Clinton NJ 08809
Ph: 908-730-9163
Fax: 908-730-8334

Indiana Power Transmission Systems, Inc.
470 E. Northfield Drive
Brownsburg IN 46112
Ph: 800-428-4431
Fax: 317-852-6868
ipts@iquest.net

Indiana Tool/Indiana Gear
6100 Michigan Road
Plymouth IN 46563
Ph: 219-936-2112
Fax: 219-936-7224
dkneidig@itamco.com
www.itamco.com

Inductoheat Inc.
32251 N. Avis Dr.
Madison Hts. MI 48071
Ph: 248-585-9393
Fax: 248-589-1062
info@inductoheat.com
www.inductoheat.com

Insc Corporation
412 Main Street
Groton MA 01450
Ph: 508-448-6368
Fax: 508-448-5155
InscInfo@aol.com
www.inscocorp.com

Intech Corp.
250 Herbert Ave.
Closter NJ 70624
Ph: 201-767-8066
Fax: 201-767-7797

Interstate Tool Corp.
4538 W. 130 St.
Cleveland OH 44135
Ph: 216-671-1077
Fax: 216-671-5431

Invo Spline Inc.
2357 E. Nine-Mile Road
P. O. Box 70
Warren MI 48090
Ph: 810-757-8840
Fax: 810-757-8849

Iron Bound Heat Treating
304 Cox Street
Roselle NJ 07203
Ph: 908-245-0717
Fax: 908-245-6255

J
J&E Hofmann Engineering
Three Alice Street
Bassendean, Perth
Australia
Ph: (61) 9 279-5522
Fax: (61) 9 279-9386
hofmann@tpgi.com.au

Our family of
gear machines
shares a name—



and a whole
lot more.

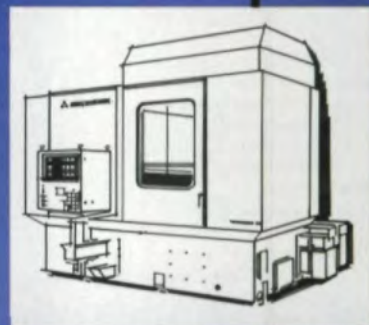
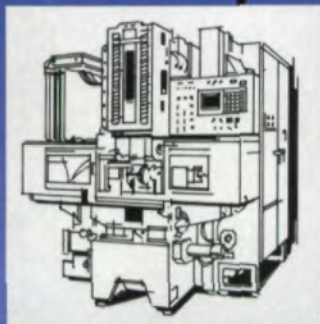
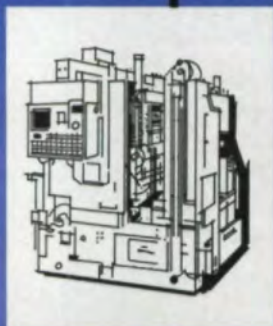
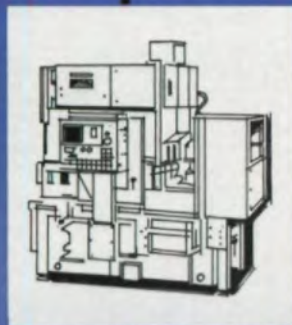

SHAPING

SD15CNC SC63CNC
SC25CNC SC100CNC
SC40CNC

Sophisticated cutting mechanisms give you high productivity for gear shaping needs up to 1 meter diameter.

HOBGING

GD10CNC GC63CNC
GD20CNC GC100CNC
GC25CNC GB-H18CNC
GC40CNC

Get high precision gears—up to 1 meter—with our gear hobbers—fast.

SHAVING

FB30CNC FA45CNC

Cut gears up to 450 mm fast, with simple set up and conversational programming on our gear shavers.

GRINDING

ZG400CNC ZG1000CNC

Our highly precise grinders give you gears that meet the highest world-class standards.

The most complete family of gear cutting machines share Mitsubishi machine construction, Mitsubishi software, and common controls. For the fastest CNC learning curves and the highest quality gears, contact your Mitsubishi representative today.

This is...  **MITSUBISHI
MACHINE TOOLS**

MHI Machine Tool U.S.A., Inc.
907 W. Irving Park Road • Itasca, IL 60143-2023
Phone: (630) 860-4222 • FAX: (630) 860-4233
CIRCLE 109

COMPANY INDEX

JRM International Inc.
1214 Shappert Dr.
Rockford IL 61115
Ph: 815-282-9330
Fax: 815-282-9150

Jack Dustman & Assoc.
3600 Washington Blvd.
Indianapolis IN 46205
Ph: 317-925-3537
Fax: 317-925-3383

Jackson Gear Co.
Rt. #8 Shaler Township
P.O. Box 9508
Pittsburgh PA 15223
Ph: 412-487-8355
Fax: 412-486-8100

Jade Precision Gear Co.
3501-B 8th Avenue South
St. Petersburg FL 33711
Ph: 813-327-2123
Fax: 813-323-4403
universal1@earthlink.net

James Reid Gear Services
102 N. Williams
Westmont IL 60559
Ph: 630-963-9620
Fax: 630-963-9632
reidil@msn.com

JobBoss Software Inc.
7701 York Ave. South
Minneapolis MN 55435
Ph: 800-777-4334
612-831-7182
Fax: 612-831-2811
answers@jobboss.com
www.jobboss.com

K
K.H. Huppert Co. Inc.
16850 S. State St.
South Holland IL 60473-2881
Ph: 708-339-2020
Fax: 708-339-2225

KA-Wood Gear & Machine
32500 Industrial Dr.
Madison Heights MI 48071
Ph: 810-585-8870
Fax: 810-585-3011

KGK International Corp.
901 Deerfield Parkway
Buffalo Grove IL 60089
Ph: 847-465-0160
Fax: 847-465-0181
kgkchi@aol.com

Kapp Sales & Service L.P.
2870 Wilderness Place
Boulder, CO 80301
Ph: 303-938-9737
Fax: 303-447-1131
davidg@kapp-usa.com
www.kapp-usa.com

Kapp Tech L.P.
2870 Wilderness Place
Boulder, CO 80301
Ph: 303-447-1130
Fax: 303-447-1131
toml@kapp-usa.com
www.kapp-usa.com

Keller Machine Co.
315 N. Leavitt St.
Chicago IL 60612
Ph: 312-421-5285
Fax: 312-421-4102

Keystone Powdered Metal Co.
1935 State St.
St. Marys PA 15857-1697
Ph: 814-781-1591

Fax: 814-781-7648
kpmsales@ncentral.com
www.keystonepm.com

Keystone Threaded Products
7621 Old Rockside Road
P.O. Box 31059
Cleveland OH 44131-0059
Ph: 216-524-9626
Fax: 216-524-7132

Kingsford Broach & Tool, Inc.
850 East Boulevard
P.O. Box 2277
Kingsford MI 49802
Ph: 906-774-4917
Fax: 906-774-6981
kbtsales@up.net
www.kingsfordbroach.com

Klubber Lubrication NA, LP
54 Wentworth Ave.
Londonderry NH 03053
Ph: 603-434-7704
Fax: 603-434-8046
www.klubber.com

Koepfer America, L.L.C.
635 Schneider Drive
S. Elgin IL 60177
Ph: 847-931-4121
Fax: 847-931-4192

Kokusai, Inc.
6009 W. 71st St.
Indianapolis IN 46278
Ph: 317-293-6038
Fax: 317-293-6514
kokusai@worldnet.att.net

Kolene Corporation
12890 Westwood Avenue
Detroit MI 48223-3426
Ph: 313-273-9220
Fax: 313-273-6207
75666.2251@compuserve.com
www.kolene.com

Koolant Coolers Inc.
2625 Emerald Dr.
Kalamazoo MI 49001
Ph: 616-349-6800
Fax: 616-349-8951

Koro Sharpening Service
9530 85th Avenue N
Maple Grove MN 55369
Ph: 612-425-5247

Krautkramer Branson
50 Industrial Park Rd.
Lewistown PA 17044
Ph: 717-242-0327
Fax: 717-242-2606
kb-ltn.mhs@compuserve.com

Kreiter Geartech
2530 Garro Street
Houston TX 77003
Ph: 713-237-9793
Fax: 713-237-1209
www.kreiter-geartech.com

Kromhard Twist Drill Co.
1097 Sweitzer Ave.
Akron OH 44301-1382
Ph: 330-535-7129
Fax: 330-535-3729

Krupp Engineering Inc.
8121 Gregory Rd.
Dexter MI 48130
Ph: 313-426-2604
Fax: 313-426-2450

L
L + H Welding & Machine
913 L & J Court
P.O. Box 219
Gillette WY 82716
Ph: 307-682-7238
Fax: 307-686-1646

LMT-Fette, Inc. - Brookfield
3725-I No. 126 St.
Brookfield WI 53005
Ph: 414-783-7606
Fax: 414-783-5043

LMT-Fette, Inc. - Stow
883-E Hampshire Rd.
Stow OH 44224
Ph: 330-940-4052
Fax: 330-940-3598

Labeco
156 E. Harrison St.
Mooresville IN 46158
Ph: 317-831-2990
Fax: 317-831-2978

Lampin Corporation
River Road
P.O. Box 327
Uxbridge MA 01569
Ph: 508-278-2422
Fax: 508-278-7863
scott@mitrpak.com

Lapmaster Intl.
6400 Oakton St.
Morton Grove IL 60053
Ph: 847-967-2975
Fax: 847-967-3903
www.industry.net/lapmaster

Latrobe Steel Company
Division of The Timken Company
P.O. Box 31
Latrobe PA 15650-0031
Ph: 412-537-7711
Fax: 412-537-6316

Lawler Gear Corp.
1320 SE Hamblen Rd.
Lee's Summit MO 64081
Ph: 816-525-0002
Fax: 816-525-1113

LeCount, Inc.
12 DeWitt Dr.
P.O. Box 950
White River Jct. VT 05001-0950
Ph: 802-296-2200
Fax: 802-296-6843
lecount@sover.net
www.sover.net/~lecount

Lemur Enterprises
P.O. Box 2797
Grapevine TX 76099
Ph: 888-481-8755
Fax: 972-304-1604
skinner@lemurent.com
http://lemurent.com

Lincoln Park Engineering
13581 Huron River Drive
Romulus MI 48174-0127
Ph: 313-941-1440
Fax: 313-941-0592

Lovejoy Inc.
2655 Wisconsin Ave.
Downers Grove IL 60515
Ph: 630-852-0500
Fax: 630-852-2120
lovejoy@lovejoy-inc.com
www.lovejoy-inc.com

Lovejoy Steel Company - Charlotte
8011 Pence Road
Charlotte NC 28215

Ph: 800-438-5157
Fax: 704-535-4426

Lovejoy Steel Company - Cincinnati
1761 Elmore Street
Cincinnati OH 45223
Ph: 800-301-2277
Fax: 513-541-1485

Lovejoy Steel Company - Streetsboro
10160 Phillip Parkway
Streetsboro OH 44241
Ph: 800-326-6455
Fax: 216-656-4040

Lovejoy Steel Company - York
180 Roosevelt Avenue
York PA 17404
Ph: 800-828-3722
Fax: 717-843-6560

Lubriplate
129 Lockwood St.
Newark NJ 07105
Ph: 973-589-9150
Fax: 973-589-4432
info@lubriplate.com
www.lubriplate.com

Lufkin Industries Gear Repair
711 Industrial Blvd.
P.O. Box 849
Lufkin TX 75902
Ph: 409-637-5855
Fax: 409-637-5104
gearrepair@lufkin.com
www.lufkin.com

Lyon Gear
4371 Territorial Road
Rochester MI 48306
Ph: 248-651-1751
Fax: 248-652-6548
lyongear@aol.com

M
M&M Precision Systems
300 Progress Rd.
West Carrollton OH 45449
Ph: 937-859-8273
Fax: 937-859-4452

MET
161 Copperfield Drive
Dayton OH 45415
Ph: 513-832-1583
Fax: 513-832-0858
74214.415@compuserve.com

M.J.H. Gear & Tool Co., Inc.
442 W. 49th St.
New York NY 10019
Ph: 212-246-3800
Fax: 212-265-4053

MO Star Gear & Machine
714 Jefferson
Washington MO 63090
Ph: 314-390-3909
Fax: 314-390-3966
mostar@mail.usmo.com

MTI Corporation (Mitutoyo)
965 Corporate Blvd.
Aurora IL 60106
Ph: 630-820-9666
Fax: 630-820-7403
info@mitutoyo.com
www.mitutoyo.com

McEnglevan Industrial Furnace
700 Griggs St.
Danville IL 61832
Ph: 217-446-0941
Fax: 217-446-0943/4536
mifco@ix.netcom.com

Power Integrated Pop-up™

Lift/Rotate Induction Heat-Treating System

Radyne's Power Integrated Pop-up™ heat-treat center is a self-contained system for hardening and tempering components in a lift/rotate, submerged quench method to meet the specific needs of the heat treater. A user-friendly machine interface panel and PLC control enable quick and easy setup and operation. An integrated, modern, efficient, transistorized inverter power supply can match a wide variety of heating coils with easy-to-change tuning capacitors and a multitap output isolation transformer.

The lift actuator assembly includes a ball bearing linear way mounted under a stainless steel sink through double lip wave seals. A chrome-plated stainless steel spindle is mounted on a tapered roller bearing, enclosed in a steel housing. The lift mechanism allows load/unload, heat and quench positions.

The Perfect Integration

The combination of Radyne's Power Integrated Pop-up™ and APEX QA™ Quality Assurance system represents the latest in induction heat-treating technology.



RADYNE

Innovators in Induction Heating

1-800-236-8360

211 W. Boden Street
Milwaukee, WI 53207, U.S.A.
(414) 481-8360 • Fax: (414) 481-8303
e-mail: radyne@execpc.com
<http://www.radyne.com>

COMPANY INDEX

McGinty Gear
11050 McKeese Rd.
Suttons Bay MI 49682
Ph: 616-271-4153
Fax: 616-271-4177

Mahr Corporation
11455 Williamson Road
Cincinnati OH 45241
Ph: 513-489-6116
Fax: 513-489-6302

Makino
7680 Innovation Way
Mason OH 45040
Ph: 513-573-7200
Fax: 513-573-7360
www.makino.com

Manufactured Gear & Gage
P.O. Box 7155
Elgin IL 60121
Ph: 630-377-2496
Fax: 630-377-2546

Manufacturers Technologies Inc.
59 Interstate Dr.
West Springfield MA 01089
Ph: 413-733-1972
Fax: 413-739-9250
info@costimator.com
www.costimator.com

Manufacturing Technology Inc.
1702 W. Washington
P.O. Box 3059
South Bend IN 46628
Ph: 219-233-9490
Fax: 219-233-9489

Maquinaria Ral, S.A. de C.V.
Manuel Gonzalez 554
Mexico City, D.F. 06450
Mexico
Ph: (52) 5-547-1361
Fax: (52) 5-547-1363
pramirez@netservice.com.mx

Martin Sprocket & Gear, Inc.
3100 Sprocket Drive
Arlington TX 76015
Ph: 817-258-3000
Fax: 817-258-3351

Mascotech-Braun
19001 Glendale Avenue
Detroit MI 48223
Ph: 313-270-1709
Fax: 313-272-7017

Mastertech Diamond Products
9465 Hamilton Drive
Mentor OH 44060
Ph: 216-352-1112
Fax: 216-352-1113

Mayfran International
6650 Beta Drive
Cleveland OH 44143
Ph: 216-461-4100
Fax: 216-461-0147
sales@mayfran.com
www.mayfran.com

Mecatool USA Ltd.
165 Hansen Ct. #111E
Wood Dale IL 60118
Ph: 630-595-9696
Fax: 630-595-9101

Meccanica Nova Corp.
24371 Catherine Industrial #235
Novi MI 48375
Ph: 248-449-4000
Fax: 248-449-4004
ncnova@aol.com

Mechanical & Structural Design &
Software
4275-29 Rosewood Dr. #180
Pleasanton CA 94588
Ph: 510-455-3210
Fax: 510-734-6701
lkeves@juno.com
<http://205.186.245.11/msd>

Meister Grinding Tech. Corp.
1200 Millbury St. Unit 7F-7G
Worcester MA 01607
Ph: 508-753-0808
Fax: 508-753-4404

Merit Gear Corp.
810 Hudson St.
P. O. Box 486
Antigo WI 54409
Ph: 800-756-3748
Fax: 715-623-2990

Metal Improvement Co.
10 Forest Avenue
Paramus NJ 07652
Ph: 201-843-7800
Fax: 201-843-3460
metalimp@ix.netcom.com
www.metalimprovement.com

Metal Powder Components
325 Jay Street
Coldwater MI 49036
Ph: 517-278-5685
Fax: 517-279-8743
jbtwiggs@orion.branch-co.lib.mi.us
www.mpc.industry.net

Metal Powder Industries Fed.
105 College Rd. East
Princeton NJ 08540-6692
Ph: 609-452-7700
Fax: 609-987-8523
info@mpif.org
www.mpif.org

Micromatic Textron
345 E. 48th St.
Holland MI 49423
Ph: 616-392-1461
Fax: 616-392-1710

Midwest Gear
2182 E. Aurora Rd.
Twinsburg OH 44087
Ph: 216-425-4419
Fax: 216-425-8600

Midwest Gear & Tool
26069 Groesbeck
Warren MI 48089
Ph: 810-776-7580
Fax: 810-776-2322

Milburn Engineering, Inc.
12024 7th N.W.
Seattle WA 98177
Ph: 206-365-2818
Fax: 206-621-6221
amilburn@aol.com

Milford Gear Works
241 Research Drive
Milford CT 06460
Ph: 203-783-9595
Fax: 203-783-9595

Miller Industrial Services Inc.
6611 W. Oklahoma Ave.
Milwaukee WI 53219
Ph: 414-543-4075
Fax: 414-543-4095

Milwaukee Gear Company
5150 N. Port Washington Dr.
Milwaukee WI 53217
Ph: 414-962-3532
Fax: 414-962-2774

Mississippi State Univ.
Mechanical Eng. Department
210 Carpenter Bldg.
Mississippi State MS 39762
Ph: 601-325-7313
Fax: 601-325-7223
jones@meng.msstate.edu

Mitropak Power Transmission Products
River Road
P.O. Box 327
Uxbridge MA 01569
Ph: 508-278-2422
Fax: 508-278-7863
sales@mitropak.com
www.mitropak.com

Mitsubishi Laser
1500 Michael Drive
Wood Dale IL 60191
Ph: 630-860-4210
Fax: 630-860-7824
bandc@interaccess.com
www.mitslaser.com

Mitsubishi Machine Tool
907 W. Irving Park Rd.
Itasca, IL 60143
Ph: 630-860-4222
Fax: 630-860-4223

Mitts & Merrill L.P.
615 Chippewa Road
Harvard IL 60033
Ph: 815-943-3303
Fax: 815-943-3366

Mobile Pulley & Machine Works
905 S. Ann St.
Mobile AL 36633-1947
Ph: 334-432-7631
Fax: 334-432-8364
75357.1513@compuserve.com

Modern Industries Inc.
613 W. 11th Street
P. O. Box 399
Erie PA 16512
Ph: 814-455-8061
Fax: 814-453-4382

Modified Gear & Spline
18300 Mt. Elliott
Detroit MI 48234
Ph: 313-893-3511
Fax: 313-893-6110

Molon Gear & Shaft
335 E. Illinois St.
Palatine IL 60067
Ph: 847-705-0608
Fax: 847-705-8349

Moore Gear Mfg. Co.
Two Hawthorne Dr.
Hermann MO 65041
Ph: 573-486-5415
Fax: 573-486-3487

Moore Machine & Gear, Inc.
10920 N. St. Joseph Ave.
Evansville IN 47720
Ph: 812-963-3074

Moore Products Co.
Gage Division
One Sumneytown Pike
Spring House PA 19477-0900
Ph: 215-646-7400 x 2352
Fax: 215-653-0347
martindj@mooreproducts.com
www.mooreproducts.com

Multi-Arc Inc.
200 Roundhill Dr.
Rockaway NJ 07866
Ph: 973-625-3400

Fax: 973-625-2244
info@multi-arc.com

Murray Brothers Mfg. Co.
7711 W. 99th St.
Hickory Hills IL 60457
Ph: 708-430-8111
Fax: 708-430-8222

N

NASA Lewis Research Center
21000 Brookpark Rd. MS 77-10
Cleveland OH 44135
Ph: 216-433-3915
Fax: 216-433-3954
john.j.coy@lerc.nasa.gov

NCADT
Penn State University
P.O. Box 30
State College PA 16804-0030
Ph: 814-865-8207
Fax: 814-863-1183
gjj1@psu.edu
www.arl.psu.edu/drivetrain_center

Nanchang Gear Works
Engineering Administration Office
Nanchang Jiangxi 330044
China
Ph: (86) 791 3805885 254
Fax: (86) 791 3805757

National Broach & Machine Co.
17500 Twenty-Three Mile Rd.
Macomb MI 48044-1103
Ph: 810-263-0100
Fax: 810-263-4571

National Metrology
11 Stagecoach Ln.
Sunapee NH 03782
Ph: 603-763-5881
Fax: 603-763-3058

NewAge Industries Inc.
2300 Maryland Rd.
Willow Grove PA 19090
Ph: 215-657-6040
Fax: 215-657-1697

Niagara Gear Corp.
941 Military Rd.
Buffalo NY 14217
Ph: 716-874-3131
Fax: 716-874-9003
info@niagaragear.com
www.niagaragear.com

Nissei Corporation of America
8227-G Arrowridge Blvd.
Charlotte NC 28273
Ph: 704-527-9876
Fax: 704-527-9877
nissei1@aol.com

Nixon Gear
Gear Motions, Inc.
1750 Milton Avenue
Syracuse NY 13209
Ph: 315-488-0100
Fax: 315-488-0196

Nord Gear Corporation
800 Nord Drive
Waunakee WI 53597-0367
Ph: 608-849-7300
Fax: 800-373-NORD
nordinfo@nord-us.com
www.nord.com

Nordberg Lokomo OY
Parkano Works
Vanhantalontie 3
FIN 39700 Parkano
Finland
Ph: (358) 204 80144
Fax: (358) 204 80145

COMPANY INDEX

Normac Inc.
 Airport Road Industrial Park
 P.O. Box 69
 Arden NC 28704
 Ph: 704-684-1002
 Fax: 704-684-1384
info@normac.com
www.normac.com

Nuttall Gear Corp.
 2221 Niagara Falls Blvd.
 P. O. Box 1032
 Niagara Falls NY 14302
 Ph: 716-731-5180
 Fax: 716-731-9329

Nye Lubricants Inc.
 12 Howland Rd.
 Fairhaven MA 02719
 Ph: 508-996-6721
 Fax: 508-997-5285
techhelp@nyelubricants.com
www.nyelubricants.com

Oberlin Filter Co.
 404 Pilot Ct.
 Waukesha WI 53188
 Ph: 414-547-4900
 Fax: 414-547-0683

The Ohio Broach & Machine Co.
 35264 Topps Ind. Pkwy
 Willoughby OH 44094-4684
 Ph: 216-946-1040
 Fax: 216-946-0725
sales@ohiobroach.com
www.ohiobroach.com

Ohio Gear
 Div. of Regal-Beloit Corp.
 Old Norris Road
 Liberty SC 29657
 Ph: 864-843-9231
 Fax: 864-843-1276

Okamoto Corp. EDM Div.
 1500 Busch Parkway
 Buffalo Grove IL 60089
 Ph: 847-520-7700
 Fax: 847-520-7980

Oliver Gear
 Div. Of Gear Motions, Inc.
 1140 Niagara Street
 Buffalo NY 14213
 Ph: 716-885-1080
 Fax: 716-885-1145

Omni Gear
 7502 Mesa Road
 Houston, TX 77028
 Ph: 713-635-6331
 713-635-6331
gearomni@flash.net

Omni Gear & Machine
 90 Bissel St.
 Joliet IL 60432
 Ph: 815-723-4327
 Fax: 815-723-9207

O'Neill Gear
 9207 Ivanhoe St.
 Schiller Park IL 60176
 Ph: 847-678-0676
 Fax: 847-678-0784

Ono Sokki Technology Inc.
 2171 Executive Dr. #400
 Addison IL 60101
 Ph: 630-627-9700
 Fax: 630-627-0004

Ontario Drive & Gear
 220 Bleams Rd.
 New Hamburg ON N0B 2G0
 Canada

Ph: 519-662-2840
 Fax: 519-662-2421
donna@odg.com

Orlandi Gear Company
 6566 Sterling Drive South
 Sterling Heights MI 48312
 Ph: 810-264-6700
 Fax: 810-264-3595

Overton Gear & Tool Corp.
 530 Westgate Drive
 Addison IL 60101
 Ph: 630-543-9570
 Fax: 630-543-7440

PC Enterprises
 115 Yonder Lane
 Sedona, AZ 86336
 Ph: 800-437-2368
 Fax: 520-282-3001
pcent@sedona.net

P. F. Markey, Inc.
 2880 Universal Dr.
 Saginaw MI 48603
 Ph: 517-793-0900
 Fax: 517-793-9511
pfm5131@aol.com

PIC Design
 86 Benson Rd.
 P.O. Box 1004
 Middlebury CT 06762-1004
 Ph: 203-758-8272
 Fax: 203-758-8271
info@pic-design.com
www.penton.com/md/mfg/pic

Pacific Industrial Furnace Co.
 26000 Capitol Ave.
 Redford MI 48239-2499
 Ph: 313-937-4130
 Fax: 313-937-1677

Packer Engineering
 1950 N. Washington Street
 P.O. Box 353
 Naperville IL 60566-0353
 Ph: 800-323-0114
 Fax: 630-505-1986
jjs@packereng.com
www.packereng.com

Parker Industries Inc.
 1650 Sycamore Ave.
 Bohemia NY 11716
 Ph: 516-567-1000
 Fax: 516-567-1355

Patterson Gear & Machine
 5876 Sandy Hollow Road
 P.O. Box 7240
 Rockford IL 61126
 Ph: 815-874-4327
 Fax: 815-874-7448

Paul W. Marino Gages Inc.
 21300 MacArthur Blvd.
 Warren MI 48089
 Ph: 810-759-2400
 Fax: 810-759-2423
pmargage@ix.netcom.com
www.netcom.com/~pmargage

Paulo Products Company - Bessemer
 705 N. 22nd Street
 Bessemer AL 35020
 Ph: 205-428-1294
 Fax: 205-425-9841
gmassey@paulo-us.com

Paulo Products Company - Kansas City
 4827 Chelsea Avenue
 Kansas City MO 64130
 Ph: 816-861-7500
 Fax: 816-924-7300

dcoulis@paulo-us.com
Paulo Products Company - Memphis
 1540 Channel Avenue
 Memphis TN 38113
 Ph: 901-948-5523
 Fax: 901-948-7501
dkermick@paulo-us.com

Paulo Products Company - Murfreesboro
 1307 Rutledge Avenue
 Murfreesboro TN 37129
 Ph: 615-896-1385
 Fax: 615-895-9613
jjenkins@paulo-us.com

Paulo Products Company - Nashville
 3206 Ambrose
 Nashville TN 37207
 Ph: 615-228-2526
 Fax: 615-228-2734
epfrommer@paulo-us.com

Paulo Products Company - St. Louis
 5711 W. Park Ave.
 St. Louis MO 63110
 Ph: 314-647-7500
 Fax: 314-647-7518
nprince@paulo-us.com

Penn Machine Company
 106 Station Street
 Johnstown PA 15905
 Ph: 814-288-1547
 Fax: 814-288-2260

Pennsylvania Gear Corp.
 One Cabot Blvd.
 Langhorne PA 19047
 Ph: 215-945-6000
 Fax: 215-945-2052
email@penngear.com
www.penngear.com

Pennsylvania Pressed Metal Inc.
 RR#2 Box 47
 Emporium PA 15834
 Ph: 814-486-3314
 Fax: 814-486-9273

Penntech
 439 Ivyland Road
 Warminster PA 19047
 Ph: 215-674-9766
 Fax: 215-674-5613

Perry Technology Corp.
 29 Industrial Park Rd
 P.O. Box 21
 New Hartford CT 06057
 Ph: 860-738-2525
 Fax: 860-738-2455
perry.tech@snet.net

Pfauter-Maag Cutting Tools, L.P.
 1351 Windsor Rd.
 P. O. Box 2950
 Loves Park IL 61132-2950
 Ph: 815-877-8900
 Fax: 815-877-0264
sales@pmct.com
www.pmct.com

Philadelphia Gear Corp.
 181 S. Gulph Rd.
 King of Prussia PA 19406
 Ph: 610-265-3000
 Fax: 610-337-5637

Philadelphia Gear Corp.
 Philadelphia Gear Services Div.
 4631 Winfield
 Houston TX 77039
 Ph: 713-449-2200
 Fax: 713-449-2294

Pillar Industries
 N92 W15800 Megal Dr.

Menomonee Falls WI 53051
 Ph: 800-558-7733
 Fax: 414-255-0359

Pitch Templates, Inc.
 1718 Sheffield Dr.
 Blue Bell PA 19422
 Ph: 610-279-0443
 Fax: 610-275-9877

Ply-Mar Tool Co.
 1718 Sheffield Dr.
 Blue Bell PA 19422
 Ph: 610-279-0443
 Fax: 610-275-9877

Poly Hi Solidur
 Power Transmission Div.
 18179 SW Boones Ferry Road
 Portland OR 97224
 Ph: 503-620-9314
 Fax: 503-620-9316
conniebrown.phs@worldnet.att.net

Portland Forge
 400 Corporate Dr.
 Lebanon KY 40033
 Ph: 502-692-3554
 Fax: 502-692-1751

Power Eng. & Mfg. Ltd.
 2635 WCF & N Drive
 P.O. Box 4055
 Waterloo IA 50704-4055
 Ph: 319-232-2311
 Fax: 319-232-6100
info@pemltd.com
www.pemltd.com

Powertrain Engineers
 5005 W. Loomis Rd. #102
 Greenfield WI 53220
 Ph: 414-282-4171
 Fax: 414-282-4385
gearbox@compuserve.com
www.idl.com/powertrain

Precipart Corp.
 90 Finn Court
 Farmingdale NY 11735
 Ph: 516-694-3100
 Fax: 516-694-4016
preciprt@concentric.net

Precision Engineering Services
 388 Palmer Ln.
 Pleasantville NY 10570
 Ph: 914-769-3196
 Fax: 914-769-3196

Precision Gage Co.
 6939 W. 59th St.
 Chicago IL 60638
 Ph: 773-586-2121
 Fax: 773-586-2159

Precision Gear Co.
 1900 Midway Dr.
 Twinsburg OH 44087
 Ph: 216-487-0888
 Fax: 216-487-0618

Precision Gear Inc.
 48-09 108th St.
 Corona NY 11368
 Ph: 718-592-7100
 Fax: 718-592-2525
precisiongear@msn.com

Precision Gears Inc.
 N13 W24705 Bluemound Rd.
 Pewaukee WI 53072
 Ph: 414-542-4261
 Fax: 414-542-1592

Presrite Corp.
3665 E. 78th St.
Cleveland OH 44105-2048
Ph: 216-441-5990
Fax: 216-441-2644
info@presrite.com
www.presrite.com

Pro-Gear Company, Inc.
23 Dick Rd.
Depew NY 14043
Ph: 716-684-3811
Fax: 716-684-7717

Process Industries
3860 N. River Rd.
Schiller Park IL 60176
Ph: 847-671-1631
Fax: 847-671-6840

Production Gear & Broach, Inc.
4960 Hudson Drive
Stow OH 44224
Ph: 330-688-5585
Fax: 330-688-7984

Profile Engineering
100 River St.
Springfield VT 05156
Ph: 802-885-9176
Fax: 802-885-6559

Progressive Engineering Co.
2010 E. Main St.
Richmond VA 23223
Ph: 800-868-5457
Fax: 804-780-2230

Progressive Technologies
4201 Patterson SE
Grand Rapids MI 49546
Ph: 616-957-0871
Fax: 616-957-3484
pitsales@ptihome.com

Pulley Manufacturers Inc.
2980 First Street, Bldg.F/G
La Verne CA 91750
Ph: 909-593-8610
Fax: 909-620-1434
pulley@earthlink.net
www.pulleys.com

The Purdy Corporation
586 Hilliard Street
Manchester CT 06040
Ph: 860-649-0000
Fax: 860-645-6293
sales@purdytransmissions.com
www.purdytransmissions.com

Putnam Precision Molding, Inc.
11 Danco Road
Putnam CT 06260
Ph: 860-928-7911
Fax: 860-928-2229

Q

Qualicast Corp.
P.O. Box 122
Broomall PA 19008
Ph: 610-356-7464
Fax: 610-353-7829

Quench Press Specialists, Inc.
4159 Church St.
Roebuck SC 29376
Ph: 864-576-3502
Fax: 864-576-3513
main@quenchpress.com
www.quenchpress.com

R

R. Cushman & Associates, Inc.
32367 W. Eight-Mile Road
Livonia MI 48152
Ph: 810-477-9900
Fax: 810-477-7883

R.L. Wagner & Assoc.
695 Cavalcade Circle
Naperville IL 60540
Ph: 630-961-9200
Fax: 630-961-9917
rlw695@aol.com

Radyne Corporation
211 W. Boden Street
Milwaukee WI 53207
Ph: 414-481-8360
Fax: 414-481-8303
radyne@execpc.com
www.radyne.com

Rapid Gear
1596 Strasburg Road
Kitchener ON N2R 1E9
Canada
Ph: 519-748-4828
Fax: 519-748-5528
rapid@rapidgear.com
www.rapidgear.com

Ravjeet Engineering Specialties Pvt. Ltd.
S-89 MIDC Industrial Area
PO Box 50
Bhosari, Pune 411026
India
Ph: (91) 212-790370
Fax: (91) 212-790740

Rawling Gear, Inc.
Div. Of Gear Motions, Inc.
890 Hartford Turnpike
Shrewsbury MA 01545
Ph: 508-845-6532
Fax: 508-845-6534

Raycon Corporation
2850 S. Industrial Highway #100
Ann Arbor MI 48104
Ph: 313-677-2614
Fax: 313-677-2778

Rebco Industrial Products
450 Ardmore Terrace
Addison IL 60101
Ph: 630-279-7594
Fax: 630-272-8723

Redin Corporation
1817 18th Ave.
Rockford IL 61104
Ph: 815-398-1010
Fax: 815-398-1055

Reid Tool Service Inc.
1900 Commonwealth Ave.
Charlotte NC 28205
Ph: 704-333-3769
Fax: 704-372-6703

Reilly Engineering Inc.
531 Sutliff Rd.
Lisbon IA 52253
Ph: 319-455-2206
Fax: 319-455-2206
p2reilly@aol.com

Reishauer Corp.
1525 Holmes Rd.
Elgin IL 60123
Ph: 847-888-3828
Fax: 847-888-0343
drich@reishauer.com

Reliance Gear Company Ltd.
Rowley Mills, Penistone Road
Lepton, Huddersfield HD8 0LE
United Kingdom
Ph: (44) 1484-601000
Fax: (44) 1484-601001
sales@reliance.co.uk
www.reliance.co.uk

Reliance Gear Corp.
205 S. Factory

Addison IL 60101
Ph: 630-543-6640
Fax: 630-543-0520

Renold Power Transmission Corp.
512 West Crescentville Road
Cincinnati OH 45245
Ph: 800-850-8141
Fax: 513-346-7520

Rex-Cut Products Inc.
960 Airport Rd.
P. O. Box 2109
Fall River MA 02720
Ph: 800-225-8182
Fax: 800-638-8501

Rexnord Corporation
P.O. Box 2022
Milwaukee WI 53201-2022
Ph: 414-643-3000
Fax: 414-643-3078
www.rexnord.com

Richter Precision Inc.
1021 Commercial Avenue
P.O. Box 159
East Petersburg PA 17520
Ph: 717-560-9990
Fax: 717-560-8741

Riley Gear Corp.
One Precision Dr.
St. Augustine FL 32092
Ph: 904-829-5652
Fax: 904-829-5838
www.rileygear.com

Riverside Spline & Gear
1390 S. Parker
P.O. Box 340
Marine City MI 48039
Ph: 800-394-GEAR
810-765-8302
Fax: 810-765-9595

Rj Link International
3741 Publishers Drive
P.O. Box 6939
Rockford IL 61125
Ph: 815-874-8110
Fax: 815-874-8833

Rockwell Automation/Dodge
6040 Ponders Court
Greenville SC 29615
Ph: 864-297-4800
Fax: 864-281-2318
adv@dodge.ra.rockwell.com
www.industry.net/dodge.rockwell.automation

Ronson Gears Pty. Ltd.
18 Teton Court
Highett, Victoria 3190
Australia
Ph: (61) 3-9555-9822
Fax: (61) 3-9555-7480

Roto-Technology Inc.
351 Fame Rd.
Dayton OH 45449
Ph: 513-859-8503
Fax: 513-865-0656
rotomktg@rototech.com
www.rototech.com

Russell, Holbrook & Henderson
Two North St.
Waldwick NJ 07463
Ph: 201-670-4220
Fax: 201-670-4266

Ryle Manufacturing Co.
3116 Holliday
P.O. Box 5347
Wichita Falls TX 76307
Ph: 800-433-0960

Fax: 940-767-4849
quotedesk@rylesprocket.com
www.rylesprocket.com

S

S.L. Munson & Co.
1517 Gregg St.
Columbia SC 29201
Ph: 803-252-3211
Fax: 803-929-0507

SBR Consulting
667 Streeter Brook Road
Little Genesee NY 14754
Ph: 716-928-1234

SIFCO Selective Plating
5708 Schaaf Road
Cleveland OH 44131
Ph: 216-524-0099
Fax: 216-524-6331
info@brushplating.com
www.brushplating.com

SRP Tools Ltd.
Two Sipcot Indl. Complex
Ranipet 632403
India
Ph: (91) 4172-443612
Fax: (91) 4172-44485

STD Precision Gear & Instrument, Inc.
318 Manley Street
Unit #5
W. Bridgewater MA 02379
Ph: 888-STD-GEAR
508-580-0035
Fax: 888-FAX-4STD
508-80-0071
stdgear@aol.com
www.stdgear.com

SU America Inc.
8775 Capital Ave.
Oak Park MI 48237
Ph: 248-548-7177
Fax: 248-548-4443
usas@concentric.net

Salem Company
105 Marlton Road
P.O. Box 306
Woodstown NJ 08098
Ph: 609-769-0056
Fax: 609-769-2048
sally@salemcompany.com
www.salemcompany.com

Sales Consultants
Two Hudson Place
Hoboken NJ 07030
Ph: 201-659-5205
Fax: 201-659-5009

Santasalo Gears Service
3545 McCall Place, Unit B
Doraville GA 30340
Ph: 770-457-3050
Fax: 770-457-0059
sgsga001@avana.net
www.avana.net/mypages/sgsga001

Satellite Gear
5135 Richmond Road
Bedford Heights OH 44146
Ph: 216-514-8668
Fax: 216-514-8671

Schafer Gear Works, Inc.
814 S. Main St.
P.O. Box 986
South Bend IN 46642
Ph: 219-234-4116
Fax: 219-234-4115
www.schafergear.com

Success

**Ajax Induction Heat Treating Solutions
Let Us Provide One For You...**

Pick and Place. Here's an opportunity to lower direct labor costs and have the built in versatility to handle a variety of parts without expensive retooling. Using simple pick and place movements, cylindrical parts can be induction hardened with consistently high quality. Here, reaction shafts are hardened at the rate of 300 parts per hour. Simple yet effective.



ScanPak. A versatile vertical scanner that allows the user to harden shaft-like parts from camshafts to hydraulic pistons, ScanPak is available in nine different configurations, in power ratings up to 800 KW, in frequencies to 50 KHz. Whether you need single spindle, dual spindle, or twin drive, there is a ScanPak exactly suited for you. ScanPak comes equipped with microprocessor-based machine control, integral heat station, and with spindle sizes up to 60".



Ultra-Case gear hardening—your answer to carburizing. Ultra-Case is a high speed method for contour gear hardening. It provides the user with the ability to surface harden gears at production line speeds while at the same time it solves dimensional distortion problems.



Let Ajax help make your next heat treat project a success. Write to: Ajax Magnethermic Corp., 1745 Overland Avenue, Warren, Ohio 44482. Call toll-free 1-800-547-1527, Fax (330) 372-8644 or in Canada call (905) 683-4980.

Ajax Magnethermic
CORPORATION

The Way The World Inducts Its Business.....

WARREN, OHIO USA / TORONTO, CANADA / UNITED KINGDOM / CARACAS, VENEZUELA / SAO PAULO, BRAZIL
SEOUL, KOREA / MELBOURNE, AUSTRALIA / BILBAO, SPAIN / TOKYO, JAPAN / FRASER, MICHIGAN

CIRCLE 117

Schenck Turner
100 Kay Industrial
Orion MI 48359
Ph: 810-377-2100
Fax: 810-377-2744

Schunk Inc.
211 Kitty Hawk Dr.
Morrisville NC 27560
Ph: 919-572-2705
Fax: 919-572-2818
www.schunk-usa.com

Scott Machine Tool Co.
2780 Bert Adams Rd.
Atlanta GA 30339
Ph: 770-432-7300
Fax: 770-432-7500
ryland@crf.com

Sensor Products, Inc.
24 Castle Ridge Park
East Hanover NJ 07936
Ph 800-755-2201
201-884-1755
Fax: 201-884-1699
sensorprod@aol.com
www.jagat.com/spi

Shin Shin Enterprise Corp.
Business Dept.
No. 37 Dayo 5 St.
Taichung 407
Taiwan
Ph: 886-4-323-9266
Fax: 886-4-322-9951
shin02@ms3.hinet.net
www.shintech.com

Shore Metal Technology
5475 Avion Park Drive
Cleveland OH 44143
Ph: 216-473-2020
wjpowe@shoremetal.com
www.shoremetal.com

Sidley Diamond Tool Co.
32320 Ford Rd.
Garden City MI 48135
Ph: 313-261-7970
Fax: 313-261-2028

Sigma Pool-Liebherr
1465 Woodland Dr.
Saline MI 48176
Ph: 313-429-7225
Fax: 313-429-2294

Society of Manufacturing Engineers
One SME Drive
Dearborn MI 48121-0930
Ph: 800-733-4763
Fax: 313-271-2861
baroche@sme.org
www.sme.org

Software Engineering Service
2801 Ridge Ave.
Rockford IL 61103
Ph: 815-963-1760
Fax: 815-963-1760
azimuth180@aol.com

Southern Gear
3685 NW 106th St.
Miami FL 33147
Ph: 305-691-6300
Fax: 305-696-3376

Spline Gauges Ltd.
Picadilly, Kingsbury near Tamworth
Staffs B78 2ER
United Kingdom
Ph: (44) 1827 872771
Fax: (44) 1827 874128

Sri Venkateshwar Gear Wheels
No 5-36/24/A Industrial Estate Road

Kukatpally, Hyderabad, Andhrapradesh
500 037 India
Ph: (91) 40-278385
Fax: (91) 40-278113
duddilla@hdl.vsnl.net.in

St. Marys Carbon Co.
P/M Products Division
State Street
P.O. Box 427
St. Marys PA 15857
Ph: 814-781-7333
Fax: 814-781-6957

Star Cutter Co.
Starcut Sales
23461 Industrial Park Drive
P.O. Box 376
Farmington Hills MI 48332-0376
Ph: 248-474-8200
Fax: 248-474-9518

Sterling Electric, Inc.
16752 Armstrong Avenue
Irvine CA 92606
Ph: 714-474-0520
Fax: 714-474-0543
sales@sterlingelectric.com

Stock Drive Products/Sterling Instrument
2101 Jericho Trnkp.
New Hyde Park NY 11042-5416
Ph: 516-328-3300
Fax: 516-326-8827
support@sdp-si.com
www.sup-si.com

Sumitomo Machinery Corp.
4200 Holland Blvd.
Chesapeake VA 23323-0628
Ph: 757-485-3355
Fax: 757-485-3075
smcmtg@series2000.com
www.smcyclo.com

Surface Combustion Inc.
1700 Indian Wood Circle
P.O. Box 428
Maumee OH 43537
Ph: 800-537-8980
419-891-7150
Fax: 419-891-7151
www.surfacecombustion.com

Surface Technology, Inc.
105 N Gold Drive
P.O. Box 8585
Trenton NJ 08650
Ph: 609-259-0099
Fax: 609-259-0077
surftec@ibm.net
www.surface-technology.com

Sussex Gear Company Inc.
28 Snover Rd.
Lafayette NJ 07848
Ph: 201-579-2060
Fax: 201-579-5501
76061.2017@compuserve.com

Swiglo Metallurgical Consulting
497 Greenbrier Road
Glen Ellyn IL 60137
Ph: 630-469-9559
saswiglo@juno.com

Sytec Corporation
25 Middlesex Turnpike
P. O. Box 721
Essex CT 06426
Ph: 860-767-1322
Fax: 860-767-1345
syncor@mail.snet.net
www.syncor.com

T
TB Wood's Inc.
440 N. Fifth Avenue
Chambersburg PA 17201
Ph: 717-264-7161
Fax: 717-264-6420
info@tbwoods.com
www.tbwoods.com

TOCCO, Inc.
1506 Industrial Blvd.
Boaz AL 35957
Ph: 205-840-2304
Fax: 205-840-2400

Tech Sales Inc.
707 Broce Drive
Blacksburg VA 24060
Ph: 540-552-1765
Fax: 540-552-0613

Technimet Corp.
2345 S. 170th St.
New Berlin WI 53151
Ph: 414-782-6344
Fax: 414-782-3653
technimet@execpc.com

Texaco Lubricants Co
1250 E. Diehl Rd. #108
Naperville IL 60563
Ph: 630-505-2952
Fax: 630-505-2987
gonnedr@texaco.com

Textile Parts & Machine Co. Inc.
1502 West May Avenue
P.O. Box 12305
Gastonia NC 28052
Ph: 704-865-8564
Fax: 704-865-6620
dstewart@textileparts.com
www.textileparts.com

Therm Alliance Co.
701 S. Post Ave.
Detroit MI 48209
Ph: 313-843-1545
Fax: 313-841-1335

Thomson Micron, LLC
50 Alexander Ct.
Ronkonkoma NY 11779
Ph: 516-467-8000
Fax: 516-467-9814

Tifco Gage & Gear
29905 Anthony Dr.
Wixom MI 48393
Ph: 248-624-7900
Fax: 248-624-1260

Toolink Engineering
2870 Wilderness Place
Boulder CO 80301
Ph: 303-938-8570
Fax: 303-938-8572

Torque Transmission
1246 High Street
Fairport Harbor OH 44077
Ph: 216-352-8995
Fax: 216-352-7682
torquetran@aol.com

Tri-Wire, Inc.
2205 Range Road
Rockford IL 61111
Ph: 815-633-7707
Fax: 815-633-7797

Trogetec Inc.
605 E. Washington
Riverton WY 82501
Ph: 307-856-0579
Fax: 307-856-0579
info@trogetec.com
www.trogetec.com

Trojon Gear Inc.
418 San Jose St.
Dayton OH 45403
Ph: 513-254-1737
Fax: 513-254-3029

Ty Miles Inc.
9855 Derby Ln.
Westchester IL 60154
Ph: 708-344-5480
Fax: 708-344-0437
tymiles@aol.com
www.tymiles.com

U
U. S. Axle, Inc.
275 Shoemaker Rd.
Pottstown PA 19464-6433
Ph: 610-323-3800
Fax: 610-970-2010
www.usaxle.thomasregister.com

U.S. Tech Corp.
333 S. Cross St.
Wheaton IL 60187-5405
Ph: 630-668-7886
Fax: 630-668-5076
73073.2625@compuserve.com

USACH Technologies
1515 Commerce Dr.
Elgin IL 60123-9304
Ph: 847-888-0148
Fax: 847-888-0144

Ultron, Incorporated
2845 Benton Rd
Mt. Vernon IL 62864
Ph: 618-244-3303
Fax: 618-244-9655

United States Gear Corporation
9420 Stony Island Avenue
Chicago IL 60617
Ph: 773-375-4900
Fax: 773-375-4557
www.usgear.com

United Tool Supply
851 Ohio Pike
P.O. 54395
Cincinnati OH 45245
Ph: 513-752-6000
Fax: 513-752-5599

Universal Superabrasives
Precision Grinding Systems Div.
27588 Northline Road
Romulus MI 48174
Ph: 313-941-4420
Fax: 313-941-2948

Universal Technical Systems, Inc.
1220 Rock St.
Rockford IL 61101-1437
Ph: 815-963-2220
Fax: 815-968-8884
sales@uts.com
www.uts.com

User Solutions, Inc.
11009 Tillson Dr.
South Lyon MI 48178-9318
Ph: 248-486-1934
Fax: 248-486-6376
us@usersol.com
www.usersol.com

V
V & R Associates
P.O. Box 538
Wrightsville Beach NC 28480
Ph: 910-392-5559
Fax: 910-392-5559

Van Gerpen-Reece Eng.
1502 Grand Blvd.
Cedar Falls IA 50613

COMPANY INDEX

Ph: 319-277-7673
Fax: 319-277-4236

Von Ruden Mfg.
1008 First St. N.E.
Buffalo MN 55313-0699
Ph: 612-682-3122
Fax: 612-682-3954
norm@vonruden.com

W

W. E. Litwin Assoc.
235 Summer St.
Hingham MA 02043
Ph: 617-749-1323
Fax: 617-749-1340

WMW Machinery Company
44 W. High St.
West Nyack NY 10994
Ph: 914-358-3330
Fax: 914-358-2378

Walter Machine Co., Inc.
84-98 Cambridge Ave.
Jersey City NJ 07307
Ph: 201-656-5654
Fax: 201-656-0318

Wedin Intn'l. Inc.
1111 Sixth Ave.
Cadillac MI 49601
Ph: 616-779-8650
Fax: 616-779-8673

Welduction Corporation
24492 Indoplex Circle
Farmington Hills MI 48335
Ph: 248-442-0200
Fax: 248-442-9353
weldn@welduction.com
www.welduction.com

Wendt Dunnington
546 Enterprise Drive
Royersford PA 19468
Ph: 610-495-2850
Fax: 610-495-2865
wocim@aol.com

Wes-Tex Gear Inc.
11500 W. Highway 80E
Midland TX 79711-0605
Ph: 800-457-4327
Fax: 915-563-0934

West Industries Inc.
1700 Livingstone Road
Hudson WI 54016
Ph: 715-386-5867
Fax: 715-386-6473

Westech Gear Corp.
2600 E. Imperial Hwy.
Lynnwood CA 90262
Ph: 310-605-2600
Fax: 310-898-3590
d.kachel@ix.netcom.com

Westerman Companies
Alten Engineering Division
245 N. Broad St.
P.O. Box 125
Bremen OH 43107
Ph: 800-338-8265
614-569-4143
Fax: 614-569-4111

Western Spline Gage
728 E. Eighthstreet
P.O. Box 2277
Holland, MI 49423
Ph: 616-393-9580
Fax: 616-393-9583

Weyers Bros. (FT) Ltd.
Unit 1 Knight House
Lenthall Road

Loughton, Essex IG10 3UD
England
Ph: (44) 181-508-3886
Fax: (44) 181-508-7122

Windsor Gear Co.
110 Orchard Hill Drive
Windsor Locks CT 06096
Ph: 860-627-6347
Fax: 860-627-6347

Winsmith
172 Eaton Street
Springville NY 14141
Ph: 716-592-9311
Fax: 716-592-9546
winsmith@winsmith.com
www.winsmith.com

Winzeler Gear
7355 W. Wilson Ave.
Chicago IL 60656
Ph: 708-867-7971
Fax: 708-867-7974
johnwinzeler@msn.com
www.winzeler-gear.com

Wohlert Corp.
708 E. Grand River Ave.
Lansing MI 48906-5396
Ph: 517-485-3750
Fax: 517-485-0501
wohlim@aol.com

Worcester Gear Works
18 Grafton St.
P.O. Box 15026
Worcester MA 01615
Ph: 508-755-3109
Fax: 508-752-7759

Worrall Grinding Co.
1639 South Street
Anderson CA 96007
Ph: 916-365-4565
Fax: 916-365-9560
wgc@snowcrest.net
www.snowcrest.net/wgc/index.html

X

Xtek Inc.
11451 Reading Rd.
Cincinnati OH 45241
Ph: 513-733-7821
Fax: 513-733-7820

Z

ZF Industries Inc.
Industrial Drives Division
777 Hickory Hill Drive
Vernon Hills IL 60061
Ph: 847-634-3500 x305
Fax: 847-634-0780
industrial.drives@zf.com
www.zf.com

Zenith Sintered Products Inc.
N112 W18700 Mequon Road
P.O. Box 1009
Germantown WI 53022
Ph: 414-255-9050
Fax: 414-255-3306

Zero-Max, Inc.
13200 Sixth Avenue North
Minneapolis MN 55441
Ph: 612-546-4300
Fax: 612-546-8260
tleel@zero-max.com
www.zero-max.com

Zhuhai Intercontinental Pulleys Ltd.
43-101A Bailian Xincun Jida
Zhuhai, Guangdong 519015
China
Ph: (86) 756-3366825
Fax: (86) 756-3357936
zhzicui@pub.zhuhai.gd.cn

WORLD CLASS MANUFACTURER



Let us help you meet
tomorrow's challenges today:

- *Leading OE manufacturer of precision helical and spur gears.*
- *The team with experience and modern, flexible equipment.*
- *Committed to quality, cost, delivery, and customer service.*



GLOBAL GEAR

2500 Curtiss • P.O. Box 1406 Downers Grove, IL 60515

1-800-825-GEAR

CIRCLE 136

SPLINE GAGES MASTER GEARS



Designing and Building
Quality Gaging for the
Finest Manufacturers
in the World



WESTERN SPLINE GAGE

A DIVISION OF WESTERN/PEGASUS INC.
P.O. BOX 2277 HOLLAND, MI 49422
(616) 393-9580 FAX (616) 393-9583

Toll free (888) 455-GAGE

An ISO 9001 registered company

VARIABLE SPLINE GAGES

CIRCLE 158

SPIRAL BEVEL GEARS



Spiral & Straight Bevel Gear Manufacturing.
Commercial to aircraft quality gearing.
Spur, helical, splined shafts, internal & external,
shaved & ground gears. Spiral bevel grinding.

Mil-I-45208 • Mil-STD-45662, SPC

MIDWEST GEAR
& TOOL, INC.
26069 Groesbeck Hwy.
Warren, MI 48089



CONTACT:
CRAIG D. ROSS
(810) 776-7580
FAX (810) 776-2322

CIRCLE 113

\$\$\$\$\$\$

WHERE CAN I BUY ... ?

Looking for Gear Software
or Heat Treating Services?

Check out

GEAR TECHNOLOGY'S SPECIAL BUYERS GUIDES

Jan/Feb
• Gear Software

March/April
• Heat Treating Products • Services

\$\$\$\$\$\$

1997 Article Subject Index

ASYMMETRICAL GEARS

"Structural Analysis of Asymmetrical Teeth, Part II: Reduction of Size and Weight," DiFrancesco & Marini, Sept/Oct 1997, p. 47.

"Structural Analysis of Teeth with Asymmetrical Profiles-Part I," DiFrancesco & Marini, July/Aug 1997, p. 16.

BASICS

"The Basics of Shaving," Kosal, Nov/Dec 1997, p. 26.

"Determining a Hunting Mesh," Kish, May/June 1997, p. 18.

"The Geometry of Helical Mesh," Smith, Sept/Oct 1997, p. 53.

BOOK REVIEWS

"Gears and Gear Manufacture, the Fundamentals, by Richard H. Ewert," Wasilewski, May/June 1997, p. 9.

"Machinery's Handbook 25th Edition," Bartels, July/Aug 1997, p. 60.

BROACHING

"The Broaching of Gears," Kosal, March/April 1997, p. 48.

BUYERS GUIDES

"1998 Gear Industry Buyers Guide," Nov/Dec 1997, p. 33.

"Heat Treating Services Directory," March/April 1997, p. 28.

COATINGS

"Coated Gears in Enclosed Drive for Unique Water Vehicle," Stott, Jan/Feb 1997, p. 12.

"Composite Electroless Nickel Coatings for the Gear Industry," Feldstein & Feldstein, Jan/Feb 1997, p. 9.

"Hard Coatings on Contaminated Surfaces," Fischer, Jan/Feb 1997, p. 14.

"Improved Ion Bond Recoating for the Gear Industry," Pellman & Stevenson, Jan/Feb 1997, p. 17.

COMPUTERS

"Determining a Hunting Mesh," Kish, May/June 1997, p. 18.

"Gear Software You Didn't Know About," Stott, Jan/Feb 1997, p. 29.

"Meshing of a Spiral Bevel Gear Set With 3-D FE Analysis," Bibel & Handschuh, March/April 1997, p. 44.

"Structural Analysis of Asymmetrical Teeth, Part II: Reduction of Size and Weight," DiFrancesco & Marini, Sept/Oct 1997, p. 47.

"Structural Analysis of Teeth with Asymmetrical Profiles-Part I," DiFrancesco & Marini, July/Aug 1997, p. 16.

"The Way of the Web," March/April 1997, p. 57.

CRYOGENICS

"Increasing Hardness Through Cryogenics," Cesarone, March/April 1997, p. 22.

DESIGN

"Determining a Hunting Mesh," Kish, May/June 1997, p. 18.

"The Geometry of Helical Mesh," Smith, Sept/Oct 1997, p. 53.

"Meshing of a Spiral Bevel Gear Set With 3-D FE Analysis," Bibel & Handschuh, March/April 1997, p. 44.

"Shifting Gears-Exploiting the Potential for Plastics," Smith & Fletcher, Jan/Feb 1997, p. 35.

"Structural Analysis of Asymmetrical Teeth, Part II: Reduction of Size and Weight," DiFrancesco & Marini, Sept/Oct 1997, p. 47.

"Structural Analysis of Teeth with Asymmetrical Profiles-Part I," DiFrancesco & Marini, July/Aug 1997, p. 16.

ECONOMY

"Capitalizing on Your Human Capital," Bradley, Nov/Dec 1997, p. 11.

FAILURE

"Eddy Current Examination of Gear Systems," Collins, May/June 1997, p. 33.

"Gear Crack Propagation Investigations," Lewicki & Ballarini, Nov/Dec 1997, p. 18.

"Hard Coatings on Contaminated Surfaces," Fischer, Jan/Feb 1997, p. 14.

FAULT ANALYSIS

"Gear Crack Propagation Investigations," Lewicki & Ballarini, Nov/Dec 1997, p. 18.

FINISHING

"Basic Honing & Advanced Free-Form Honing," Wright & Schriefer, July/Aug 1997, p. 26.

GRINDING

"CNC Gear Grinding Methods," Richmond, May/June 1997, p. 43.
"Profile Grinding Gears from the Solid," Cluff, May/June 1997, p. 20.

GUEST EDITORIALS

"The Gear Standards Challenge," George, Sept/Oct 1997, p. 9.

HEAT TREATING

"Induction Heat Treating: Things Remembered, Things Forgotten," Specht, March/April 1997, p. 9.

"New Approaches to Nitriding," Wolf, March/April 1997, p. 63.

HELICAL GEARS

"CNC Gear Grinding Methods," Richmond, May/June 1997, p. 43.
"The Geometry of Helical Mesh," Smith, Sept/Oct 1997, p. 53.

HONING

"Basic Honing & Advanced Free-Form Honing," Wright & Schriefer, July/Aug 1997, p. 26.

INDUCTION HARDENING

"Induction Heat Treating: Things Remembered, Things Forgotten," Specht, March/April 1997, p. 9.

INSPECTION & MEASUREMENT

"Involute Inspection Methods and Interpretation of Inspection Results," Kotlyar, July/Aug 1997, p. 47.

"Obtaining Meaningful Surface Roughness Measurements on Gear Teeth," Lavoie, July/Aug 1997, p. 34.

"Thermal Effects on CMMs," Genest, Sept/Oct 1997, p. 41.

"Worm Gear Measurement," Barber, Sept/Oct 1997, p. 18.

INTERVIEWS

"A Conversation with Darle Dudley," Bartels, May/June 1997, p. 11.

"Eliot K. Buckingham: A Second-Generation Gear Master," Bartels, July/Aug 1997, p. 9.

"Joe Garfien: An American Success Story," Bartels, March/April 1997, p. 19.

MANAGEMENT

"Capitalizing on Your Human Capital," Bradley, Nov/Dec 1997, p. 11.

"Special Machine Manufacturer Brings Gear Making In-House," Mackowsky, Sept/Oct 1997, p. 25.

MANUFACTURING

"Basic Honing & Advanced Free-Form Honing," Wright & Schriefer, July/Aug 1997, p. 26.

"The Basics of Shaving," Kosal, Nov/Dec 1997, p. 26.

"The Broaching of Gears," Kosal, March/April 1997, p. 48.

"CNC Gear Grinding Methods," Richmond, May/June 1997, p. 43.

"Profile Grinding Gears from the Solid," Cluff, May/June 1997, p. 20.

"Special Machine Manufacturer Brings Gear Making In-House," Mackowsky, Sept/Oct 1997, p. 25.

MATHEMATICS

"Determining a Hunting Mesh," Kish, May/June 1997, p. 18.

"The Geometry of Helical Mesh," Smith, Sept/Oct 1997, p. 53.

MEASURING & TESTING

"Eddy Current Examination of Gear Systems," Collins, May/June 1997, p. 33.

"Involute Inspection Methods and Interpretation of Inspection Results," Kotlyar, July/Aug 1997, p. 47.

"Obtaining Meaningful Surface Roughness Measurements on Gear Teeth," Lavoie, July/Aug 1997, p. 34.

GREAT GEAR CORP.

Fine to coarse pitch; gear head and gear reducer.
Spur, helical, worm, bevel, and herringbone gears.
Plastic, sintering, nonferrous, steel and/or titanium alloy.
Skive and crown hobbing after heat treatment.
Shaving and grinding up to AGMA 14.

We can also supply shaper cutters (6-28 DP)
and hobs (2.5-32 DP) from Taiwan.

GREAT TAIWAN GEAR

115 Bendingwood Circle

Taylors, SC 29687

Tel: 864-322-1266 • Fax: 864-609-5268

E-mail: GreatTaiwanGear@worldnet.att.net

CIRCLE 195

SERVICE/QUALITY!**SPLINE GAGES**

We've been servicing customers for more than 30 years, with reliable **SERVICE** and **QUALITY**, because each gage is carefully produced to spec, with a traceable certificate if required.

We supply to ANSI specifications
British and DIN Standards, and
to those for French, Italian and
Japanese splines. We also supply
master gears. Call to discuss your
requirements with us.



PARKER INDUSTRIES INC.

1650 Sycamore Ave., Bohemia, NY 11716

1-516-567-1000 • Fax: 1-516-567-1355

CIRCLE 127

RESIZE • REFINISH • REBUILD

BRUSH PLATING AND ANODIZING

Coatings for
OEM and Repair

Stop-off
Break-in
Corrosion protection
Dimensional restoration



Copper
Silver
Tin
Nickel

Save time and money by keeping your parts in-house.
This portable, localized plating and anodizing process
can be used anywhere in your plant.

SIFCO SELECTIVE
PLATING
DIVISION OF SIFCO INDUSTRIAL, INC.

5708 Schaaf Road
Cleveland, OH 44131
Phone: (216) 524-0099
Fax: (216) 524-6331

<http://www.brushplating.com> Email: info@brushplating.com

CIRCLE 137

Now we show you what you can't see.

Clean

Despite coolant and contamination, a maintenance free totally enclosed chamber system ensures trouble free operation.

Pressure

A very high inner pressure stretches the steel concentrically, clamping the workpiece precisely and securely.

Wear Resistance

Special coatings are available up to 70 HRC which insure a long lifetime.

Precision

A TIR of $\le 0.0012''$ guarantees precise workpiece clamping for grinding, sharpening, turning, milling, inspection, balancing and fixturing.



Warranty

Standard SSD arbors are guaranteed for 1 year or 100,000 actuations.

SCHUNK
PRECISION WORKHOLDING SYSTEMS

Tel 919.572.2705 ■ Fax 919.572.2818
211 Kitty Hawk Drive ■ Morrisville, NC ■ 27560

Hydraulic Expansion Arbors

CIRCLE 153

1997 ARTICLE INDEX

"Thermal Effects on CMMs," Genest, Sept/Oct 1997, p. 41.
"Worm Gear Measurement," Barber, Sept/Oct 1997, p. 18.

METROLOGY

"M&M Precision, Penn State & NIST Team Up for Gear Metrology Research," July/Aug 1997, p. 39.

NITRIDING

"New Approaches to Nitriding," Wolf, March/April 1997, p. 63.

NONDESTRUCTIVE TESTING

"Eddy Current Examination of Gear Systems," Collins, May/June 1997, p. 33.

PLASTIC GEARS

"Hoechst Technical Polymers to Gather Plastic Gear Materials Data," July/Aug 1997, p. 38.

"Shifting Gears—Exploiting the Potential for Plastics," Smith & Fletcher, Jan/Feb 1997, p. 35.

PROFILES

"A Conversation with Darle Dudley," Bartels, May/June 1997, p. 11.

"Eliot K. Buckingham: A Second-Generation Gear Master," Bartels, July/Aug 1997, p. 9.

"Joe Garfien: An American Success Story," Bartels, March/April 1997, p. 19.

"Kate Gleason: The First Lady of Gearing," Bartels, Sept/Oct 1997, p. 11.

RESEARCH

"Hoechst Technical Polymers to Gather Plastic Gear Materials Data," July/Aug 1997, p. 38.

"Increasing Hardness Through Cryogenics," Cesarone, March/April 1997, p. 22.

"M&M Precision, Penn State & NIST Team Up for Gear Metrology Research," July/Aug 1997, p. 39.

SHAVING

"The Basics of Shaving," Kosal, Nov/Dec 1997, p. 26.

SOFTWARE

"Determining a Hunting Mesh," Kish, May/June 1997, p. 18.

"Gear Software You Didn't Know About," Stott, Jan/Feb 1997, p. 29.

"Meshing of a Spiral Bevel Gear Set With 3-D FE Analysis," Bibel & Handschuh, March/April 1997, p. 44.

"Structural Analysis of Asymmetrical Teeth: Reduction of Size and Weight," DiFrancesco & Marini, Sept/Oct 1997, p. 47.

"Structural Analysis of Teeth with Asymmetrical Profiles—Part I," DiFrancesco & Marini, July/Aug 1997, p. 16.

SPIRAL BEVEL GEARS

"Meshing of a Spiral Bevel Gear Set With 3-D FE Analysis," Bibel & Handschuh, March/April 1997, p. 44.

SPUR GEARS

"CNC Gear Grinding Methods," Richmond, May/June 1997, p. 43.

STANDARDS

"The Gear Standards Challenge," George, Sept/Oct 1997, p. 9.

WEAR

"Eddy Current Examination of Gear Systems," Collins, May/June 1997, p. 33.

WORM GEARS

"Worm Gear Measurement," Barber, Sept/Oct 1997, p. 18.

A complete index of *Gear Technology* articles is available online at <http://www.geartechnology.com>.

Call 847-437-6604 for info about complete back issues & copies of single articles.

Now you can turn your surface grinder into a spur gear and spline grinder.

Normac's revolutionary spur gear and spline grinding package retrofits to your current surface grinder turning it into a profit making center at a fraction of the cost of a gear grinding machine.

The package includes:

- A.** Formaster CNC Grinding Wheel Profiler with super precision lead screws.
 - B.** Lehmann CNC indexing head with ± 2 arc seconds of positioning accuracy.
 - C.** Slide with tailstock
- Also included:** Custom gear profile generating software and a Siemens 810M controller.
- Optional:** Adjustable sine bar type slide with tailstock.

Call or E-mail today for further information



Normac, Inc.
Precision Grinding Machines

PO Box 245 / 720 E Baseline Road / Northville, MI 48167 USA
Tel: +1.248.349.2644 / Fax: +1.248.349.1440
E-mail: info@normac.com / Web: http://normac.com

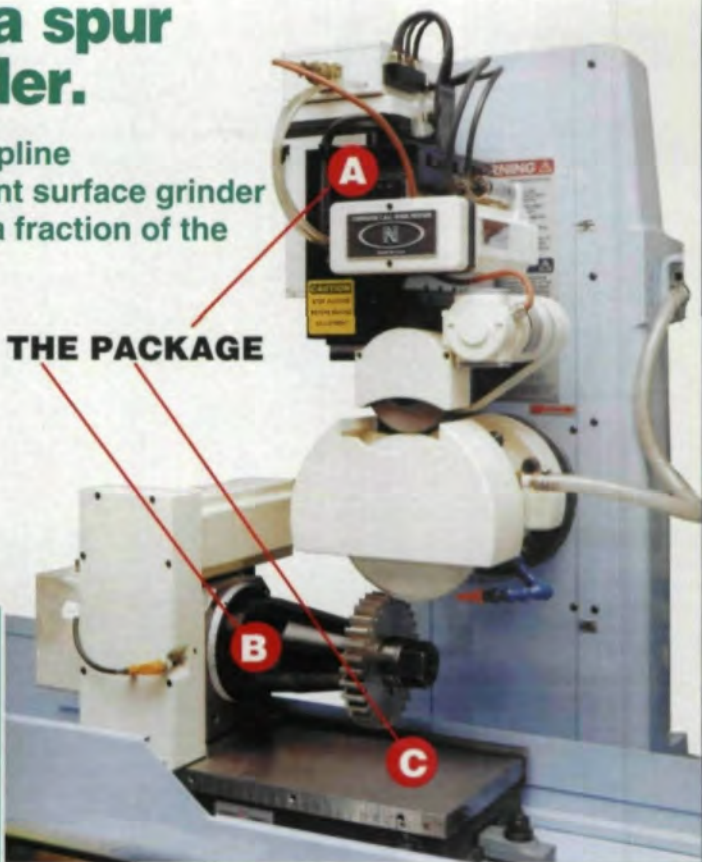

CIRCLE 141

Saikuni

Ataka Group • Ataka Machinery Co., Ltd. • Ataka Engineering Co., Ltd.
Phone (81)-52-772-0690 • Fax (81)-52-772-0692
e-mail: ataka@mx.meshnet.or.jp



Rack Milling Machine NR-8LL

3-Axis CNC Controlled Machine

- This machine can cut the works under large stock removal and large feeds with automatic cutting cycle by pre-setting the cutting data.

SEE BOTH MACHINES AT GEAR EXPO '97 (DETROIT)



Spiral Cutter Sharpening Machine NCG-125/205

Advanced, Fully Automatic, Multi-Purpose, 5-Axis CNC Grinding Machine

- Full automatic cycle with automatic cutter positioning device
- Power clamping for easy load/unload
- Easy setup minimizes downtime
- Also sharpens coniflex, helical pinion and revacycle cutters

CIRCLE 148



TRU-VOLUTE®

the first name in gear generating tools

All TRU-VOLUTE gear generating tools are precision ground to the highest accuracy. If proven reliability and consistent accuracy are important to you, then **request TRU-VOLUTE** tools for your next job.

- Proven Durability
- Extensive Stock — All Bore Sizes
- 12 DP and finer
- Available in HSS M42 and Solid Carbide
- TiN and TiCN Coatings
- Introducing Express Delivery and TRU-VOLUTE Class AAA ultimate accuracy tolerances.

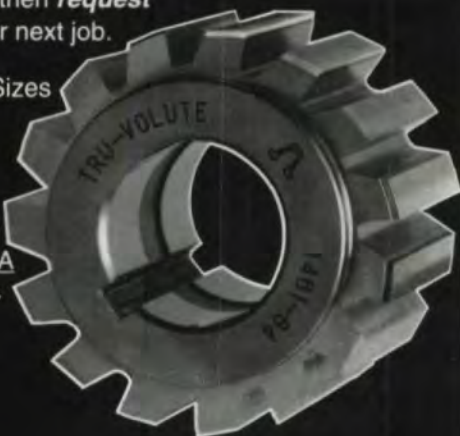

**RUSSELL,
HOLBROOK
& HENDERSON, INC.**

Phone: 201-670-4220 • Fax: 201-670-4266
2 North Street, Waldwick, New Jersey 07463

CIRCLE 134



LeCOUNT EXPANDING MANDRELS

**WANTED?
MORE ACCURACY
MORE EXPANSION
MORE VERSATILITY
LONGER LIFE
AND LESS COST?**



THE ANSWER FOR 150 YEARS.

LeCOUNT, Inc.

12 Dewitt Dr. • PO Box 950 • White River Jct., VT 05001 U.S.A.

Tel: (800) 642-6713 or (802) 296-2200 • Fax: (802) 296-6843 E-mail: lecount@sover.net

Website: <http://www.sover.net/~lecount/> (includes product specifications)

CIRCLE 112

ADVERTISER INDEX

For more information about a product or service advertised in this issue of *Gear Technology*, circle the appropriate number on the Reader Response Card and put the card in the mail.

Advertiser	Reader Service #	Page #
Ajax Magnethermic	118, 117	43, 61
Allied Gear	101	71
Amarillo Gear	107	51
American Metal Treating	174	70
America Pfauter, L.P.	100, 183	IFC-1, 37
American Wera	197	4
ATA Gears	119	37
Ataka Engineering	148	67
A/W Systems	105	44
Barit International	175, 186	15, 45
Basic Incorporated Group	111	17
Chamfermatic	171	12
Crown Gear B.V.	167	14
Diamonex	144, 194	9, 53
D.I.G.I.T.	157	31
Dr. Kaiser (S. L. Munson)	103	10
Dyer Co.	120	47
Emuge	130	35
Engineered Heat Treat, Inc.	123	37
Euro Tech	147	12
Fässler	135	8
Fellows Corporation	125	51
Giddings & Lewis	126	14
The Gleason Works	100, 129	IFC-1, 40
Global Gear	136	63
Great Gear Corp.	195	65
Holroyd	121, 179	32, 51
Ikegai America	124	28
ITW Heartland	110	21
JRM International	131, 143	15, 53
Kapp Tech	165, 145	43, IBC
Koepfer America	116	4
Koro Sharpening Service	176	45
LeCount	112	68
LMT-Fatte	104, 159	29, 40
M & M Precision Systems	140, 163	38-39, 53
Mahr Corp.	122	48
Midwest Gear Corp.	138	71
Midwest Gear & Tool	113	64
Mitsubishi	109	55
Moore Products	106, 162	5, 43
National Broach	114, 160	6, 45
Niagara Gear	151	71
Normac	141	67
Ontario Drive & Gear Ltd.	142	47
Parker Industries	168, 127	27, 65
PC Engineering	178	70
Perry Technology	146, 181	27, 43
Pfauter-Maag Cutting Tools, LP	183, 177, 102	37, 71, OBC
Presrite	108, 187	41, 45
Profile Engineering	133	47
Pro-Gear	180	71
The Purdy Corporation	150	31
Radyne	152, 139	40, 57
Russell, Holbrook & Henderson	134	68
Schunk, Inc.	153	66
Shin-Shin Enterprise Corp.	172	69
Sifco Plating	137	66
Starcut Sales	128, 132, 182, 188	2, 16, 51, 71
Stock Drive Products/ Sterling Instrument	198	25
Surface Combustion	115, 199	13, 53
Sytec Corp.	149	40
United Tool Supply	155	69
Van Gerpen-Reece Engineering	154	47
Western Spline Gage	158	63

Unite-A-Matic™

TRUE DIMENSION GEAR INSPECTION



Provides actual over ball/pin measurement of any helical or spur gear or spline without the need of costly setting masters.

Provides vital S.P.C. information.

CAPACITY:

9" O.D.

8" I.D.

Gage Division

United Tool Supply

851 OHIO PIKE • CINCINNATI, OHIO 45245 • (513) 752-6000 • FAX (513) 752-5599

CIRCLE 155

ShinShin Enterprise Corp. The Best Solution for Your Gear Demands

For over 25 years ShinShin's experience and technology in manufacturing GEARS have acquired a worldwide reputation for reliable quality and reasonable price.



Range of Products

- Splines
- Pump Gears
- Rack & Pinion
- Helical Gears
- Worm & Worm Gear Sets
- Bevel & Miter Gear Sets
- External/Internal Spur Gear



Material

- Steel
- Iron
- Plastic
- Copper
- Bronze
- Stainless Steel
- Cast
- Nylon
- Carbon
- Brass
- Aluminum
- And More

Capacity

- MAX. O.D. : 1500mm
- MAX. Module: 20 (DP 1.27)
- MAX. Length: 3000mm
- MAX. Helical angle: 45°

Manufacturers today face increasing demands from their customers regarding quality, delivery and price ... ShinShin GEARS meet those demands.

**WE ARE AN ISO 9002
REGISTERED COMPANY**

ShinShin Enterprise Corp
37 DA YO 5th Street • TAICHUNG 407 • TAIWAN R.O.C.
Tel: 886-4-3239266 • Fax: 886-4-3229951
E-mail: shin02@ms3.hinet.net • <http://www.shintech.com>

Our USA Agent
ShinShin Enterprise Corp
65 Earle Avenue • Lynbrook, NY 11563
Phone: 516-593-1135 • Fax: 516-887-1292

Shin Shin Enterprise Co. Ltd., (China)
No. 41320 Nan-Chou Nan-Hsien,
Hunan, PRC
Tel: 86-737-522-3446 • Fax: 86-737-522-2761

CIRCLE 172

CLASSIFIEDS

HELP WANTED

REQUIRE SALES REPRESENTATIVE FOR GEAR CUTTING TOOLS

We are an Indo-Italian joint venture company manufacturing various gear cutting tools such as:

- Cutting Blades for Straight & Spiral Bevel Gears (Gleason Type)
- Gear Shaper Cutters
- Gear Shaving Cutters
- Spline Milling Cutters
- Master Gears

The company supplies its products to leading Indian & overseas gear manufacturers. We are looking for a result-oriented sales rep to develop business for our products in U.S.A.

Interested persons/companies should apply with complete details of their present operations & setup.

GAJRA EXPORTS
3/1 Race Course Rd.
Indore 452 003 M.P., India
Ph: 01191731433011 • Fax:01191731432909

Canadian gear manufacturer in business since 1968 is looking for a professional sales agent or rep. to develop the eastern U.S. market.

We are looking for people with sales experience in machining and gear cutting.

- Please apply in writing by mail or by fax.
- C.V. resume if individual.
- Include brochures and relevant info if company.

Sherbrooke Gear Works
1190 Galt Est.
Sherbrooke, Quebec J1G 1Y5
Canada

Att: Patrick Veilleux
819-566-1040 tel
819-566-7674 fax

JOIN A WINNING TEAM WHERE PEOPLE ARE SHAPING TOMORROW!

SUNDSTRAND AEROSPACE IS A LEADING SUPPLIER OF TECHNOLOGY BASED AEROSPACE COMPONENTS AND SYSTEMS. LET THE ROCKY MOUNTAINS BE YOUR BACK YARD WHEN YOU BECOME PART OF SUNDSTRAND IN OUR SELF DIRECTED WORK TEAM ENVIRONMENT IN DENVER, COLORADO.

- GEAR GRINDER AND HOBBER
 - GEAR SHAPING AND HOBGING
 - REISCHAUER AND KAPP GEAR GRINDING
 - BROACHING
- Minimum 3 years experience required.

EXCELLENT BENEFITS PACKAGE INCLUDING HEALTH AND LIFE INSURANCE, VACATION, 401K WITH COMPANY MATCH, HOLIDAYS, PENSION AND 100 PERCENT EDUCATIONAL REIMBURSEMENT.

Interested candidates can obtain an application which must be completed with detailed salary history by December 31, 1997 to:



SUNDSTRAND
AEROSPACE

2480 WEST 70TH AVENUE, DENVER, CO 80221
Out of state inquiries call our main Guard Office at 303-426-2800 for application. An Affirmative Action/Equal Opportunity Employer

COMPUTER AIDS

GRAPHICAL GEAR DESIGN

- Generated Gears
- Tools and Tool Paths
- Non-Generated Gears
- Involute Splines, Racks
- Inspection Calculations
- Animated Meshing
- Form Calculations
- .DXF File Output



**GearShop for
Windows™**

Because you asked for it!
800-437-2368

CIRCLE 178

HEAT TREATING

Contour Induction Hardening Specialists

Spur, helical and bevel gears

Our gear hardening equipment includes 3 NATCO submerged process machines and 4 AJAX CNC-controlled gear scanning machines. We can tool to meet any production need. Call for a company brochure.

American Metal Treating Company
1043 East 62nd Street
Cleveland, OH 44103
(216) 431-4492
Fax: (216) 431-1508

CIRCLE 174

WE'RE HIRING

- Gear Machine Repairman** — Experienced troubleshooter for mechanical and hydraulic repairs. Knowledge of electrical systems desirable. No travel.
- Sales Coordinator/Associate Trainee** — We need an ambitious self-starter with some familiarity with gear machines, their tooling and accessories to fill this job. Plenty of room for advancement.

Friendly work environment at our convenient northwest suburban Chicago location. Profit sharing, health insurance.



Cadillac Machinery Co. Inc.
1401 Lunt Avenue
Elk Grove, IL 60007

Fax your resume to 847-437-6618.

Rates—Line Classified: \$35 per line, 8 lines per inch, \$270 minimum. Classified Display (3" min.): 1X—\$620, 3X—\$575, 6X—\$545. Additional per inch: 1X—\$210, 3X—\$200, 6X—\$190. *Gear Technology* will set type to advertiser's layout or design a classified ad at no extra charge. **Payment:** Full payment must accompany classified ads. Send check or Visa/MasterCard/American Express number and expiration date to *Gear Technology*, P.O. Box 1426, Elk Grove Village, IL 60009. **Agency Commission:** No agency commission on classified ads. **Materials Deadline:** Ads must be received by the 20th of the month, two months prior to publication. **Acceptance:** Publisher reserves the right to accept or reject classified advertisements at his discretion.

**TO ADVERTISE
IN THE CLASSIFIED
SECTION
CALL 847-437-6604**

SERVICES

HOB SHARPENING SERVICE

Star Cutter is celebrating its 70th anniversary, 1927-1997



West Branch Industries
Subsidiary of Star Cutter Co.
2083 W. M-55, West Branch, MI 48661
1-888-Resharp • 1-888-737-4277

Phone: (517) 345-2865 • FAX: (517) 345-5660

CIRCLE 188

PFAUTER-MAAG CUTTING TOOLS LIMITED PARTNERSHIP

PICK UP AND DELIVERY IN MANY AREAS

- HOB SHARPENING
- SHAVING CUTTER GRINDING
- TIN, TiCN, & TiAlN COATING SERVICES
- CUSTOM HEAT TREAT SERVICE

PFAUTER-MAAG CUTTING TOOLS
1351 Windsor Road, P.O. Box 2950
Loves Park, IL 61132-2950
Phone (815) 877-8900
Fax (815) 877-0264

CIRCLE 177

THE TRADE TOOLS OF YOUR TRADE

powertransmission.com
THE POWER TRANSMISSION HOME PAGE

geartechnology.com
THE GEAR INDUSTRY HOME PAGE

GEAR TECHNOLOGY
The Journal of Gear Manufacturing

A WORLD OF INFORMATION

GROUND GEARS

- Precision Ground Spur, Helical and Pump Gears to AGMA Class 15
- The latest grinding technology including:
 - Reishauer RZ300E Electronic Gear Grinders
 - Gleason TAG 400 CNC High Production Gear Grinder
 - Cincinnati Milacron CNC Cylindrical Grinder
- Continuous Process Improvement Utilizing SPC and Quality Planning
- JIT Delivery using Innovative Stocking Programs

800-447-2392
Fax: 716-874-9003



CIRCLE 151

GEAR TOOTH GRINDING

- Spur • Helical
- Herringbone (with groove)
- Capacity up to 63" O.D., 1 D.P., 16" face

AGMA Certification Inspection

Delivery to Meet Your Requirements

Midwest Gear Corp.
2182 E. Aurora Rd.
Twinsburg, OH 44087
Phone 216-425-4419
Fax 216-425-8600

Direct your inquiries to
Ron Humphrey, General Manager

CIRCLE 138

ALLIED GEAR COMPANY

*Manufacturers of
Cut Tooth Gears and Sprockets*

- Spur and helical gears to 80" O.D. and 1 1/4 DP.
- Bevel gears to 36" O.D. and 1 1/2 DP.
- Internal gears to 36" P.D. and 3 DP.
- Worm gears to 48" O.D. and 2 DP.
- Sprockets to 80" O.D. and 2 1/2" pitch.
- Spline shafts to 120" long.
- Crown shaving to 24" O.D.
- Gear tooth grinding to 24" O.D. and 2 D.P.
- Thread grinding to 14" O.D. and 40" long.
- Internal and external cylindrical grinding.

Call for our brochure

Phone 773-287-8742 • Fax 773-287-4720

CIRCLE 101

GEAR TOOTH GRINDING SERVICES

- Cost effective gear tooth grinding specialists
- Gear manufacturers are our only customers
- Prototype and production quantities
- Capacity to 27.5" P.D., 3.5 D. P.
- Able to match delivery to your requirements
- All service to AGMA standards with Certified Gear Inspection Equipment

PRO-GEAR COMPANY, INC.

23 Dick Road Depew, NY 14043
Phone (716) 684-3811
Fax (716) 684-7717

CIRCLE 180

U.S. POSTAL SERVICE STATEMENT OF OWNERSHIP, MANAGEMENT & CIRCULATION AS OF SEPTEMBER 29, 1996

Publication: Gear Technology, the Journal of Gear Manufacturing	Nature & Extent of Circulation	No. of Copies of Single Issue Published Nearest to Filing Date
ISSN No.: 0743-6858	Average No. of Copies Each Issue During Preceding 12 Months	
Published: Bimonthly, 6 issues per year	Total No. Copies	13,925
Annual Subscription Price: \$45.00	Paid and/or Requested Circulation (not mailed)	8
Mailing Address of Publication: 1425 Lunt Ave., Elk Grove Village, Cook County, IL 60007	Paid and/or Requested Circulation (mailed)	9,266
Name & Mailing Address of Publisher: Michael Goldstein, 1425 Lunt Ave., Elk Grove Village, Cook County, IL 60007	Total Paid and/or Requested Circulation	9,274
Name & Mailing Address of Editor: Michael Goldstein, 1425 Lunt Ave., Elk Grove Village, Cook County, IL 60007	Free Distribution by Mail	3,490
Name & Mailing Address of Managing Editor: Michael Goldstein, 1425 Lunt Ave., Elk Grove Village, Cook County, IL 60007	Free Distribution Outside the Mail (Carriers or Other Means)	605
Name & Mailing Address of Owner: Michael Goldstein & Richard Goldstein, 1425 Lunt Ave., Elk Grove Village, Cook County, IL 60007	Total Free Distribution	4,095
Known Bondholders: None	Total Distribution	13,369
	Copies Not Distributed	556
	Total	13,925
	Percent Paid and/or Requested Circulation	69.4%
		53.2%

Guide for Gear Giving

Gear Technology's bimonthly aberration — gear trivia, humor, weirdness and oddments for the edification and amusement of our readers. Contributions are welcome.

The Addendum team hates to admit it, but we're coming up hard on the holiday season again, and that means straining the old brain cells to come up with a good gift list. Once you've taken Aunt Maude's fruit cake brick out of the freezer to recycle it to the least-favorite person on your list, things start to get tricky. Then there's the concern that you're going to end up getting yet another ugly sweater, body-of-steel home exercise gadget (special TV offer; three payments of \$29.95; no CODs, please) or commemorative Elvis plate.

But never fear. As a public service, the Addendum Shopping Team has been scouring the landscape for the season's "must-have" items for gear giving and receiving. Put these items on your list, or circle your favorites and leave the column where your own personal Santa will find it.

For the serious-minded among you (and who's not serious about gears, besides the Addendum Team, that is?), there's the *Maag Gear Book*. This staple of the gear engineering library is in print and available from Global Engineering Documents for \$95.00. (Call 800-854-7179.) If that's not serious enough for you, remember that major technical

societies like AGMA, SME and ASM have big catalogs of all sorts of engineering books, CD-ROMs and software. ASM is offering four volumes of its massive metals *Handbook*® on CD for \$443.00. The entire twenty volumes will be available by December of next year.

For a bit less strenuous reading, our book review editor recommends a little gem called *Longitude* by Dava Sobel (Walker & Company, New York). This is the true story of John Harrison, the self-taught carpenter, clock-maker, mechanic and engineer who solved the problem of calculating longitude, one that had stumped such luminaries as Galileo, Edmund Halley, Christiaan Huygens and Robert Hooke. The crux of the problem is that to calculate longitude, you need to be able to tell time precisely in two places at once, no mean feat in a time before electronic communications and satellites. The story is not just one of engineering ingenuity, but politics, professional jealousy, idealism, class struggle and lots of money.

If your tastes run to the more unusual (like the Addendum staff's), you will want to check out the catalog from American Science & Surplus (847-982-0870 or www.sciplus.com). Here you can order everything from a tabletop-sized dry pellet steam plant to a "talking duck faucet," which apparently is just what it sounds like, an animal-shaped plastic spout to be attached to your regular faucet to make "more or less appropriate" animal sounds when the water flows through. Other must-have items include neon-colored sand paper, make-your-own slime & ooze kits, small motors and gearboxes, French Foreign Legion uniform buttons, army-green "pocket spittoons" and your very own Archimedes pump (for pumping up dead Greek scientists?). Many items are sold in quantity and are remarkably



inexpensive. Lots of good educational kits and toys for your budding engineers, plus odd, but useful, office and lab supplies. This place could solve your stocking stuffer problems.

What would the holidays be without toys? And what's the point of buying stuff for the kids you wouldn't want to play with? For example, Hasbro is relaunching a few of the original Tonka trucks in its Classic Edition series. The 1949 Dump Truck and the 1956 Pickup are back in real metal with real heft, just right for dropping on Grandma's foot, floor-and-furniture scratching and other fun stuff. Then there's the Mercury Astronaut doll, 12" high, complete with spacesuit, helmet, gloves and dog tags. The astronaut's compatriots include a Tuskegee Fighter Pilot, General Patton and, for your own G.I. Jane, the U.S. Army Helicopter Pilot, who just happens to be a girl.

Finally, our staff doesn't want to make your shopping any harder than it has to be. Just send us money. One size fits all, and the color's always right. ☉

The Addendometer: If you've read this far on the page and enjoyed it, please circle 225.



Now Under One Roof in Colorado

KAPP

NILES BERLIN

Machine Tools and Process Solutions for Form Grinding of Gears and Special Profiles up to 4,000 mm (13 ft.) in Diameter



For Grinding of

- External and Internal
Spur and Helical Gears
Gerotor Profiles
- Compressor Rotors
- Vane Pump Rotors
- Rotary Pistons
- Pump Spindles
- Ball Screw Tracks, Worms
- Linear Ball Tracks
- Special Requests

KAPP TECH

KAPP CBN Grinding Wheels



Industries Served

- Automotive
- Commercial Vehicles
- Utility Vehicles
- Railway
- Aircraft & Aerospace
- Ship Building
- Industrial Equipment
- Energy Generation
- Heavy Duty Machinery
- Mining & Construction

KAPP Sales & Service L.P.

2870 Wilderness Place Boulder, Colorado USA Phone (303) 938-9737 FAX (303) 447-1131

Pfauter-Maag Cutting Tools. Where the world goes for quality.

Manufacturers everywhere need new cutting tool technology that can produce parts faster, more accurately and less expensively than ever before. That's why more companies worldwide turn to Pfauter-Maag Cutting Tools.

At Pfauter-Maag Cutting Tools, we have people and plant resources unavailable

anywhere else in the world. We can find the absolute best tooling approach for your application and help put it to use more productively than you might have believed possible.

So turn to Pfauter-Maag Cutting Tools for the best in gear hobs, shaper cutters, shaving cutters, form-relieved milling cutters and CBN grinding wheels.

Pfauter-Maag Cutting Tools

A Gleason Company

Telephone (815) 877-8900 • Fax (815) 877-0264
1351 Windsor Road, P.O. Box 2950, Loves Park, IL 61132-2950
Web Site: <http://www.pmct.com> • E-Mail: Sales@pmct.com

