

# Effect of Shot Peening on Surface Fatigue Life of Carburized and Hardened AISI 9310 Spur Gears

by

Dennis P. Townsend and Erwin V. Zaretsky  
NASA Lewis Research Center  
Cleveland, Ohio

## Summary

Gear surface fatigue endurance tests were conducted on two groups of 10 gears each of carburized and hardened AISI 9310 spur gears manufactured from the same heat of material. Both groups were manufactured with standard ground tooth surfaces. The second group was subjected to an additional shot-peening process on the gear tooth surfaces and root radius to produce a residual surface compressive stress. The gear pitch diameter was 8.89 cm (3.5 in.). Test conditions were a gear temperature of 350 K (170°F), a maximum Hertz stress of  $1.71 \times 10^9$  N/m<sup>2</sup> (248 000 psi), and a speed of 10 000 rpm.

The shot-peened gears exhibited pit-

ting fatigue lives 1.6 times the life of the standard gears without shot peening. Residual stress measurements and analysis indicate that the longer fatigue life is the result of the higher compressive stress produced by the shot peening. The life for the shot-peened gear was calculated to be 1.5 times that for the plain gear by using the measured residual stress difference for the standard and shot-peened gears. The measured residual stress for the shot-peened gears was much higher than that for the standard gears.

## Introduction

Shot peening has long been used as a method for improving the bending strength of gear teeth.<sup>(1-3)</sup> However, shot peening has not been considered as a

means of extending the surface fatigue life of gears. In essence, shot peening induces a residual compressive stress below the surface of the gear tooth. Studies of residual stresses in rolling-element bearings have shown that increased residual compressive stress will increase rolling-element (surface) fatigue life.<sup>(4-5)</sup> There is always a need to improve the surface fatigue life of aircraft gears, especially in helicopter and V/STOL aircraft.

The objectives of the research reported herein were (1) to investigate the effects of shot peening of gear teeth on the surface fatigue life of standard ground, case-carburized, and hardened AISI 9310 spur gears, (2) to compare the life of shot-peened gears to that of non-shot-peened gears manufactured with the same material and specifications, and (3) to determine the residual stress produced by shot peening and its effect on the surface fatigue life.

To accomplish these objectives, 20 spur gears were manufactured from a consumable-electrode-vacuum-melted single heat of AISI 9310 material. Ten of these gears were shot peened after finish grinding. The gear pitch diameter was 8.89 cm (3.5 in.). Both the shot-peened and non-shot-peened gears were then tested to fatigue by surface pitting under identical test conditions. These test conditions included a gear temperature of 350 K (170°F), a maximum Hertz stress of  $1.71 \times 10^9$  N/m<sup>2</sup> (248 000 psi), and a speed of 10 000 rpm.

## Apparatus, Specimens, and Procedure Gear Test Apparatus

The gear fatigue tests were performed

## AUTHORS:

**DR. ERWIN V. ZARETSKY** has been a member of the research staff of the NASA Lewis Research Center since 1957 where he is Chief Engineer for Structures. He was head of the NASA Bearing, Gearing and Transmission Section and was manager of the NASA Helicopter Transmission System Technology Program. Zaretsky is author or co-author of over 125 technical papers, books, and articles in the field of bearings, gears and lubrication technology. He is a Licensed Professional Engineer in Ohio and has been admitted to the Bars of Ohio and Illinois as well as the Federal Bar. Zaretsky has chaired several national committees for the ASME and was a Director of the Cleveland Society of Professional Engineers and is a former Chairman of the Cleveland Section of ASME. The Lubrication Division of the ASME honored him in 1972, by bestowing upon him their Distinguished Service Award. In 1979, he was further

honored by the ASME when he was made Fellow of the Society. Dr. Zaretsky has a BSME from the Illinois Institute of Technology and a Doctor of Law Degree from Cleveland State University.

**MR. DENNIS P. TOWNSEND** is the Manager of the Gear Research Program for Advanced Aircraft Applications at the NASA Lewis Research center. He directs and conducts research on gear lubrication, gear materials, and gear design. He has authored or co-authored over 54 NASA technical society publications. Townsend holds a BS in Mechanical Engineering from the University of West VA. He served with the ASME Design Division as Chairman of the Power Transmission and Gearing Committee from 1978 to 1983, and he was Papers Review Chairman and Associate Editor of the journal for two years. He is now a member of the ASME Design Engineering Division Executive Committee.

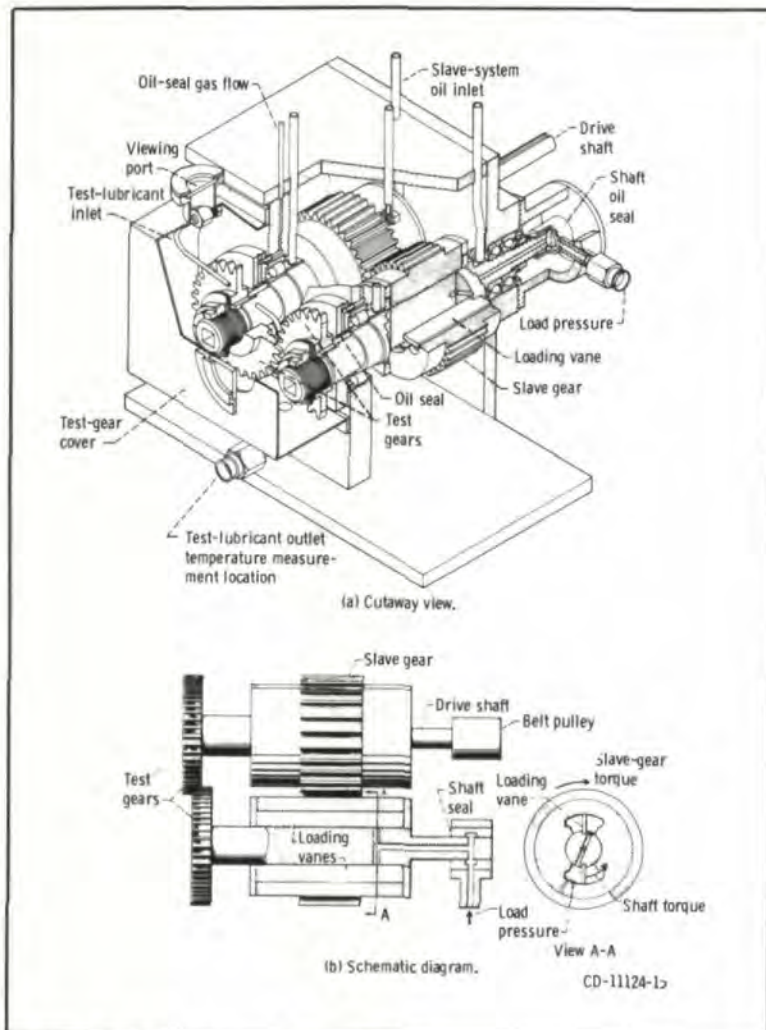

Fig. 1—NASA Lewis Research Center's gear fatigue test apparatus.

in the NASA Lewis Research Center's gear test apparatus (Fig. 1). This test rig uses the four-square principle of applying the test gear load, so that the input drive only needs to overcome the frictional losses in the system.

A schematic of the test rig is shown in Fig. 1(b). Oil pressure and leakage flow are supplied to the load vanes through a shaft seal. As the oil pressure is increased on the load vanes inside the slave gear, torque is applied to the shaft. This torque is transmitted through the test gears back to the slave gear, where an equal, but opposite torque is maintained by the oil pressure. This torque on the test gears, which depends on the hydraulic pressure applied to the load vanes, loads the gear teeth to the desired stress level. The two identical test gears can be started under no load, and the load can be applied gradually, without changing the running track on the gear teeth.

Separate lubrication systems are pro-

vided for the test gears and the main gearbox. The two lubrication systems are separated at the gearbox shafts by pressurized labyrinth seals. Nitrogen is the seal gas. The test gear lubricant is filtered through a 5- $\mu$ m-nominal fiberglass filter. The test lubricant can be heated electrically with an immersion heater. The temperature of the heater skin is controlled to prevent overheating the test lubricant.

A vibration transducer mounted on the gearbox is used to automatically shut off the test rig when a gear surface fatigue occurs. The gearbox is also automatically shut off if there is a loss of oil flow to either the main gearbox or the test gears, if the test gear oil overheats, or if there is a loss of seal gas pressurization.

The belt-driven test rig can be operated at several fixed speeds by changing pulleys. The operating speed for the tests reported herein was 10 000 rpm.

#### Test Materials

The test gears were manufactured

TABLE I.  
SHOT-PEENING  
SPECIFICATION

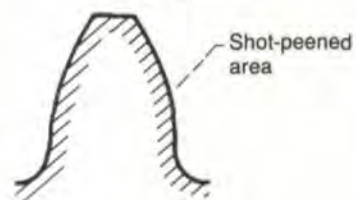

|   |                                  |
|---|----------------------------------|
| Specification                                       | MIL-S-131658<br>BPS FW 4409      |
| Shot size   | .070                             |
| Shot type   | Cast steel                       |
| Intensity (height of Almen strip, type A), mm (in.) | 0.18 to 0.23<br>(0.007 to 0.009) |
| Coverage (sides and root only), percent             | .200                             |

TABLE II.  
NOMINAL CHEMICAL  
COMPOSITION OF CVM AISI  
9310 GEAR MATERIAL

| Element | Composition, wt% |
|---------|------------------|
| C       | 0.10             |
| Mn      | .63              |
| Si      | .27              |
| Ni      | 3.22             |
| Cr      | 1.21             |
| Mo      | .12              |
| Cu      | .13              |
| P       | .005             |
| S       | .005             |

from consumable-electrode-vacuum-melted (CVM) AISI 9310 steel from the same heat of material. Both sets of gears were case hardened to a case hardness of Rockwell C58 and a case depth of 0.97 mm (0.038 in.). The nominal core hardness was Rockwell C40. One set of the gears was shot peened, after finish grinding, on the tooth root and the tooth profile according to the specifications given in Table I. The chemical composition of the material is given in Table II. Both sets of gears were case carburized and heat treated in accordance with the heat treat-

Fig. 2—Photomicrographs of case and core for standard and shot-peened spur gears.

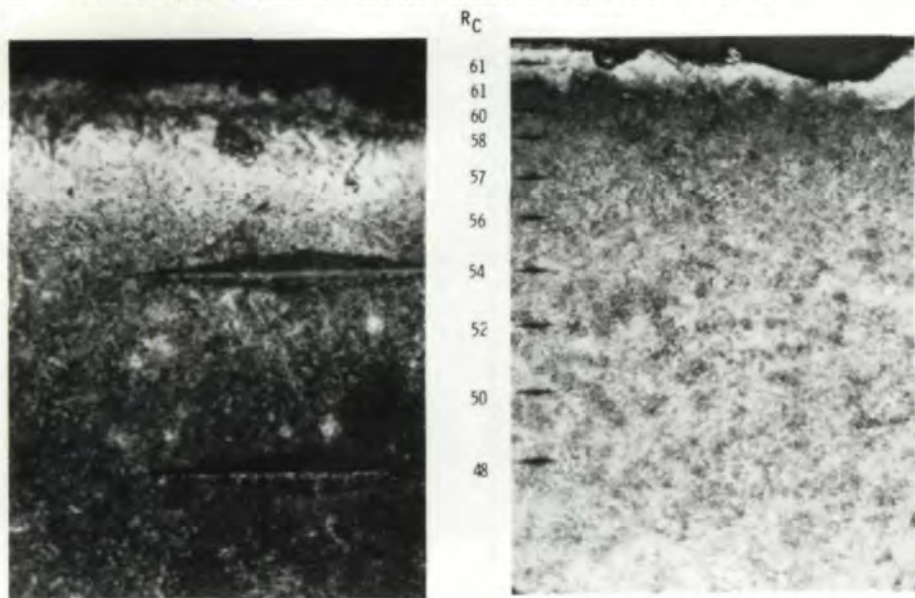

(a) Standard gear case.

(b) Standard gear core.

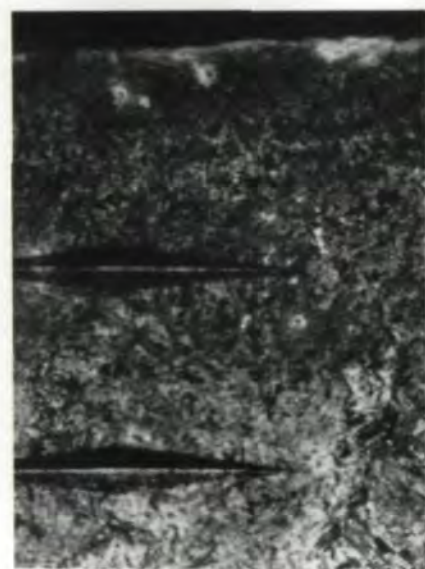

(c) Shot-peened gear case.

(d) Shot-peened gear core.

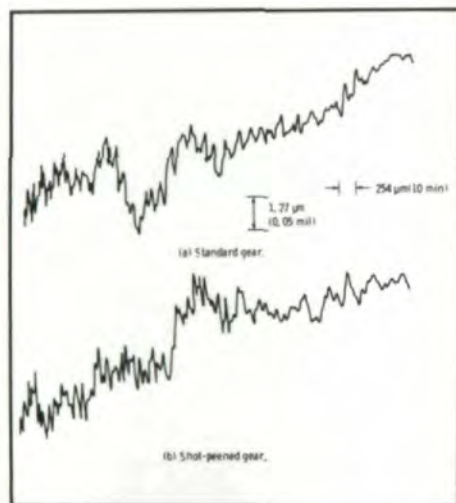

Fig. 3—Surface finish of standard ground and shot-peened gears.

ment schedule of Table III. Fig. 2 is a photomicrograph of an etched and polished gear tooth surface showing the case microstructure of the AISI 9310 material.

### Test Gears

Dimensions of the test gears are given in Table IV. All gears have a nominal surface finish on the tooth face of  $0.406 \mu\text{m}$  ( $16 \mu\text{in.}$ ) rms and a standard  $20^\circ$  involute profile with tip relief. Tip relief was  $0.0013 \text{ cm}$  ( $0.0005 \text{ in.}$ ), starting at the highest point of single-tooth contact. Surface traces of the standard gear and the shot-peened gear are shown in Fig. 3.

### Test Lubricant

All gears were lubricated with a single

TABLE III. - HEAT TREATMENT FOR AISI 9310

| Step | Process                      | Temperature |      | Time, hr |
|------|------------------------------|-------------|------|----------|
|      |                              | K           | *F   |          |
| 1    | Preheat in air               | ----        | ---- | -----    |
| 2    | Carburize                    | 1172        | 1650 | 8        |
| 3    | Air cool to room temperature | ----        | ---- | -----    |
| 4    | Copper plate all over        | ----        | ---- | -----    |
| 5    | Reheat                       | 922         | 1200 | 2.5      |
| 6    | Air cool to room temperature | ----        | ---- | -----    |
| 7    | Austenitize                  | 1117        | 1550 | 2.5      |
| 8    | Oil quench                   | ----        | ---- | -----    |
| 9    | Subzero cool                 | 180         | -120 | 3.5      |
| 10   | Double temper                | 450         | 350  | 2 each   |
| 11   | Finish grind                 | ----        | ---- | -----    |
| 12   | Stress relieve               | 450         | 350  | 2        |

TABLE IV. - SPUR GEAR DATA

[Gear tolerance per ASMA class 12.]

|  |                    |
|--|--------------------|
| Number of teeth . . . . .              | 28                 |
| Diametral pitch . . . . .              | 8                  |
| Circular pitch, cm (in.) . . . . .     | 0.9975 (0.3927)    |
| Whole depth, cm (in.) . . . . .        | 0.762 (0.300)      |
| Addendum, cm (in.) . . . . .           | 0.318 (0.125)      |
| Chordal tooth thickness . . . . .      | 0.485 (0.191)      |
| (reference), cm (in.)                  |                    |
| Pressure angle, deg . . . . .          | 20                 |
| Pitch diameter, cm (in.) . . . . .     | 8.890 (3.500)      |
| Outside diameter, cm (in.) . . . . .   | 9.525 (3.750)      |
| Root fillet, cm (in.) . . . . .        | 0.102 to 0.152     |
| (reference), cm (in.)                  | (0.04 to 0.06)     |
| Measurement over pins, . . . . .       | 9.603 to 9.630     |
| cm (in.)                               | (3.7807 to 3.7915) |
| Pin diameter, cm (in.) . . . . .       | 0.549 (0.216)      |
| Backlash reference, cm (in.) . . . . . | 0.0254 (0.010)     |
| Tip relief, cm (in.) . . . . .         | 0.001 to 0.0015    |
| (reference), cm (in.)                  | (0.0004 to 0.0006) |
| Tooth width, cm (in.) . . . . .        | 0.635 (0.25)       |

TABLE V. - PROPERTIES OF SYNTHETIC PARAFFINIC OIL

|   |                              |
|---|------------------------------|
| Additive . . . . .  | <sup>a</sup> Lubrizol 5002   |
| Kinematic viscosity, $\text{cm}^2/\text{sec}$ (cS) at-      |                              |
| 244 K ( $-20^\circ \text{F}$ ) . . . . .                    | $2500 \times 10^{-2}$ (2500) |
| 311 K ( $100^\circ \text{F}$ ) . . . . .                    | $31.6 \times 10^{-2}$ (31.6) |
| 372 K ( $210^\circ \text{F}$ ) . . . . .                    | $5.7 \times 10^{-2}$ (5.7)   |
| 477 K ( $400^\circ \text{F}$ ) . . . . .                    | $2.0 \times 10^{-2}$ (2.0)   |
| Flashpoint, K ( $^\circ \text{F}$ ) . . . . .               | 508 (455)                    |
| Fire point, K ( $^\circ \text{F}$ ) . . . . .               | 533 (500)                    |
| Pour point, K ( $^\circ \text{F}$ ) . . . . .               | 219 (-65)                    |
| Specific gravity . . . . .                                  | 0.8285                       |
| Vapor pressure at 311 K ( $100^\circ \text{F}$ ), . . . . . | 0.1                          |
| mm Hg (or torr)   |                              |
| Specific heat at 311 K ( $100^\circ \text{F}$ ), . . . . .  | 676 (0.523)                  |
| J/kg K (Btu/lb $^\circ \text{F}$ )                          |                              |

<sup>a</sup>Additive, Lubrizol 5002 (5 vol%); content of additive: phosphorus, 0.6 wt%; sulfur, 18.5 wt%.

batch of synthetic paraffinic oil. The physical properties of this lubricant are summarized in Table V. Five percent of an extreme-pressure additive, designated Lubrizol 5002 (partial chemical analysis given in Table V), was added to the lubricant.

### Test Procedure

After the test gears were cleaned to

TABLE VI. - FATIGUE RESULTS WITH AISI 9310 STANDARD AND SHOT-PEENED TEST GEARS

| Gears       | 10-Percent life, cycles | 50-Percent life, cycles | Slope | Failure Index <sup>a</sup> | Confidence number, <sup>b</sup> percent |
|-------------|-------------------------|-------------------------|-------|----------------------------|---|
| Standard    | 19x10 <sup>6</sup>      | 46x10 <sup>6</sup>      | 2.1   | 18/18                      | --                                      |
| Shot peened | 30                      | 68                      | 2.3   | 24/24                      | 83                                      |

<sup>a</sup>Indicates numbers of failures out of total number of tests.  
<sup>b</sup>Probability, expressed as a percentage, that the 10-percent life with the baseline AISI 9310 gears is either less than, or greater than, that of the particular lot of gears being considered.

remove the preservative, they were assembled on the test rig. The 0.635 cm (0.25 in.) wide test gears were run in an offset condition with a 0.30 cm (0.12 in.) tooth-surface overlap to give a load surface on the gear face of 0.28 cm (0.11 in.), thereby, allowing for the edge radius of the gear teeth. If both faces of the gears were tested, four fatigue tests could

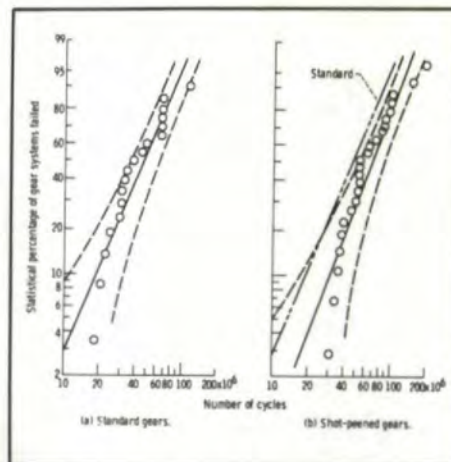

Fig. 4—Comparison of surface (pitting) fatigue lives of standard ground and shot-peened carburized and hardened CVM AISI 9310 steel spur gears. Speed, 10 000 rpm; lubricant, synthetic paraffinic oil; gear temperature, 350 K (170° F); maximum Hertz stress,  $1.7 \times 10^9$  N/m<sup>2</sup> (248 000 psi).

## VIEWPOINT (continued from page 6)

hob manufacturing units in India and I am also doing consultancy work for gear design and manufacturing problems. I have been working in this field for the past fifteen years.

I would be extremely grateful if you could add my name along with the list of qualified people who could get the magazine.

We would also like to have all the earlier issues published.

S. V. Shanmugam  
 Chowgule Matrix Hobs Ltd  
 India

We run a machine shop under UNDP assistance for training and production of spare parts for small scale industries. We would like to subscribe to your magazine GEAR TECHNOLOGY.

Demrew Metaferia  
 National Project Officer  
 Addis Ababa, Ethiopia

I have been asked by several members of our research staff to approach you for the above journal.

Research is an important aspect of our work and the journal would reach a substantial number of people who have a direct influence on purchasing policies of this Department and of "clients". It

would also introduce manufacturers' names to our undergraduates and postgraduate students for their future use.

Hilary M. Pickett  
 Librarian  
 Cambridge University  
 England

Many thanks for your letter. I must confess that the first issue of "GEAR TECHNOLOGY" was well received. In fact, someone pinched my copy. I, therefore, enclose the appropriate draft for one year's subscription plus the necessary addition for the five issues you will already have completed by the time this letter arrives.

Ronald Cowee  
 Gear Machines & Tools Pty. Ltd  
 Marrickville, Australia

We received a complimentary copy of your publication: GEAR TECHNOLOGY at the Fourth International Power Transmission and Gearing conference of the ASME. We found it very interesting. We would like to receive a regular subscription.

Denis St-Georges  
 Project Engineer  
 Commission de transport  
 de la Communauté urbaine  
 de Montreal  
 Canada

be run for each set of gears. All tests were run in at a pitch-line load of 1225 N/cm (700 lb/in.) for 1 hour, which gave a maximum Hertz stress of  $0.756 \times 10^9$  N/m<sup>2</sup> (111 000 psi). The load was then increased to 5784 N/cm (3305 lb/in.), which gave a pitch-line maximum Hertz stress of  $1.71 \times 10^9$  N/m<sup>2</sup> (248 000 psi). At this pitch-line load the tooth root bending stress would be  $0.21 \times 10^9$  N/m<sup>2</sup> (30 000 psi), if plain bending were assumed. However, because there was an offset load, an additional stress was imposed on the tooth bending stress. Combining the bending and torsional moments gave a maximum stress of  $0.26 \times 10^9$  N/m<sup>2</sup> (37 000 psi). This bending stress does not include the effects of tip relief, which would also increase the bending stress.

Operating the test gears at 10 000 rpm gave a pitch-line velocity of 46.55 m/sec (9163 ft/min). Lubricant was supplied to the inlet mesh at 800 cm<sup>3</sup>/min at  $319 \pm 6$  K ( $116^\circ \pm 10^\circ$ F). The lubricant outlet temperature was nearly constant at  $350 \pm 3$  K ( $170^\circ \pm 5^\circ$ F). The tests ran continuously (24 hr/day) until they were automatically shut down by the vibration detection transducer, located on the gearbox adjacent to the test gears. The lubricant circulated through a 5- $\mu$ m fiber-glass filter to remove wear particles. After each test, the lubricant and the filter element were discarded. Inlet and outlet oil temperatures were continuously recorded on a strip-chart recorder.

The pitch-line elasto-hydrodynamic

(EHD) film thickness was calculated by the method of Reference 6. It was assumed, for this film thickness calculation, that the gear temperature at the pitch line was equal to the outlet oil temperature and that the inlet oil temperature to the contact zone was equal to the gear temperature, even though the inlet oil temperature was considerably lower. It is possible that the gear surface temperature was even higher than the outlet oil temperature, especially at the end points of sliding contact. The EHD film thickness for these conditions was computed to be  $0.33 \mu\text{m}$  ( $13 \mu\text{in.}$ ), which gave an initial ratio of film thickness to composite surface roughness  $h/\sigma$  of 0.55 at the  $1.71 \times 10^9 \text{ N/m}^2$  (248 000 psi) pitch-line maximum Hertz stress.

### Results and Discussion

Gears manufactured from CVM AISI 9310 material were tested in pairs until failure or for 500 hours. One-half of the gears were shot peened on the tooth root and profile. Nineteen tests were run with standard-finish ground test gears, and 24 tests were run with standard-finish ground gears that had been shot peened. Test results were analyzed by considering the life of each pair of gears as a system.

Surface (pitting) fatigue results for the standard-finish AISI 9310 gears are shown in Fig. 4(a). These data were analyzed by the method of Reference 7. The 10- and 50-percent fatigue lives were  $18.8 \times 10^6$  and  $46.1 \times 10^6$  stress cycles (31.3 and 76.8 hr), respectively. These results are summarized in Table VI. The failure index (i.e., the number of fatigue failures out of the number of sets tested) was 18 out of 18. A typical fatigue spall is shown in Fig. 5(b). A cross section of a typical fatigue spall is shown in Fig. 5(a). The surface pitting failure occurs slightly below the pitch line in the area of highest Hertz stress and is of subsurface origin.

Pitting fatigue life results for the gears that were shot peened are shown in Fig. 4(b). The failure index was 24 out of 24. A typical fatigue spall for the shot-peened gears is shown in Fig. 6(a). A cross section of a typical fatigue spall for the shot-peened gears is shown in Fig. 6(b). The 10- and 50-percent surface pitting fatigue lives were  $30.1 \times 10^6$  and  $67.5 \times 10^6$  stress cycles (50.3 and 112.6

hr), respectively. These results are summarized in Table VI. The shot-peened gears exhibited a 10-percent fatigue life of 1.6 times that of the standard ground AISI 9310 gears. The confidence number for the difference in life was 83 percent. The mean life ratio for the shot-peened over the standard AISI 9310 gears was 1.5, with a confidence number of 98 percent. The confidence number indicates the percentage of time the relative lives of the material will occur in the same order. The 90-percent confidence bands

for the standard ground and shot-peened AISI 9310 test gears are shown in Fig. 4. A confidence number of 95 percent is equivalent to a  $2\sigma$  confidence level.

It is well known that shot peening produces residual subsurface stresses in steel in addition to the residual stresses produced by case carburizing, hardening, and grinding. It was theorized that the additional residual stresses induced by shot peening should account for the increased life of the shot-peened gears. Therefore, two shot-peened and untested



# NILES GEAR GRINDER

MODEL: ZSTZ 630C3 IN STOCK!

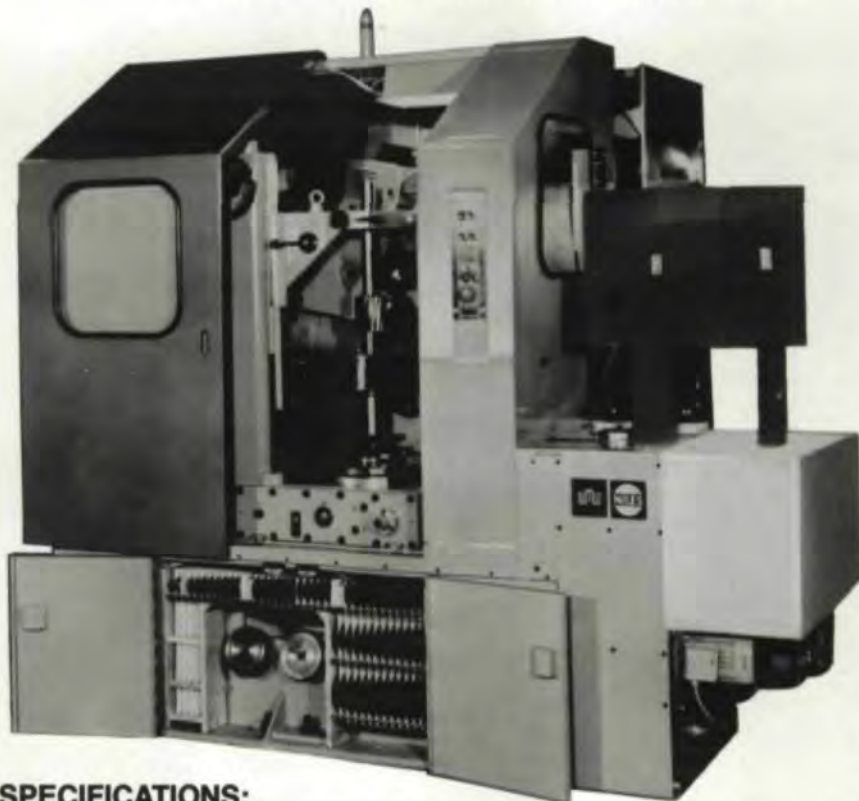

### SPECIFICATIONS:

|                                    |      |                                    |        |
|------------------------------------|------|------------------------------------|--------|
| Outside diameter, max. . . . in.   | 29.5 | Maximum helix angle . deg.         | 45     |
| Root circle diameter, min. . in.   | 2    | Stroke length . . . . . in.        | 8.9    |
| Number of teeth, max. . . . #      | 140  | Double ram strokes                 |        |
| Number of teeth, min. . . . #      | 12   | (Infinitely var.) . . . . . 1/min. | 75-315 |
| Diametral pitch, min. . . . . D.P. | 12.7 | Maximum table load . . lbs.        | 880    |
| Diametral pitch, max. . . . . D.P. | 2.12 | Table bore . . . . . in.           | 3.5    |

**GMW MACHINERY INC.**

**GEAR MACHINERY DIVISION:**

**1665 Tonne Ave., Elk Grove Village, IL 60007**

**Phone (312) 364-4530**

CIRCLE A-21 ON READER REPLY CARD



GMW-Export-Import

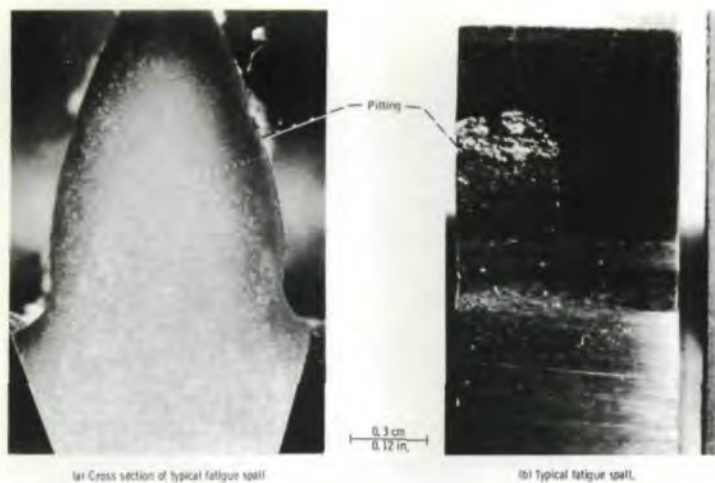

Fig. 5—Fatigue spall for standard ground gear.

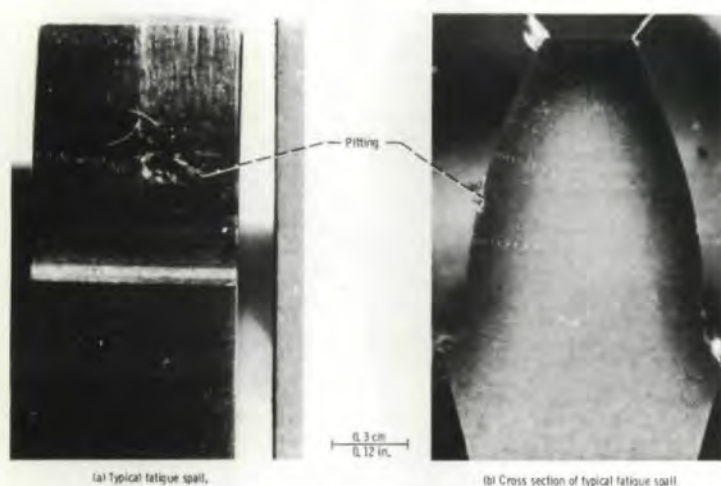

Fig. 6—Fatigue spall for shot-peened gear.

gear teeth and two standard ground and untested gear teeth were subjected to X-ray diffraction residual stress measurements to determine the magnitude of these residual stresses. Residual stress measurements were made near the pitch point at the surface and at nominal subsurface depths of 5, 13, 25, 76, 127, and 254  $\mu\text{m}$  (0.2, 0.5, 1.0, 3, 5, and 10 mil).

Material was removed for subsurface measurement by electropolishing in a sulphuric-phosphoric-chromic acid electrolyte in order to minimize possible alteration of the subsurface residual stress distribution as a result of material removal. All data obtained as a function of depth were corrected for the effects of the penetration of the radiation employed for residual stress measurement into the subsurface stress gradient and for stress relaxation, which occurred as a result of material removal. The method used for the X-ray stress measurements and the calibration procedures used are described in References 8 and 9.

Fig. 7(a) shows two corrected X-ray diffraction residual stress measurements as a function of depth below the surface for the standard ground AISI 9310 gear teeth that had not been shot peened or tested. The high compressive stress on the surface of the gear tooth is the result of grinding and has a very shallow depth that has very little effect on the surface durability of the gear. The lower compressive stress,

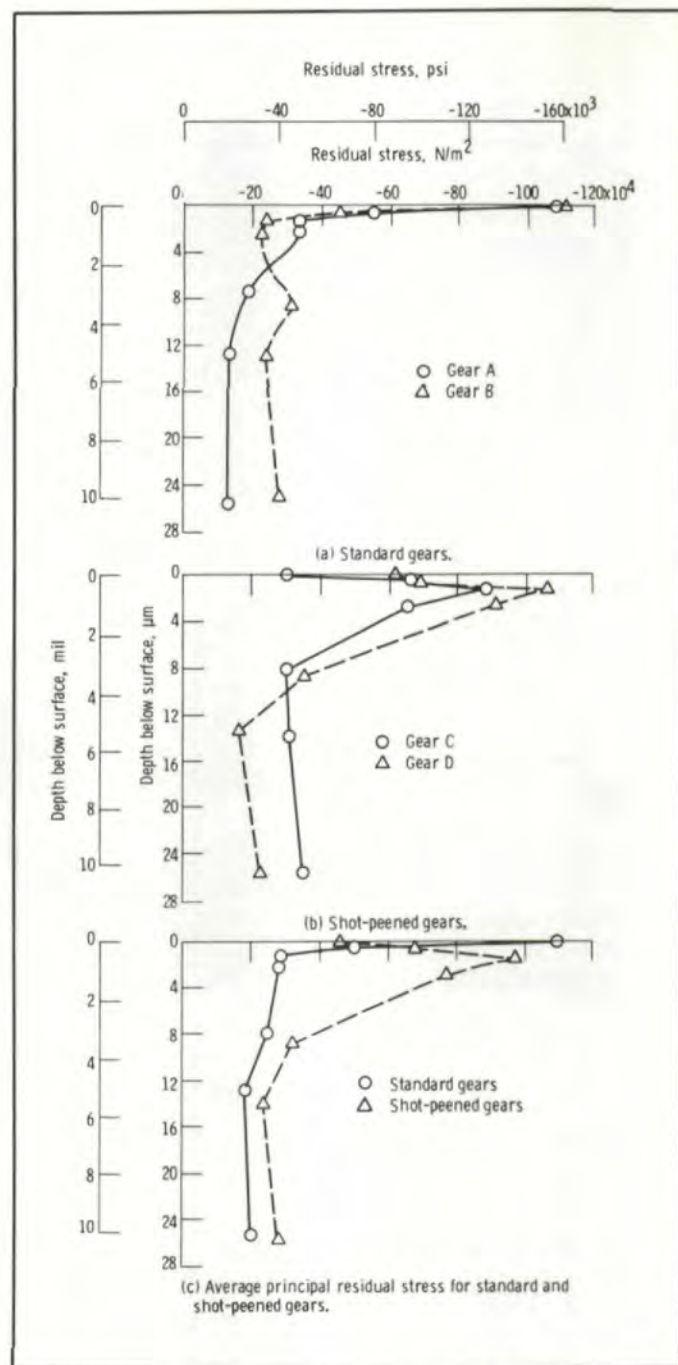

Fig. 7—Principal residual stress as a function of depth below the surface of carburized, hardened, ground and untested AISI 9310 steel spur gear teeth.

which has much greater depth, is from the case carburizing and hardening of the gear tooth surface. This compressive residual stress has a definite beneficial effect on surface fatigue and bending fatigue life.

Fig. 7(b) contains two plots of corrected X-ray diffraction residual stress measurements as a function of depth below the surface in the ground and shot-peened AISI 9310 gear teeth that had not been tested. The high grinding compressive stress on the surface was reduced. A hook in the curve shows a high compressive stress 1.3  $\mu\text{m}$  (0.5 mil) below the surface as a result of the shot peening. The compressive stress at

greater depths below the surface was also increased as a result of the shot peening. It is the increased compressive stress at the greater depths that has the major effect on the surface fatigue life. The depth to the maximum shear stress for the load conditions reported herein was 178  $\mu\text{m}$  (7 mil).

Fig. 7(c) contain plots of the average of the two X-ray residual stress measurements as a function of depth below the surface for both the standard ground and shotpeened gears. This Fig. shows the average increase in the residual compressive stress due to shot peening. At the maximum shear stress depth of 178  $\mu\text{m}$  (7 mil) the average residual compressive stress was increased from  $0.186 \times 10^9 \text{ N/m}^2$  (27 000 psi) in the standard ground AISI 9310 gear to  $0.26 \times 10^9 \text{ N/m}^2$  (37 700 psi) in the ground and shot-peened AISI 9310 gear. From equation (A11), taken from the analysis given in the appendix for maximum shear stress and residual stress,

$$(\tau_{\max})_r = -3.15 \times 10^6 \left( \frac{P_N}{L S_{\max} R} \right) - \frac{1}{2} S_{ry}$$

where

$$R = 7.62 \text{ mm (0.3 in.)}$$

$$S_{\max} = 1.71 \times 10^9 \text{ N/m}^2 \text{ (248 000 psi)}$$

$$\frac{P_N}{L} = 578 \text{ 375 N/m (3305 lb/in)}$$

Therefore for peened gears, in SI units,

$$(\tau_{\max})_r = -21.74 \times 10^9 \frac{578 \text{ 375}}{0.00762 \times 1.71 \times 10^9} - \frac{1}{2} (0.26 \times 10^9) = -0.835 \times 10^9$$

in U.S. customary units,

$$(\tau_{\max})_r = -3.15 \times 10^6 \frac{3305}{0.3 \times 248 \text{ 000}} - \frac{1}{2} (-37 \text{ 000}) = -121 \text{ 080}$$

And for standard gears, in SI units,

$$(\tau_{\max})_r = -21.74 \times 10^9 \frac{578 \text{ 375}}{0.00762 \times 1.71 \times 10^9} - \frac{1}{2} (0.186 \times 10^9) = -0.872 \times 10^9$$

in U.S. customary units,

$$(\tau_{\max})_r = -3.15 \times 10^6 \frac{3305}{0.3 \times 248 \text{ 000}} - \frac{1}{2} (-27 \text{ 000}) = -126 \text{ 430}$$

The surface fatigue life<sup>(10)</sup> for gears is inversely proportional to the maximum shear stress to the ninth power. The

calculated life ratio from measured residual stress is therefore

$$\frac{L_{10p}}{L_{10s}} = \left[ \frac{(\tau_{\max})_{rs}}{(\tau_{\max})_{rp}} \right]^9 = \left( \frac{0.872 \times 10^9}{0.835 \times 10^9} \right)^9 = 1.5$$

This calculated ratio of the fatigue life of the shot-peened gears to that of the standard gear compares favorably with the experimental fatigue life ratio of 1.6.

### Summary of Results

Gear surface fatigue endurance tests were conducted on two groups of carburized and hardened AISI 9310 steel spur gears manufactured from the same heat of material. Both groups were manufactured with a standard ground tooth surface. One group was subjected to an additional shot-peening process on the gear tooth surface and root radius to produce a residual compressive surface stress. The gear pitch diameter was 8.89 cm (3.5 in.). Test conditions were a gear temperature of 350 K (170° F), a maximum Hertz stress of  $1.71 \times 10^9 \text{ N/m}^2$  (248 000 psi), and a speed of 10 000 rpm. The lubricant was a synthetic paraffinic oil with an additive package.

The following results were obtained:

1. The 10-percent surface (pitting) fatigue life of the shot-peened gears was 1.6 times that for the standard test gears that were not shot peened. This was shown to be statistically significant.
2. The calculated 10-percent surface (pitting) fatigue life for the shot-peened gears determined from measured residual subsurface stress was 1.5 times that for the standard gears that were not shot peened.
3. Measured residual stresses for the standard and shot-peened gears show an increase of 40 percent for the shot-peened gears over the standard gears at the depth of maximum shear stress in addition to a 350 percent increase at a depth of 13.0  $\mu\text{m}$  (0.5 mil).

### Appendix – Derivation of Residual Stress Effect on Maximum Shear Stress

It is well known that classical rolling-element fatigue begins in the subsurface zone of maximum shear stress.<sup>(11-12)</sup> Therefore, to determine the effect of residual stress on rolling-element fatigue in gears, it is necessary to analyze the effect of residual stress on the maximum shear stress below the surface. The maximum shear stress at any point in a stressed volume below a rolling line-contact load is

$$(\tau_{\max})_y = \frac{1}{2} (S_z - S_y) \quad (\text{A1})$$

$$(\tau_{\max})_x = \frac{1}{2} (S_z - S_x) \quad (\text{A2})$$

where  $S_z$  is the principal compressive stress in a direction normal to the contact area,  $S_y$  is the principal compressive parallel stress to the direction of rolling,<sup>(13)</sup> and  $S_x$  is the principal stress normal.

For rollers or gear teeth loaded statically, the maximum theoretical shear stress occurs in the  $y$ - $z$  plane since the stress in the  $y$ , or rolling, direction is less than the stress in the  $x$

direction. Therefore, the maximum shear stress is

$$\tau_{\max} = \frac{1}{2}(S_z - S_y) \quad (\text{A3})$$

If the residual stresses are equal in the  $x$  and  $y$  directions, for the line contact in the  $y$ - $z$  plane the maximum shear stress including the residual stress is

$$(\tau_{\max})_r = \frac{1}{2}[S_z - (S_y + S_{ry})] \quad (\text{A4})$$

$$(\tau_{\max})_r = \tau_{\max} - \frac{1}{2}S_{ry}$$

where  $S_{ry}$  is the residual stress in the  $y$  direction and is positive for tensile stress and negative for compressive stress. From Reference 13 for line contact of rollers

$$\tau_{\max} = -0.30025 \frac{b}{\Lambda} \quad (\text{A5})$$

where  $b$  is the half width of the Hertzian contact,

$$b = \frac{2P_N}{\pi L S_{\max}} \quad (\text{A6})$$

and  $\Lambda$  for a contact of two rollers of the same material is

$$\Lambda = 4 \frac{R_1 R_2}{R_1 + R_2} \left( \frac{1 - \delta^2}{E} \right) \quad (\text{A7})$$

If the rollers are of the same radius,

$$\Lambda = 2R \left( \frac{1 - \delta^2}{E} \right) \quad (\text{A8})$$

Where

- $P_N$  normal load, N (lb)
- $S_{\max}$  maximum Hertz stress, N/m<sup>2</sup> (psi)
- $R_1 R_2$  radius of curvature of the two rollers, m (in.)
- $\delta$  Poisson's ratio
- $E$  Young's Modulus, N/m<sup>2</sup> (psi)

Substituting equations (A6) and (A8) into equation (A5) for  $\tau_{\max}$  results in

$$\tau_{\max} = -0.30025 \frac{P_N}{\pi L S_{\max}} \left[ \frac{E}{R(1 - \delta^2)} \right] \quad (\text{A9})$$

If equation (A9) is substituted into equation (A4),

$$(\tau_{\max})_r = -0.30025 \frac{P_N}{\pi L S_{\max}} \left[ \frac{E}{R(1 - \delta^2)} \right] - \frac{1}{2} S_{ry} \quad (\text{A10})$$

For steel gears  $E = 207 \times 10^9$  N/m<sup>2</sup> ( $30 \times 10^6$  psi) and  $\delta = 0.30$ ; therefore, equation (A10) becomes for SI units

$$(\tau_{\max})_r = -21.74 \times 10^9 \frac{P_N}{L S_{\max} R} - \frac{1}{2} S_{ry} \quad (\text{A11a})$$

and for U.S. customary units

$$(\tau_{\max})_r = -3.15 \times 10^6 \frac{P_N}{L S_{\max} R} - \frac{1}{2} S_{ry} \quad (\text{A11b})$$

where  $S_{ry}$  can be either compressive or tensile. When gears are shot peened, the residual stress is compressive and, therefore, reduces the maximum shear stress.

Since the rolling-element fatigue life of gears is inversely proportional to the maximum shear stress to the ninth power,<sup>(14)</sup>

$$\left. \begin{aligned} L &\sim \left( \frac{1}{\tau_{\max}} \right)^9 \\ \text{or} \\ L &\sim \left[ \frac{1}{(\tau_{\max})_r} \right]^9 \end{aligned} \right\} \quad (\text{A12})$$

From equation (A4), where  $(\tau_{\max})_r = \tau_{\max} - 1/2 (S_{ry})$ ,

$$L \sim \left[ \frac{1}{\tau_{\max} - 1/2 (S_{ry})} \right]^9 \quad (\text{A13})$$

using a life ratio of  $L_1$  and  $L_2$

$$\frac{L_1}{L_2} = \left[ \frac{\tau_{\max} - 1/2 (S_{ry})_2}{\tau_{\max} - 1/2 (S_{ry})_1} \right]^9 \quad (\text{A14})$$

When the residual stress developed by the shot peening of the gear teeth is known, the change in life produced by shot peening can be determined from equation (A14).

#### References

1. MOORE, H. F.: "Shot Peening and the Fatigue of Metals." American Foundry Equipment Co., 1944.
2. STRAUB, J. C.: "Shot Peening in Gear Design." AGMA Paper 109.13, June 1964.
3. VALENTINE, K. B.: "Recrystallization as a Measurement of Relative Shot Peening Intensities." Am. Soc. Met. Trans. Q., Vol. 40, 1948, pp. 420-434.
4. ZARETSKY, ERWIN V.; et al.: "Effects of Component Differential Hardness on Residual Stress and Rolling-Contact Fatigue." NASA TN D-2664, 1965.
5. ZARETSKY, E. V.; PARKER, R. J.; and ANDERSON, W. J.: "Component Hardness Differences and Their Effect on Bearing Fatigue." J. Lub. Technol., Vol. 89, No. 1, Jan. 1967, pp. 47-62.
6. DOWSON, D.; and HIGGINSON, G. R.: "Elasto-Hydrodynamic Lubrication." Pergamon Press, 1966, p. 96.
7. JOHNSON, LEONARD G.: "The Statistical Treatment of Fatigue Experiments." Elsevier Pub. Co., 1964.
8. CHRISTENSON, A. L., ed.: "Measurement of Stress by X-Ray." SAE HS-182, Aug. 1971.
9. PREVEY, PAUL S.: "Method of Determining the Elastic Properties of Alloys in Selected Crystallographic Directions for X-Ray Defraction Residual Stress Measurements." Adv. X-Ray Anal., Vol. 20, 1977, pp. 345-354.

(continued on page 48)



## THE PROCESS OF GEAR SHAVING . . .

(continued from page 46)

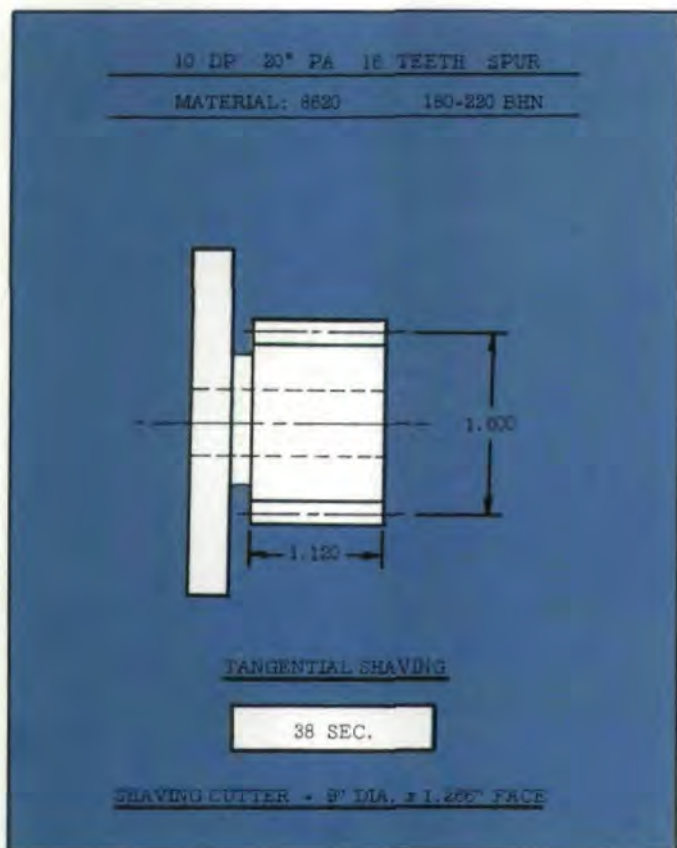

Supplementary 7

E-5 ON READER REPLY CARD

## LOWER GRINDING COST . . .

(continued from page 21)

the truing costs (not included here) these constitute the production costs per flute. This shows that corundum grinding is about 30% more expensive than CBN grinding. The superiority of CBN is likely to increase still further, assuming a rise in the labor and machine costs which determine pro-

Fig. 17—CBN grinds more economically than corundum and gives better quality

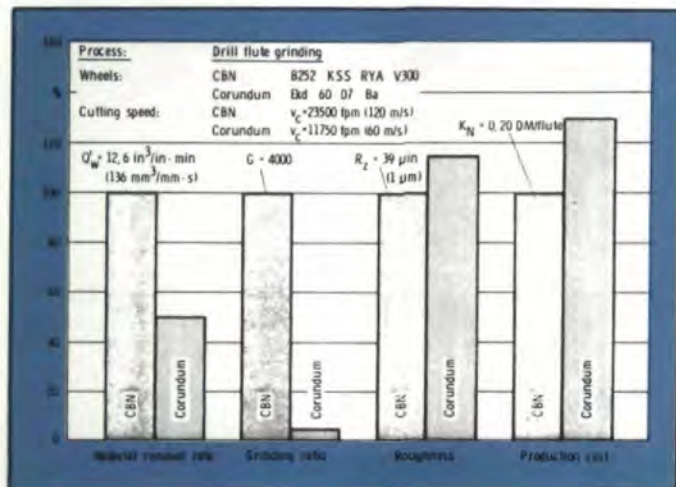

E-1 ON READER REPLY CARD

## EFFECT OF SHOT PEENING . . .

(continued from page 36)

- TOWNSEND, D. P.; COY, J. J.; and ZARETSKY, E. V.: "Experimental and Analytical Load Life Relation for AISI 9310 Steel Spur Gears." Journal of Mechanical Design, Trans. ASME, Vol. 100, No. 1, Jan. 1978, pp. 54-60.
- JONES, A. B.: "Metallographic Observations of Ball Bearing Fatigue Phenomena." Symposium on Testing of Bearings, ASTM, 1947, pp. 35-48; discussion, pp. 49-52.
- CARTER, T. L.: et al: "Investigation of Factors Governing Fatigue Life with the Rolling-Contact Fatigue Spin Rig." Am. Soc. Lubr. Eng. Trans., Vol. 1, No. 1, Apr. 1958, pp. 23-32.
- JONES, A. B.: "New Departure - Analysis of Stress and Deflections." Vol. I, New Departure, Div. Gen. Motors Corp., 1946, pp. 22.
- LUNDBERG, G.; and PALMGREN, A.: "Dynamic Capacity of Rolling Bearings." Acta. Polytech. Scand., Mech. Eng. Ser., Vol. 1, No. 3, 1947.

E-4 ON READER REPLY CARD