

# Flank Load Carrying Capacity and Power Loss Reduction by Minimized Lubrication

B.-R. Höhn, K. Michaelis and H.-P. Otto

*(Printed with permission of the copyright holder, the American Gear Manufacturers Association, 1001 N. Fairfax Street, Fifth Floor, Alexandria, VA 22314-1587. Statements presented in this paper are those of the author(s) and may not represent the position or opinion of the American Gear Manufacturers Association.)*

## Management Summary

Gears are machine components that determine the capability and reliability of many technical products. Continuous demand for higher efficiency and reliability, increased load carrying capacity and endurance life, smaller size, lower noise and vibrations, prolonged service intervals, low environmental impact and low costs will remain the main driving forces in the development of gear drives in the future. The fatigue of contacting surfaces in gears is often the life-limiting factor in transmissions which should, ideally, operate reliably for 20 years or more.

Low oil levels—and, thus, reduced oil quantities—are sometimes used for the reduction of no-load losses in dip-lubricated automotive and industrial transmissions. Specifically, a higher efficiency can be obtained by reducing no-load power losses such as squeezing, splashing and ventilation losses. These losses can be reduced by lowering the oil volume, namely the oil level in dip-lubricated transmissions and the oil flow rate with oil injection lubrication. In these cases, the oil amount required for lubrication may be sufficient, but there may be a lack of cooling oil. This leads to high gear bulk temperatures resulting in thin separating films with higher friction and wear on the mating surfaces and, therefore, an increased risk of gear failures such as scuffing, pitting, micropitting and low-speed wear.

Therefore the objective of this study was to investigate the limits concerning possible reduction of lubricant quantity in gears that could be tolerated without detrimental effects on their load carrying capacity.

## Introduction

The lubrication of gears has two major functions: Reducing friction and wear as well as dissipating heat. The power losses, especially the no-load losses, lessen with decreasing immersion depth using dip lubrication. The load-dependent gear power losses are nearly unaffected by minimized lubrication. However, the gear bulk temperatures rise dramatically by using minimized lubrication due to a lack of heat dissipation.

With minimized lubrication, the scuffing load carrying capacity decreased by up to 60%, compared to rich lubrication conditions. Therefore, the dominating influence of the bulk

temperature is very clear. Starved lubrication leads to more frequent metal-to-metal contact and the generation of high, local flash temperatures must be considered. An additional factor for the scuffing load carrying capacity calculation in case of minimized lubrication conditions is proposed.

Concerning pitting damage, test runs showed that by lowering the oil level, the load cycles without pitting damage decreased by approximately 50% and up to 75% for minimized lubrication, compared to the results with rich lubrication conditions. The allowable contact stress is clearly reduced (up to 30%) by minimized lubrication. A reduced oil film thick-

**continued**

ness as a consequence of increased bulk temperatures results in more frequent metal-to-metal contacts causing a higher surface shear stress. In combination with a decreased material strength due to a possible tempering effect at high bulk temperatures, the failure risk of pitting damage is clearly increased. The common pitting load carrying capacity calculation algorithms—according to DIN/ISO—are only valid for moderate oil temperatures and rich lubrication conditions. For increased thermal conditions, the reduction of the pitting endurance level at increased gear bulk temperatures can be approximated with the method of Knauer (FZG TU München, 1988). An advanced calculation algorithm for pitting load carrying capacity calculation at high gear bulk temperatures (valid for high oil temperatures as well as for minimized lubrication) is proposed.

The micropitting risk was increased by low oil levels, especially at high loads and during the endurance test. The micropitting damage is caused by poor lubrication conditions that are characterized by a too-low, relative oil film thickness due to high bulk temperatures. Again, the actual bulk temperatures are of major significance for calculation of the micropitting load carrying capacity.

The wear rate of the gears is almost unaffected by the oil level. Only a slight increase of wear could be observed with minimized lubrication. This increase can be explained by the higher bulk temperature of the gears running under minimized lubrication conditions. The investigations showed that there exists a natural limitation for lowering the oil quantity in transmissions without detrimental influence on the load carrying capacity. Knowing these limitations enables the user to determine the possible potential benefits of reduced oil lubri-

cation. The correct prediction of the actual gear bulk temperatures is of major importance in this context. A method for the estimation of the gear bulk temperature at reduced immersion depth under poor lubrication conditions is proposed.

Gears are machine components that determine the capability and reliability of many technical products. Continuous demand for higher efficiency and reliability, increased load carrying capacity and endurance life, smaller size, lower noise and vibrations, prolonged service intervals, low environmental impact and low costs will remain the main driving forces in the development of gear drives in the future. The fatigue of contacting surfaces in gears is often the life-limiting factor in transmissions which should, ideally, operate reliably for 20 years or more.

Low oil levels—and, thus, reduced oil quantities—are sometimes used for the reduction of no-load losses in dip-lubricated automotive and industrial transmissions. Specifically, a higher efficiency can be obtained by reducing no-load power losses such as squeezing, splashing and ventilation losses. These losses can be reduced by lowering the oil volume, namely the oil level in dip-lubricated transmissions and the oil flow rate with oil injection lubrication. In these cases, the oil amount required for lubrication may be sufficient, but there may be a lack of cooling oil. This leads to high gear bulk temperatures resulting in thin separating films with higher friction and wear on the mating surfaces and, therefore, an increased risk of gear failures such as scuffing, pitting, micropitting and low-speed wear.

Therefore the objective of this study was to investigate the limits concerning possible reduction of lubricant quantity in gears that could be tolerated without detrimental effects on

**Table 1—Main geometrical data of test gears**

Parameter	Symbol	Unit	C	A
Center distance	$a$	mm	91.5	91.5
Number of teeth pinion	$z_1$	--	16	16
Number of teeth gear	$z_2$	--	24	24
Normal module	$m_n$	mm	4.5	4.5
Normal pressure angle	$\alpha_n$	°	20	20
Face width	$b$	mm	14	20
Profile shift factor pinion	$x_1$	--	0.182	0.864
Profile shift factor gear	$x_2$	--	0.172	-0.500
Material		--	16MnCr5	20MnCr5

**Table 2—Properties of used lubricants**

Name		RL133	FVA2 + 4% A99	FVA 3 + 6.5% A99	FVA 3 pure	M220 + 4% A99
Abbreviation		RL133	FVA2A	FVA3A	FVA3	M220A
ISO VG		100	32	100	100	200
Kinematic viscosity at 40 C (mm <sup>2</sup> /s)	$\nu_{40}$	101.4	29.8	95	950	210
Kinematic viscosity at 100 C (mm <sup>2</sup> /s)	$\nu_{100}$	13.45	5.2	10.7	10.7	19
Density (at 15 C) (kg/m <sup>3</sup> )	$\rho_{15}$	892	871	872	872	895

their load carrying capacity.

### Test Apparatus

**Test gears.** Table 1 shows the main geometrical values of the two gear types used in this investigation.

For all investigations on the flank load carrying capacity under minimized—as opposed to rich—lubrication conditions, standard test gears (Table 1) were used. For the investigations on pitting and wear, gear type C-PT (“PT” stands for pitting) was used. For evaluation of the micropitting load carrying capacity, gear type C-GF (“GF” stands for Grauflecken, the German word for micropitting), was used (Ref. 4). The gear type C has a close to practical design with a well-balanced sliding speed distribution along the path of contact. For the conducted scuffing tests, gear type A (Ref. 3) was used. Gear type A has an uneven sliding speed distribution along the path of contact in order to increase the scuffing risk—especially towards the tip of the pinion. The ground flanks of the test gears had a mean roughness of  $Ra = 0.2 \mu\text{m}$ – $0.4 \mu\text{m}$  for gear types C-PT and A, respectively.  $Ra = 0.4 \mu\text{m}$ – $0.6 \mu\text{m}$  (gear type C-GF). The higher roughness of gear type C-GF increases the risk for the gear-failure-mode micropitting. The mean surface roughness is the only difference between C-PT and C-GF.

**Type of lubrication.** For the investigations of power loss and bulk temperature for dip lubrication, seven different immersion depths at standstill were chosen (Fig. 1).

For the main scuffing, pitting, micropitting and wear tests, an immersion depth of one and three times the module of the gear was chosen.

An oil/air lubrication device (Fig. 2) was used to lubricate the gears with an oil-air mixture and the bearings with plain oil.

It is a lubrication system in which small, measured quantities of oil from the reservoir are introduced into an air/oil mixing device that is connected via a lubricant supply line to the gear set. The air velocity transports the oil along the interior walls of the lubricant line to the point of application. The continuous air stream to the gear set is only the transporting medium for very small oil quantities—only some milliliters per hour.

Oil/air lubrication is used for tests under severe, starved lubrication conditions where the gear mesh is lubricated in order to decrease friction and wear, but no heat dissipation by cooling oil is available due to the very low oil quantities.

**Lubricants.** For the tests at different immersion depths and corresponding oil quantities, the FVA reference oils FVA 3 pure, FVA2A and FVA3A (with a high EP-additive content in order to prevent scuffing during the efficiency and bulk temperature experiments), M220 (a mixture of FVA3A and FVA4A) and the CEC reference oil RL 133 were used (Table 2).

**Test rig.** For all durability tests (pitting, micropitting and wear) and the scuffing tests, a standard FZG back-to-back test rig (Ref. 5; Fig. 3) with a pitch-line velocity of 8.3 m/s was used. For the wear tests at 0.05 m/s, a speed reducer was installed between the motor and drive gear. For the test program at a pitch-line velocity of 30 m/s, one of the FZG test rigs was equipped with a variable speed, three-phase asynchronous

continued

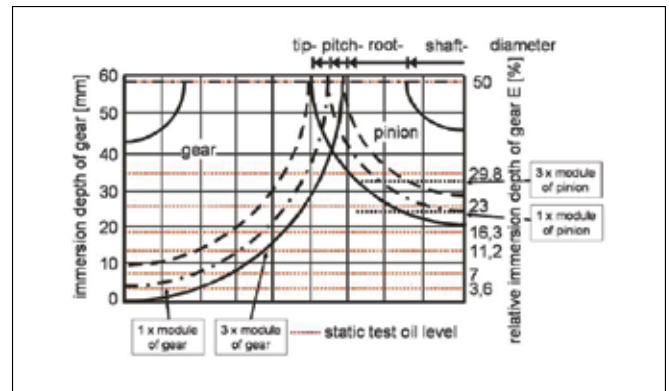

Figure 1—Oil levels at standstill for testing for dip lubrication.

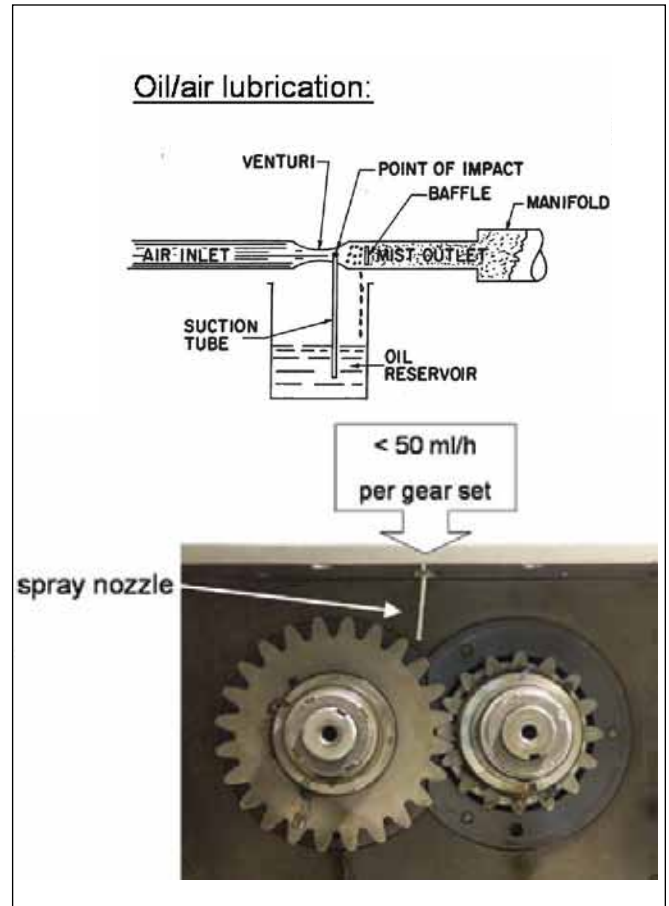

Figure 2—Oil/air lubrication device.

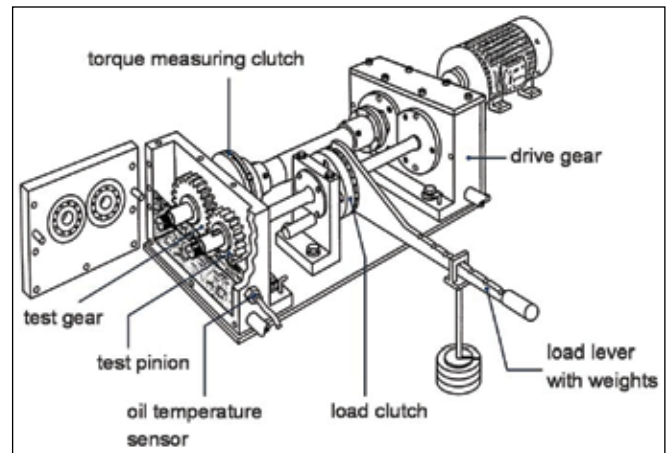

Figure 3—FZG back-to-back test rig.

motor and a speed increaser.

The main elements of the test rig are the two connected gearboxes and an engine behind the drive gear. The test gearbox has an easily removable front and top plate in order to enable a quick change of the test gears. The two spur gear units (test and drive gear set) are connected by two parallel shafts.

In order to put a specific load on the gear flanks, one of the shafts can be divided into two separate parts connected with the load clutch. With the load lever and different weights, a defined torsion can be generated. Table 3 shows the different load stages  $L_s$  in the FZG scuffing, pitting and micropitting test, the corresponding pinion torque  $T_1$  and the Hertzian stress at the pitch point  $p_c$ .

The great advantage of the closed power loop is that the engine only has to provide the power loss of the two gearboxes.

Therefore the back-to-back test rig can also be used for efficiency tests by installing a torque- and-speed measuring device on the input shaft.

Too, one tooth of the pinion and one tooth of the gear can be equipped with a bulk temperature sensor in order to measure the actual gear bulk temperatures for different operational conditions.

#### Power Loss and Bulk Temperature with Minimized Lubrication

**Load-dependent and no-load losses.** Using either dip lubrication with high to very low oil levels, or oil/air lubrication at very low oil quantities, showed no significant change in the load-dependent losses (Fig. 4) and is in excellent agreement with the theoretical values calculated according to Ohlendorf (Ref. 10).

The friction regime is obviously not changed by using minimized lubrication; even small oil quantities (less than 30 ml per hour) are able to reduce friction in the gear mesh, quite the same as with abundant lubrication (oil level up to centerline of the gears).

Tests with oil/air lubrication—compared to tests with oil-moistened gears—showed the importance of a continuous lubrication. Otherwise, an immediate scuffing damage is the fatal consequence.

The no-load losses, which are dominated by the gear splashing and squeezing losses, decreased significantly with decreasing immersion depth (Fig. 5).

Using oil/air lubrication with oil quantities below 100 ml/h results in very low, no-load losses when compared to dip lubrication with high, medium and very low immersion depths. No splashing and almost no squeezing effect can be observed in this case.

**Gear bulk temperatures.** The bulk temperature of gears has a strong influence on the load carrying lubricant film. Increasing temperatures result in decreasing oil viscosity, which in turn produces thinner oil films under constant load and speed conditions.

According to Oster (Ref. 11), the bulk temperature  $\vartheta_M$  of the gears can be calculated based on the idea that the generated heat in the tooth contact is dissipated by the tooth surface area to the surrounding oil, which works as a cooling fluid with the following empirical equation:

$$\vartheta_M = \vartheta_L + 7400 \left( \frac{P_{VZP}}{a b} \right)^{0.72} \frac{X_S}{1.2 X_{Ca}} \quad (1)$$

Where:

- $\vartheta_M$  Gear bulk temperature, °C
- $\vartheta_L$  No-load oil temperature, °C
- $P_{VZP}$  Load dependent gear losses, W
- $a$  Center distance, mm
- $b$  Tooth width, mm
- $X_S$  Lubrication coefficient
- $X_{Ca}$  Profile modification coefficient

**Table 3—Load stage  $L_s$ , pinion torque  $T_1$ , and Hertzian stress at pitch point  $p_c$**

Load stage, $L_s$ (-)	FZG scuffing test		FZG pitting test		FZG micropitting test	
	Torque, $T_1$ , (Nm)	Hertzian stress at pitch point, $p_c$ , (N/mm <sup>2</sup> )	Torque, $T_1$ , (Nm)	Hertzian stress at pitch point, $p_c$ , (N/mm <sup>2</sup> )	Torque, $T_1$ , (Nm)	Hertzian stress at pitch point, $p_c$ , (N/mm <sup>2</sup> )
1	3.3	146	3.3	172	3.3	172
2	13.7	295	13.7	346	13.7	346
3	35.3	474	35.3	565	28.8	510
4	60.8	621	60.8	741	46.6	649
5	94.1	773	94.1	922	70.0	795
6	135.3	927	135.3	1,105	98.9	945
7	183.4	1,080	183.4	1,287	132.5	1,094
8	239.3	1,232	239.3	1,470	171.6	1,245
9	302.0	1,386	302.0	1,651	215.6	1,395
10	372.6	1,538	372.6	1,834	265.1	1,547
11	450.1	1,691	450.1	2,016	319.3	1,698
12	534.5	1,841	534.5	2,197	378.3	1,848

The factor  $X_s$  is set to 1.0 in the case of dip lubrication, and to 1.2 in the case of oil-injection lubrication. The equation for the bulk temperature does not differentiate between pinion and gear nor does it take into account different immersion depths for dip lubrication or the rotational direction (Fig. 6).

From the experimental data, a simple equation is derived that allows calculation of a mean  $X_s$  factor for different immersion depths and rotational directions for gear types A and C in the FZG test rig:

$$0.3 \leq X_s = 0.35 \left( \frac{e}{d_a} \right)^{-D} \leq 3.7 \quad (2)$$

Where:

- $e$  Immersion depth of gear, mm
- $d_a$  Tip diameter of gear, mm
- $D$  Parameter for rotational direction

With:

$D = 0.75$  for the standard (meaning long distance between oil sump and gear mesh) rotational direction, and  $D = 0.5$  for the reversed rotational direction, meaning direct transportation of cooling oil to the gear mesh.

For oil/air lubrication, a constant  $X_s = 3.7$  can be used that indicates starved lubrication without any heat dissipation by cooling oil, but only by convection and conduction to the surrounding metal components.

Several negative consequences arise from high bulk temperatures:

- Decreasing oil film thickness
- Shift from mixed lubrication conditions to boundary lubrication conditions
- Higher degree of metal-to-metal contacts
- Higher local surface shear stress
- Reduced material strength due to possible tempering

All these effects have a negative influence on wear, scuffing, micropitting and pitting. This amounts to an overall negative influence on the durability of the gears.

### Flank Load Carrying Capacity with Minimized Lubrication

**Scuffing investigations.** Scuffing is an instantaneous form of damage caused by the occurrence of solid-phase welding between sliding surfaces in the area of high sliding speed. Gear scuffing is characterized by material transfer between the sliding tooth surfaces—it destroys the flanks of the gears in the direction of the involute and in the direction of the face width.

The scuffing tests were performed according to the standard test procedure described in ISO 14635 (Ref. 5).

The scuffing load carrying capacity with oil/air lubrication at the medium pitch-line velocity of  $v = 8.3$  m/s is comparable to that obtained with minimized dip lubrication with one or three times module immersion depth of the gear. At the high pitch-line velocity, the decrease of the scuffing torque due to oil/air lubrication was even stronger (Fig. 7).

The calculation methods for the scuffing load carrying capacity published in DIN 3990 (Ref. 1) and ISO/TR 13989 (Ref. 7), the flash and integral temperature methods are based on the idea that if the local surface temperature (bulk temperature plus local flash temperature) exceeds a permissible

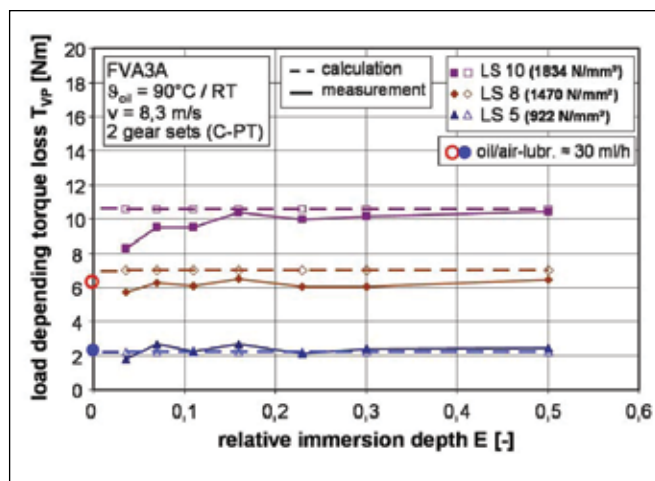

Figure 4—Load-dependent torque losses with minimized dip and oil/air lubrication (Ref. 12).

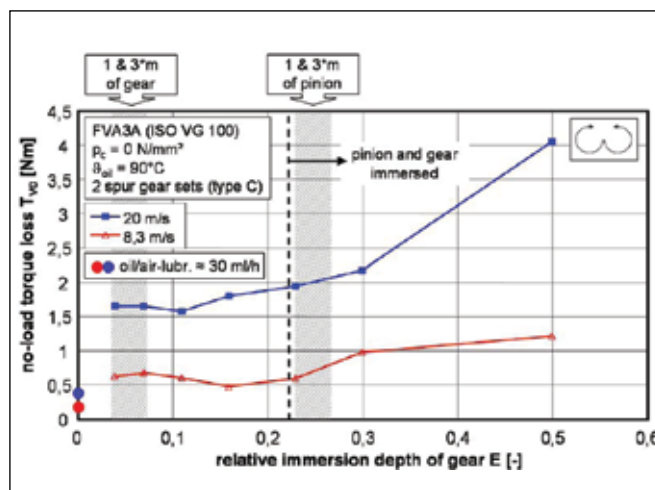

Figure 5—No-load torque losses with minimized dip and oil/air lubrication (Ref. 12).

contact temperature, scuffing occurs. In contrast to the flash temperature method, the integral temperature method averages the flash temperature and supplements empirical influence factors.

According to the integral temperature method, which was presented first by Michaelis (Ref. 9), scuffing damage occurs if a mean critical flank temperature, called integral temperature  $\vartheta_{int}$  exceeds the allowable integral temperature  $\vartheta_{int,allow}$ .

A lower allowable integral temperature with decreasing immersion depth is the main result of the conducted investigations for both pitch-line velocities and for both rotational directions (Fig. 8). A maximum decrease of the permissible integral temperature of approximately 25% to 30%—by using minimized lubrication—can be observed.

Despite the fact that calculations of the integral temperatures were based on the measured bulk temperatures, a clear decrease of the permissible integral temperature could still be observed. Therefore, the increase of the bulk temperatures due to an increasing lack of cooling oil with minimized lubrication is not the only reason for a decreased scuffing capacity—i.e., the lubricant supply to the gear mesh must also be taken into consideration.

Therefore, the integral temperature can be calculated with

continued

the modified equation:

$$\vartheta_{int} = \vartheta_M + C_2 C_{LS} \vartheta_{flaint} \quad (3)$$

Where:

- $\vartheta_{int}$  Integral temperature, °C
- $\vartheta_M$  Actual bulk temperature, °C
- $C_2$  Weighting factor ( $C_2 = 1.5$  for spur gears)

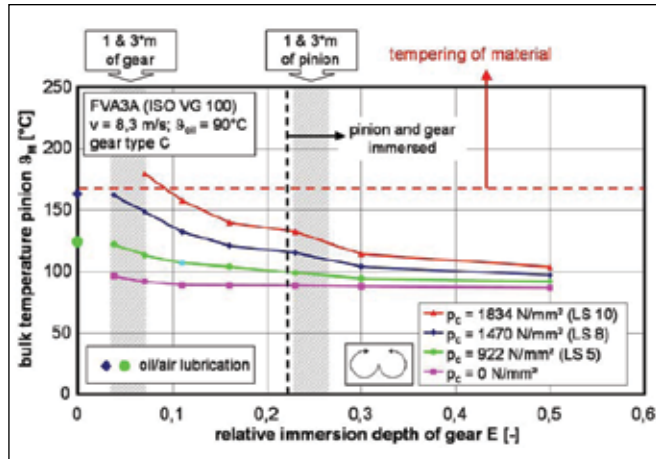

Figure 6—Pinion bulk temperature with minimized dip and oil/air lubrication (Ref. 12).

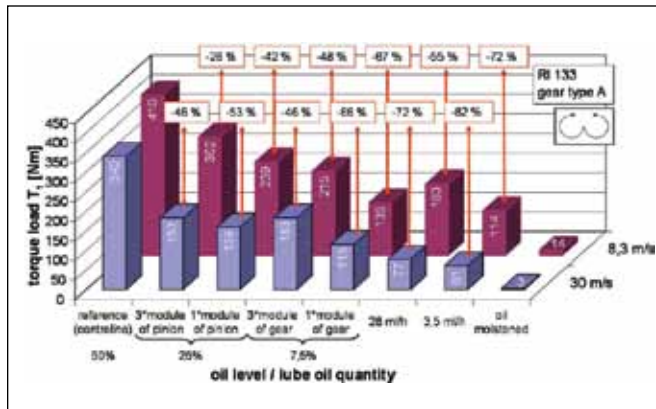

Figure 7—Scuffing load carrying capacity with minimized dip and oil/air lubrication (Ref. 12).

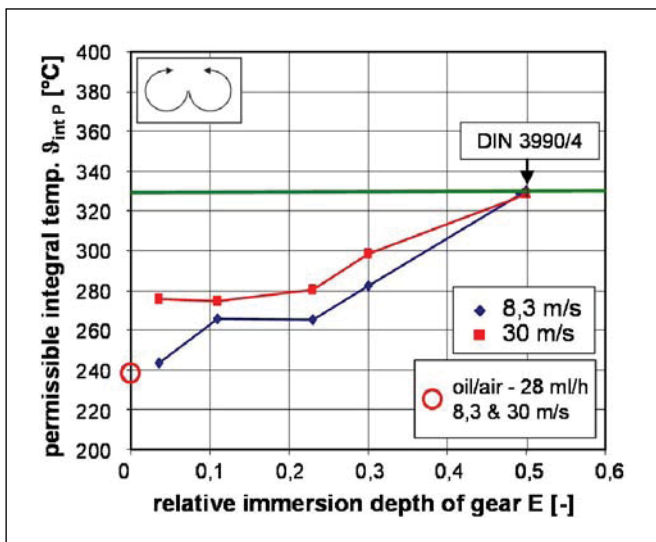

Figure 8—Permissible integral temperature with minimized dip and oil/air lubrication (Ref. 12).

- $C_{LS}$  Lubricant supply factor
- $\vartheta_{flaint}$  Flash integral temperature, °C

The factor  $C_{LS}$ , which takes the lubricant supply to the gear mesh into account, can be roughly estimated (Table 4). Due to a partial lack of lubricant on the gear flank, the local flash temperature is probably increased due to a higher coefficient of friction.

For judging the scuffing performance of a candidate oil under full and minimized lubrication conditions, it should be tested on the FZG test rig close to the actual practical application (speed, oil level, oil supply to gear mesh, etc.). Scuffing tests close to the actual pitch-line velocity, with an oil level up to the centerline and a reduced oil level below three times the module of the gear, should be run. In this way the permissible integral temperature can be calculated from the test results.

In order to transfer the test results to practical applications, the actual gear bulk temperature has to be either calculated or, preferably, measured.

**Pitting investigations.** Pitting damage is a fatigue failure mode that occurs if the material strength is exceeded locally or across the whole width of the tooth by the imposed stress. Typically, pits are the result of surface or subsurface fatigue cracks caused by local metal-to-metal contact at the roughness peaks.

The pitting tests were performed according to the standard test procedure described in the FVA Information Sheet No. 2/ IV (Ref. 14).

By lowering the oil level from the centerline to three times the module of the gear, the endurance limit decreases clearly by  $-8\%$  (Fig. 9). In lowering the oil level to only one time the module of the gear, the endurance limit decreases compared to the one for centerline significantly—by  $-23\%$  (Fig. 9).

The calculation of the surface durability concerning pitting damage for spur gears is based on the contact stress at the inner point of single pair contact B or the contact at the pitch point C, whichever is greater.

The allowable contact stress  $s_{HP}$  can be calculated knowing the endurance limit  $s_{Hlim}$  with Equation 4:

$$\sigma_{HP} = \frac{\sigma_{Hlim} Z_{NT}}{S_{Hmin}} Z_L Z_v Z_R Z_W Z_X \quad (4)$$

Where:

- $s_{HP}$  Allowable contact stress, N/mm<sup>2</sup>
- $s_{Hlim}$  Endurance limit for contact stress N/mm<sup>2</sup>
- $Z_{NT}$  Life factor for contact stress
- $S_{Hmin}$  Required safety factor
- $Z_L$  Lubricant factor
- $Z_v$  Speed factor
- $Z_R$  Surface roughness factor
- $Z_W$  Material factor
- $Z_X$  Size factor

The lubricant factor  $Z_L$  accounts for the influence of the lubricant viscosity, the speed factor  $Z_v$  accounts for the influence of the pitch-line velocity and the roughness factor  $Z_R$  accounts for the influence of the surface roughness on the sur-

face endurance capacity.

For the tests with minimized lubrication at a pitch-line velocity of 8 m/s and 30 m/s, the values for the endurance limit  $s_{Hlim}$  (Fig. 10) can be read from the S-N curves. The endurance limit  $s_{Hlim}$  is a material factor that should be equal for all tests if the calculation algorithm of the standard takes all operational conditions of the conducted tests correctly into account.

However, testing of gear type C-PT with rich and poor lubrication conditions resulted in a significantly reduced endurance strength  $s_{Hlim}$  with minimized lubrication (Fig. 10). The lubricant factor  $Z_L$ , the roughness factor  $Z_R$  and the speed factor  $Z_v$  of DIN 3990 (Ref. 2) or ISO 6336 (Ref. 6) obviously do not fully take into account the actual tribological conditions in the tooth contact, especially the operating viscosity. Due to a lack of sufficient cooling oil, gear bulk temperatures rose dramatically. This results in a reduction of the material strength due to tempering effects and high surface shear stress due to low oil film thicknesses caused by low operating oil viscosities. Knauer (Ref. 8) investigated these effects with oil injection lubrication at medium to high oil temperatures. He derived from his experiments the empirical factors  $Z_g$ ,  $Z_\lambda$  and  $Z_\mu$ .

The pitting tests with minimized dip and oil/air lubrication showed that these factors can also be used for poor lubrication conditions.

The factors  $Z_L$ ,  $Z_v$  and  $Z_R$  of the present standard can therefore be replaced by  $Z_g$ ,  $Z_\lambda$  and  $Z_\mu$ . Thus the correct endurance strength  $s_{Hlim}$  for gears running under increased operational temperatures can be calculated by taking into account the actual thermal conditions in the tooth contact. The allowable contact stress  $s_{HP}$  can be calculated correctly for the usual value for the endurance limit  $s_{Hlim}$  using Equation 5:

$$\sigma_{HP} = \frac{\sigma_{Hlim} Z_{NT}}{S_{Hmin}} 1.1 Z_\lambda Z_\mu Z_g Z_w Z_x \quad (5)$$

In essence, the pitting load carrying capacity is strongly correlated to the actual thermal operating conditions. Knowing the actual gear bulk temperatures enables precise prediction of pitting lifetime and endurance limit.

**Micropitting investigations.** Micropitting damage is a fatigue-failure mode and occurs normally below the pitch line in the area of negative sliding and consists of microscopic disruptions.

Because of these disruptions, the flank starts to look grey in the affected area. With increasing running time, the whole flank can be damaged by micropitting.

The micropitting tests were performed according to the standard test procedure described in the FVA Information Sheet Nr. 54/1-IV (Ref. 4).

Micropitting tests with minimized lubrication were conducted at an oil temperature of 60°C. Considering the whole test, the profile deviation for different oil levels is almost the same during the first load stages (load stages 5 to 8) and starts to increase for the two low immersion depths during load stage 9 and 10 compared to the reference test, with an oil level up to the centerline (Fig. 11).

The test done with dip lubrication at low oil levels only showed a higher profile deviation in load stage 9 during the

stepwise test compared to the test with high oil levels.

The test gears running with oil/air lubrication show a higher profile deviation already after the test run in load stage 6. Obviously the greater increase of the bulk temperature, which results in a lower oil film thickness, with the test gears running with oil/air lubrication results in a higher micropitting risk.

An expanded calculation method is presented by Schrade (Ref. 15) which evaluates a safety factor against the occurrence of micropitting. The evaluation is based on the assumption that micropitting can occur if the minimum relative oil film thickness GF at any point in the entire zone of action is lower than a corresponding critical value  $\lambda_{GFP}$ , which is the limiting permissible relative oil film thickness. A micropitting safety factor can be determined by comparing the minimum relative oil film thickness with the corresponding critical value that is derived from gear testing of the lubricant (e.g., FZG micropitting test; Fig. 12).

continued

Lubricant supply conditions	CLS
Good	1
Medium	1.3 - 1.6
Poor	1.8 - 2.2

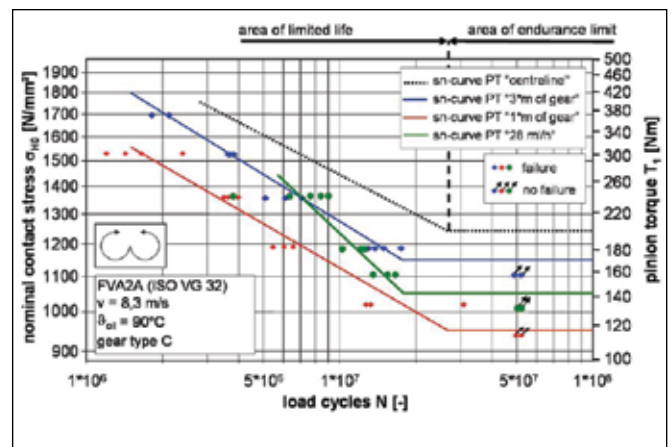

Figure 9—S-N curves for pitting damage using different immersion depth and oil/air lubrication at medium pitch-line velocity of 8.3 m/s ( $P_A = 50\%$ ).

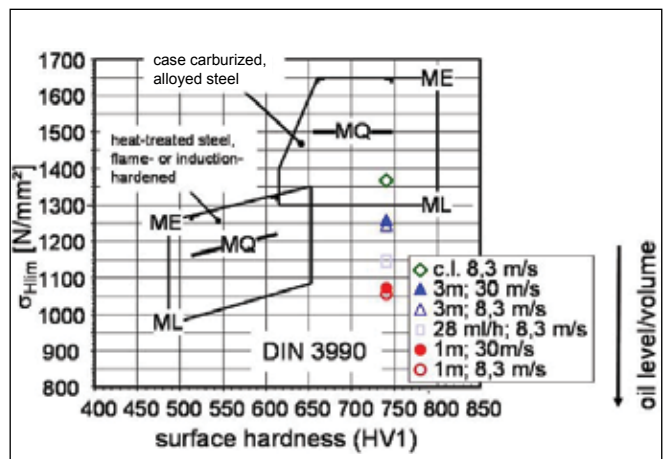

Figure 10—Endurance limit for contact stress  $\sigma_{Hlim}$  according to DIN 3990 or ISO 6336 (Ref. 6).

The micropitting safety factor is strongly related to the relative oil film thickness, which is dominated by the local contact temperature.

The micropitting tests with gear type C-GF showed an increasing risk of profile deviations when using minimized lubrication. As the calculation algorithm for prediction of the micropitting load carrying capacity is strongly determined by the actual lubrication conditions in the tooth contact (local flash temperatures, actual gear bulk temperatures, local Hertzian stress, local sliding speed and local oil film thickness), the test results with minimized lubrication are in good accordance with the state of art. Of major influence are the actual bulk temperatures, which have to be either calculated or measured for prediction of the micropitting risk of actual applications.

**Slow-speed wear investigations.** Wear is a continuous stock removal on the active gear flank. The course of wear failure is a continuous removal of material in every load cycle. The results are scratches over the whole flank. In contrast, scuffing failure is a sudden damage with a comparable scratch structure in the tooth height direction. Due to low sliding velocities in the area of the operating pitch point, scuffing failures are limited to the areas of the addendum and dedendum flank. With increasing running time a profile form deviation starting below and above the pitch line and finally on the whole flank can be observed.

The slow-speed wear tests were performed according to the standard test procedure described in the DGMK Information Sheet, Project No. 377 (Ref. 1). The wear tests with FVA3 with dip lubrication were conducted using the reference oil level (centerline) and three times and one times the module immersion depth of the gear. The wear slightly increases with decreasing immersion depth or by using minimized oil/air lubrication (Fig. 13).

No basic change can be observed concerning the low-speed wear failure with minimized oil/air lubrication. Due to the low pitch-line velocities and therefore low sliding speed

between the contacting surfaces in the gear mesh, low losses are generated. Therefore the small amount of oil is sufficient for the necessary heat dissipation.

Wear is the result of sliding and pressure acting on the contacting surfaces of flanks. The amount of wear is determined by the relative oil film thickness  $l$  related to sliding speed, contact pressure, lubricants, surface structure as well as oil additives and oil contaminants.

According to Plewe (Ref. 13), a linear wear coefficient  $c_{lr}$  can be evaluated from the measured weight loss of the pinion running under different lubrication conditions by taking into account the number of load cycles during the test run. For evaluation of the slow-speed wear category the linear wear coefficient can be plotted over the minimum oil film thickness  $h_{min}$  at the pitch point (Fig. 14).

The slow-speed wear tests with gear type C showed nearly no effect of minimized lubrication conditions compared to rich lubrication conditions. Again the actual bulk temperatures, which increase due to a lack of sufficient cooling oil, have a dominating influence. Knowing the actual temperatures allows a precise calculation of the wear rate with starved lubrication conditions.

### Conclusion

The investigations showed that there exists a natural limitation for lowering the oil quantity in transmissions without detrimental influence on the load carrying capacity.

In summary, minimized lubrication had a negative influence on the load carrying capacity of the standardized test gears.

Due to the increased bulk temperatures resulting from a lack of cooling oil with low immersion depths, the scuffing load carrying capacity was strongly decreased. With minimized lubrication, the scuffing load carrying capacity decreased by more than 60%, compared to rich lubrication conditions.

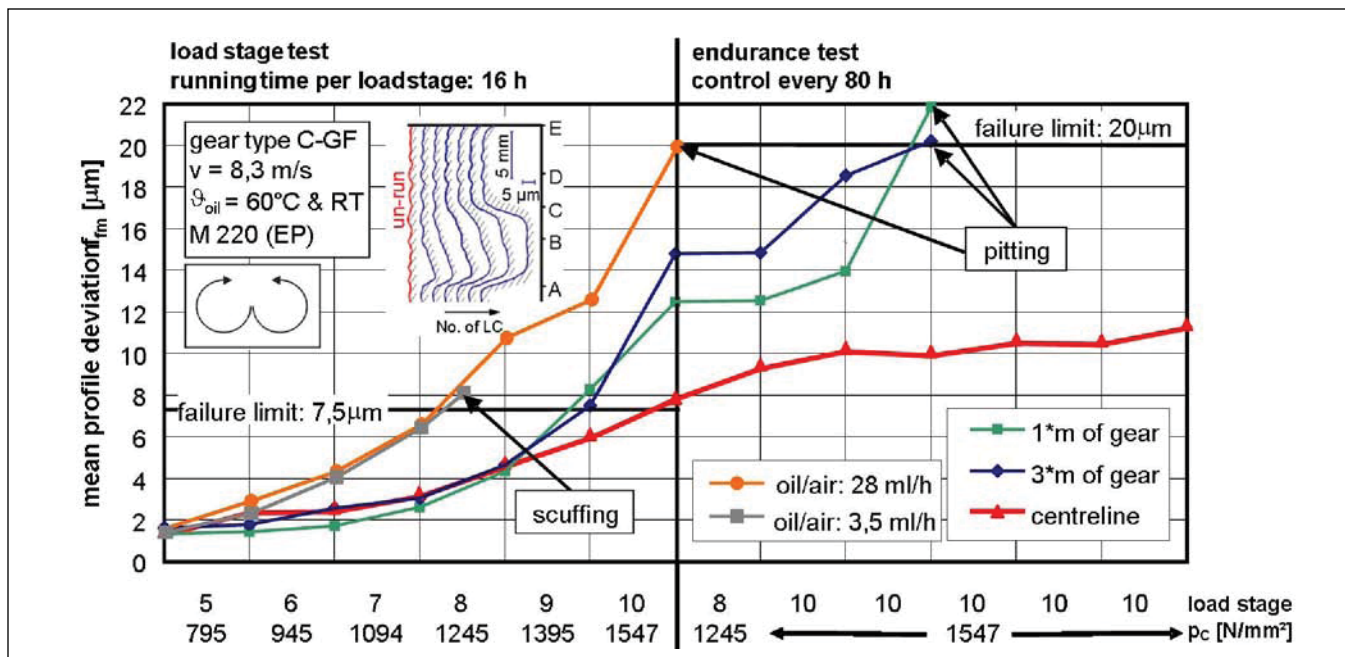

Figure 11—Mean profile deviation of pinion with minimized dip and oil/air lubrication (Ref. 12).



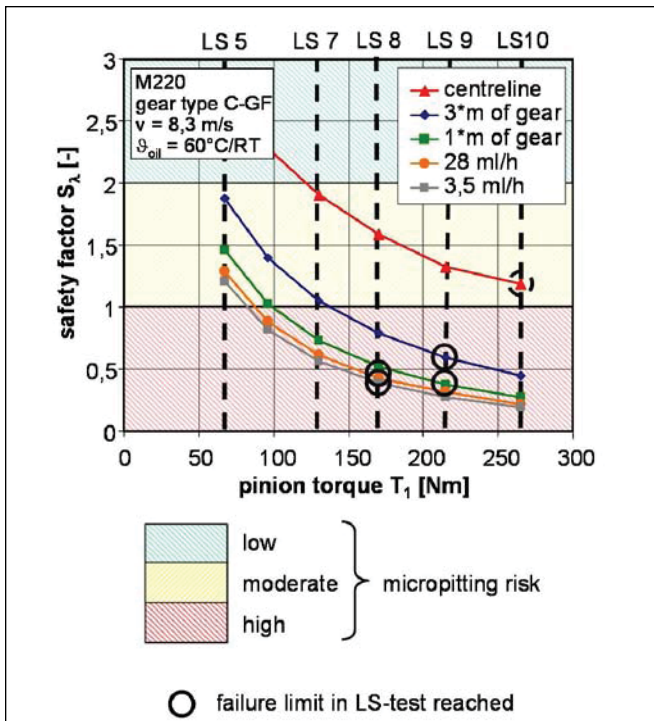

Figure 12—Calculated micropitting safety factor with minimized lubrication.

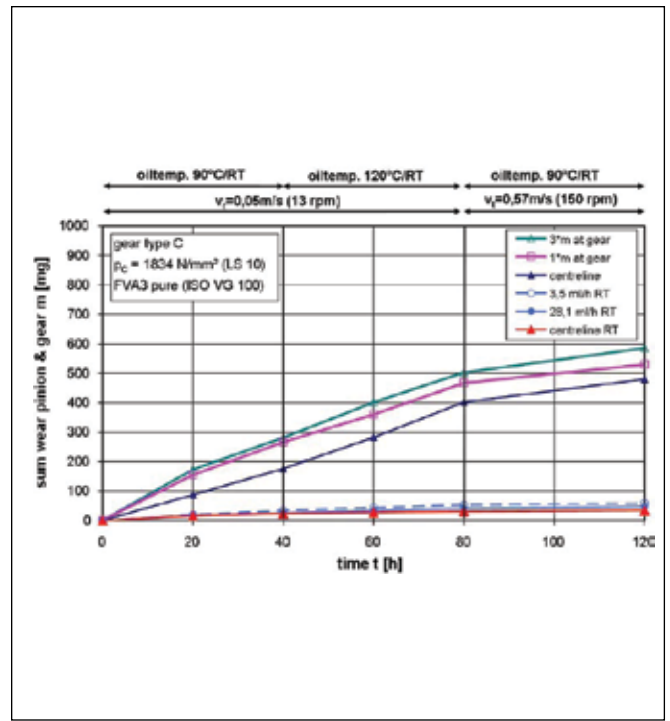

Figure 13—Wear of pinion with minimized dip and oil/air lubrication (Ref. 12).

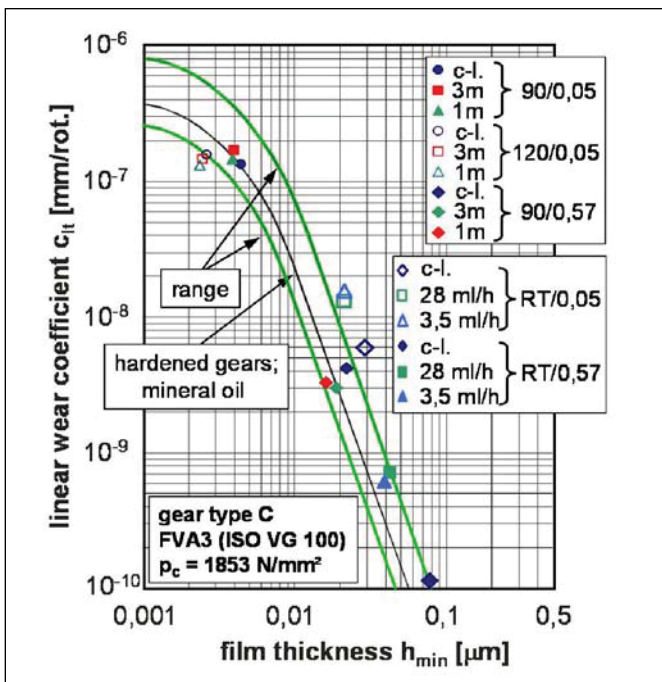

Figure 14—Plewe diagram with minimized dip and oil/air lubrication (Ref. 12).

Concerning pitting damage, test runs showed that by lowering the oil level the load cycles without pitting damage decreased by approximately 50% up to 75% for minimized lubrication, compared to the results with rich lubrication conditions. The allowable contact stress is clearly reduced (up to 30%) by minimized lubrication. High temperatures may result in a reduced material strength due to tempering, and a low oil viscosity results in a low oil film thickness. The common pitting load carrying capacity calculation algorithms according to DIN/ISO are only valid for moderate oil temperatures and rich lubrication conditions. An advanced calculation al-

gorithm for pitting load carrying capacity calculation at high gear bulk temperatures (valid for high oil temperatures as well as for minimized lubrication) is therefore proposed.

The micropitting risk is clearly increased by insufficient cooling of the gears when operating at low oil levels and low oil quantities.

Slow-speed wear is almost unaffected by minimized lubrication in the tests described.

Nevertheless, minimized lubrication is often used nowadays due to the reduced power losses and therefore higher gear efficiency which results, e.g., in a reduced fuel consumption in automotive applications. Knowing the limitations for reducing the oil quantity in transmissions enables the design engineer to build small, lightweight and efficient powertrains in order to comply with the demanding environmental, technical and financial requirements. ⚙️

## References

1. Bayerdörfer I., K. Michaelis, B.-R. Höhn and H. Winter. "Method to Assess the Wear Characteristics of Lubricants," FZG Test Method C/0, 05/90: 120/12, DGMK Information Sheet, Project No. 377, November, 1996.
2. DIN 3990, Teil 1 bis 5. *Tragfähigkeitsberechnung von Stirnrädern*, Beuth-Verlag, Berlin, 1987.
3. DIN ISO 14635-1. *Gears—FZG Test Procedure—Part 1: FZG Test Method A/8, 3/90 for Relative Load Carrying Capacity of Oils*, ISO, 2000.
4. Emmert S., G. Schönnenbeck, P. Oster and H. Rettig. "Testverfahren zur Untersuchung des Schmierstoffeinflusses auf die Entstehung von Grauflecken bei Zahnrädern," FVA Informationsblatt No. 54/I-IV, July, 1993.5.
5. ISO 14635, Part 1. *Gears—FZG Test Procedures—Part 1:*

continued

FZG Test Method A/8, 3/90 for Relative Scuffing Load-Carrying Capacity of Oils, 2000.

6. ISO 6336 1-6. *Calculation of Load Capacity of Spur and Helical Gears*, ISO, 2006.

7. ISO/TR 13989-2. *Calculation of Scuffing Load Capacity of Cylindrical, Bevel and Hypoid Gears—Integral Temperature Method*. ISO 2000 ISO 6336 1-6. *Calculation of Load Capacity of Spur and Helical Gears*, ISO, 2006.

8. Knauer, G. "Zur Grübchentragfähigkeit Einsatzgehärteter Zahnräder—Einfluß von Werkstoff, Schmierstoff und Betriebstemperatur," Diss., TU München, 1988.

9. Michaelis, K. "Die Integraltemperatur zur Beurteilung der Freßtragfähigkeit von Stirnradgetrieben," Diss., TU München, 1988.

10. Ohlendorf, H. "Verlustleistung und Erwärmung von Stirnrädern," Diss., TU München, 1958.

11. Oster, P. "Beanspruchung der Zahnflanken unter Bedingungen der Elasto-Hydrodynamik," Diss., TU München, 1982.

12. Otto, H.-P. "Flank Load Carrying Capacity and Power Loss Reduction by Minimized Lubrication." Diss., TU München, 2009.

13. Plewe, H.-J. "Untersuchungen zum Abriebverschleiß von Geschmierten, Lang-Samlaufenden Zahnradern," Diss., TU München, 1980.

14. Schedl, U., P. Oster, B.-R. Höhn and H. Winter. "Einfluss des Schmierstoffes auf die Grübchenlebensdauer einsatzgehärteter Zahnräder im Einstufen- und Lastkollektivversuch," FVA-Informationsblatt No. 2/IV, July, 1997.

15. Schrade, U. "Einfluß von Verzahnungsgeometrie und Betriebsbedingungen auf die Graufleckentragfähigkeit von Stirnrädern," Diss., TU München, 2000.

**Bernd-Robert Höhn** studied mechanical engineering at the Technical University Darmstadt (1965–1970) and served as an assistant lecturer (1970–1973) at the Institute for Machine Elements and Gears at the Technical University Darmstadt prior to becoming an assistant professor at the university (1973–1979). In 1978, he received his Ph.D. (Dr. Ing.) in mechanical engineering. In 1979 worked as a technical designer in the department for gear development of Audi. By 1982, he was head of the department for gear research and design for the automaker. In 1986 Audi named Höhn department head for both gear research and testing of automotive transmissions, until his departure in 1989 to become head of both the Institute of Machine Elements at the Technical University of Munich and of the Gear Research Centre (FZG). Höhn has served since 2004 as vice president for VDI for research and development and since 1996 has led the working groups 6 and 15 for ISO TC 60—calculation of gears.



**Klaus Michaelis** studied mechanical engineering at the Technical University Munich, receiving his degree (Dipl.-Ing) in 1969. Until 1970 he was a mechanical engineer at Linde, Lohhof, Germany, before working as a research assistant at the Institute for Machine Elements and Gear Research Centre (FZG) at the Technical University Munich (1970–1977). Since 1997 he has served as chief engineer and research group supervisor at FZG for gear load carrying capacity and tribology and experimental hydrodynamics. Michaelis received his Ph.D. in mechanical engineering in 1987.



**Hans-Philipp Otto** studied mechanical engineering at the Technical University Munich, receiving his Dipl.-Ing. degree in 2002. From 2003–2009 he was a research assistant at the Institute for Machine Elements and Gear Research Centre (FZG) at the Technical University Munich and in 2009 received his Ph.D. in mechanical engineering. Since that time Otto has worked as chief engineer and research group supervisor at FZG for gear load carrying capacity and tribology and experimental hydrodynamics, and as head of the FZG-Augsburg branch office—the technical application center of the FZG institute.

