

Gear Inspection and Chart Interpretation

by
Robert H. Moderow
ITW Illitron

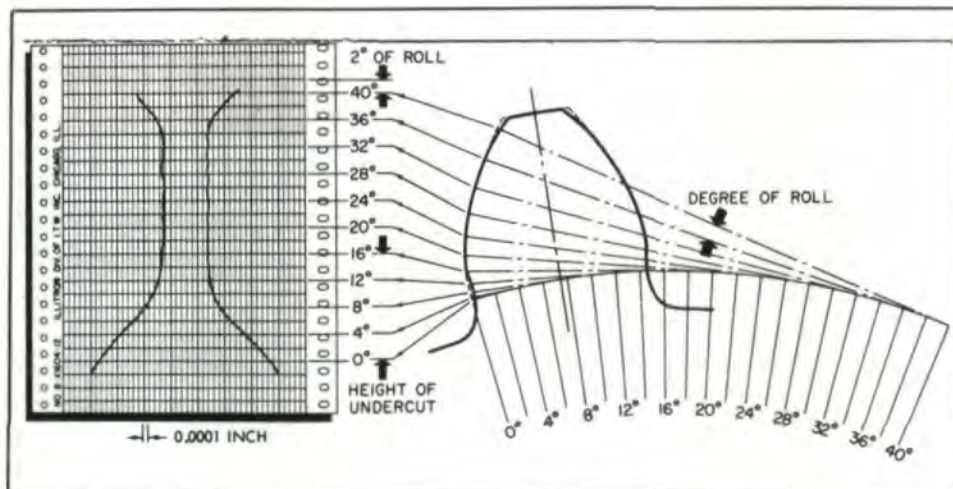

Fig. 1—Involute charts were made on a variable involute measuring instrument and charted

Much information has been written on gear inspection, analytical, functional, semiautomatic and automatic. In most cases, the charts, (if you are lucky enough to have recording equipment) have been explained. If there is an error in the gear, however, there is little information to tell you what the causes of the errors might be, or to offer some idea on how to correct them. This article attempts to offer some rudiments of "what to do next".

Figs. 1-3 show typical involute and lead charts, as well as the methods used to check runout and spacing on all the Analytical Gear Checks shown in this presentation. These charts can be used as a guide to test results of a normal, error-free gear.

AUTHOR:

ROBERT H. MODEROW is Training Manager for the Illitron Division of Illinois Tool Works, Chicago. He has over twenty-five years experience in gear tooling, gear design and inspection. Mr. Moderow has conducted gear seminars throughout the United States, Mexico and Canada and presently conducts four day gear seminars at Illitron dealing with the basics of gear theory, production and inspection. He is a member of the Society of Manufacturing Engineers (S.M.E.), American Society for Quality Control (A.S.Q.C.), and the A.G.M.A. and has spoken at many of their meetings.

A typical functional rolling chart is shown in Fig. 4. Runout and wobble can be readily found from this type of check, but involute, spacing and lead errors are difficult to find. The tooth-to-tooth composite variation is *not* the part's spacing errors, but is a composite of lead, involute and spacing errors, as well as nicks, etc. Wobble or face runout will show up as a single or double runout pattern. However, sometimes the pattern of the error in the functional check can lead you to the cause of the error. Fig. 5 could be of some help and is self-explanatory.

Runout

Fig. 6 shows all the analytical checks (lead, involute, spacing and runout) on a given gear, when the gear is mounted and inspected on the same center as it was machined. This particular gear is of very good quality, AGMA Class 12 or 13. Note that the gear was checked in three different positions, and all the checks are basically alike. In order to demonstrate the chart readings indicating runout, the gear was then mounted with runout and checked again. The results are shown in Fig. 7. All three checking positions gave basically the same checks, but the runout shows up, as it should, and this runout affects the tooth spacing and the involute. The lead is not affected, and would not be, unless the gear had lead and involute modifications, or was helical. (Note — runout does affect the gear's involute, but this error shows up more on small numbers of teeth. Also, the involute varies from plus to minus, depending on the tooth checked.)

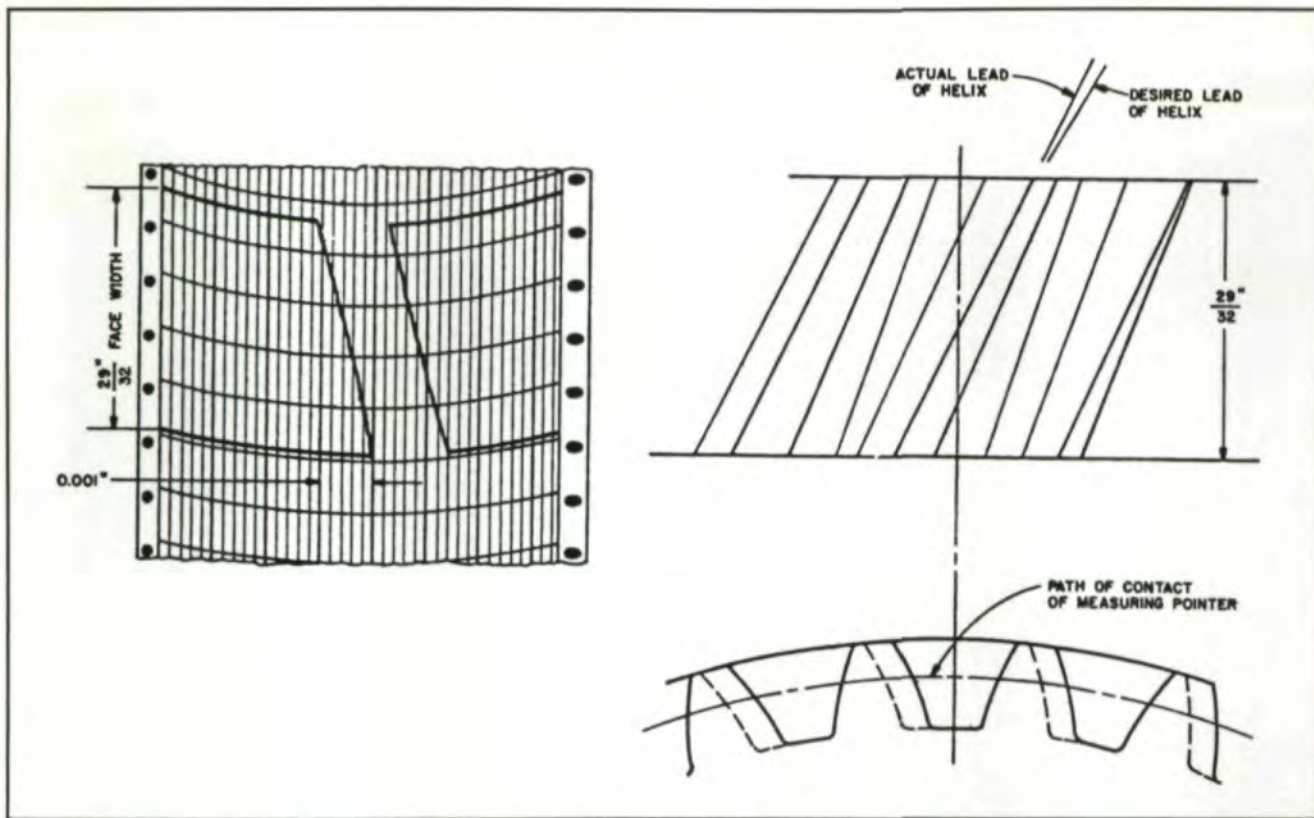

Fig. 2—Lead checks were made on a helical lead measuring instrument and charted.

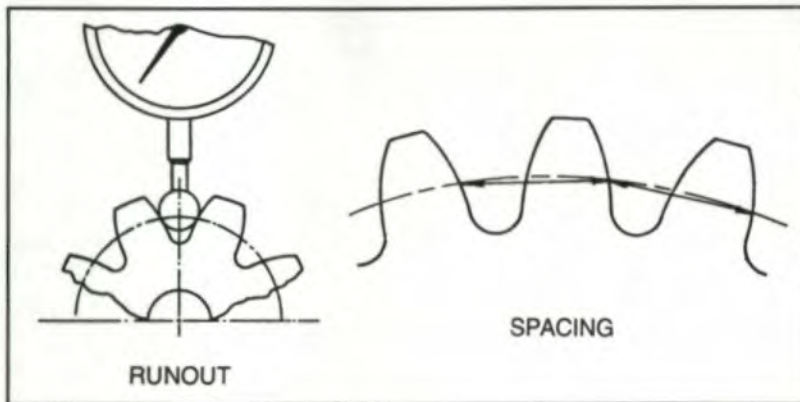

Fig. 3—(Left center) Runout was checked using a ball and an indicator and charted. Tooth spacing was checked using a fixed finger and an indicating finger and charted.

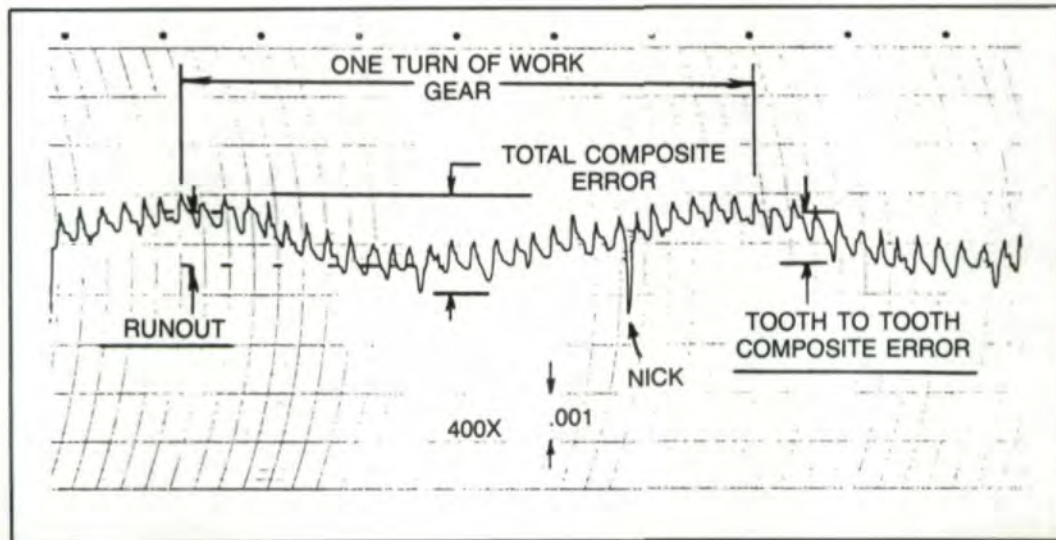

Fig. 4A—(Below) Typical chart obtained when using a "Gear Roller".



Fig. 4B—Gear Rolling instrument

Wobble (Face Runout)

Fig. 8 shows the gear mounted with wobble (face runout) and inspected again at the three positions. This time, none of three checking positions gave charts which were alike. This depends upon the location of the pivot point of the wobble. Notice that a gear with wobble shows errors in all analytical checks, but they are of different amounts depending upon

where the check is made relative to the wobble pivot point. Again, variation in the involute shows both plus and minus, but shows up more on small numbers of teeth, as in this test gear. The lead check shows variation (plus and minus depending on the tooth checked), and it is very typical of a gear with a wobble condition.

The charts which show variation (plus and minus, depending on the tooth checked) give you a very good indication of just why a gear should be checked by testing four teeth 90° apart. If this were not done, a bad gear could easily be passed as good by Inspection.

Studying these charts may help you to determine where to look when errors occur. For example, if a gear has runout, perhaps the work or inspection arbor is undersize, the blank hole is oversize, etc. If the gear has wobble, the mounting (machining or inspection), faces may not be square, work spacers not parallel (springing arbor), or the live center is running out. If you are stacking gears when cutting, and some gears check better than others, it may be that the good ones are at the center of pivot in a wobble condition. Also when stacking gears, if the blanks do not have parallel sides, one stack of gears may be entirely different from another. Subsequently, each load must be checked.

Fig. 5—Machine should be checked for accuracy at least twice a year by hobbing a gear with exactly the same number of teeth as the worm wheel on the machine. This should be done with a single thread AA hob very carefully spacing and runout and the resulting errors will indicate the area of the machine which should be repaired.

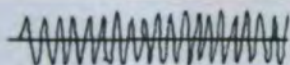

Uniform Error Tooth to Tooth

Hob not accurate enough.
Hob not running true.
(Try shifting hob $\frac{1}{3}$ to $\frac{1}{2}$ pitch).

Machine

Last output gears driving hob are worn or running out. Hob spindle end thrust bearings are loose.

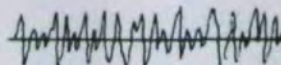

Non-Uniform Error Tooth to Tooth

Worm wheel on machine worn.
Change gear or gears have excessive error.

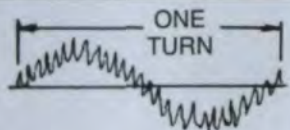

Uniform P.D. Runout Error

Gear blank running out or has wobble. Worm wheel worn or running out. (Check arbor for deflection when arbor nut is tightened).

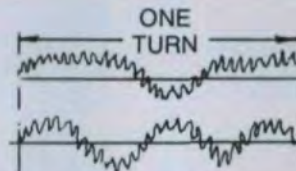

Non-Uniform P.D. Runout Error

Worn worm wheel or change gears.

Fig. 6—Analytical inspection charts of a gear properly mounted, both at the time of machining and at the time of inspecting. Note that the charts are basically alike, no matter where the gear is checked.

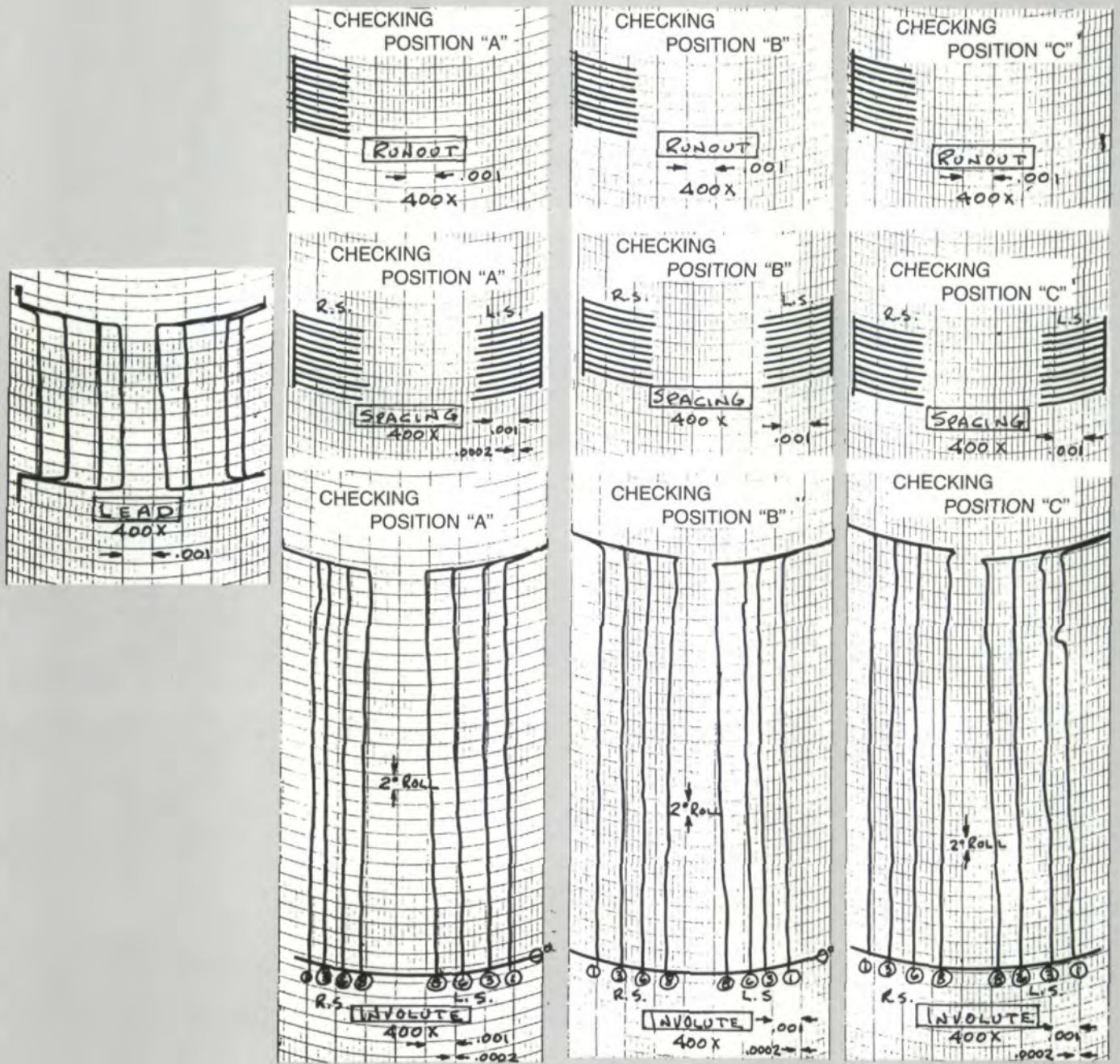
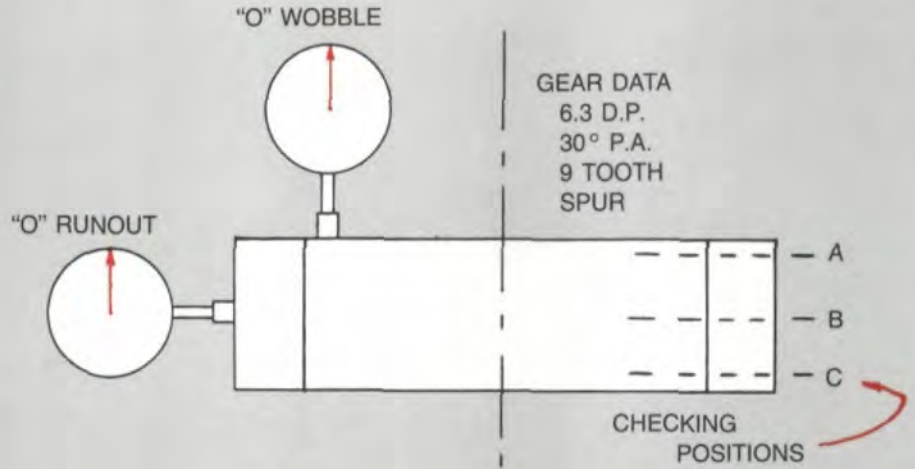

Fig. 7—Analytical inspection charts showing the effects of runout, either at the time of machining or at the time of inspection, on the various gear elements. Note that the charts are basically alike, no matter where the gear is checked.

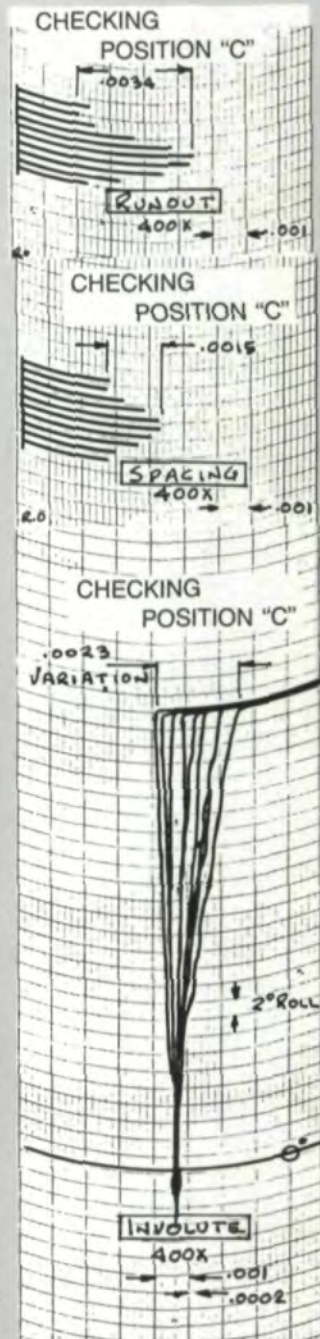
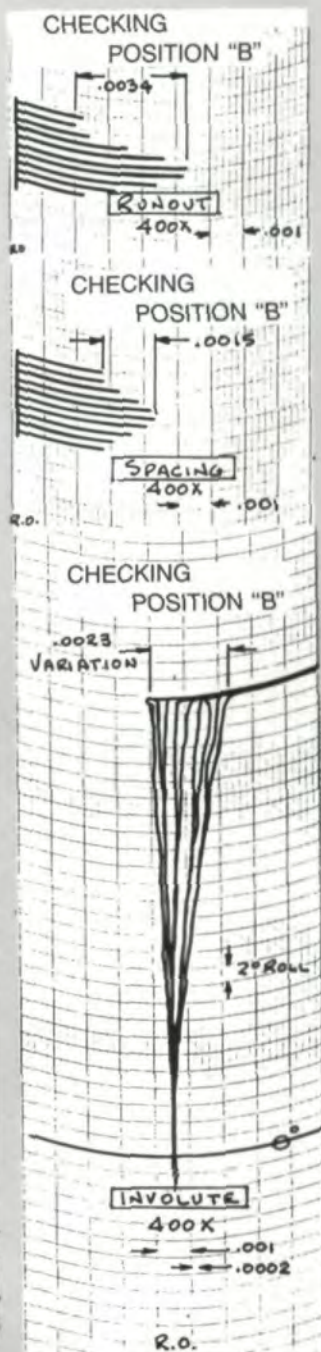
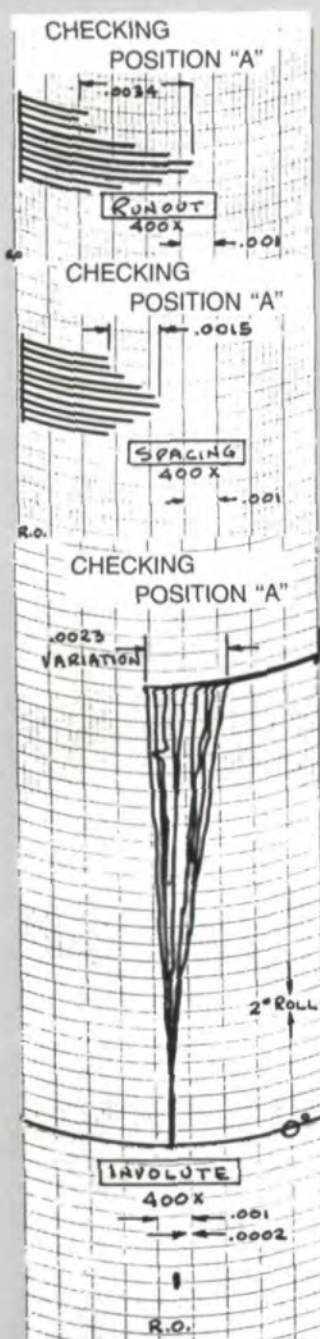
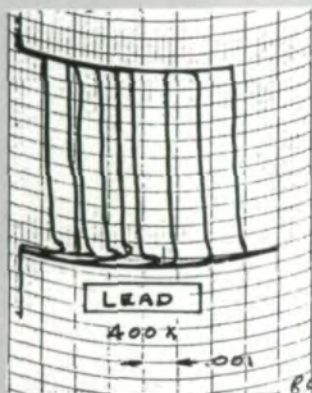
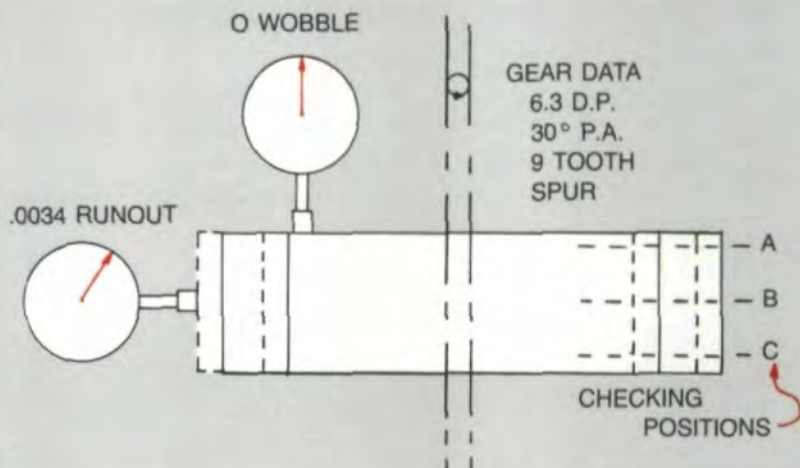
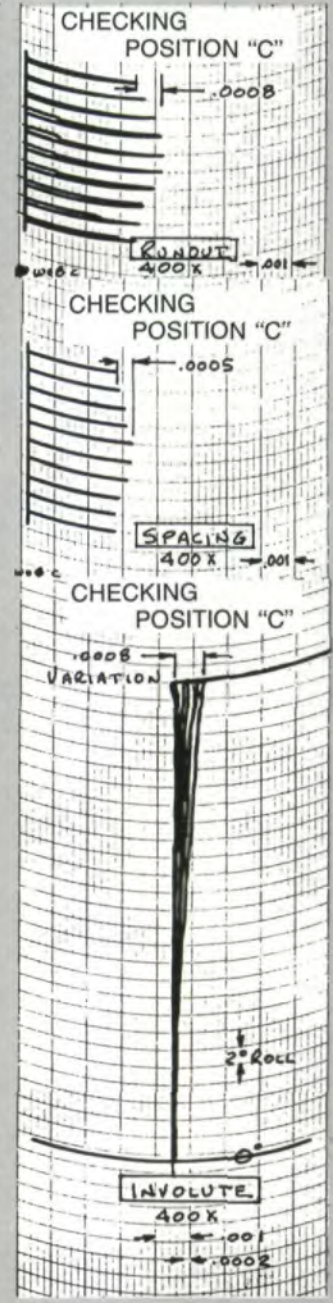
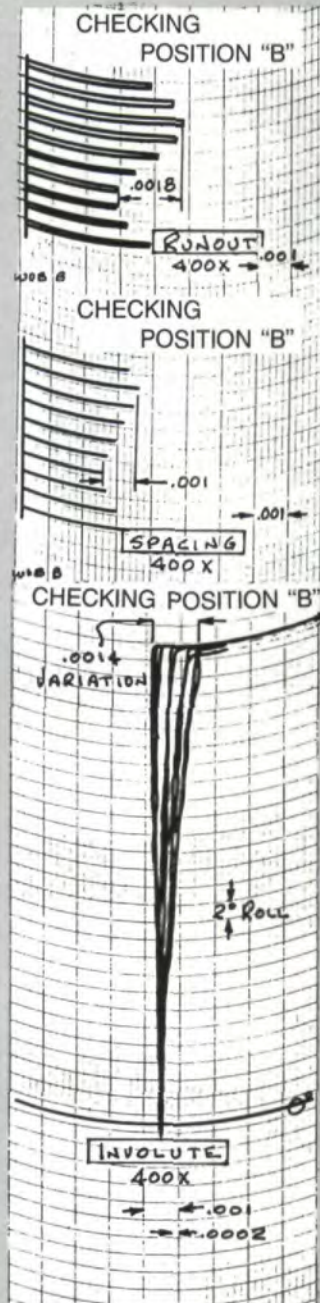
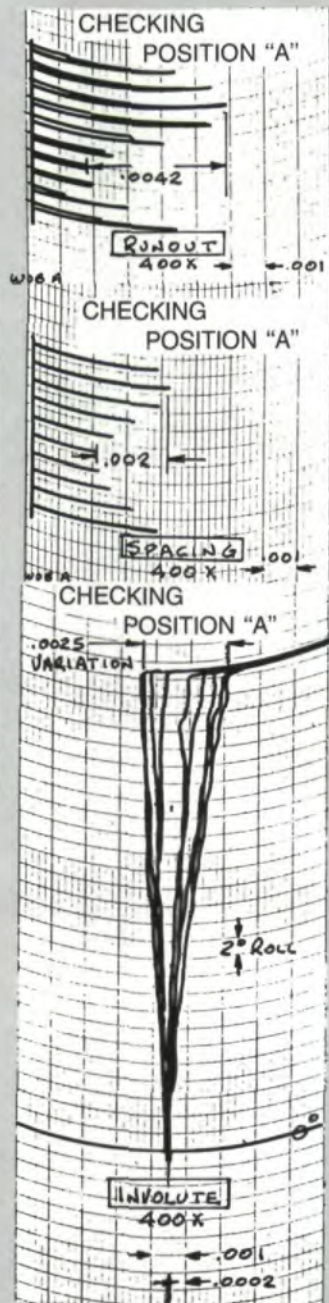
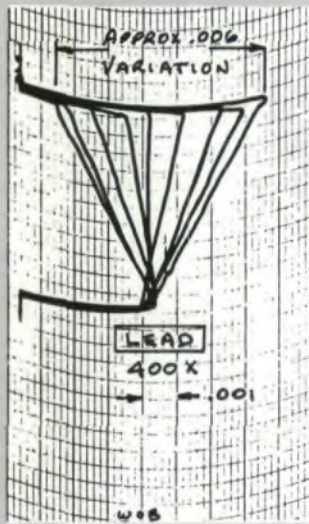
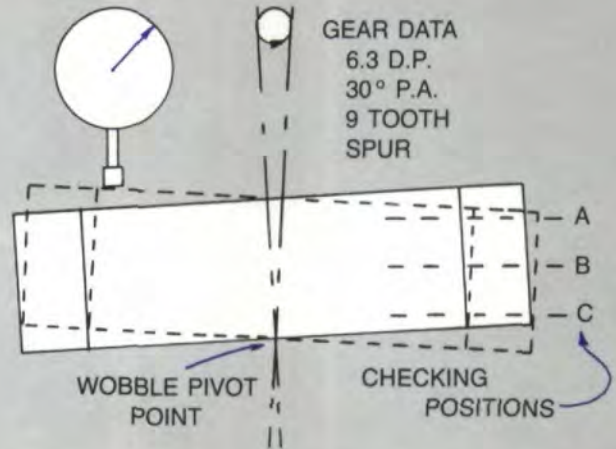

Fig. 8 - Analytical inspection charts, showing the effects of wobble, either at the time of machining or the time of inspection on the various gear elements. Note that the charts are different, depending on the position of the check, relative to the pivot point of the wobble.

.005 WOBBLE



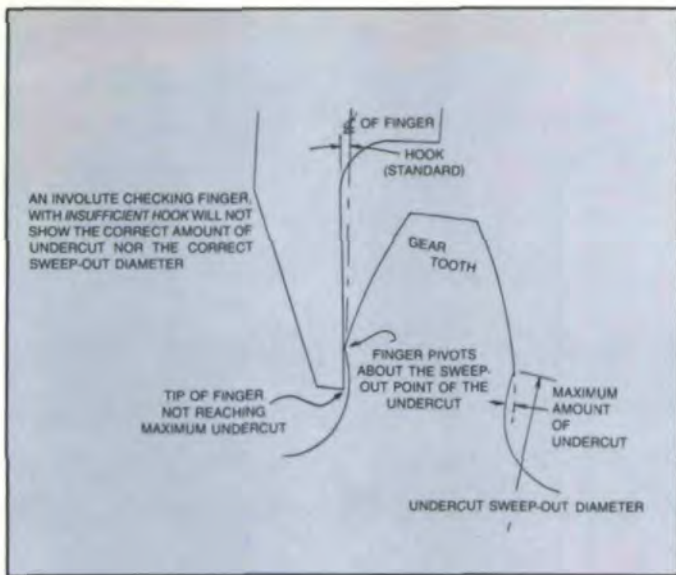

Fig. 9A

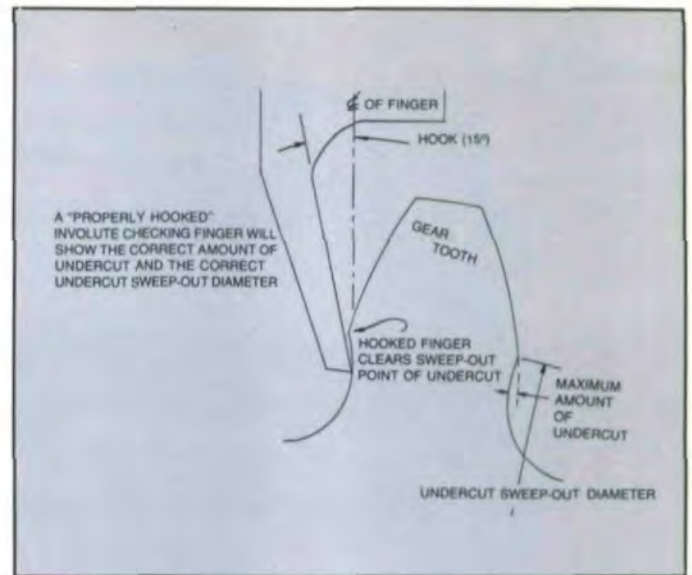

Fig. 9B

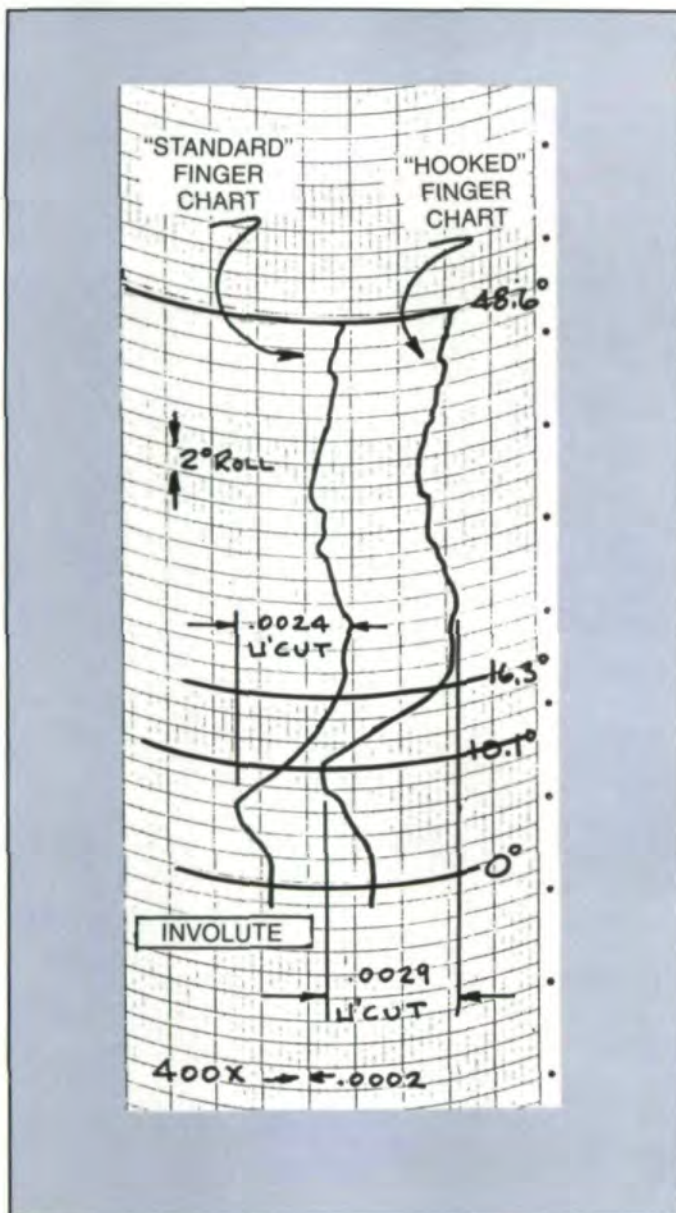

Fig. 9C

Checking Undercut Gears

Fig. 9 illustrates a very common problem in checking the involute on gears that have undercut, such as pre-shaved, pre-rolled, pre-grind. In all of the previous gear types, the position and the amount of undercut is very important. Not only should the undercut be positioned properly in the flank of the gear tooth, to assure true involute to the last point of contact of the mating gear, but the amount must also be correct to avoid the possibility of shaving or grinding nicks or steps in the fillet area. You are getting an incorrect picture of the gear tooth's undercut, if the involute checking finger is not "hooked" sufficiently; the pictures and the resultant charts are self-explanatory. Fig. 9B shows a 15° hooked finger, would probably be necessary only for gears with a large amount of undercut, such as pre-grind. In most cases, a 10° hook would be sufficient.

CORRECTION

John C. Leming, V.P. Engineering Arrow Gear Co., Downers Grove, IL was not listed as co-author of "GEAR GRINDING TECHNIQUES PARALLEL AXES GEARS", which appeared in the March/April 1985 issue of GEAR TECHNOLOGY. Illustrations for that article were provided by the courtesy of: American Pfauter Company, Kapp and Company, U.S. Representatives, Elk Grove Village, Illinois; Barber Colman Company, Okamoto Company, U.S. Representatives; BHS Hofer, Clinton, New Jersey, Maag Gear-Wheel Company Ltd., Zurich, Switzerland; National Broach & Machine Division, Clemens, Michigan; Reishauer Corporation, Elgin, Illinois.

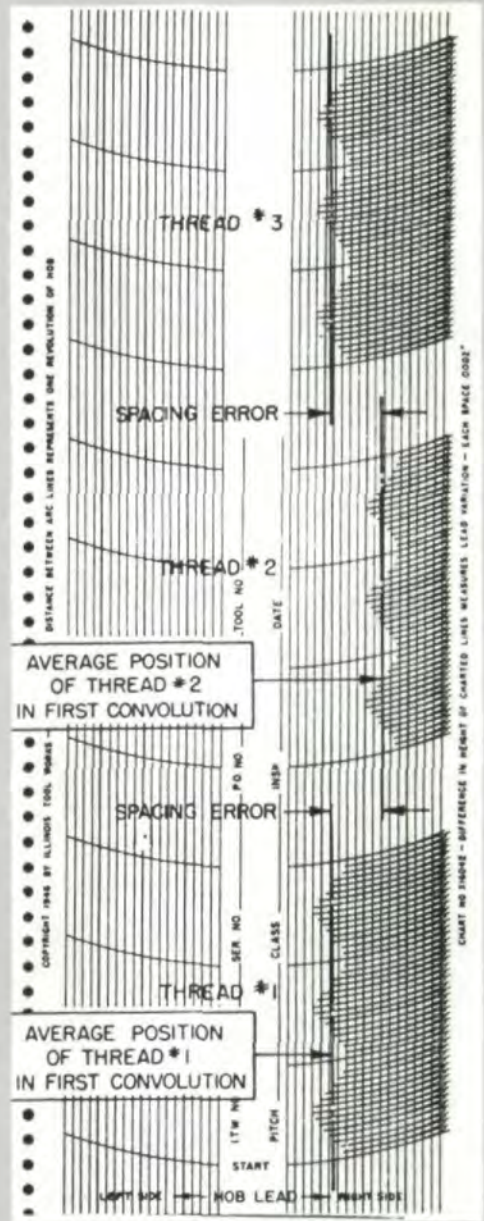
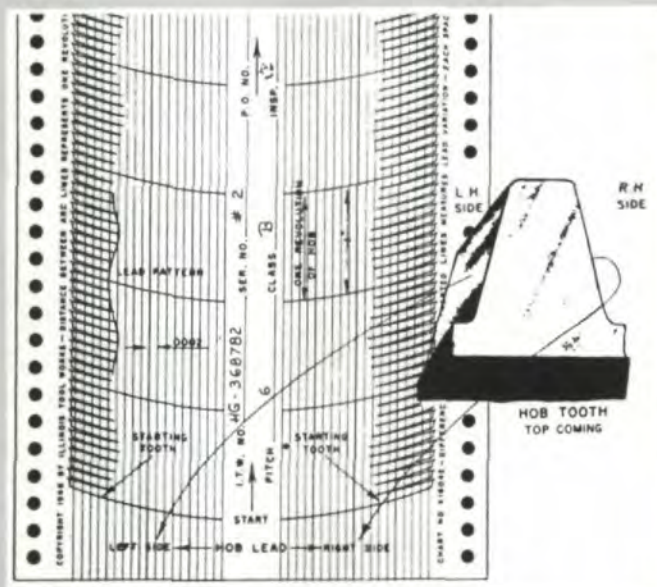
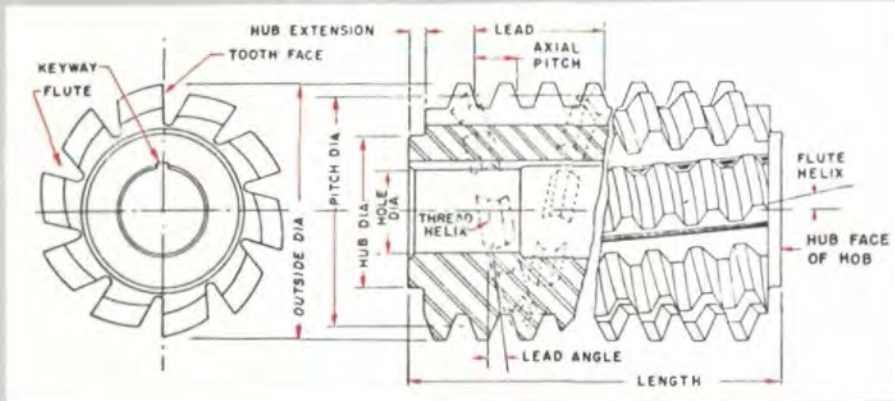

Fig. 10

Hob Errors

The lead chart of a hob is an indication of the accuracy of the helical path of a hob's teeth. A single thread hob can affect only the profile of the gear tooth. If the hob has a good lead, the gear's profile can be good. If the lead is bad, the profile will most likely be bad. Fig. 10 shows a hob lead chart.

The charts shown in Fig. 11 illustrate the problems which result when mount-

ing a hob incorrectly. Number 1 is a very good hob mounted properly and the resulting gear involute produced. Numbers 2-4 show the same hob mounted incorrectly, with the resulting effect on the hob's lead chart (checked as mounted) and on the involute form produced on the gear.

As a hob cuts a gear, the top of the gear's involute form is finish cut at a different point in time than the bottom.

Because of this, when hobbing with heavy feed rates, the entire involute form will tend to drift. (Fig. 12) The resulting involute checks may vary on the same tooth across the face of the gear, depending upon just where the involute checking finger is positioned. This is not to say there is an error here, but just to explain why two involute checks may vary when checking the same tooth.

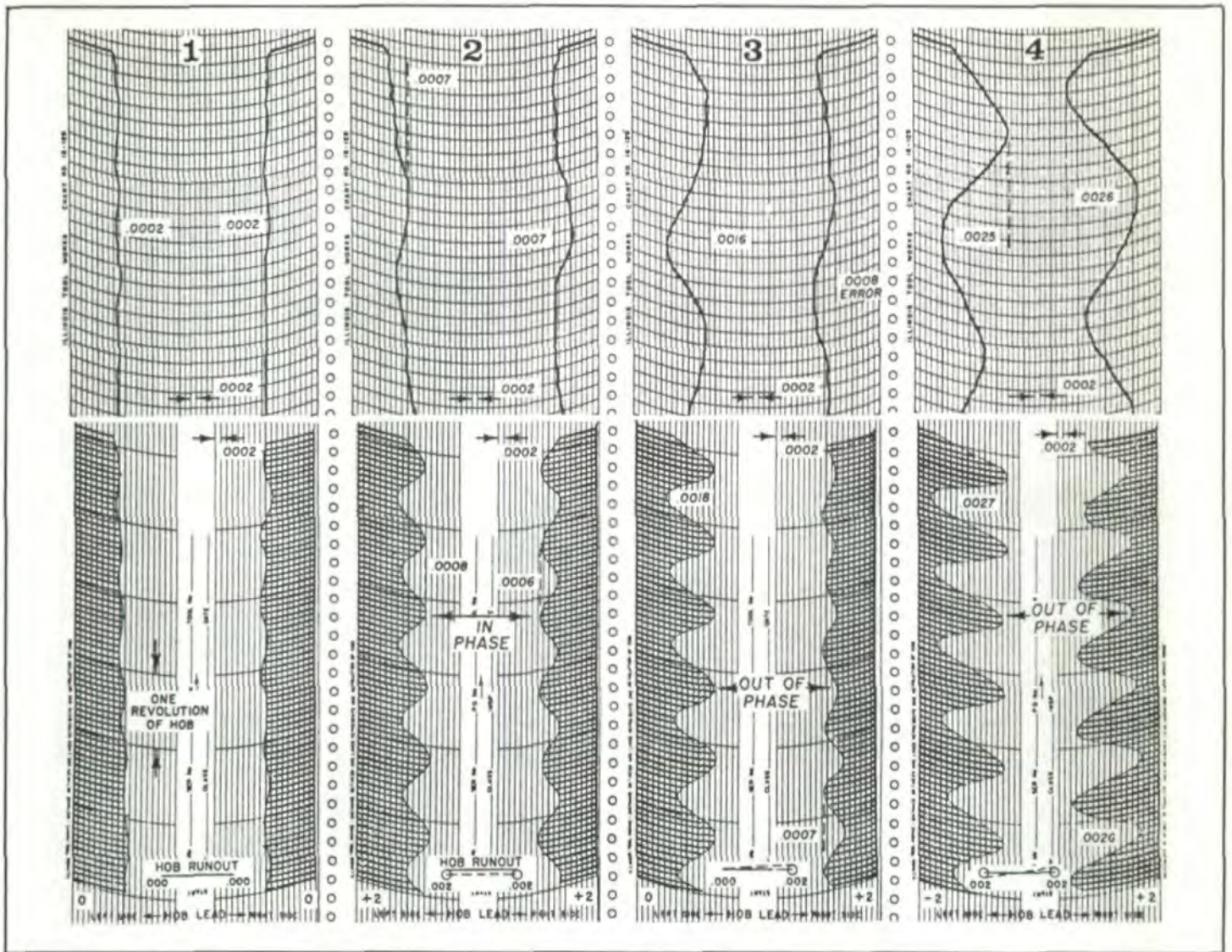

Fig. 11—These charts show the types of weave produced by various conditions of runout and the amount of error each type produces in a gear tooth.

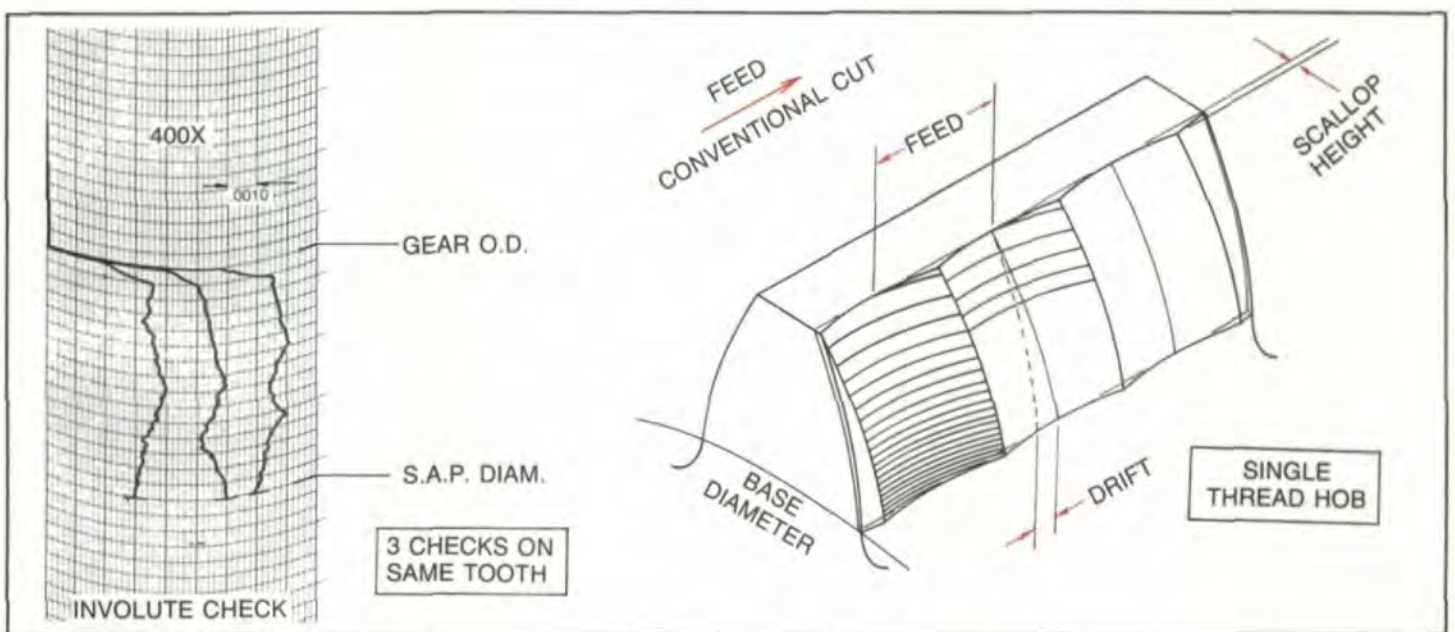
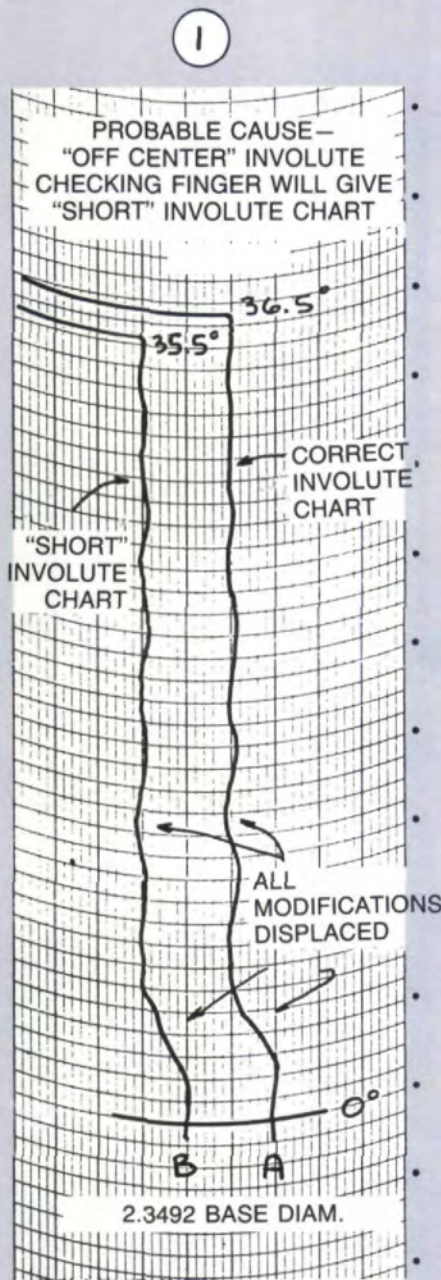
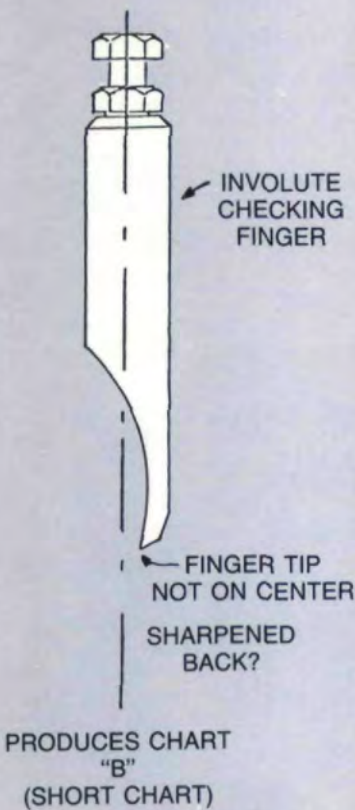
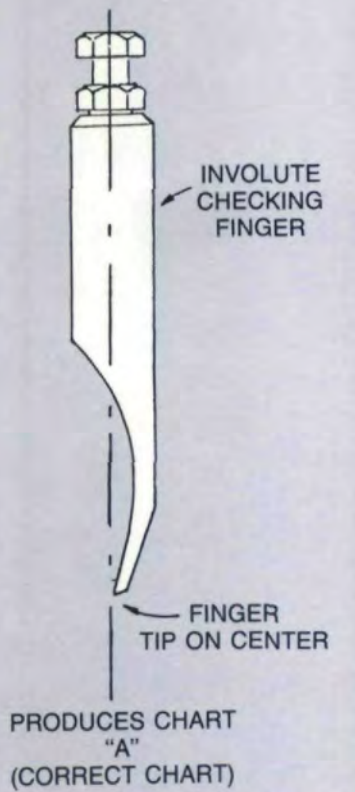

Fig. 12—Involute checks on the same tooth vary if the gear is hobbled with a heavy feed rate, the involute drifts and one check may high point of feed scallop at pitch line, and another check may have high point at another place along the involute.



②

PROBABLE CAUSE—
INVOLUTE CHECKING MACHINE
GENERATING SLIDE OR
FINGER HOLDER NOT ON CENTER

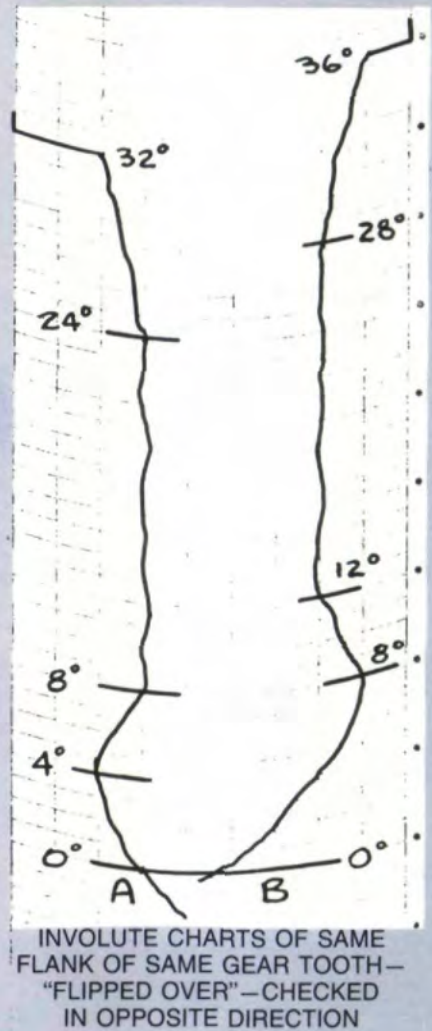
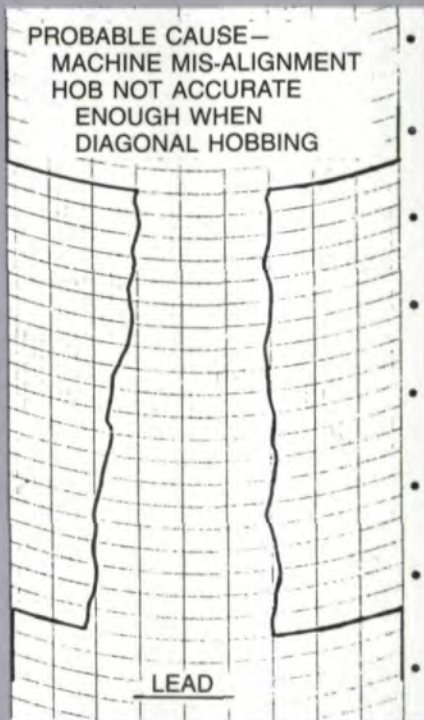
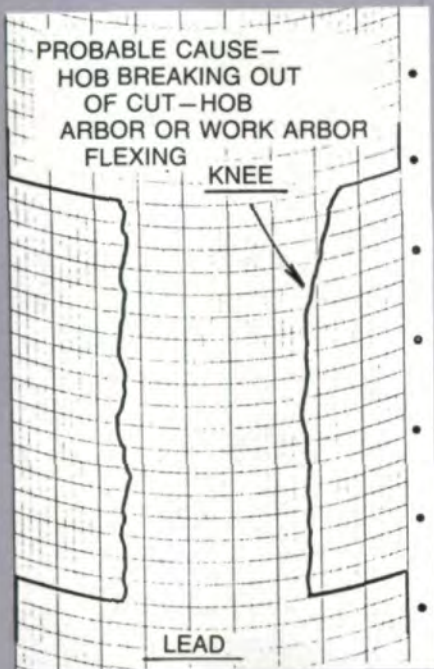
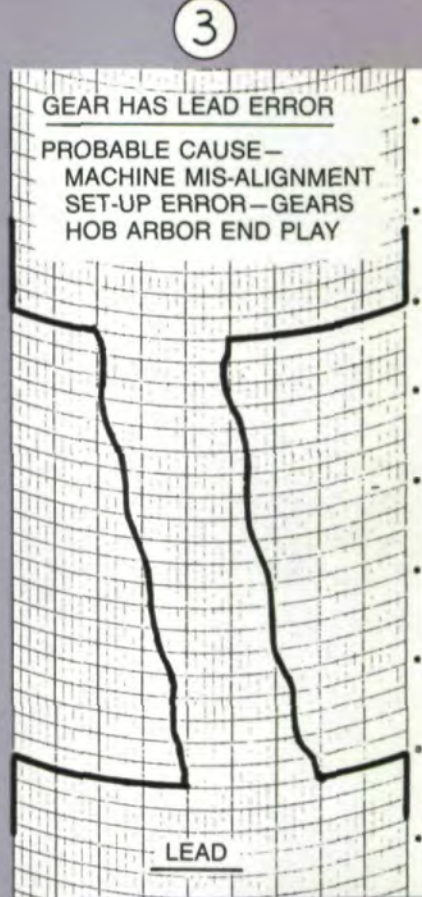
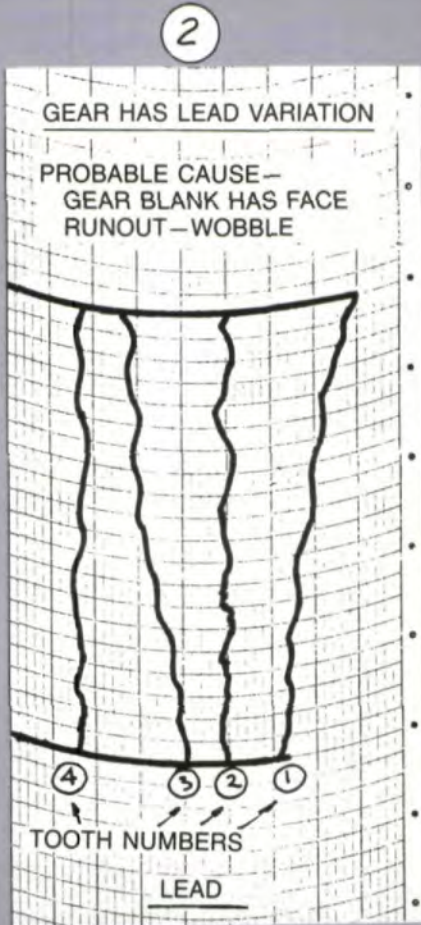
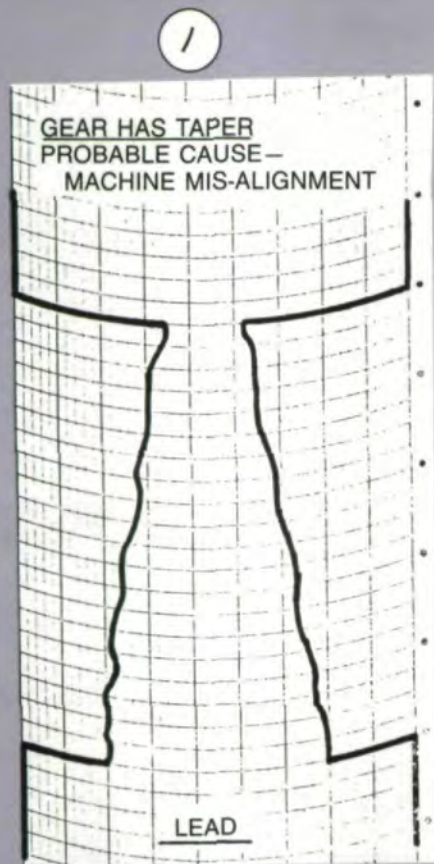

Fig. 13



4

5

Fig. 14

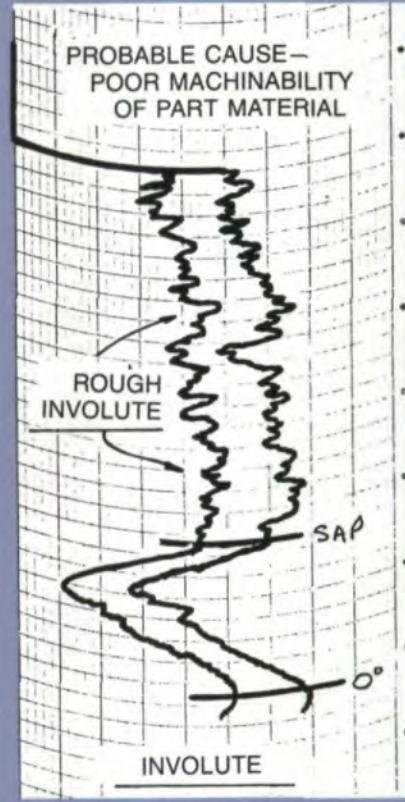
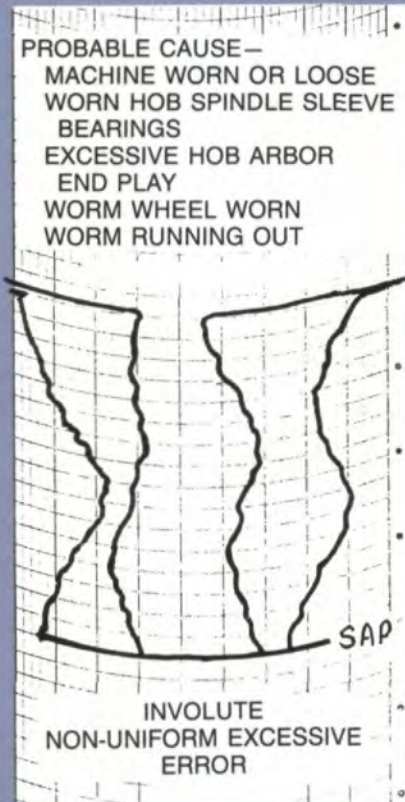
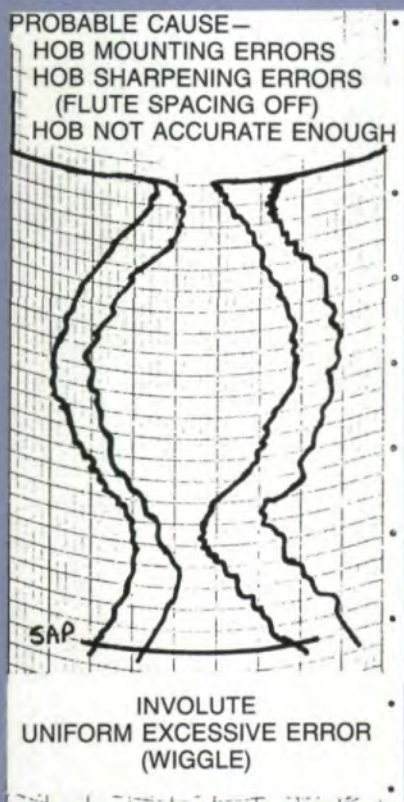
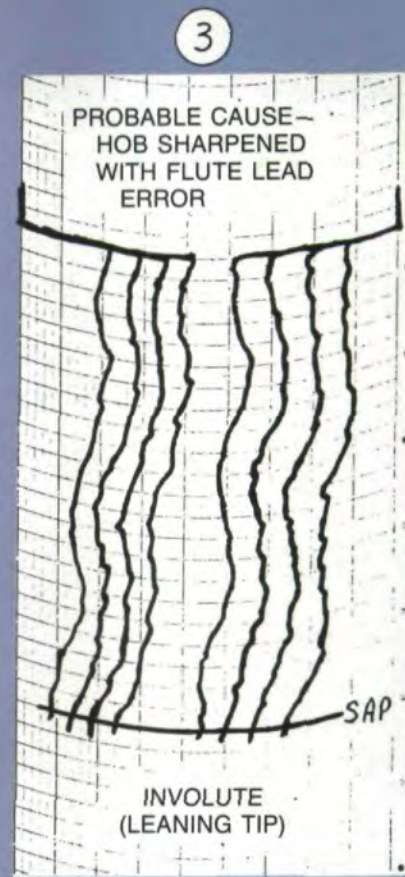
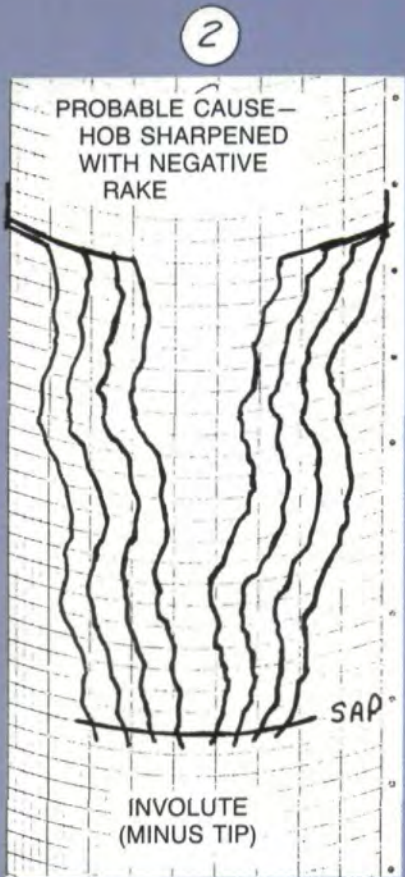
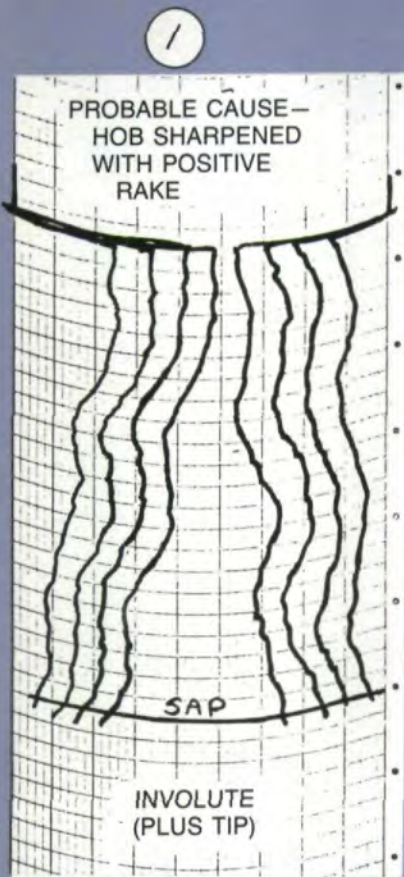

4

5

6

Fig. 15

HOB MOUNTING ERRORS MULTIPLE THREAD

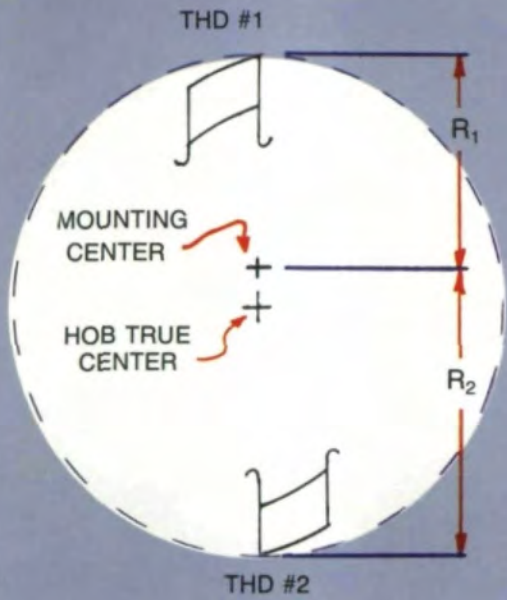

2 THREAD HOB

R_2 IS LARGER THAN R_1 , AND WHEN CUTTING EVEN NUMBERS OF TEETH WILL CUT WIDER AND DEEPER TOOTH SPACES

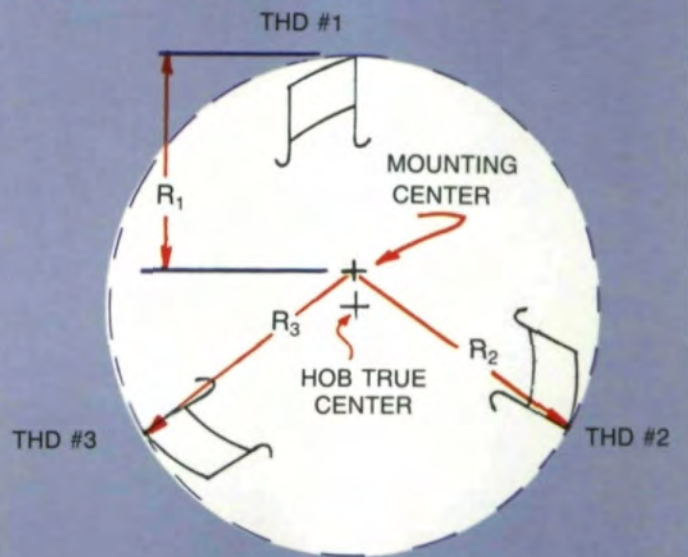

3 THREAD HOB

R_2 AND R_3 ARE LARGER THAN R_1 , AND WHEN CUTTING A NUMBER OF TEETH EVENLY DIVISIBLE BY 3, WILL CUT WIDER AND DEEPER TOOTH SPACES

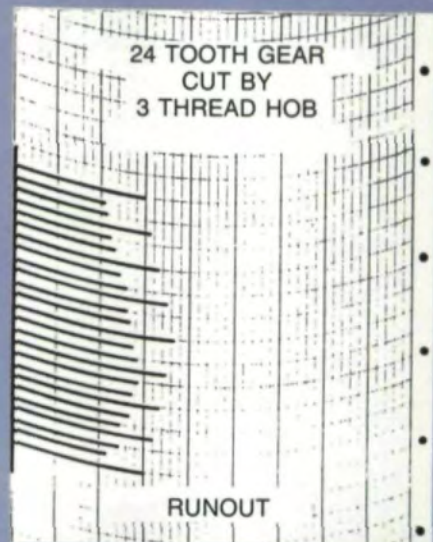
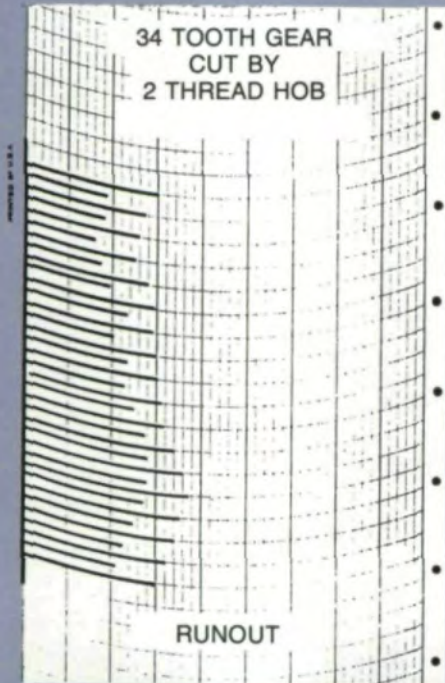

Fig. 16

Fig. 17 - Possible cause:

- 1) Hob hubs running out—out of phase (high with low)
- 2) Hob has weave error in lead, out of phase, from thread to thread

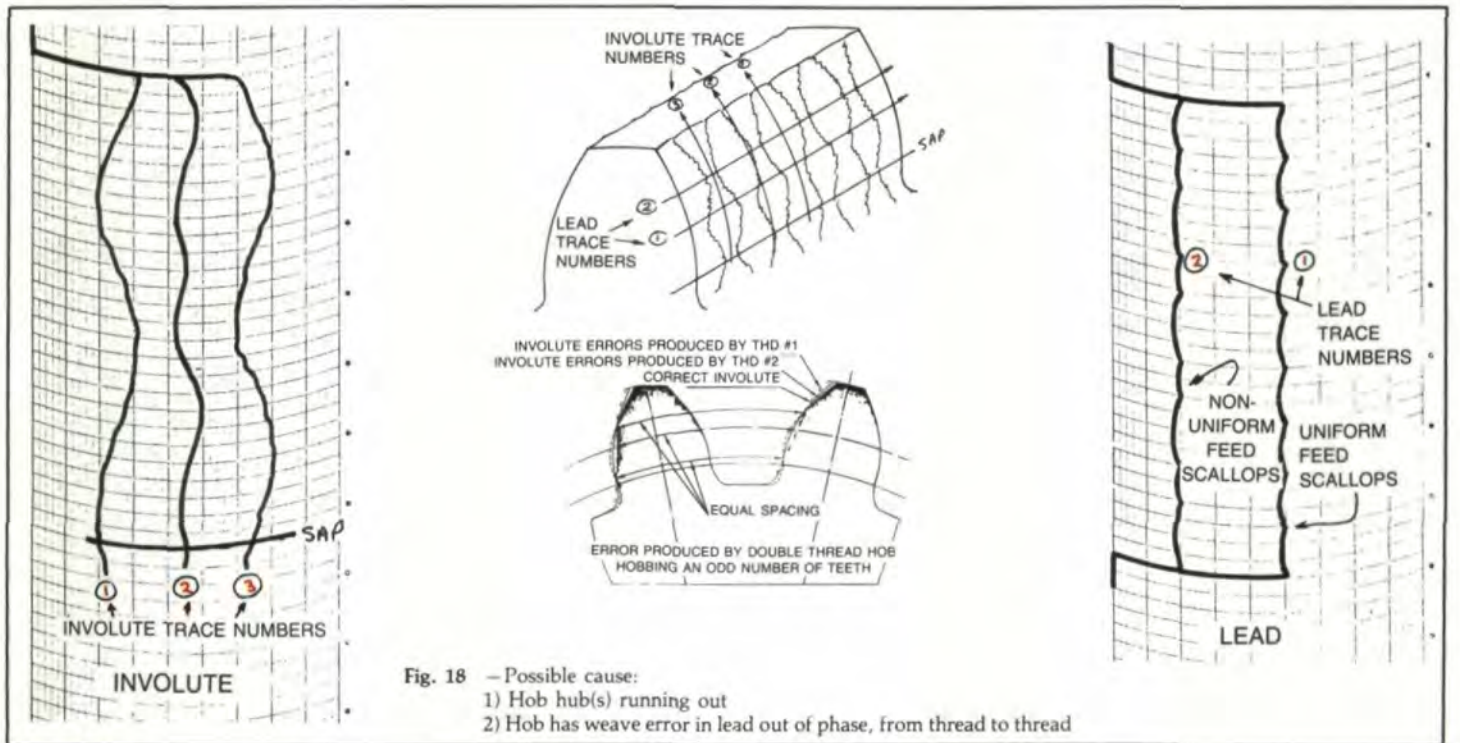
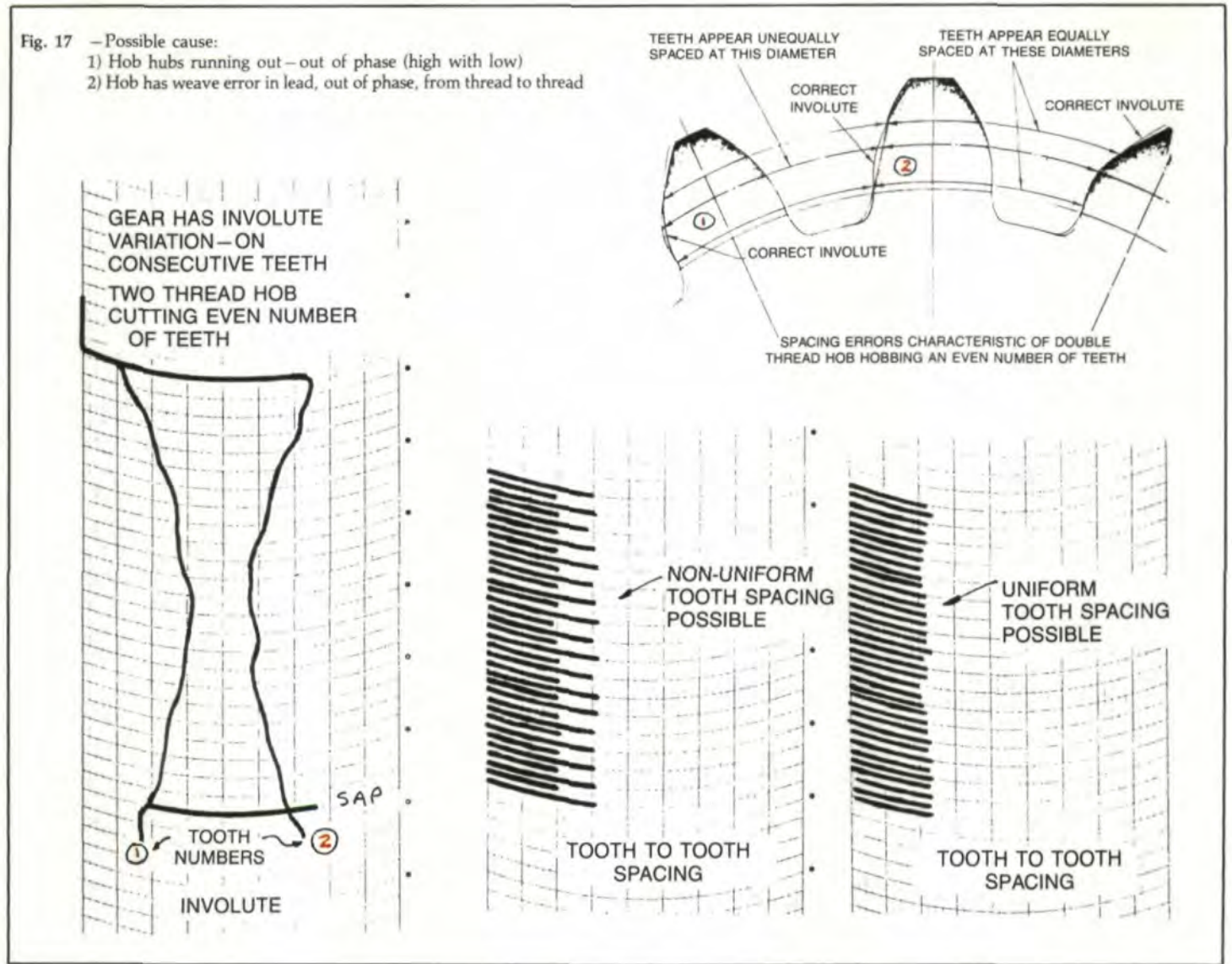
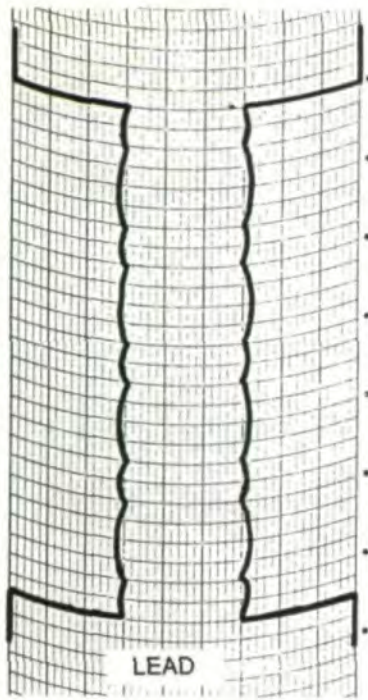

Fig. 18 - Possible cause:

- 1) Hob hub(s) running out
- 2) Hob has weave error in lead out of phase, from thread to thread

ALTERNATELY WIDE AND NARROW FEED SCALLOPS



- POSSIBLE CAUSE—
- 1) HOB HUB(S) RUNNING OUT
 - 2) HOB HAS THREAD TO THREAD SPACING ERRORS

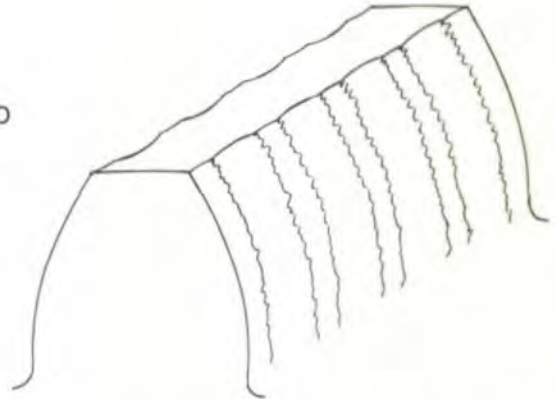

DOUBLE THREAD HOB CUTTING
ODD NUMBER OF TEETH

Fig. 19

FEED SCALLOPS VARY IN PATTERNS OF THREE

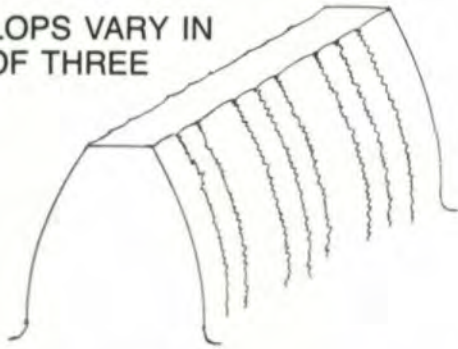

TRIPLE THREAD HOB CUTTING NUMBER
OF TEETH NOT DIVISIBLE BY THREE
(HUNTING TOOTH)

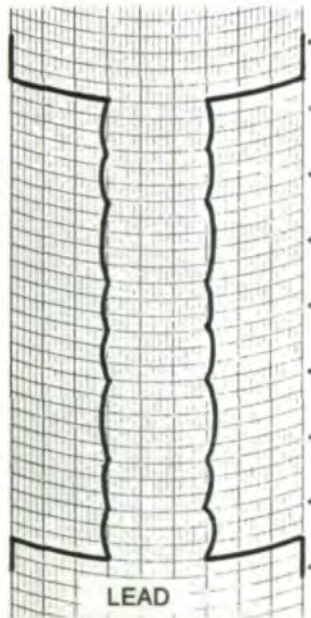

- POSSIBLE CAUSE—
- 1) HOB HUBS RUNNING OUT—IN PHASE
(HIGH WITH HIGH)
 - 2) HOB HAS THREAD TO THREAD
SPACING ERRORS

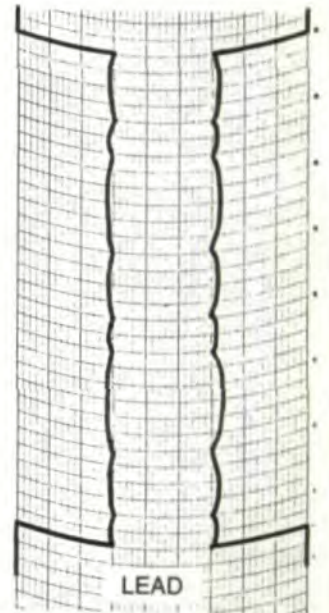

Fig. 20

Inspection Equipment Errors

Fig. 13 shows two involute charts which have errors resulting from inaccurate inspection equipment. Chart #1 (Fig. 13) shows actual charts of a gear having a 2.3492 base diameter. Chart "A" was made with a new involute finger which had its tip on center. Chart "B" was made with a hooked finger which was "sharpened back" and the finger tip was then off center by .022. This made a "short chart", being off one degree of roll. (Note that all modifications will also be displaced one degree of roll.) Chart #2 (Fig. 13) shows two charts again, "A" and "B", which are of the same flank of the same gear tooth, but turned end for end in the involute machine. When the charts do not come out identical as to the position of their modification relative to the degrees of roll, usually the machine is not centered properly. Most involute checking instruments are furnished with a centering gauge to check out this problem.

Lead Errors

Five lead charts with various errors have been grouped in Fig. 14. When dealing with lead errors, it is important to remember lead errors seldom, if ever, come from the cutting tool. They almost always come from machine misalignments, looseness, lack of rigidity, gear blank accuracy and mounting, etc. Chart #4, showing a lead error only on one side of the gear tooth near one end, usually occurs as the hob is breaking out of (or into) the cut. This is a result of machine or arbor deflections. This can be corrected by climb cutting, if the gear was cut by conventional cutting and vice versa. A more rigid setup of machine (such as larger diameter hob arbor) or lighter cuts may be in order. Chart #5 (Fig. 14) is a difficult problem, and is usually caused by machine misalignment, although, the hob could be at fault, if you are diagonal or oblique hobbing.

Involute Errors

Fig. 15 shows involute charts with various errors, all of which are self-explanatory. It is important to note, when using a single thread hob, if the involute error is uniform (essentially the same on all teeth), the error may be coming from the hob (accuracy, mounting, sharpening, etc.), but if the error is non-uniform, it is more likely to be coming from the machine.

Multithread Hobbing

Multithread hobbing has its own peculiar problems, somewhat similar to single thread hobbing, and yet quite different. Since more and more companies are going to multithread hobbing, it is important to cover some of these problems.

A drawing of a gear hob and the lead charts from both a single thread hob and a three-thread hob were shown in Fig. 10. The three-thread hob lead chart shows a thread-to-thread spacing error between thread #2 and thread #3. It is generally shown that if a gear with a number of teeth evenly divisible by the number of hob threads (3) were cut by this hob, the gear cut would have a spacing error approximately equal to the error in the hob. However, assuming a 3-thread hob had little or no spacing errors, because just a section of the hob teeth (one axial pitch or so) is finish cutting the gear, hob mounting would be very important. If not correctly mounted, it would have thick and thin teeth, spacing errors and runouts, which show up in patterns equal to the number of threads in the hob. Fig. 16 shows the condition and the result on the gear. In each case shown, the effective radius to thread #1 (R1) is shorter than the effective radius to the other thread(s), and R1 will cut shallower tooth spaces than the other thread(s). On the examples shown, the dimension over wires on the gears would be considerably different, from one tooth space to the next.

Again, when cutting a number of teeth in a gear which is divisible by the number of hob threads (non-hunting tooth), each tooth is cut by one given thread on the hob. Therefore, each thread will produce a given involute, and involutes may vary from tooth to tooth. This is shown in Fig. 17. In this case, the gear's tooth spacing may or may not vary, depending upon the position of the spacing check along the involute.

The usual "rule of thumb" in multithread hobbing is to cut a number of teeth not divisible by the number of threads (hunting tooth). This is definitely advisable, as many of the errors may tend to "cancel out", as each thread of the hob eventually passes through all of the gear's tooth spaces. This would work effectively if the hob was not fed through

the part. However, with today's high feed rates, much of this "canceling effect" does not occur, and the errors are produced in sections along the gear's face width, in each individual feed scallop. Many times, feed scallops can tell a story.

Fig. 18 illustrates a feed scallop pattern which varies in width along the involute. Since each feed scallop is produced by a

FEED SCALLOPS NOT SAME ON BOTH SIDES ON TEETH

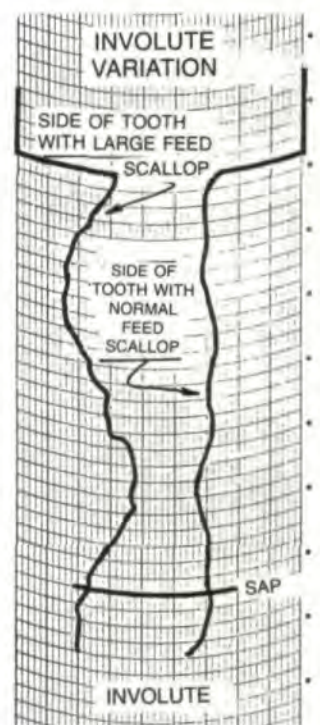
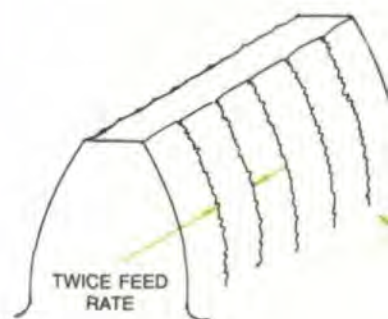

different hob thread, the involutes can vary by as many threads as there are in the hob and more. At the junction of two adjacent feed scallops, there is an "overlapping" area where the "canceling effect" does occur and another involute variation results. This is shown by the involute checks (Fig. 18). Trace #1 and #3 result from different hob threads pro-

ducing that area (scallop) of the gear. Involute trace #2 is a combination of #1 and #3.

Figs. 19 & 20 show variations of feed scallops, in patterns relative to the number of threads in the hob.

Examples of feed scallops not being the same on both sides of the gear tooth or space are shown in Fig. 21. The "hunting

tooth ratio rule" was followed, but the hob was mounted with runout on one end, or had severe thread spacing on one flank. If the hob is running out on one end, the side of the gear tooth with the twice normal size feed scallop will also have severe involute error. The other side of the gear tooth will have a much better involute.

E-4 ON READER REPLY CARD

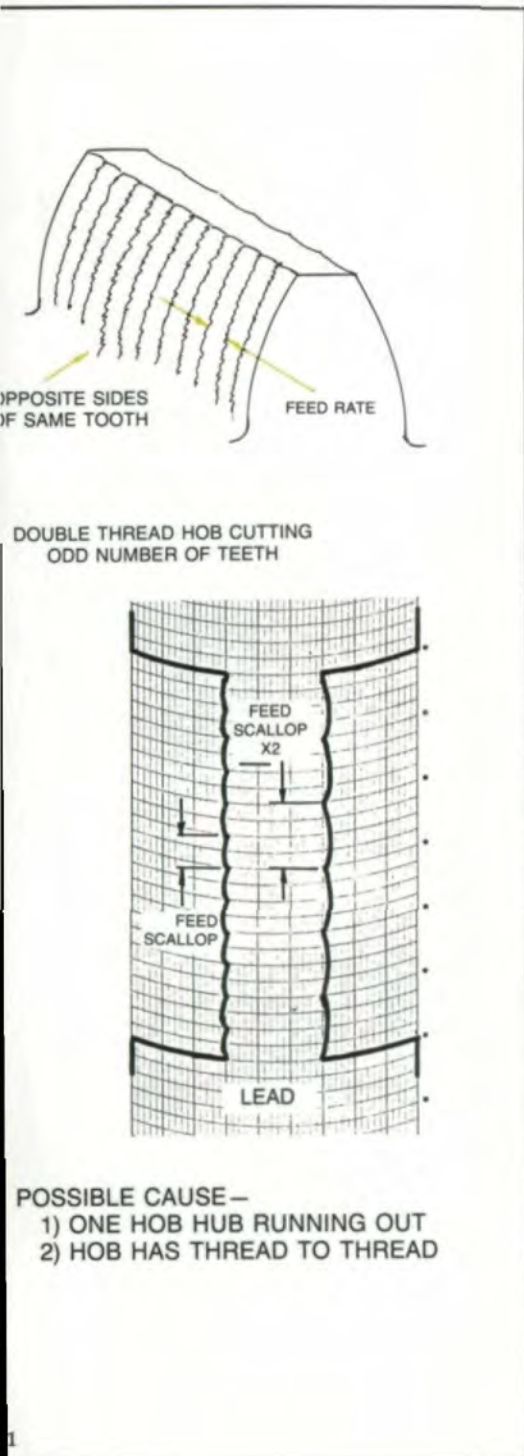

Spiral Bevel Gears up to 100" Diameter



AMARILLO GEAR COMPANY

A Division of the Marmon Group, Inc.
(806) 622-1273 Cable: Amadrive TWX 910-898-4128
P. O. Box 1789, Amarillo, Texas 79105

CIRCLE A-18 ON READER REPLY CARD