

Case Study Involving Surface Durability and Improved Surface Finish

G. Blake and J. Reynolds

(Printed with permission of the copyright holder, the American Gear Manufacturers Association, 500 Montgomery Street, Suite 350, Alexandria, Virginia 22314-1560. Statements presented in this paper are those of the author(s) and may not represent the position or opinion of the American Gear Manufacturers Association.)

Management Summary

Gear tooth wear and micropitting are very difficult phenomena to predict analytically. The failure mode of micropitting is closely correlated to the lambda ratio (Refs. 1–2). Micropitting can be the limiting design parameter for long-term durability. Also, the failure mode of micropitting can progress to wear or macropitting, and then go on to manifest more severe failure modes, such as bending. The results of a gearbox test and manufacturing process development program will be presented to evaluate super-finishing and its impact on micropitting.

Testing was designed using an existing aerospace two-stage gearbox with a low lambda ratio. All gears were carburized, ground and shotpeened. Two populations were then created and tested; one population was finish-honed; the second was shotpeened and isotropic super-finished.

A standard qualification test was conducted for 150 hours at maximum continuous load. The honed gears experienced micropitting and macropitting during the test. The isotropic super-finished (ISF) gears were also tested for 150 hours under the same loading. The ISF gears were absent of any surface distress, and so were then further subjected to a 2,000-hour endurance test. The ISF gears had less surface distress after 2,000 hours than the baseline honed gears after 150 hours.

Introduction

Isotropic super finishing (ISF) is a technology that public literature suggests having potential for increased power density (Ref. 3). Three tests were conducted to test the surface durability difference between honing and ISF. Demonstration of bending fatigue strength was out of scope. Previous testing has shown ISF not to increase bending fatigue strength (Ref. 4).

The testing utilized a Rolls-Royce technology demonstrator gearbox assembled with a gas turbine engine. Testing was performed at Rolls-Royce Corporation in Indianapolis. The gear train on test was a compound idler arrangement (Fig. 1). Two sets of gears from the same manufacturing lot were used for testing. A comparison of the baseline gears and ISF gears is shown in Table 1.

The configuration of Gear C was silver-plated. As such, the ISF test gear was also silver-plated. A chemical process was used to prepare the surface prior to plating to minimize alteration of the surface. Measurement presented later in this paper will show that.

Test methods and parameters. Three tests, using two different sets of gears, were conducted as part of this project. A Rolls-Royce technology demonstrator gearbox was used for all three tests. The first two tests were conducted for 150 hours each; the third was conducted for 2,000 hours.

An aerospace gas turbine load cycle was selected for the first two 150-hour

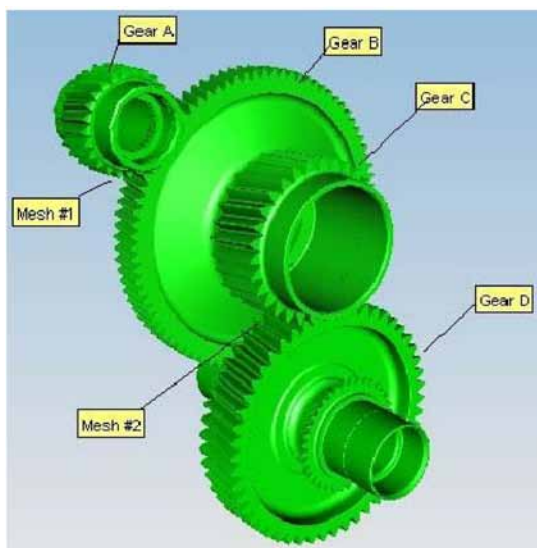

Figure 1—Rolls-Royce demonstrator gear train.

Table 1—Finishing processes of baseline and ISF test gears

Mesh	Gear	Baseline	ISF
#2	D	Ground, shot peened, honed	Ground, shot peened, ISF
	C	Ground, shot peened, honed, silver plated	Ground, shot peened, ISF, silver plated
#1	B	Ground, shot peened, honed, silver plated	Ground, shot peened, ISF, silver plated
	A	Ground, shot peened, honed	Ground, shot peened, ISF

tests. The graph shown (Fig. 2) is the test cycle. The load cycle was repeated 25 times for the baseline and ISF gears. All testing was done with MIL-L-23699 oil.

The ISF gears were reassembled and tested for an additional 2,000+ plus hours. The test was conducted using 14 different duty cycle profiles. A summary of the actual time spent at-power is shown (Fig. 3).

Baseline 150-hour test results. The gear tooth surface condition and any failure modes were classified using ANSI/AGMA 1010-E95 (Ref. 6). Table 2 contains a summary of the baseline gears subsequent to the 150 hour test. Figures 4–7 are low-magnification, white-light photos of the active profile surfaces, post test.

A dimensional and metallurgical evaluation was performed on all baseline gears; all gears were found to be conforming. Figure 8 is a sample post-test photomicrograph showing micropitting of Gear C. Figures 9–11 are post-test analytical inspection traces showing the change in form.

Roughness measurements were made of the baseline gears prior to test (Table 3).

As stated previously, the literature states that surface durability improves with increased specific oil film thickness. The composite roughness is one variable in specific oil film thickness. As such, the gear finishing process has an impact on the specific oil film thickness.

The specific oil film thickness (λ) was calculated for three roughness values (Table 4). The values were calculated at max HP and max oil temperature per AGMA 925-A03. The roughness values were selected based on expected values for typical honing, threshold of honing, and ISF. The calculated specific oil film thickness values were used to guide selection of a finishing process to improve surface durability. Measurement data from

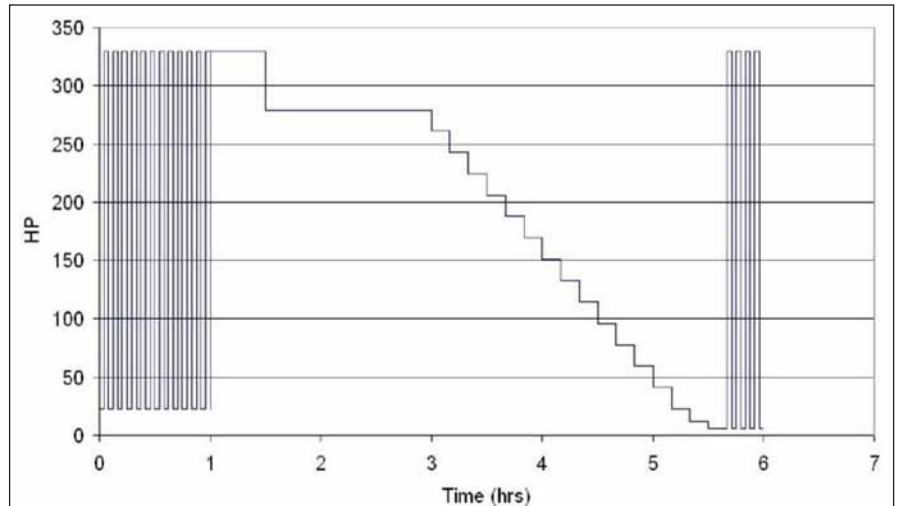

Figure 2—Endurance test (six-hour cycle) repeated 25 times for baseline and ISF gears.

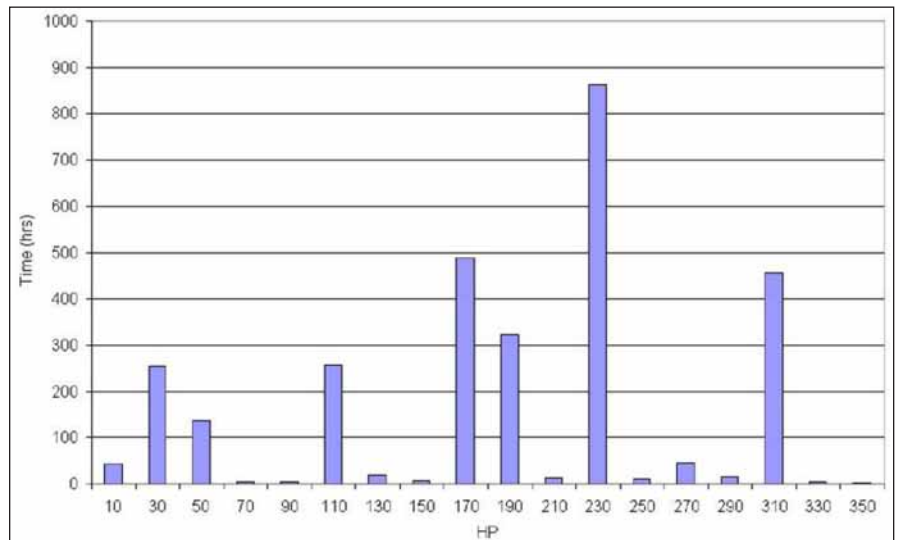

Figure 3—2,000-hour endurance test time at HP.

Table 2—Post-150-hour engine test evaluation of baseline gears

Gear	Failure mode(s) per ANSI/AGMA 1010-E95		
	Failure mode class	General failure mode	Specific mode / degree
D	Wear	Polishing	Moderate
	Contact fatigue	Macropitting	Initial
	Contact fatigue	Micropitting	Progressive
	Scuffing	Scuffing	Mild
C	Contact fatigue	Micropitting	Progressive
	Contact fatigue	Macropitting	Initial
B	Contact fatigue	Micropitting	Progressive
A	Contact fatigue	Micropitting	Progressive



Figure 4—Baseline Gear A, Mesh 1, drive side: post-150-hour test.



Figure 5—Baseline Gear B, Mesh 1: post-150-hour test.



Figure 6—Baseline Gear C, Mesh 2: post-150-hour test.



Figure 7—Baseline gear D, Mesh 2: post 150-hour test.



Figure 8—Sample metallurgical evaluation of Gear C, Mesh 2 displaying micropitting.

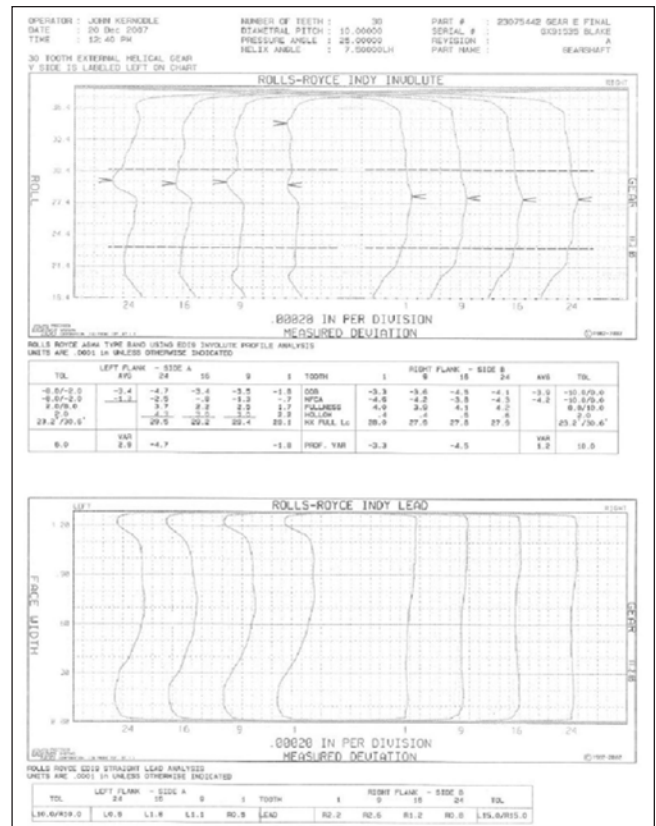
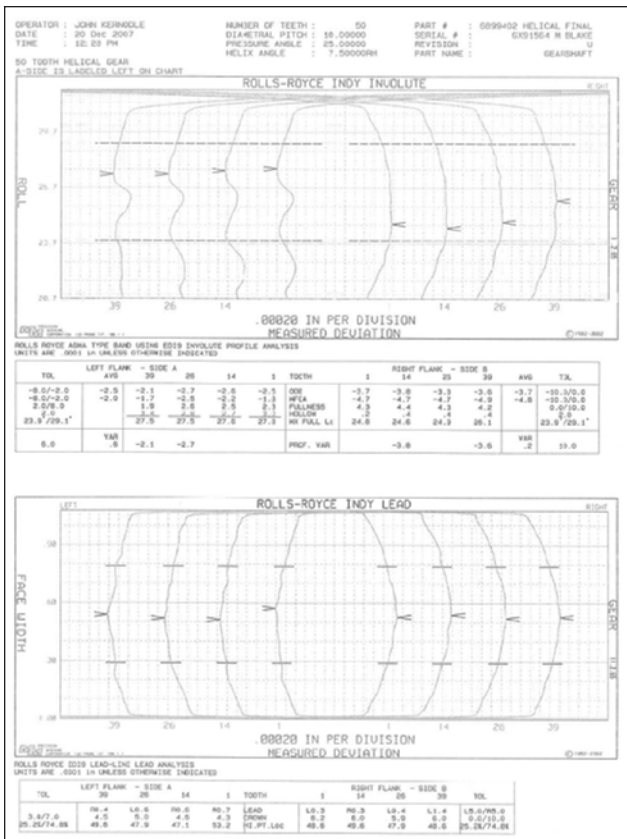

Figure 9—Baseline Gear D, Mesh 2 and analytical inspection: post-150-hour test.

Figure 10—Baseline Gear C, Mesh 2, analytical inspection: post-150-hour test.

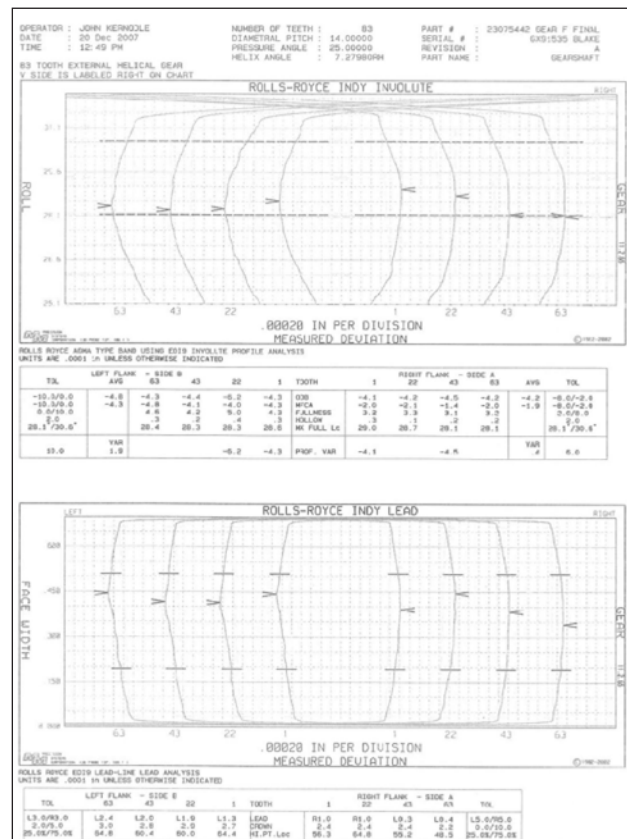

Figure 11—Baseline Gear B, Mesh 1, analytical inspection: post-150-hour test.

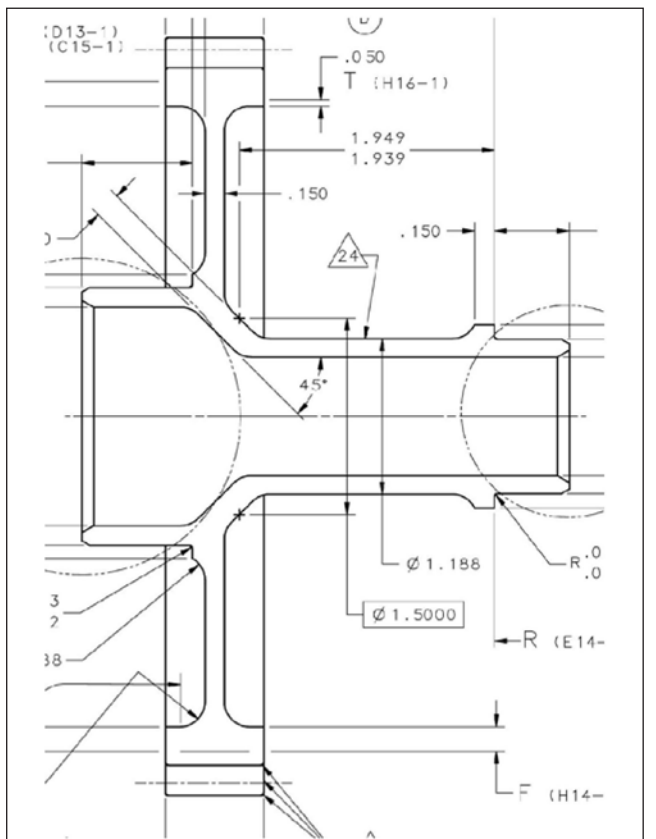

Figure 12—Honing test gear: 56-tooth, 6-DP, 25° nominal pressure angle spur gear.

Table 3—Roughness parameters of baseline gears as measured along involute; units = μin

Part name	Ra	Rp	Rt
Gear D, mesh #2	12.005	19.034	89.541
Gear C, mesh #2	+9.599	+25.026 ¹⁾	73.388 ¹⁾
Gear B, mesh #1	+6.611	+16.464 ¹⁾	48.721 ¹⁾
Gear A, mesh #1	11.222	33.209	57.504

NOTE: 1 = measurement performed post-silver-plate stripping.

Table 4—Calculated, specific oil film thickness vs. roughness for different finishing processes

Finishing process	Ra μin	X	
		Mesh #1	Mesh #2
Production honing	12	0.8434	0.4881
Threshold of honing	8	1.2882	0.7519
ISF	2	5.2601	3.1025

Table 5—Contact fatigue Margin of Safety at maximum HP

Mesh	S _c MOS
#1	1.190
#2	1.340

Table 7—Roughness vs. hone processing time: units = μin

Process time factor	Ra	Rv	Rt
0.0	33.4	92.5	205.4
1.0	11.6	69.8	159.3
1.9	6.8	22.5	98.2
4.4	8.5	40.2	81.6

Table 6—Honing trial process: X = normal processing time

Step	Description
1	Select production part (post grind, pre peen)
3	Shot peen per RR specification
4	Inspection involute, lead, roughness, and waviness
5	Hone (1.0X) using production setup and legacy machine
6	Inspection
7	Hone (1.9X)
8	Inspection
9	Hone (4.4X)
10	Inspection

gears processed each of these four ways is presented later in this paper.

The contact fatigue margin of safety for both gear meshes was calculated and presented in Table 5.

The specific oil film thickness of Mesh 1 is greater than Mesh 2, while the contact fatigue margin of safety is less for Mesh 1 than Mesh 2.

Honing test. Honing is a hard finishing technology for improving gear tooth surface roughness (Ref. 7). A test

was conducted to determine the threshold surface roughness and the geometric interactions. An aerospace spur gear (Fig. 12) was used for the honing test. The gear material and pre-hone processing were common between the test gear and those in the endurance testing. The process time was incrementally increased. Roughness and form were measured at each interval. The test process is listed (Table 6). It should be noted that other hone variables—

hone material, hone geometry, stock removal, traverse speed and rotational speed—can also influence surface roughness and form. The variable cycle time was chosen based on experience.

The post-shotpeening, pre-honing condition of the honing test gear is shown (Fig. 13). Figure 14 shows the honed surface after 4.4X—the normal production process time.

The involute form and surface roughness were measured at each

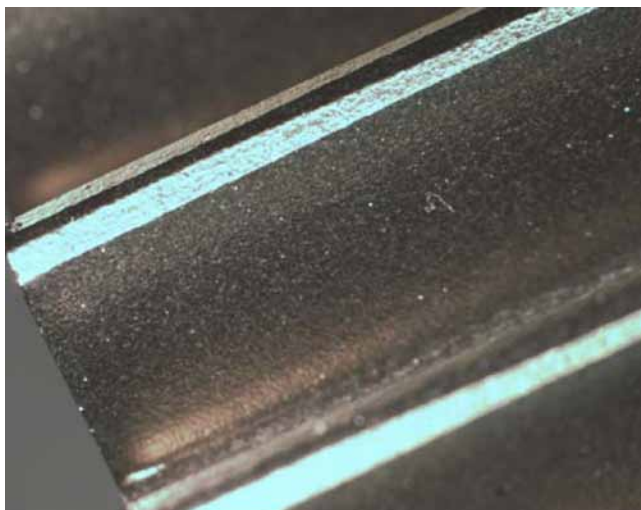

Figure 13—Starting condition: post-shotpeen, pre-hone test gear.

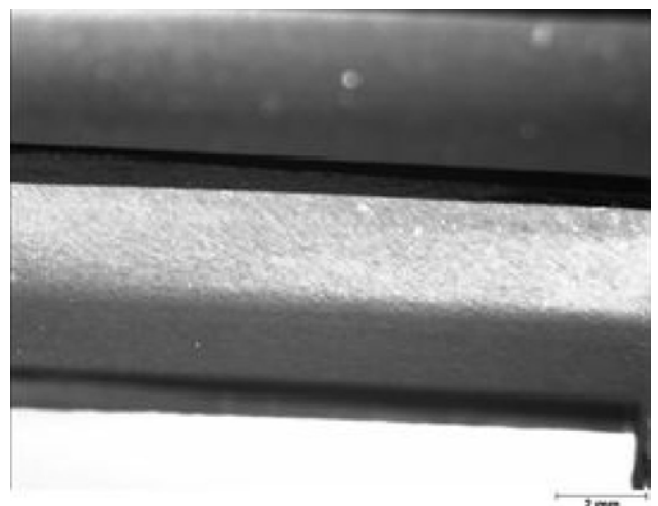

Figure 14—Post-final hone step: 4.4X normal hone process time.

interval. Figure 15 shows the change in roughness and form involute slope error as process time increased. The roughness values are listed (Table 7). The involute traces from each interval were superimposed and shown (Fig. 16). The form error can be seen as localized—near the end of active profile—vs. true slope error.

150-hour ISF test results. A second set of gears was processed using ISF. The ISF gears were incorporated into the same gearbox and tested to the same parameters as the baseline set. Table 8 shows the surface roughness of the ISF gears. Figures 17–20 are low-magnification, white-light photos of the ISF gears post test. The post-test surface distress was minimal and the gear deemed acceptable for further testing.

2,000 hour ISF test results. The same gears used in the 150-hour test were reassembled. Testing was continued at the same parameters for 2,000 hours. Figs. 21–24 are low-magnification, white-light photos of the ISF gears post-2,000 hours. The gears showed little surface distress.

ISF process development. The design requirements for the four gears were as shown in Table 9. The area that is required to be ISF-finished is the full facewidth, including the gear faces on Gears A–D.

Media selection. Media selection was originally based upon a test gear for the process approval. The gear had a much larger pitch, and the media was able to fully engage throughout the profile and root of the test gear. Minimal profile change was present with the process approval test gear. Correct media selection is critical to a successful isotropic finishing process.

Figure 25 shows Gear B and a piece of the initial media used to process the gear. As can be seen, the media is too large to contact the full depth of the tooth.

The media used is a mixture of several different sizes and shapes (Fig. 26).

Figure 27 shows the before-ISF and post-ISF involute form using the initial media.

Media selection for 2nd lot. Selection of the media for the sec-

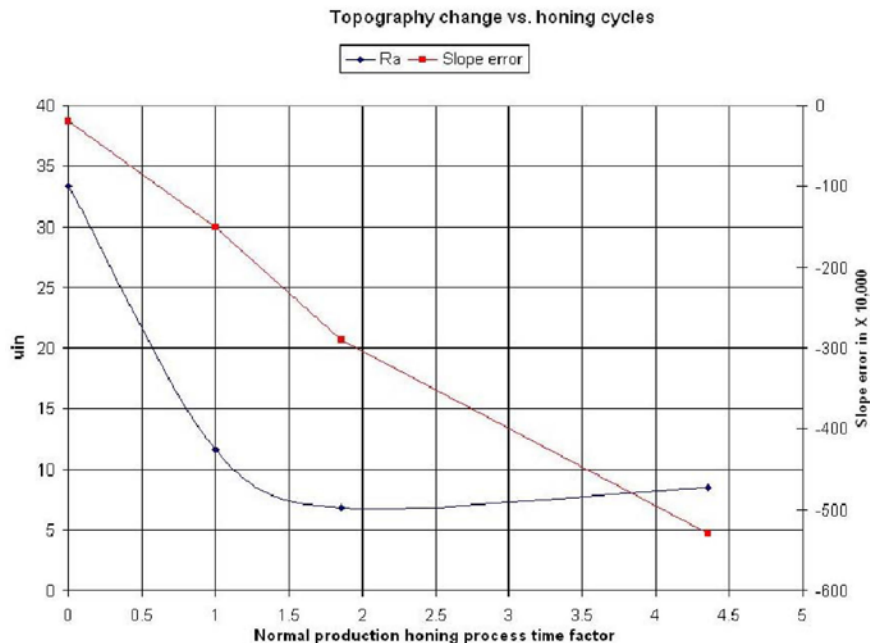

Figure 15—Honing process time vs. gear profile slope error.

Table 8—ISF test gears: roughness parameters as measured along involute, units=μin

Part name	Ra	Rp	Rt
Gear D, mesh #2	1.2	5.8	13.0
Gear C, mesh #2	1.7	6.1	16.0
Gear B, mesh #1	1.8	8.5	15.9
Gear A, mesh #1	2.2	8.3	19.2

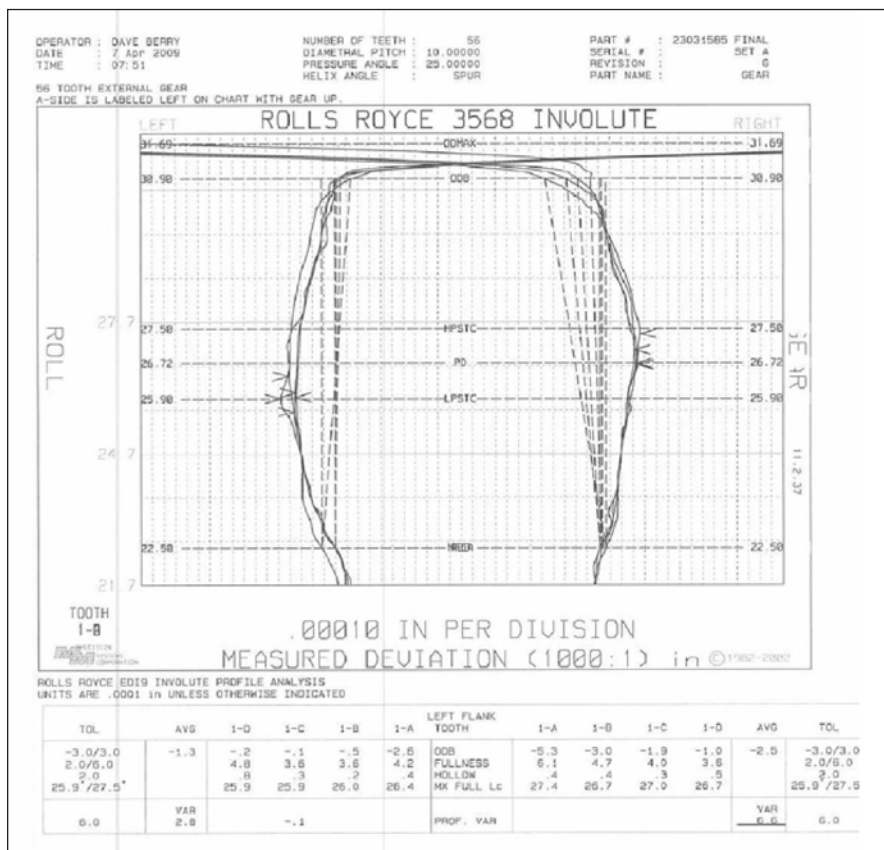

Figure 16—Hone specimen involute comparison after each hone cycle: A=4.4X; B=1.9X; C=1.0; D=0.

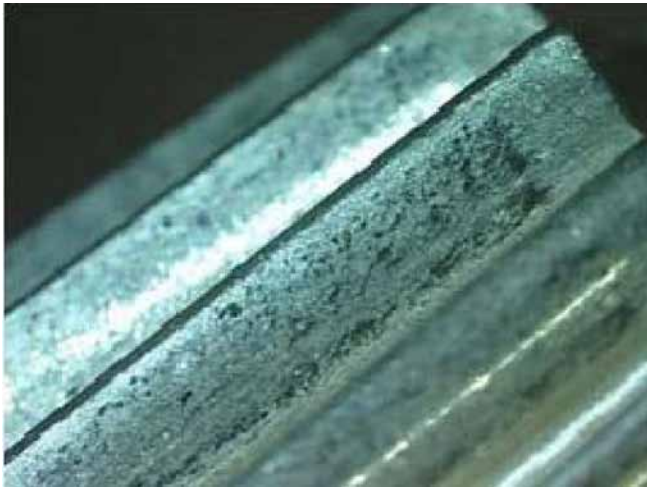

Figure 17—ISF Gear A, Mesh 1: post-150-hour test.



Figure 18—ISF Gear B, Mesh 1: post-150-hour test.



Figure 19—ISF Gear C, Mesh 2: post-150-hour test.

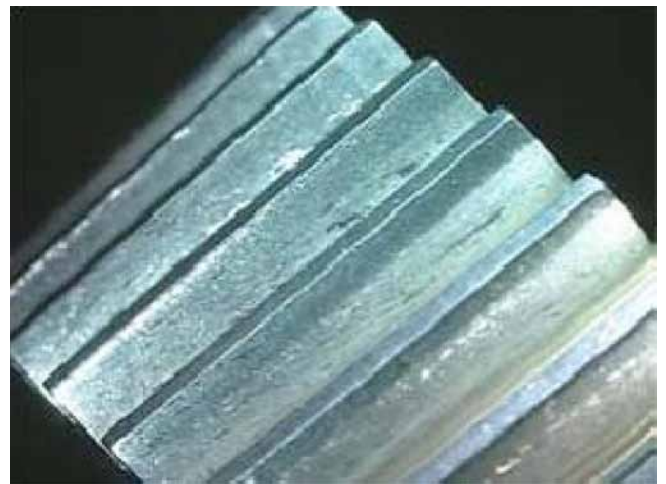

Figure 20—ISF Gear D, Mesh 2: post-150-hour test.



Figure 21—ISF Gear A, Mesh 1: post-2,000-hour test.

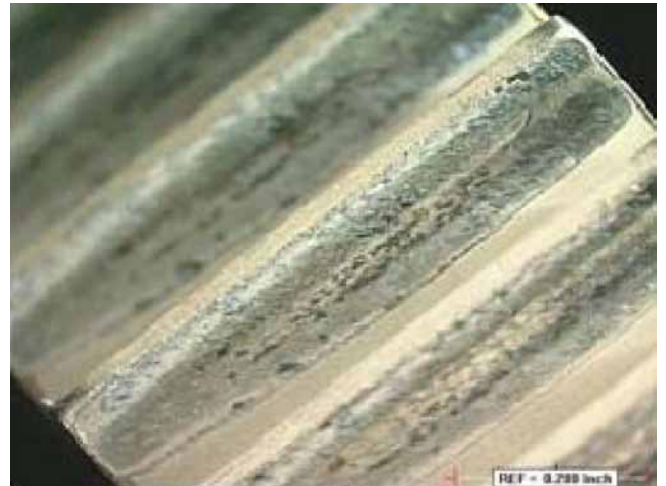

Figure 22—ISF Gear B, Mesh 1: post-2,000-hour test.

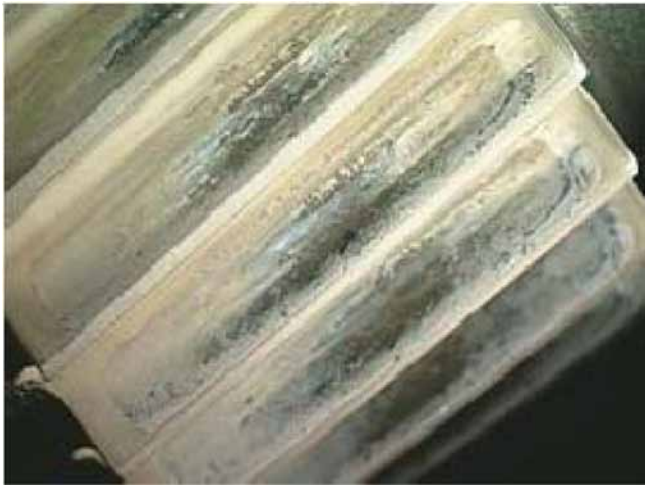

Figure 23—ISF Gear C, Mesh 2: post-2,000-hour test.

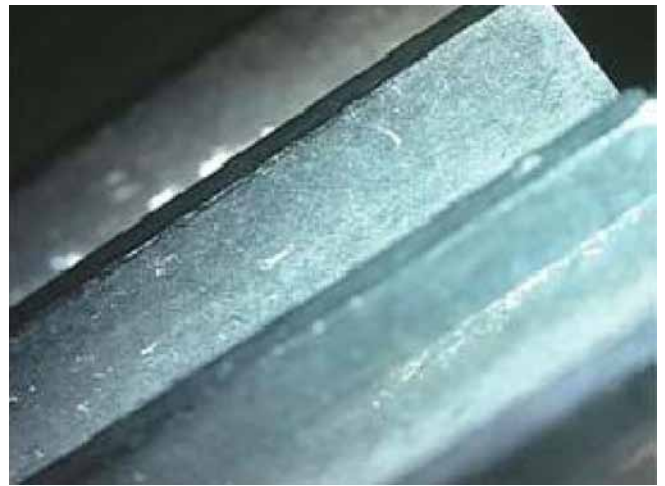

Figure 24—ISF Gear D, Mesh 2: post-2,000-hour test.



Figure 25—ISF process development shown: Gear B.



Figure 26—ISF process development: media mix.

Table 9—Design requirements for ISF development, units = μin

Part name	Surface Ra
Gear A	4
Gear B	4
Gear C	4
Gear D	4

GEAR CHARTS

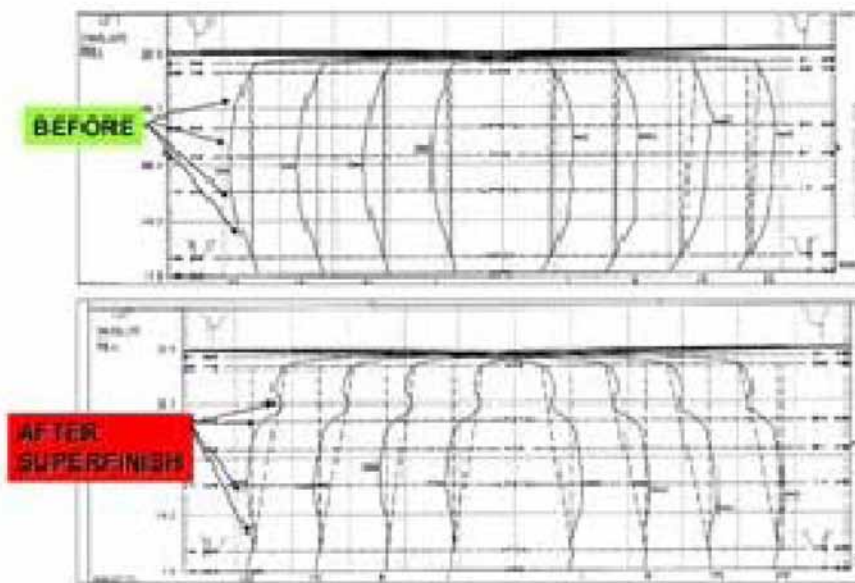

Figure 27—ISF process development: gear chart showing excessive tip stock removal.



Figure 28—Gear B with smaller ISF media.



Figure 29—ISF process development: final ISF media mixture used for test gears.

ond lot of parts involved a new media that fit the gear tooth pitch. Figure 28 shows Gear B and the smaller media fitting into the tooth space to the root. The final media mixture used is shown (Fig. 29).

Dimensional change through ISF.

The dimensional change through ISF was established during process development.

The pre- and post-measurement data of roughness and basic dimensions is shown (Tables 10–11). Figure 30 shows the pre- and post-involute form. The degradation observed in the initial trials (Fig. 27) was eliminated with the smaller media.

Conclusions

- This case study demonstrated that surface durability is related to specific oil film thickness, which is related to surface roughness.
- Decreased surface roughness is one method of increasing specific oil film thickness.
- Honing and ISF are gear finishing processes that improve surface finish.
- The ISF process produced a surface with a lower roughness than honing.
- Gears processed with ISF had improved resistance to micropitting and thus longer surface durability life.

Acknowledgments. The authors would like to thank the following organizations for their contributions: Rolls-Royce Helicopter Engine Program for technical oversight, funding and support of this project.

- Metal Improvement Co. and REM Chemical for super-finishing selected test gears. 

References

1. Drago, R. *Fundamentals of Gear Design*, Butterworth Publishers, Stoneham, MA, 1988.
2. Alanou, M., H. Evans, T. Krantz and R. Snidle. "An Experimental Investigation of the Influence of the Lubrication Viscosity and Additives on Gear Wear," Report ARL-TR-3126, U.S. Army Research Lab, Cleveland, OH, 2005.
3. Manesh, A., and P. Niskanen. *Engineered and Super-finished Surfaces for Precision Aerospace Applications*, ITT Research Institute, Chicago, IL, PTSM 02-001, 2003.
4. Blake, G. "Effects of Super-finishing on Bending Fatigue," AGMA 06FTM01.
5. AGMA 925-A03. Effect of Lubrication on Gear Surface Distress.
6. ANSI/AGMA 1010-E95. Appearance of Gear Teeth -Terminology of Wear and Failure.
7. *Modern Methods of Gear Manufacturing*, published by National Broach & Machine, 1972.

Table 10—Pre-ISF measurements

	Ra after shot peen	Root diameter	Outside diameter	Face width	DOP
Gear A	19.2	1.683	2.009	.892	2.081
Gear B	23.4	5.847	6.1753	.678	6.2635
Gear C	19.7	2.787	3.2672	1.267	3.2945
Gear D	20.2	4.751	5.199	1.057	5.2357

Table 11—Post-ISF measurements

	Ra after ISF	Root diameter	Outside diameter	Face width	DOP
Gear A	2.728	1.683	2.009	.892	2.081
Gear B	2.547	5.847	6.1753	.677	6.2633
Gear C	2.263	2.787	3.2672	1.267	3.2943
Gear D	2.826	4.751	5.199	1.057	5.2355

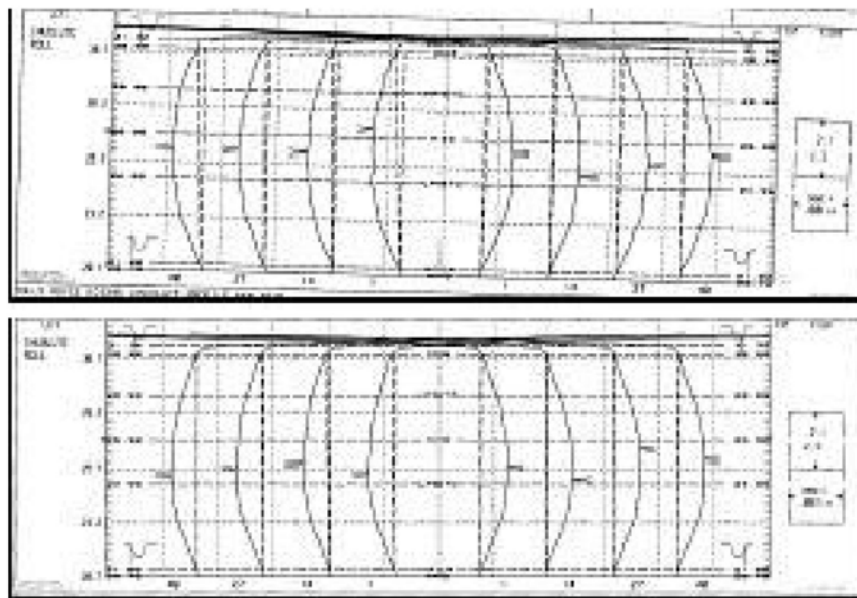

Figure 30—Pre- and post-ISF involute form traces.

Gregory Blake is a senior specialist and mechanical engineer at Rolls Royce Corporation, where he is product definition manager of gearboxes. His primary professional experience is in the areas of gear manufacturing, design, product development and technology.