

# gear

TECHNOLOGY<sup>®</sup>

MAR/APR  
2020

# CUTTING TOOLS

GAGES

AEROSPACE  
GEARS





# FFG Modul H200

Automotive applications  
made flexible

The H 200 Vertical Gear Hobbing Machine is designed for small automotive applications, specifically dry cutting applications, although wet applications work as well.

The H200 is available with an optional extended radial travel, incorporating the working range of 80 mm to 200 mm. Improved part change is available on the H 80-130 pinion sized machines for the high speed hobbing of automotive pinions. This process, with a "chip to chip" time of less than 2 seconds, combines the flexibility of our high-speed CNC double gripper gantry loader and CNC tailstock. The new CNC tailstock, driven by a servomotor, is standard now and allows the easy setup of programming and monitoring of the clamping force and position. The closed "O-frame" structure with cross beam allows the ideal integration of this tailstock. These new features, combined with the user-friendly FFG Modul operating interface, provide also the optimal base for Job Shop applications.



SAMPUTENSILI



Phone: 847-649-1450

5200 Prairie Stone Pkwy. | Ste. 100 | Hoffman Estates | IL 60192



**SICMAT**

 **Profilator**



[www.star-su.com](http://www.star-su.com)



A Publication of  
The American Gear  
Manufacturers Association



18

## features

- 18 Tinkering with Carbide**  
Everybody's working with carbide tools these days, but carbide materials still have one big shortcoming: their tool life. However, these cutting tool companies think they might have some solutions.
- 24 Real-Time Measurement Opportunities**  
Shop floor inspection and gaging equipment is putting advanced metrology systems right on the factory floor.
- 36 Documentation: A Challenge in Making Aerospace Gears**  
Aerospace industry dealing with increased demands for documentation.
- 40 Analyzing Bevel Gear Damage Prediction Over Operating Life**  
As product development cycles become shorter, powerful modeling approaches and calculation algorithms become increasingly important.

## technical

- 44 Ask the Expert**  
Shaft Positioning Tolerances for Bevel Gears
- 50 Calculated Scuffing Risk: Correlating AGMA 925-A03, AGMA 6011-J14 and Original MAAG Gear Predictions**  
A study that looks specifically at gears that are finish ground and considered high-speed per ANSI/AGMA 6011, and meshing elements with pitch line velocities in excess of 35 m/s or rotational speeds greater than 4,500 rpm.

PRÄWEMA – The leading manufacturer  
of Gear Honing machines

PRÄWEMA

DVS  
TECHNOLOGY  
AMERICA

- Best quality with finest surface
- High efficiency with low tool costs due to high flexibility in micro data corrections
- Most experience with interference and timing gears



Wide range of workpieces



Curious to learn more?  
CONTACT US:

DVS Technology America Inc.

☎ 734-656-2080

✉ [sales.america@dvs-technology.com](mailto:sales.america@dvs-technology.com)

[www.praewema.de](http://www.praewema.de)

PRÄWEMA SynchroFine®  
State of the art for Gear Hard Finishing

[www.dvs-technology.com](http://www.dvs-technology.com)

DVS  
TECHNOLOGY  
GROUP



# PROFITABLE PRODUCTION, PERFECTED.



Empower your team with the latest profitable gear manufacturing technology.  
 Call us today to speak with an engineer about your next machine, tool, or service solution, or to schedule a demonstration of a Hera hobbing machine!



847-931-4121 | sales@heliosgearproducts.com

**HeliosGearProducts.com**

# gear TECHNOLOGY®

Vol. 37, No. 2

## departments

- 06 GT Extras**  
 GT Videos: Marposs M62 Flex; Automotive Gear Grinding with Norton; Upcoming Events
- 09 Publisher's Page**  
 Keeping Things Moving.
- 10 Editorial**  
 Developing Certainty in Uncertain Times
- 12 Product News**  
**Gleason** vertical power skiving machines with on-board cutter re-sharpening; **Haas** gear skiving developments; **Solar Atmospheres** scanning electron microscope; **Marposs** new probing software
- 58 Industry News**  
 News and notes from **Helios Gear**, **Index**, **Kapp Technologies** and more.
- 62 Advertiser Index**  
 Contact information for companies in this issue.
- 63 Subscriptions**  
 Fill out the form to continue receiving *Gear Technology*.
- 64 Addendum**  
 Using Gears to Pour a Beer.





## WGT Gear Measuring Machines



- Highest accuracy is guaranteed by using granite guides, air bearings, precision rotary table and Renishaw scanning probe
- Low cost of ownership and high uptime
- User friendly software packages for various types of gears, gear cutting tools and shaft geometry
- Ergonomic design
- Manufacturer neutral GDE interface for data transmission to production machines

THE GEAR INDUSTRY'S  
INFORMATION SOURCE

[www.geartechnology.com](http://www.geartechnology.com)

**Marposs M62 Flex**

Watch this demonstration video to see how simple and practical it is for the inspection of gears with Marposs M62 Flex.

[www.geartechnology.com/videos/Marposs-M62-Flex-/](http://www.geartechnology.com/videos/Marposs-M62-Flex-/)



**Automotive Gear Grinding with Norton**

Increasingly stringent industry requirements for gear grinding demand higher profile accuracy and improved surface finishes. Learn more here:

[www.geartechnology.com/](http://www.geartechnology.com/)

[videos/Norton-Xtrimium-for-Gear-Grinding-Automotive-/](http://www.geartechnology.com/videos/Norton-Xtrimium-for-Gear-Grinding-Automotive-/)

**Liebherr LK 300 Gear Skiving**

An external skiving planet carrier with multiple gears and tandem tool from Liebherr. Learn more here: [www.geartechnology.com/videos/Liebherr-LK-300-Gear-Skiving-/](http://www.geartechnology.com/videos/Liebherr-LK-300-Gear-Skiving-/)

**Upcoming Events**

Be sure to check our online event calendar to see the latest trade show news and to keep track of upcoming schedule changes.

[www.geartechnology.com/events.htm](http://www.geartechnology.com/events.htm)

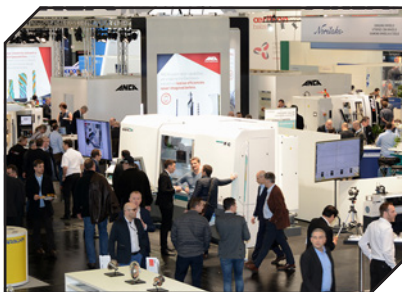

**Stay Connected**



Join the Gear Technology Facebook group at [www.facebook.com/groups/21089032629794/](http://www.facebook.com/groups/21089032629794/)

Follow us on Twitter  
[twitter.com/#!/Gear\\_Technology](https://twitter.com/#!/Gear_Technology)



Connect with us on LinkedIn  
[www.linkedin.com/groups/3893880/](http://www.linkedin.com/groups/3893880/)

Subscribe Online  
[www.geartechnology.com/subscribe.htm](http://www.geartechnology.com/subscribe.htm)



**gear**  
TECHNOLOGY®



**AGMA MEDIA**  
1840 JARVIS AVENUE  
ELK GROVE VILLAGE, IL 60007  
(847) 437-6604  
FAX: (847) 437-6618

**EDITORIAL**

**Publisher & Editor-in-Chief**

Randy Stott, vice president Media  
[stott@agma.org](mailto:stott@agma.org)

**Senior Editor**

Jack McGuinn  
[mcguinn@agma.org](mailto:mcguinn@agma.org)

**Senior Editor**

Matthew Jaster  
[jaster@agma.org](mailto:jaster@agma.org)

**Associate Editor**

Alex Cannella  
[cannella@agma.org](mailto:cannella@agma.org)

**Technical Editors**

William (Bill) Bradley, Robert Errichello, John Lange, Joseph Mihelick, Charles D. Schultz, P.E., Robert E. Smith, Mike Tennutti, Frank Uherek

**DESIGN**

**Art Director**

David Ropinski  
[ropinski@agma.org](mailto:ropinski@agma.org)

**ADVERTISING**

**Associate Publisher & Advertising Sales Manager**

Dave Friedman  
[friedman@agma.org](mailto:friedman@agma.org)

**Materials Coordinator**

Dorothy Fiandaca  
[fiandaca@agma.org](mailto:fiandaca@agma.org)

**China Sales Agent**

Eric Wu, Eastco Industry Co., Ltd.  
Tel: (86)(21) 52305107  
Fax: (86)(21) 52305106  
Cell: (86) 13817160576  
[eric.wu@eastcotec.com](mailto:eric.wu@eastcotec.com)

**MANAGEMENT**

**President**

Matthew E. Croson  
[croson@agma.org](mailto:croson@agma.org)

**ACCOUNTING**

**Accounting**

Luann Harrold  
[harrold@agma.org](mailto:harrold@agma.org)

**FOUNDER**

Michael Goldstein founded Gear Technology in 1984 and served as Publisher and Editor-in-Chief from 1984 through 2019. Thanks to his efforts, the Michael Goldstein Gear Technology Library, the largest collection of gear knowledge available anywhere, will remain a free and open resource for the gear industry. More than 36 years' worth of technical articles can be found online at [www.geartechnology.com](http://www.geartechnology.com). Michael continues working with the magazine in a consulting role and can be reached via e-mail at [michael@geartechnology.com](mailto:michael@geartechnology.com).



**BOURN &  
KOCH 400H  
GEAR HOBBING  
MACHINE**

# SKIP THE GRIND

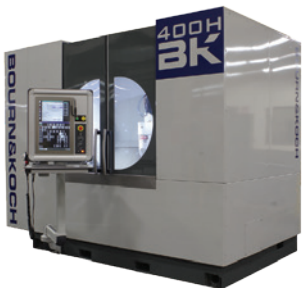

## **CONTINUING THE BARBER-COLMAN LEGACY OF MANUFACTURING **WORLD-CLASS GEAR MACHINES.****

- For external spur and helical gears
- Up to 400mm part diameter
- Wet or dry hobbing
- Fanuc OiF controller
- 7-axis CNC standard
- Produces AGMA Class 9-10 gears without grinding
- Full-machine enclosure with optional automatic door



**MITSUBISHI**  
HEAVY INDUSTRIES AMERICA, INC.

Our Technologies, Your Tomorrow

We have the  
**POWER** to make  
your business  
**A FORCE**



**GE**series



**SE**series



**FE**series



**ZE**series



### **Gear Machines That Drive Business Forward**

With Mitsubishi's full line of proven gear machines delivering incomparable reliability, performance, flexibility and quality, you can turn your production and cost controls into a force to be envied. These machines offer an array of options that are sure to satisfy any demand, including machine diameters ranging from 60mm to 2000mm and processes for hobbing, shaping, milling, chamfering, deburring, shaving and grinding—all with or without automation. Don't hesitate to contact us for assistance; our fast engineering response team is ready to provide the world class performance of Mitsubishi gear machines at [www.mitsubishigearcenter.com](http://www.mitsubishigearcenter.com) or contact sales at 248-669-6136.

# Keeping Things Moving

**Over the past month, everything about our world has changed. The COVID-19 pandemic has brought most aspects of our lives to a grinding halt.** We can't go out to eat. We can't travel. We can't even go to church. A lot of businesses are struggling.

But at the same time, there are a lot of people who are busier than ever. In some cases, frighteningly so.

I'd like to take this opportunity to thank all of those on the front lines of this unprecedented battle. Healthcare workers are literally risking their lives to save as many others as possible, and they're doing so without the resources they need. It goes without saying that those people deserve our support and our thanks. But I'd also like to recognize all of the grocery store clerks and gas station attendants, the truck drivers and the mail carriers, the fast food workers and trash collectors, none of whom have the option of working from home, but all of whom are essential for the rest of us to maintain some minimal level of normalcy. None of the rest of us could survive for long without their efforts.

Lastly, I'd like to thank all of you.

Most of you who read this magazine work for manufacturing operations that have been deemed essential businesses. We've talked with many of you who are keeping your doors open and operating through the crisis. In some cases, you've even indicated that you've added shifts to keep up with demand.

More than a few of you have told us you're directly helping fight this battle by providing specialized components necessary for the production of ventilators, test kits, hospital beds and other emergency medical supplies. Others continue to do what they've always done, providing the gears and gear drives necessary for transportation, energy production, paper production, steel mills, and so on.

Gears and gear drives are necessary for the production of almost everything.

So thank you, gear manufacturers, for helping to keep our country running while much of the world hunkers down. I'm proud to know as many of you as I do, and I'm proud to be affiliated with this vital industry.

For our part, *Gear Technology's* staff will keep providing you with the best possible information on gear design, manufacturing, inspection, heat treating and use. Although all of the magazine staff members are working from home, we're still working, and we're here for you.



**Publisher & Editor-in-Chief**  
Randy Stott

Feel free to reach out to me personally – or to any member of the AGMA Media staff – if you need information about anything. We have the ability to communicate very quickly – via our e-mail newsletters or social media – to the gear manufacturing community around the world. If you're facing new challenges, we can help you find solutions. Also, please read the comments from Matt Croson, President of the AGMA, regarding all the things the association is doing to help its members and the industry during this time of crisis (page 10).

My thoughts and best wishes are with you all.

P.S. If you happen to be working from home during these tough times (and even if you're not!), now is a great time to renew your subscription to *Gear Technology*. Did you know that you can specify delivery to your home address and/or choose the electronic-only delivery method? The Michael Goldstein Gear Technology Library, found at [www.geartech-nology.com](http://www.geartech-nology.com), continues to be the best resource for top-quality technical content related to gears. You can access it any time, free of charge and without any restrictions, from anywhere in the world.

# Developing Certainty in Uncertain Times

When I started as AGMA's seventh president in its 100<sup>th</sup> year in June 2016, I shared two philosophical approaches I have leveraged as an association professional:

1. **We are Here for You.** Call us, email us, give us your thoughts on how we can help — AGMA is here for you.
2. **Onward and Upward.** This is an old boy scout saying we used when climbing Long's Peak, Mt. Rainier, Mt. Katahdin, the Tooth of Time, Baldy Mountain and other peaks my Troop 167 reached. It is a message that reminds us we need to keep moving.

There is no question that every executive reading this column is in the middle of a very real crisis. We are all making personal and professional decisions that impact our families and businesses, directly and in a very real manner. We are experiencing many firsts — and between ensuring the safety of our families and business colleagues, meeting customer demand, achieving the required cash flow and staying mentally strong and optimistic — well — it's a lot.

As I am writing this, nearly half of America is in lockdown mode. Governors across the country have restricted movement and business operations, and they're asking many of you to work remotely. AGMA's teams in Virginia and Illinois join you in this, working from home until at least April 7.

My message to you all is just as I expressed in June 2016 — AGMA is here for you — just differently.

We were forced to cancel the 104<sup>th</sup> Annual Meeting, and we have postponed our face-to-face classes in March and April. Now we're potentially postponing our May events as well.

But AGMA continues to be here for you. We have incredible resources — many of which digital — and I encourage you and your team to tackle this terrible situation by leveraging AGMA to develop certainty via our online and traditional print vehicles.

Here's how:

- Your executive team should sign up for the four upcoming webinars we are hosting:
  - Jim Meil on the current and near

- future economy, as best as we know it
  - Peter Zeihan on macro issues impacting us on a global, geopolitical level, including issues like the Corona-19 Virus and what it means for our future,
  - A.B. Stoddard on how all of these comes together in light of the presidential election cycle what our choices are for the future of America's leadership, and
  - IHS Markit on supply chain impacts and the gear market report.
- Your sales team should sign up for the AGMA Gear Market Report program. The program is now only \$1,000 and guarantees four 150+ page PowerPoint Reports on the Macro Economy, focused Market Trends, and the Gear Market Report which consolidates Federal and self-reported data into a forecast.
- Your engineering and machine operator teams should focus their time and attention on:
  - Taking AGMA's online training programs that can be found at [www.agma.org/education/online/](http://www.agma.org/education/online/)
  - Reviewing the 10,000+ Michael Goldstein Gear Technology Library at [www.geartechnology.com](http://www.geartechnology.com), for pertinent articles covering your products,
  - They should also take advantage of networking with the industry experts and sign up to participate on one of AGMA's or ABMA's 23+ technical committees.

You also can't stop marketing — there will be an upturn after the immediate crisis of the situation is over.

Now more than ever, having a digital and print presence is essential for survival. Email and mail are still running and your brand deserves the best platforms to showcase your company's abilities.

AGMA Media has the resources you need. Whether you are looking to write a blog shared throughout the industry social media channels, or perhaps you would like to demonstrate your subject matter expertise in an article in *Gear Technology* or *Power Transmission Engineering*, AGMA has the channel for you to use.

We understand the uncertainty of decisions that you have to make right now,

and so while we continue to offer online education, online webinars for up-to-date information, we also want to offer a way for you to reach your customers.

AGMA members have an advantage during this time because you have us, and as I said — we are here for you. We are stewards for our industry, and we are your best advocates. Contact us today to see how we can help you.

For *Gear Technology* or *Power Transmission* Editorial: Randy Stott at [stott@agma.org](mailto:stott@agma.org).

For *Gear Technology* or *Power Transmission* Advertising: Dave Friedman at [friedman@agma.org](mailto:friedman@agma.org).

For AGMA Gears Matter Blog or Marketing assistance: Rebecca Brinkley at [brinkley@agma.org](mailto:brinkley@agma.org).

I will close with my second philosophy — onward and upward.

Onward and upward we will climb — to our destination. It's a simple mountaineer's term that says what it needs to say, "Get Moving. Take Action." It's clear right now, this path isn't easy; it's not a straight, flat path. It's rocky, icy, and we may have to go down before we go back up — but onward and upward we will climb — with mental and physical strength as leaders coupled with leveraging the AGMA resources we have developed to support your team.

We will get through this, and we will be stronger for it.

I sincerely wish you all the very best as you work through the next few weeks and months.

**Matt Croson, President**  
*American Gear Manufacturers Association*



ISO 9001  
AS9100  
ISO 13485  
ITAR certified  
WBENC

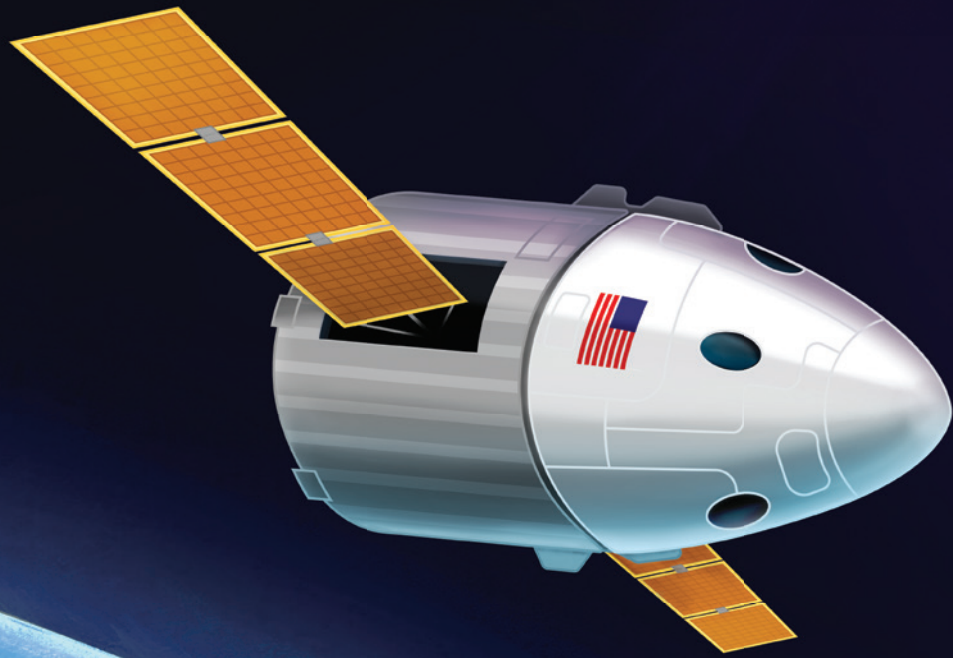

World-class  
Gears for  
...  
Orbiter  
Rover  
Satellite  
Space Station  
Space Plane  
Lander  
Crewed  
Uncrewed  
Launch Vehicle

# For Those Who Know No Limits

Advanced Materials, Engineered to Propel Discovery



## Gleason

### VERTICAL POWER SKIVING MACHINES EQUIPPED WITH ON-BOARD CUTTER RESHARPENING UNIT

A fully integrated on-board cutter resharpening unit is now available for Gleason Vertical Power Skiving machines, allowing for the completely automated resharpening of cutters used in the production of both soft and hardened gears up to 600 mm in workpiece diameter.

By automating cutter resharpening operations, Gleason Power Skiving machines require minimum operator involvement, greatly reducing the time typically required for frequent tool changes and subsequent first-part inspection cycles. Additionally, the usual cost for external tool refurbishment can be avoided.

As compared to the typical cutter resharpening process, the new on-board unit is remarkably fast and simple. The machine's axes position the cutter to the grinding wheel. The integrated cutter resharpening unit then executes the necessary grinding strokes while the cutter



performs the infeed and the indexing from tooth to tooth, all performed automatically and based on the cutter geometry that exists after a certain number of gears have been cut. After the initial corrections are made based on the first gear cut, a consistent gear quality is more easily maintained throughout the complete tool life. The frequency of the resharpening cycles can be chosen depending on the gear quality required.

Tool cost-per-piece is also considerably lower as compared to external

reconditioning with no tool changes, first-part-inspections and machine adjustments during a cutter's lifetime, as well as no handling and logistics costs for conditioning cycles. With a lot less cutters in circulation, tool investment is significantly reduced.

#### For more information:

Gleason Corporation  
Phone: (585) 473-1000  
[www.gleason.com/ps-cutter-sharpening](http://www.gleason.com/ps-cutter-sharpening)

## Helios Gear Products

### KFS 100 AND 250 SHARPENERS TURN 20

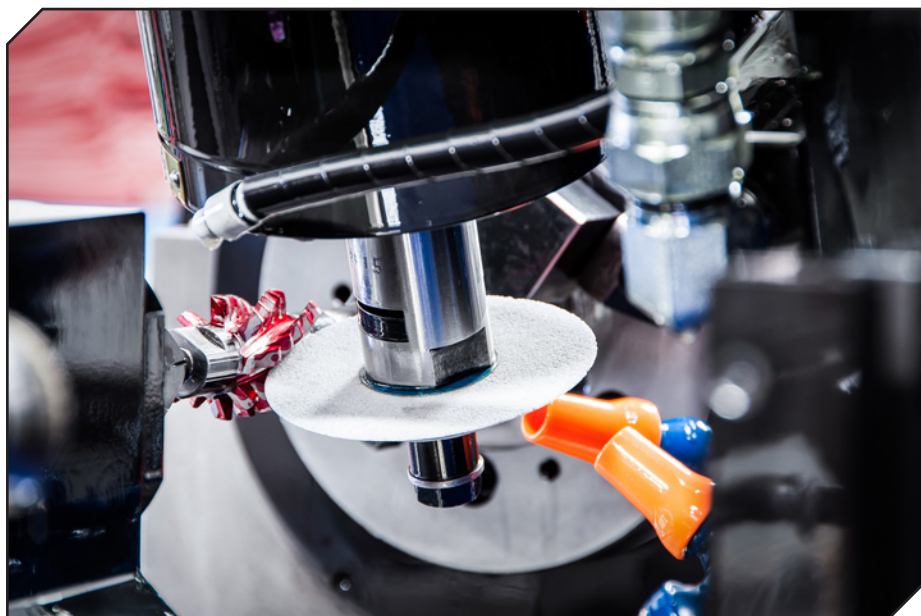

In 1999, the global gear manufacturing industry suffered from limited choices of CNC gear tool sharpening equipment. Consequently, Helios Gear Products began development of an American designed, American-built machine tool dedicated for resharpening hobs, shaper cutters, and milling cutters. Today, 20 years later, these "KFS" machines have been installed on 4 continents. "Our KFS series provides manufacturers around the globe a top-quality solution dedicated and focused on gear tool resharpening," said Adam Gimpert, president of Helios.

Helios continues to develop the KFS line with the latest features dedicated to gear manufacturers. The machine's easy-to-use interface offers manufacturers a turnkey solution with minimal learning curve. Each machine processes dozens of

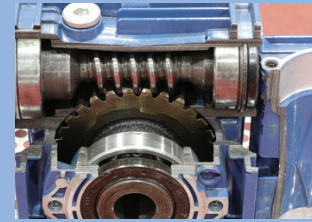
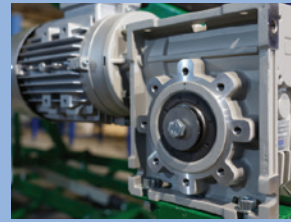
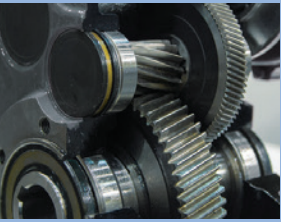

# ADVANCED 100% SYNTHETIC GEAR OILS

## FROM A COMPANY ADVANCING LUBRICATION FOR 150 YEARS

150 years ago, our founders set out to make the highest quality, best performing lubricants available. In doing so, they helped pioneer the use of anti-wear additives that significantly increased lubricant performance through the years. Today, that innovative tradition continues with our newest line of ultra high-performance, 100% synthetic gear oils. These new lubricants provide a wide range of benefits including: extended fluid change intervals, cooler operating temperatures, reduced friction and reduced downtime.

Products include...

### SYN LUBE SERIES 150 - 1000

High performance, fully compatible PAO-based gear oils.

### SYN LUBE HD SERIES

Heavy-duty, (EP) extreme pressure, PAO-based gear oils.

### SYNTHETIC WORM GEAR LUBRICANT

High performance, ISO 460 Grade, PAO-based worm gear oil.

### PGO SERIES

Ultra high-performance, PAG-based gear oils.

### PGO-FGL SERIES

NSF H1 registered, food machinery grade, PAG-based gear oils.

### SFGO ULTRA SERIES 150 - 1000

NSF H1 registered, food machinery grade, PAO-based gear oils.

QUALITY  
INNOVATION  
PERFORMANCE  
FOR 150 YEARS



CELEBRATING  
**150** YEARS  
OF QUALITY, INNOVATION  
AND PERFORMANCE

INCLUDED AT NO ADDITIONAL CHARGE



### Complimentary Extra Services Package

COLOR CODED LUBE CHARTS & MACHINERY TAGS  
PLANT SURVEYS / TECH SUPPORT / TRAINING  
LUBRICATION SOFTWARE / FOLLOW-UP OIL ANALYSIS

LUBRIPLATE LUBRICANTS COMPANY  
NEWARK, NJ 07105 / TOLEDO, OH 43605 / 800-733-4755  
LubeXpert@lubriplate.com / www.lubriplate.com



gear tools per shift, including bore- and shank-type tools, straight- and helical-gash hobs, milling cutters, and shaper cutters. The KFS 100 is rated for tools up to 4.0" diameter whereas the KFS 250 is rated for tools up to 10.0" diameter. These workhorses easily meet AGMA AAA specifications, which ensures hob quality is maintained as a result of the resharpener process.

Manufacturing personnel also prefer the KFS's ergonomic features, such as comfortable access to all spindles (grinding, work, and onboard dresser), integrated crane for assisted loading of large tools, and a filtration system on rails integrated in the machine bed for easy service.

Under the hood, the KFS series offers several state-of-the-art features. The centrifuge filtration system provides a clarity level of 2–5 microns for efficient grinding, and because it is integrated into the bed, it minimizes the machine's footprint, saving valuable shop floor space. The machines utilize the latest Fanuc CNC systems, precision pre-loaded linear guideways, high-speed grinding spindles, and direct-drive motors for ultimate quality.

The KFS CNC gear tool sharpeners are proudly developed, built, and serviced by Helios Gear Products, LLC in South Elgin, Illinois. As Helios looks to the next 20 years of the KFS series, additional improvements are planned. The KFS will remain the leading dedicated gear tool resharpener solution across the globe for its robust set of features, high productivity, and AAA accuracy performance.

**For more information:**

Helios Gear Products  
Phone: (847) 931-4121  
[www.heliogearproducts.com](http://www.heliogearproducts.com)

## Index

### ANNOUNCES NEXT-GENERATION MULTI-SPINDLE AUTOMATIC LATHE

Index has announced the launch of its next generation MS32-6 multi-spindle automatic lathe. This newest version of the six-spindle machine brings the benefits of multi-spindle technology to a broader range of applications thanks to a flexible tool slide platform that greatly reduces changeover times. The machine will be featured at Index's global open house held in Reichenbach, Germany on April 21–24, followed by its North American debut in the company's Booth (#338136) at IMTS 2020.

Accommodating up to 32 mm bar stock, the MS32-6 easily handles a wide variety of complex parts, as the machine is equipped with twelve cross slides, with two v-shaped cross slides equipped with X and Z axes located at each spindle position. C and Y axes, together with live tools, can also be implemented to allow for a broad range of machining processes, including off-center drilling, threading, contouring, hobbing and polygonal turning. All of the machines' slides can also be alternatively configured for grooving or drilling.

Each cross slide in the MS32-6 now incorporates Index's patented W-serration locating system that provides  $\mu\text{m}$ -accurate alignment of the tool holder. Coupled with the company's newly developed quick clamping device, tools can be set up off of the machine and then quickly installed, reducing tool change times by 50 percent. Additionally, the machine incorporates the same W-serration system on its live units for drilling, milling and polygonal turning. By presetting tooling for these operations off of the machine, setup times can be reduced by up to 92 percent.



With the updated MS32-6, users can also now apply twin turrets with rigid tools in up to five spindle positions. These hydraulically controlled units can alternate between tools in less than half a second. This enables the efficient use of separate tools for roughing and finishing in the same position. The twin turrets can also be used to reduce tool changes by incorporating duplicate tools, an option that is especially attractive when working with difficult-to-machine materials.

The machine's fluid-cooled spindle drum features six spindles with speeds that are independently controlled to a maximum of 8,000 rpm. This allows optimum cutting data to be applied to each individual cutting process, resulting in superior metal removal rates, surface quality and tool life. Additionally, the machine can be equipped with one or two synchronous spindles, each of which can apply up to six tools for machining the rear end of parts.

**For more information:**

Index Corporation  
Phone: (317) 770-6300  
<https://us.index-traub.com/ms32-6>



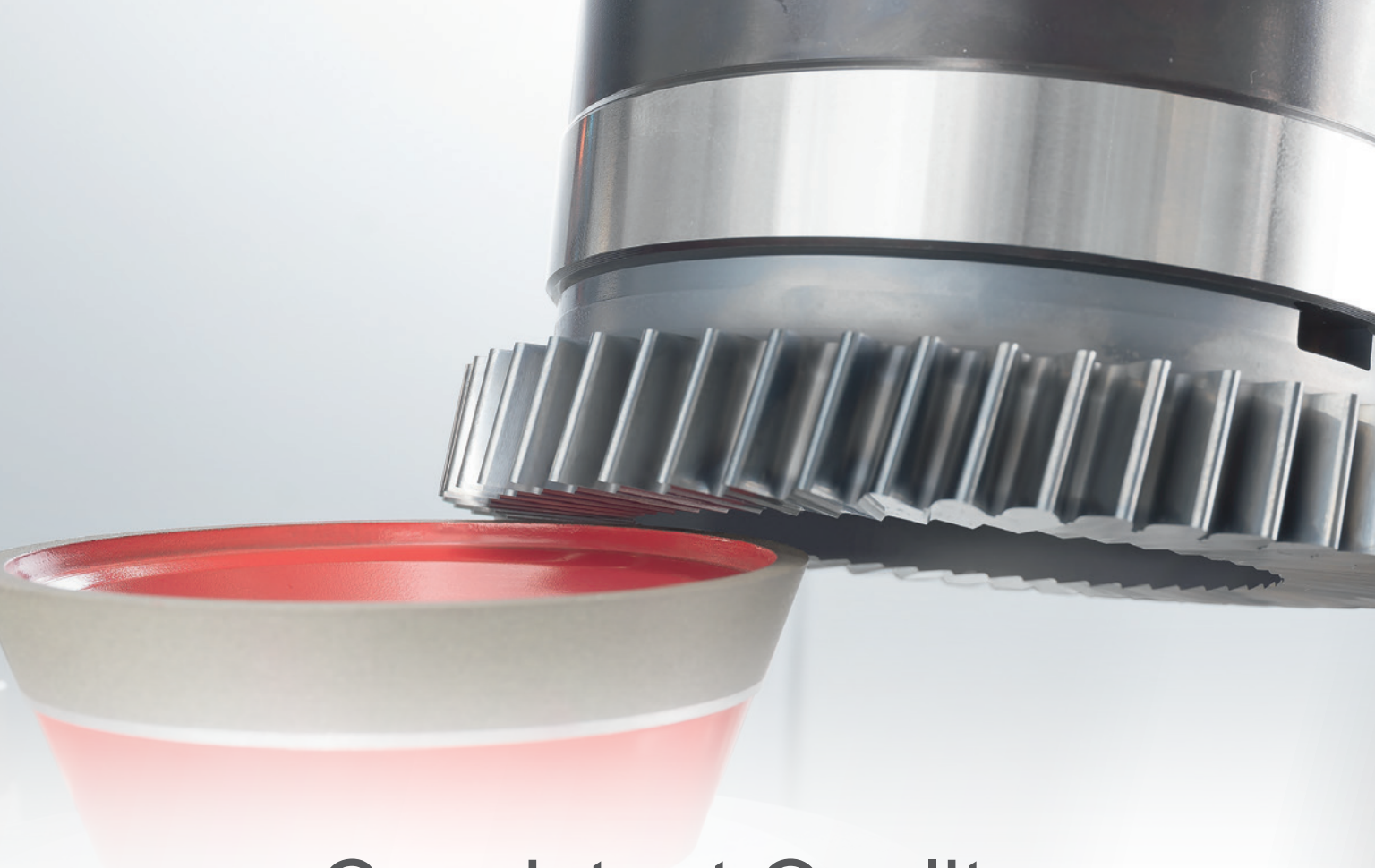

# Consistent Quality with Reduced Cost

Resharpener of cutters for both soft cutting and fine finishing can now be fully automated on Gleason vertical Power Skiving machines, greatly reducing tool cost-per-piece and helping ensure consistently high quality.

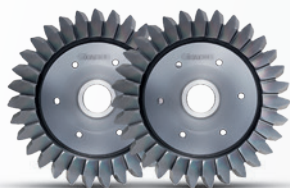

See it  
in Action



Total Gear Solutions

# Gleason

# Dillon Manufacturing

## HARD JAWS FEATURE DIAMOND-SHAPED SERRATIONS

Hard Jaws from Dillon Manufacturing, Inc., feature diamond shaped serrations for increased pull down effect which reduces part slippage and push back from using a bar feeder. The aggressive serrations on the gripping surfaces are also ideal for cast parts, scaly parts or parts with imperfections. Manufactured of 8620 steel and case hardened with precision ground locating surfaces. The jaws are black oxide coated for corrosion resistance. The hard jaws are available in one-step or



two-step sets and are reversible for OD or ID chucking. Only one set is necessary to cover a wide clamping range. Dillon hard jaws are available in standard sizes from stock and in different mounting configurations including serrated, T&G, Acme, and square serrated key types to fit all brands of chucks. Dillon chuck jaws are very versatile with multiple radiuses for both inside and outside clamping making them ideal for any size run. Dillon also offers special or modified hard jaws with industry-best turnaround time, which saves time and money by reducing downtime.

**For more information:**  
 Dillon Manufacturing, Inc.  
 Phone: (800) 428-1133  
[www.dillonmfg.com](http://www.dillonmfg.com)

# NACHI

## Redefining the Science of Cutting Technology

*Best Delivery in the Industry  
for Skiving and Shaper Cutters*



*REVOlutionizing  
Drilling*



*Leading the World in  
Hard Broaching Technology*



**Gear & Round Cutting Tool Divisions**  
 Visit Our Production Facilities ~  
 717 Pushville Rd., Greenwood, IN 46143

317-530-1004 - Gear Tools    317-530-1003 - Round Cutting Tools  
[www.nachiamerica.com](http://www.nachiamerica.com)



# Solar Atmospheres

## COMMISSIONS SCANNING ELECTRON MICROSCOPE

To meet the challenges of the metal treating industry, Solar Atmospheres recently purchased and commissioned a Hitachi smart Scanning Electron Microscope (SEM). The FlexSEM1000 II will allow Solar to meet customer needs, such as strict requirements for low level contamination from carbon, oxygen, and/or nitrogen, post heat treating.

Additionally, the SEM will enable Solar to fulfill materials characterization and microstructural determination requests beyond the basic metallography and hardness testing. This investment is a response to the changing needs of Solar's customers, and is in keeping with the company's mission of looking forward in the area of technical capabilities while demonstrating a willingness to accept a challenge.

"This addition is a game changer," states Don Jordan, vice president of technology at Solar. "We have made significant investments in our technical capabilities over the years, and this was a natural addition to our core competencies." The SEM unit includes an energy dispersive X-ray Spectroscopy (EDS) option in order to characterize the elemental composition of the sample under investigation. "SEM technology has come a long way recently," Jordan continues. "Today's SEM technology means you don't need to be a PhD to run the machine. The human interface is

user-friendly, meaning quick and accurate metallurgical photos and spectroscopy can be achieved."

"SEM analysis is yet another value-added service available to our customer base" states Mike Moyer, director of sales. "Many of our customers have needs over-and-above what commercial heat treat companies offer. Now, not only can we help our customers develop

a complex heat treatment process, but we can provide them with the analytical results to validate that process. It's a one stop shop for them, adding value and reducing the time necessary to bring a process to production."

### For more information:

Solar Atmospheres  
Phone: (215) 721-1502  
[www.solaratm.com](http://www.solaratm.com)



**RINGS** | **DISCS**  
4"-144" OD | UP TO 60"

# EASY DOES IT

## Service. Quality. Speed.

McInnes Rolled Rings believes in providing superior service and outstanding quality products, ensuring the entire sales process is as easy and as fast as possible for our customers.

When it's seamless, it's McInnes.

**McINNES**  
ROLLED RINGS

1.877.695.0280 · [www.McInnesRolledRings.com/Easy](http://www.McInnesRolledRings.com/Easy)

# Tinkering with Carbide

**Everybody's working with carbide tools these days, but carbide materials are expensive. However, these cutting tool companies think they might have some solutions to extend tool life and reduce costs.**

Alex Cannella, Associate Editor

**Whether it's skiving tools or shaper cutters, many of the latest cutting tools that manufacturers have been promoting have all taken advantage of one material: carbide.** From Gleason to Star SU, many of the biggest cutting tool manufacturers have all developed carbide tooling that takes advantage of the material's rigidity and affordability, but gear manufacturers want more, so the challenge is to constantly find ways to improve tool life and tool cost.

It's a matter of juggling priorities. If tool life is the only concern, it's fully possible to improve that metric, but most methods of doing so would unfavorably spike the cost of the tool, trading one problem for another. The trick is to figure out how to improve tool life without raising costs. And regardless of what they're making, the tool manufacturers we spoke to are almost universally working to do that, each working in their own ways to improve their tools.

## Federal Broach: Bridging Two Worlds

Since getting purchased by Mitsubishi Heavy Industries in 2012, Federal Broach has been undergoing a bit of a renaissance. Formerly focused on broaching, the company has expanded to make basically anything—hobs, skiving tools, even a few multilayer coatings.

It's all part of a customer-focused approach. They operate in virtually any industry that needs gears: aerospace, agriculture, automotive, industrial, the list goes on. And whatever customer they get, Federal Broach focuses on getting what they need. That means being able to supply a wide variety of tooling for basically any situation.

"Our big advantage is one-stop shopping here," Ken Kernien, senior tooling engineer at Federal Broach, said. "We build the machines. We build the cutting tools. We supply the automation."

"Now we're looking at 'really, what is the best solution?'" Dan Dennis, CEO of Federal Broach, said. "Does the customer want broaches? Do they already have a broach machine? Do they already have a hob machine? Do they want to go carbide? You have to be looking in every direction today in order to be listening to what the customer wants. You want to steer them in the right direction."

However, this leaves Federal Broach in a unique position bridging two very different worlds of gear manufacturing. On the one hand, they're "as modern a broaching company as you're going to find in America," according to Kernien. But they're also fully invested in developing new tooling in more modern fields, particularly focusing on skiving, the most recent trend to catch on in the industry.

And from that unique view straddling both worlds, Dennis still finds applications for both.

"If you want volume, broaching is the way to go," Dennis said.

Outside of that, however, other machine tools have caught up and supplanted broaching. They're faster, they're drier, and they're cheaper. And in Dennis's experience, cost is where each type of tooling can have a deciding advantage.

On paper, broaching might seem to fall short. It costs more up front to develop and test a broaching tool. But critically, more affordable options like skiving also have a shorter tool life, and if all you're doing is punching out the same part en masse, the cost of resharpening or replacing tools as they break adds up over time. Hence, broaching for volume, alternative options for anything else.

That may not be true forever, however, as one of Federal Broach's most recent offerings, the Super Skiver, is designed to cater towards one of the most volume-intensive industries in the market: automotive.

Much like with other companies' latest cutters, the big innovation with Federal Broach's Super Skiver is an additional cutting edge. Normally, skiving tools have only two, but in the Super Skiver's case, there are two cutting edges for roughing and a third for finishing. The primary benefit of this change, and the reason the Super Skiver is being marketed to automotive gear manufacturers, is longer tool life. With more blades per tool, each individual blade sees less wear and tear, and they all last longer, providing savings and improving the ability to skive in bulk.

"[The third cutting edge] allows you to lighten up the forces, lighten up the work, and ultimately getting a longer tool life," Kernien said.

The Super Skiver is a culmination of Federal Broach's work in both skiving and broaching. Traditionally, skiving tools have often only had a single blade, while broaches have had multiple cutters. And wielding their expertise with the latter helped them to develop the Super Skiver, as well as ensure that they could properly adjust their skiving machines to effectively utilize multi-tooth cutters with tweaks such as adjusting the cutting stroke to allow the cutter to pass all the way through the gear with full clearance on the other side.

"We wanted to look at it more from the broaching side," Kernien said. "How could we combine broaching technology with skiving technology?"

In that sense, Federal Broach not only straddles two very different worlds, but brings the expertise and sensibilities of both together.

## Gleason: Focusing on Flexibility

Gleason, as always, is a fount of new gear tooling innovations. Their latest work runs from straightforward improvements to their bevel tooling to larger, cutting edge Industry 4.0 projects.

Over the past several years, Gleason

**Pentac EcobladeRT cutter head  
(courtesy of Gleason Corporation).**

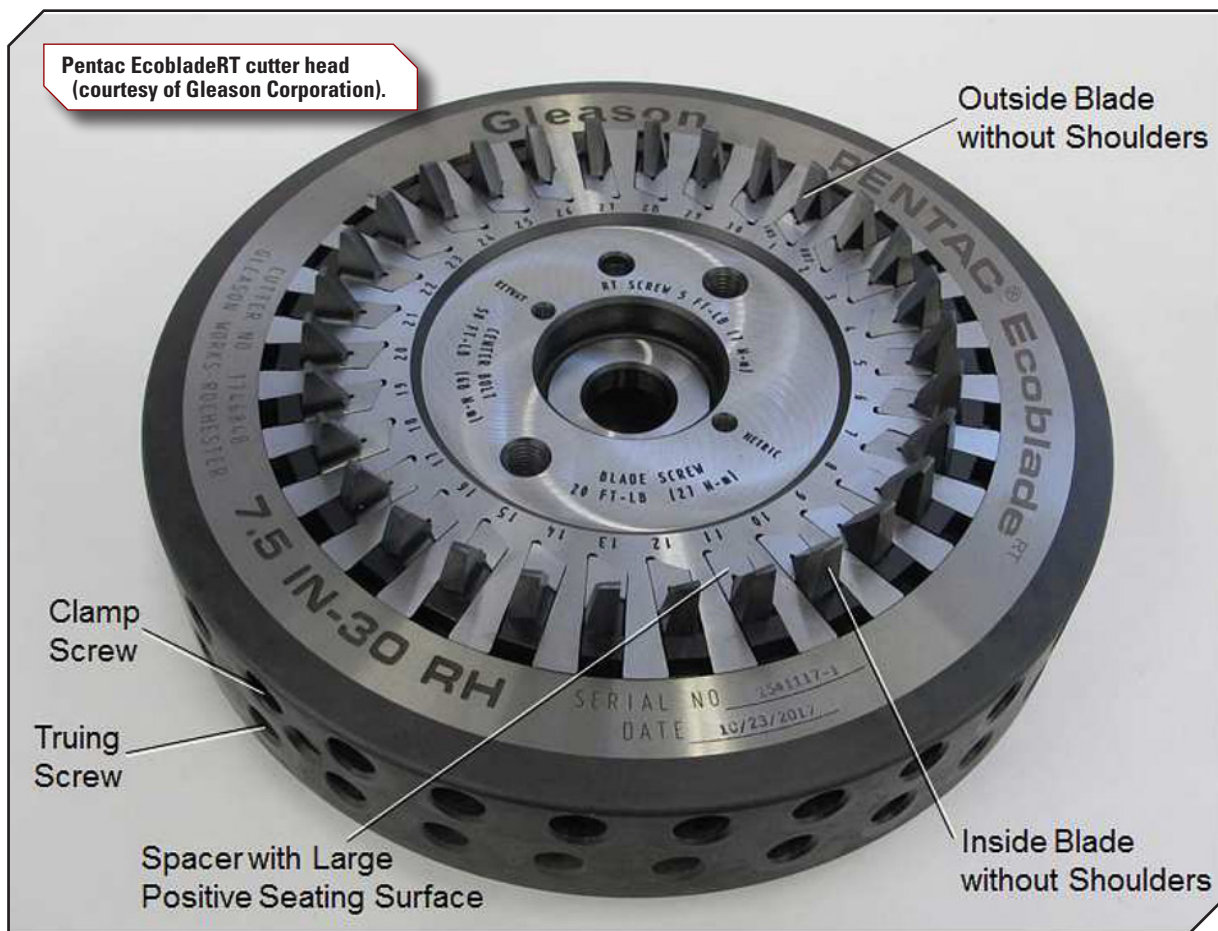

## All The Gear Cutting Tools You Will Ever Need Are Right Here DTR is one of the world's largest producers.

### DTR. Your best choice for high quality gear cutting tools.

DTR is a world class supplier of the finest high performance long-life gear manufacturing tools, for small and large gear cutting applications. Established in 1976, we are one of the world's largest producers of cutting tools, shipping to over 20 countries.

DTR offers a full line of gear cutting tools including:

- Hobs
- Carbide Hobs
- Shaper Cutters
- Milling Cutters
- Chamfering and Deburring Tools
- Broaches
- Master Gears

We can produce virtually any tool you need for auto, aerospace, wind, mining, construction and other industrial gears.

Every tool is precision-made utilizing high speed steel, premium powder metal or carbide and the latest in coatings, to achieve superior cutting and long life. DTR uses top of the line equipment including Reischauer CNC grinders and Klingelnberg CNC sharpeners and inspection equipment.

Learn more about our outstanding quality tools at [www.dtrtool.com](http://www.dtrtool.com).  
Call us at 847-375-8892 for your local sales representative or  
Email [alex@dtrtool.com](mailto:alex@dtrtool.com) for a quotation.



# DTR

**PERFECTION MOVES US**

(formerly Dragon Precision Tools)

[WWW.DTRTOOL.COM](http://WWW.DTRTOOL.COM)

**DTR has sales territories available. Call for more information.**

**U.S. Office Location (Chicago) Email inquiries to: [alex@dtrtool.com](mailto:alex@dtrtool.com).**

1865 Hicks Road, Suite A, Rolling Meadows, IL 60008

**PHONE: 847-375-8892 Fax: 224-220-1311**

Headquarters

85, Namdong-daero 370beon-gil, Namdong-gu, Incheon, Korea, 21635

**PHONE: +82.32.814.1540**

**FAX: +82.32.814.5381**

has been expanding their Pentac line of bevel tooling.

"Gleason has a very long history of bevel cutting tools," Lance Bell, director of sales for USA and Canada at Gleason, said. "And this particular tool, the Pentac, was developed a while ago to create a better seating surface, provide more rigidity, more stability in the cut, which leads to better part quality and higher tool life."

The Gleason Pentac tooling system has been continuously developed and improved over the years, expanding the line with more industry-specific tooling such as the Pentac Plus, Pentac Aero, Pentac RT and now, most recently: the Pentac Ecoblade RT.

The Ecoblade RT System is also designed to tackle one of the stick blade cutter system's primary challenges: its truing capabilities, specifically real truing in both planes, radially and axially.

"To get the right geometry for a large variety of different parts, we would have to make very wide carbide blades to fit within these slots [in the cutting head]," Bell said. "...The bottom line was because of that, there was a lot of wasted carbide. So we're making these really large blades with this smaller portion for the cutting section, and then as you would sharpen them and grind them back, you were grinding back a lot more carbide than was ideal. That made the blades more expensive than necessary, even if the tool cost per part is still on a very competitive level."

Gleason had a bit of a needle to thread here. There was a desire to improve the tool line's truing capabilities and reduce the amount of carbide required to make a blade, but it couldn't come at the cost of the rigidity that was the whole reason for the Pentac line in the first place. And their solution was to add a V-shaped spacer to the Ecoblade's carbide cutter.

This created a few different dynamics. Having a blade that can wedge into the V spacer keeps the tool snug, and importantly, it allowed Gleason to reduce the size of each individual blade, which of course meant a lower cost of materials and a cheaper to produce overall product. Nobody's going to turn their nose up at that. And at the same time, it did indeed solve the stick blade truing challenges.

But above all, the Pentac Ecoblade also offers mechanics expanded flexibility.

"By going this way, customers are able to buy [fewer] different types of heads to cover a broader range of parts that they might have to cut... By using the spacer system, you can cover a wider range of parts," Bell said.

Flexibility in general seems to be a priority at Gleason, a "key factor we're keeping in mind," according to Bell. Not just for job shops that might do a wide variety of different jobs, but also for industries like automotive that are focused on high-volume work.

"Any kind of flexibility that we can create, whether it's in cutting tools, whether it's in workholding or other kinds of tooling, that's going to be beneficial to the customers nowadays. Every customer I know is trying to leverage as much of their technology as possible to be as flexible in their market, as well."

And the Ecoblade isn't the only innovative cutting tool Gleason's developed either. Ease of use and tool cost per piece was also a consideration when developing their first chamfer hobbing system.

The big design challenge that Gleason tried to tackle with its chamfer hobbing was burrs left on a component after the initial cut. Chamfer hobs are designed primarily with the automotive industry in mind, where increasing focus on electric vehicles has also meant increased scrutiny surrounding accuracy and gear noise. With hard finished gears, leaving those little burrs behind after chamfering just isn't an option. When chamfer rolling you'd have to instead reset the machine with different tools to make a second hob pass at the same component, or use a chamfer rolling tool with a burrishing wheel to ensure quality.

But as a clean cutting process, Gleason's chamfer hobs are designed to eliminate that second step by ensuring the burrs never show up to begin with. And when you only have to cut once, you have to spend less time per component and productivity goes up.

On the higher tech end, Gleason's also continued its work in the field of Industry 4.0. In addition to existing projects such as its Closed Loop software system, Gleason Connect, Gleason Fingerprint, and Remote Machine

Maintenance, Gleason's introduced "gTools," a preventive maintenance solution that allows users to both track and study their inventory of cutting tools. It works through RFID chips and data matrix codes personalized for each tool, much like an ID, and track that tool through its entire lifespan.

gTools doesn't just track on-the-job performance metrics like how many cycles a tool has run for, parts it's cut, or its accuracy, but also other major events such as when the tool was last sharpened, and how much material was ground off to do so. And utilizing it can allow a manufacturer to not just predict when a tool might fail, but also understand how well the component's performing, and how you might be able to tweak your machine's settings to improve that performance. And as an additional perk, the RFID chip can also transmit the tool's settings directly to the Gleason machine it's operating on, reducing the risk of user error during setup.

## Star SU: Expanding Applications for Carbide

Star SU, meanwhile, has been following a different trend.

"One of the changes that we're seeing in the marketplace is the use of solid carbide in not only the cutting/power skiving applications, but now we're also seeing it being used in traditional shaping applications," Tom Ware, product manager of gear tools at Star SU, said.

Shaping applications aren't the traditional domain of carbide tools, but according to Ware, it's an increasingly valid option, one made possible not necessarily by improving carbide tools, but in the ways that the machines they operate on are changing.

"The concern had always been previously that carbide was too brittle to hold up under the impact load of a shaping application," Ware said. "But more and more customers are making the adjustments in their machines to make solid carbide shaping cutters a viable alternative to high-speed steel."

Those changes haven't been massive, either. We're not talking about revolutionary sea changes that require you to buy a whole machine, but smaller adjustments in how existing machines are

being programmed — increased stroke rate, reduced rotary feed rate, and any other tactic technicians can think of to create smaller chips during the manufacturing process.

But despite those efforts, carbide's achilles heel still shows up here, as well. As with everyone else wrestling with carbide tools, there's an active effort on improving tool life, but for Star SU, the big focus is on finding a way to do it without ballooning the cost to manufacture them.

"You can imagine when the customer starts with each of their skiving tools, all of them were very into the optics of very low cycle times," Deniz Sari, sales manager for Middle Europe at Star SU, said. "A lot of pieces per day they could produce. But then more and more questions came up. They are not looking to have 20, 40, 60 tools. Is there any way they can improve the tool life dramatically on the existing Scudding technology?"

So how does Star SU go about improving tool life? There are always coatings, such as Oerlikon Balzers' Balanit Altensa aluminum chromium nitrate coating. There are also a number of ways Star SU is improving the cutting tools themselves. In recent years, they've focused on research on improving surface finishing, polishing, and cutting edge conditioning, all of which contribute to longer tool life.

But as Star SU has continued to develop their cutting tools, they've also had to focus on extensive value-added services. The gear manufacturing industry's talent shortage is no secret, but an increasing number of gear cutters are leaning on the expertise of companies like Star SU well after they buy a tool.

"There are also cases out there where customers will only allow [you] to quote if you can agree to offer technical service afterwards," Sari said. "So if you bring the tool, you also have to bring the technology."

This expertise comes in several forms. Sometimes, it's simple, standard services like tool resharpener and recoating. Other times, it can extend to providing training classes in customers' facilities and performing troubleshooting.

"We're becoming their process engineers in many cases," Ware said.

However, Star SU has ultimately rolled

with these industry changes, and according to Sari, the company is happy to perform these additional roles in addition to providing their usual line of tools.

"For us, it's not a huge problem because we chose [to be a] technology leader, as well, and this is why we can work very well with today's environment," Sari said.

## Liebherr: Reducing Delivery Time

Star SU isn't the only company increasingly going above and beyond just providing a quality tool to assist their customers. According to Haider Arroum, team leader of sales for tools at Liebherr, the company has also had to tackle an influx of inexperienced customers. They don't just have to contend with the industry's talent shortage, but also new customers that previously outsourced their gear work to specialists, but now



**Gearing your past to power your future.**

**Breakdown Services**  
We understand the urgency of meeting critical deadlines. We offer our customers expedited services without sacrificing quality.

**Heat Treatment**  
Our in-house heat treat facility performs a full range of services that include annealing, carburizing, and thru hardening.

**B&R**  
MACHINE AND GEAR CORP.

B&R Machine and Gear Corporation is a full service gear manufacturing facility driven to power your equipment with reliable and durable gears that are built to perform and last. Find the perfect mesh. No matter the gear, we've got you covered.

VISIT OUR WEBSITE [BRGEAR.COM](http://BRGEAR.COM) FOR MORE INFORMATION

want to do that work in-house. Gear manufacturing, however, isn't a process that one can just pick up and start doing on a whim — it takes expertise, and companies like Liebherr are the ones that have to provide it.

In order to provide that expertise and properly guide these companies to the best cutting tool for them, Liebherr has a clear picture of their customers, and they have a wide range of tools they can guide those customers to.

Some of their most recent products, of course, are also in the field of carbide materials and skiving. In particular, Liebherr has focused on what they call cubic skiving. And according to Arroum, Liebherr finds themselves in a unique position to leverage their expertise as a turnkey provider to further their work in this field.

"We have machines, we have tools, and we have the technology," Arroum said. "...We are playing with these three factors to reach a stable process — so good quality, fast production, and also tool life."



**Liebherr offers a comprehensive range of gear tools, many years of experience in gear manufacturing and maximum product quality.**

Here, however, Liebherr differs a bit from other companies. While tool life is certainly a selling point, Liebherr's eye is primarily on maintaining affordability and improving delivery time.

"Nowadays, we see that our customers are more asking about delivery time,"

Arroum said. "So the supply has to be fast. Quality is mandatory. Nobody is talking about quality today. Tool life is also something which is expected...But the challenge will be fast deliveries and price."

Liebherr's been doing plenty of work

**No Money for Capital Equipment Purchases? NO PROBLEM!**

**REPOWER**



SIGMA 3

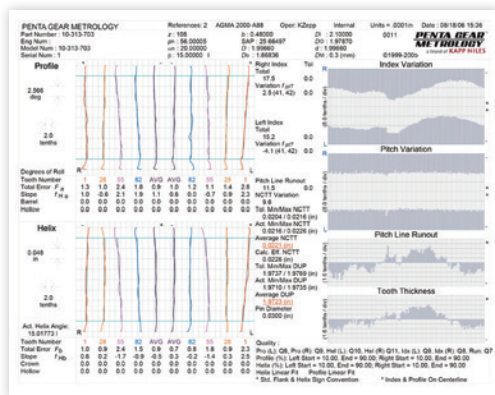

M&M 3025

- REPOWERED BY Penta Gear**
- Analytical Inspection Machine
  - Roll Testers
  - Single Flank
  - DOB Inspection Gauges

**PENTA GEAR METROLOGY**  
a brand of **KAPP NILES**



outside of their skiving line as well, however. They've recently changed the material of their immediately available stock tools from SP2030 to SP2052 — and use Alcrona coating on those tools to boot — in a bid to improve how well they work with stiffer materials. The harder SP2052 will allow these shaping tools to be used in industries such as aerospace that work with harder materials and demand higher quality components.

That demand for higher quality is driving other moves at the company, as well. Liebherr continues to focus on developing closed loop manufacturing systems. They're not just focusing on closed loop production for one or two tool lines, but trying to build it up for every kind of tool they sell. That means not just skiving, but also other products like CBN grinding wheels.

According to Arroum, it's a required move necessitated by quality expectations from customers.

"Each micron has to be at the right place," Arroum said. "You must work with closed loop. There's no other chance."

Quality may be expected as a matter of course, but the goalpost of that expectation is always moving. When shifts in the industry such as automotive's focus on electric vehicles and gear noise are met by an also ever-improving ability to detect imperfections, adopting new processes like closed loop manufacturing are what keep Liebherr ahead of the curve. And one of the best ways to maintain that high level of quality is to remove the risk of human error, one of closed loop manufacturing's biggest and most oft-touted selling points.

While Liebherr might not have a brand new shiny cutting tool line to raise eyebrows and draw headlines, it hasn't meant that the company has been idle. As the company works on all of these different projects to incrementally improve the quality of the products they already do have, Liebherr is still driving innovation in the field. 

**For more information:**

Federal Broach  
(989) 539-7420  
[www.federalbroach.com](http://www.federalbroach.com)

Gleason  
(815) 262-6534  
[www.gleason.com](http://www.gleason.com)

Liebherr  
+49 (7243) 708-673  
[www.liebherr.com](http://www.liebherr.com)

Star SU  
(847) 649-1450  
[www.star-su.com](http://www.star-su.com)



**MACHINE SOLUTIONS THAT ARE**

# GOOD AS GOLD

- REBUILDS, RETROFITS & RECONTROLS
- MACHINERY REPAIR, MAINTENANCE & PARTS
- CUSTOM BUILDS, TOOLING, SOFTWARE & CONTROLS
- ENGINEERING, TRAINING & CONSULTING
- NEW & PRE-OWNED GEAR CUTTING, GRINDING & INSPECTION EQUIPMENT



**BEFORE** **AFTER**



**MACHINE TOOL BUILDERS**  
*Industry-Leading Experts  
World-Class Technologies*





**MachineToolBuilders.com**  
**815.636.7502**

# Real-Time Measurement Opportunities

Matthew Jaster, Senior Editor

**Shop floor inspection and gaging equipment is putting advanced metrology systems right on the factory floor. Here's a collection of articles on shop floor inspection and gages from companies like Gleason, Mahr, Comtorgage, United Tool Supply and Frenco.**

## Changing the Paradigm for Shop Floor Inspection with Gleason

For today's gear manufacturers, nothing is more frustrating, or costly, than a shop floor 'bottleneck'. Waiting for inspection results from the lab can bring production to a standstill. Yet, growing low noise requirements, increased power density, greater reliability, and other demands have made gears more complex and inspection requirements more critical than ever. Here's how two new Gleason inspection technologies are meeting these challenges and adding significant value to shop floor inspection.

### GMSP: Bringing the Lab to the Shop Floor

The Gleason 300GMSP Analytical Gear Inspection System operates just as reliably in most shop floor environments as it would in a tightly controlled lab environment. Manufacturers can now

put this advanced metrology system in close proximity to their production machines, and finally eliminate both the wasted time needed to transport finished gears to the lab and the additional time needed for parts to work their way through the queue.

While the GMSP delivers all the same capabilities and functionality as the other systems in Gleason's GMS series, it features a completely new 'shop hardened' design that makes it impervious to the significant temperature, vibration and contamination variations common to the factory floor. A proprietary machine base material is used that's better suited than the typical granite for the sustained higher temperatures of the shop floor. The use of this new base material, coupled with a completely new patented 'H' base design with active leveling system, has proven to be an excellent solution. The new base design consists of a bottom base with four air springs mounted on risers, which support the machine work platform. These air springs detect, and automatically compensate for, vibratory forces on the fly, such that the machine work platform (axes, table and workpiece) is both isolated from and immune to vibration seen in typical gear production environments.

The high precision guidance systems

used to position linear and rotary axes on most inspection systems are inherently susceptible to even minor temperature changes. The use of enclosed glass scales ensures exceptional accuracies, but also come with a thermal co-efficient. The GMSP addresses this as well, with a new type of scale made from a material that has essentially zero thermal expansion within the typical shop floor temperature range. While scales of this material type must be left open rather than enclosed, they are exceptionally resistant to dirt. In addition, the GMSP's new design helps mitigate the collection of particulates that can build up on scale surfaces and reduce accuracy and reliability.

The GMSP also incorporates a system of new software and sensors that work in combination to detect, and compensate for, typical thermal fluctuations found on the shop floor. This ability to identify and apply compensation for factory floor temperature influences in real-time contributes greatly to GMSP's exceptional accuracies in an uncontrolled temperature environment.

Like all the GMS series products, the GMSP features GAMA 3, Gleason's object-oriented Windows 10 compatible operating software that puts a host of features right at the operator's fingertips, creating a simple, intuitive human/machine interface. With GAMA 3, creating a new program is as easy as point and click, and can be done in a few easy steps regardless of experience level, language requirements or the gear or application type.

Most importantly, GAMA supports multiple analysis tools to help identify the root cause of gear noise, including Fourier analysis of bearing surfaces, tooth contact analysis, surface finish analysis and easy interface with KTEPS software.

With GAMA 3, VDI/VDE 2610 GDE (Gear Data Exchange) capability is standard, reducing the need for redundant programming and allowing gear data/parameters to be easily transportable between different machines. The GMSP is easily networked with Gleason



**GMSP models deliver lab-level inspection right on the production floor, saving the time usually required for part transport and lab room queues.**

production machines in a Closed Loop, so program corrections can be made at the machine tool real time.

### **GRSL: In-Process Gear Inspection at Light Speeds**

On the other end of the production spectrum, where transmission gears are being produced in high volumes and inspection of every gear in-process is increasingly desirable, Gleason offers its new GRSL Gear Rolling System with non-contact laser inspection. GRSL combines the latest non-contact gear analytical measurement innovation with the tried-and-true double flank roll test gear inspection process used today in most high-volume gear production where 100% inspection is required. This new product follows the strategy of the recently introduced multi-purpose GMSL non-contact inspection system from Gleason. Where the GMSL was developed to exceed the requirements of today's most stringent gear processing research, development and reverse engineering needs, the GRSL brings high accuracy, high speed, non-contact measurement of gears in-process to the high-volume production environment, where performance expectations have never been higher.

The new GRSL product stays true to the strategy Gleason's partner customers continue to ask for. It adds value by adding measuring capability with multiple sensors on a common platform to reduce cost of ownership, the number of operators required and the footprint. In addition, it adds throughput by measuring both the composite, functional error and the individual part characteristics of involute, index and lead, simultaneously during the same revolution of the gear during the test cycle.

### **Single Platform, Exciting Possibilities**

This patent pending, dual purpose inspection system provides additional value by offering the versatile GRSL platform in three different configurations for use as a stand-alone manual gage, a semi-automatic gage or even as a fully automated gage where high volume throughput is the priority. Tests for full analytical results of both involute and index are performed on all teeth for

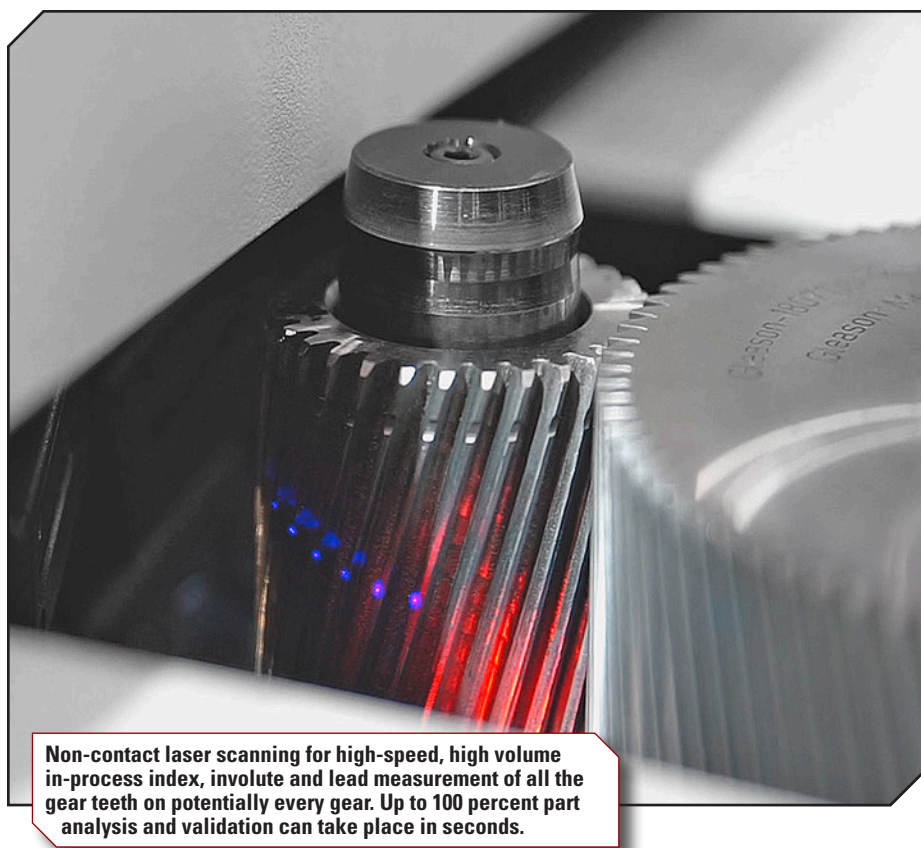

**Non-contact laser scanning for high-speed, high volume in-process index, involute and lead measurement of all the gear teeth on potentially every gear. Up to 100 percent part analysis and validation can take place in seconds.**

most external, cylindrical gears up to 250 mm diameter in a matter of seconds along with the composite double flank roll test, again, with both tests taking place simultaneously.

With the new GRSL, the power of high-speed involute, index and lead measurements also comes with the ability to integrate with Gleason's GAMA gear analysis and charting output. This means options for AGMA, DIN, ISO as well as OEM specific analysis are available for the measurements, with common charting typical of the entire GMS line of analytical machines.

Consider the process control possibilities of full, high speed involute, index and lead measurement in process, inline. Add to that the ability to network this data in a Closed Loop directly to the machine tool using Gleason Connect to communicate results that can assist in determining necessary changes to the machine tool, the cutting tool, part setup, etc.

Taken a step further, GRSL can now be fully integrated into Gleason's new Hard Finishing Cell (HFC), the Closed Loop manufacturing system to produce precision gears in medium and high volumes. The system includes revolution-ary in-line gear checking with real-time

analysis and automatic feedback of corrections to a Gleason 260GX Threaded Wheel Grinding Machine, as well as integration of modules for auxiliary processes such as part washing and marking. Parts handling throughout the process is fully automated using high-speed robot and pallet system.

All of this is now available, fully integrated with the traditional double flank roll, composite testing still called out on most part prints today in high volume gear production.

### **Noise Analysis: In-Process, On the Shop Floor**

The possibilities are exciting to think about and the capabilities continue to grow. Along with analytical measurements of gear parameters being measured in process in a matter of seconds, the same data acquired during the all teeth measurement can be analyzed using Gleason's analysis for noise characteristics seen in gears before they are assembled with a mating gear into a gearbox. Tolerances tied to these values can be monitored and controlled in more advanced, quantifiable methods than just go/no-go audio measurements shown in traditional single flank and end of line testers used today. The

value in predicting noise characteristics before the gear is ever assembled with a mating gear, a master gear or worse case in the gearbox itself is significant. It reduces the need for hard masters, a perishable component that needs certified and replaced regularly. It eliminates the need to tear down a finished gearbox to replace or rework gears tied to the noise. The new GRSL technology when added with Gleason's noise analysis reduces both gear lab space requirements and the use of analytical gear inspection machines, since GRSL operates on the shop floor and can do the work of multiple inspection systems by measuring in process. It minimizes the need for single flank testers and other end-of-line testers with the noise analysis data it provides. It also reduces gearbox teardown and gear rework chasing gear noise. The GRSL also offers the flexibility of operating the analytical and composite, double flank tests independent of one another if desired. This can offer advantages such as extending the life of the master gear if, for example, it is determined that not all parts require double flank composite testing. The power and flexibility of this new technology continues to grow.

**For more information:**

Gleason Corporation  
 Phone: (585) 473-1000  
[www.gleason.com](http://www.gleason.com)

**Gear Gages Go Integrated Wireless**

**George Schuetz, Mahr Inc.**

Gears are an important element of mechanical designs. However, they are often taken for granted despite their many life and death implications. In fact, gears are used in so many applications and with so many different performance requirements that one can get lost in the principle design functions - including how a gear is assembled to a matching part, how it performs under different conditions, and the strength of its components.

There is a very complex science behind gears and equally complex measuring systems available to discover virtually every imaginable piece of information about them. However, most gaging used for interim gear qualification on a shop floor is based on the gear being made from a basic cylindrical shaft or hole. From this, verification usually comes down to a few critical dimensions that can be measured and certified by measuring a related inside or outside diameter.

Thus, on a straight gear, the two common checks that need to be inspected are the parts' major diameter and diameter over balls/wires. Historically, basic inside diameter (ID) and outside diameter (OD) gages have been modified with special contacts to allow inspection of these important gear parameters. For example, the basic snap gage with dial indicator has become a diameter over ball gage using custom contacts. Since dial indicators and gages were developed some 100 years ago, basic dial indicator gages have been used to control important gear parameters.

Around 50 years ago, the manufacturing world began collecting measurement data. Through tables, charts and graphs, measurements were made and used to help document quality or used as process control to help prevent bad parts from being used.

About 30 years ago, data collection for process control took a major leap forward. This happened as a combination of electronic technology and economics enabled digital gaging. With a digital signal available, it became possible to transfer information via cable directly from a gage or digital indicator to the data collector. This made it much more practical to make process control decisions based on statistical analysis.

Electronic data collection also ushered in a major improvement in data quality.

**Today's digital indicators have data output built in, and collecting data is easy and very cost-effective.**



**Data can be stored for long-term archiving, recording when the part was measured and by whom. It can also be used for tracking and improving operator throughput.**

Previously, data was either handwritten on a sheet of paper and then logged into a computer, or it was logged into the computer directly at the point of gaging. One can easily understand how an operator, sitting at a bench measuring hundreds of parts, could transpose numbers, skip digits, or simply enter incorrect numbers. These problems were virtually eliminated by importing data directly to data analysis software. In fact, when electronic data collection strategies were first implemented, it was not unusual to see ten-fold improvements in collection efficiencies and error reductions compared with manual collection methods.

These days, checking gear parts at a gaging station with a dedicated fixture gage connected to a computer via a cable for data collection is the norm. Today's digital indicators have data output built in, and collecting data is easy and very cost-effective. It is also fast and reliable and provides a great solution for many process or quality control applications.

But whether using just one digital indicator or multiple digital indicators on one gaging fixture, cable clutter soon became an issue. Each digital indicator would typically have its own cable, and since there are so many, some type of interface box was required to handle the multiplexing of the signals to the computer. With the integration of the transmitter in the digital indicator, both the cabling and the multiplexers are eliminated — not to mention a cleaner





looking gaging station. The PC running the data collection software can be triggered by the operator to gather the data from multiple digital indicators.

Eliminating cables is great, but probably the best application for this technology is right at the machine tool. Rather than store the data only to document that the part was measured and whether it was good or bad, the information can be better utilized. By transmitting wirelessly into the machine tool's controller, the data can be used in the calculation for offsetting. Thus, as the operator measures the parts, the data is used to assign the proper offsets, greatly improving the quality and throughput of the machine tool. Out-of-spec parts are virtually eliminated, and the machine's ability to make parts to the desired dimension is greatly improved.

At the same time, the data can be stored for long-term archiving, recording when the part was measured and by whom. It can also be used for tracking and improving operator throughput.

Today the combination of digital gaging for accurate shop floor measurement, unrestricted wireless transmission of reliable data, and statistics for process control allow for truly effective use of measurement data.

**For more information:**  
Mahr Inc.  
Phone: (401) 784-3100  
[www.mahr.com](http://www.mahr.com)

**HY-TECH**  
ENGINEERED SOLUTIONS

**POWER TRANSMISSION GROUP**

## Custom Power Transmission Products

From Turnkey Solutions to Custom Gears and Gearboxes



- Straight Bevel & Angular Straight Bevel Gears
- Spiral Bevel & Hypoid Spiral Bevel Gears
- Spur/Helical/Worm Gear Cutting
- Spur Shaping
- Thread Milling
- Racks
- O.D. Grinding
- I.D. Grinding
- Centerless Grinding

[www.powertransmissiongroup.com](http://www.powertransmissiongroup.com)  
[www.ptgears.com](http://www.ptgears.com) / (814) 938-5552

**HY-TECH**  
ENGINEERED SOLUTIONS

# 60 Years Proven

ROBOTICS • AEROSPACE • DEFENSE • TRANSPORTATION • MEDICAL

When high torque machine failure is not an option, they call on Spiroid.



**SPIROID**  
HIGH TORQUE GEARING

Spiroid's skew-axis, high torque gears enable world-class power density in a small footprint.

Visit online to learn more. [SpiroidGearing.com](http://SpiroidGearing.com)

## Comtorgage Offers Gages for Specific Gear Applications

Comtorgage Corporation is a manufacturer of handheld, indicating gages for the measurement of bores, grooves, keyways, recesses, threads and a variety of gages specifically designed for the gear and spline industry. The gages are rugged enough for use on the shop floor, at the machine, or in the gage lab.

Monitoring a gear generating or spline cutting operation, whether it be shaped, broached, milled, hobbled, or rolled, requires periodic measurements of various characteristics of the part. In addition to an analytical check, a good way to keep track of the process is to periodically check the 'Measurement Between/Over Pins'. Maintaining this dimension within allowed tolerance will provide a certain amount of confidence in the process (except for index, lead, and profile errors).

Each Comtor-Spline Gage is made for a specific application. The gage incorporates two AGD gage pins of the same size as specified on the part print. The pins are allowed to "float" to compensate for minor misalignment or variations in tooth spacing. Mastering of the gage can be accomplished with a simple Cylindrical Master Ring or with a Sector master, if required. Measurement results can be monitored via Analog Amplifier (as shown in photo #1) or with a Digital Indicator (as shown in photo#2). Where required, the gage can be equipped with flattened pins to insure no interference



Measurements can be monitored via a Digital Indicator.

with the Major Diameter. To ensure that the gage is designed correctly for the application, complete spline data is required, along with a part print showing where the spline is in the part.

Figure 1 shows three different gages, each for the 'Measurement Between Pins' dimension (based on Spline Data shown on the part prints) provided by the end users. One of the smaller gages includes a depth stop to allow the measurement to take place at a specific location within the spline. The measurement is not a 'line contact' with the entire pin locating in the tooth space. Actual contact takes place at the very tip of the gage pins, which allows for detection of any taper that may be present.

The example in the Figure 2 shows the Snap Spline design used for

measurement of external splines and spur gears. In this case, the AGD gage pins are held between brackets and again allowed to float. The lower arm retracts to allow the positioning of the gage into the spline or gear teeth spaces. Mastering of the gage can be accomplished with a simple Master Block or with a Sector master, if required.

### For more information:

Comtorgage Corporation  
Phone: (401) 765-0900  
[comtorgage.com](http://comtorgage.com)

## Freco Examines International Spline Interface Standard for Ebike Manufacturing

The inspection method described in the International Spline Interface Standard (ISIS), uses a ring gage with two steps on the front side. This ring gage shows Go and Nogo situations in one gage. The decisive factor is the position of the shoulder on the ISIS shaft. The location of this shoulder must be within a range of 1.70 mm after the gage stops on the shaft. Thus, the Go situation is achieved (Go Range).

If the male shoulder on the spindle touches the lowest surface No Go (minimum surface on the ring gage), the spindle is too small (undersize). If the male shoulder on the spindle is above the top surface No Go (maximum surface of the ring gage), the spindle is out of tolerance (oversize).

### ISIS Difficulty

If a dimension over balls is too small in section A-A for example, it will not be recognized with the ISIS gage concept. Unknown scrapped parts could be

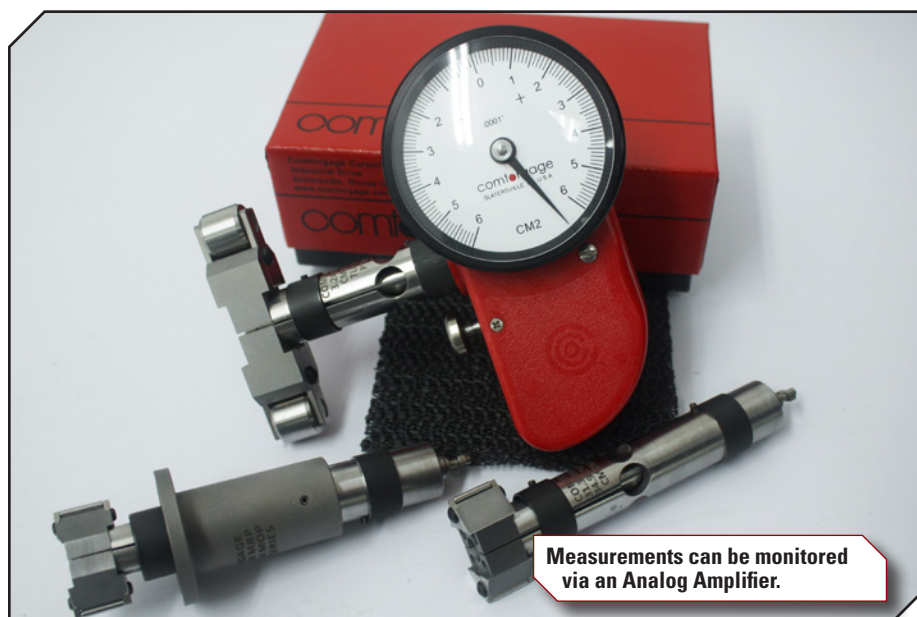

Measurements can be monitored via an Analog Amplifier.

in circulation. The decisive factor is the position of the shoulder (male shoulder). Obviously, there are shafts manufactured without shoulders. In this case, the ISIS concept cannot be used anyway.

*Frenco ISIS Inspection Concept*

The limits minimum and maximum will be checked separately in this concept. This means as already known in the machining element splines, that a full composite profiled Go ring gage for max. effective and a sector profiled Nogo gage for min actual will be used. This Nogo gage can figure out shafts which are too small.

A shaft with a male shoulder must fit in the Go ring gage so far, that the shoulder touches the front side of the ring gage. Shafts without this shoulder will be considered to the front surface of the shaft. The front side of the shaft must be in contact with the internal located stop in the Go ring gage. If the shaft reaches this stop, it can be clearly recognized with a sound.

The sector profiled Nogo gage is designed accordingly, so that it can be set on the shaft, and the front side of the



shaft must not exceed the end surface of the Nogo ring gage.

As an alternative inspection method instead of the Nogo ring gage, a Frenco indicating inspection device type AVMF 1x1 can be used. With this, a dimension over two balls can be inspected in level A-A or B-B, too. During production, a range of different sizes can be observed and controlled. The smallest dimension over balls is the min limit which is not allowed to fall below. A setting master right on this min limit is available and

the dial indicator can be adjusted to zero with this setting master. By inspection of a shaft, it is not allowed to fall below this min limit. Therefore, the handling is very easy with this indicating gage.

**For more information:**

Euro-Tech Corporation  
Phone: (262) 781-6777  
[www.eurotechcorp.com](http://www.eurotechcorp.com)

For Related Articles Search

gages

at [www.geartechnology.com](http://www.geartechnology.com)

# MASTA 10

NEXT GENERATION CAE SOFTWARE FOR THE DESIGN, ANALYSIS AND OPTIMISATION OF TRANSMISSION SYSTEMS



DESIGN



ANALYSE



OPTIMISE

- Design gearbox and driveline systems from clean sheet or imported concepts
- Run and generate reports on a wide variety of analyses including static deflections, durability, efficiency, frequency domain NVH, time domain dynamics and more

Discover more at [www.smartmt.com/masta](http://www.smartmt.com/masta)

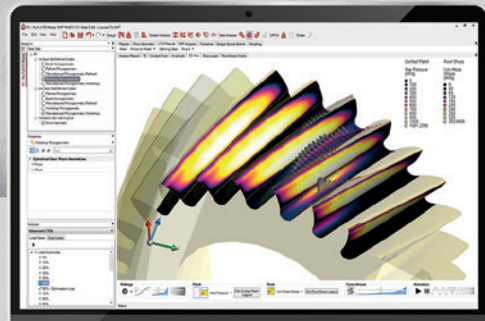

Globally integrated leader in mechanical transmission engineering services and software development

© 2020 Smart Manufacturing Technology



## United Tool Supply Offers Diverse Range of Gear Inspection Equipment

United Tool Supply developed a bench top gage for 20 mm–75 mm internal spline inspection, called the Unite-A-Matic Model 2020.

“This was a natural fit for us as it fell within our Unite-A-Matic product line. Knowing what else the industry was asking for, we continued to explore other opportunities for growth. With a new mindset to “own the gage bench” we set off to develop a product line for a shop hardened surface finish gage and a shop hardened PD runout gage. This led to the birth of our Surf-A-Matic surface finish gage and our Roll-A-Matic PD runout gage,” said Curtis Criswell, director of operations, United Tool Supply.

The Unite-A-Matic Model 2020 features  $\pm 0.001$  mm repeatability, a sealed digital readout system with inch/metric capabilities, cushioned gage head for consistent gaging between operators, roller bearing platen locator, interchangeable 2020 O.D. ball, pin or specialty anvils, interchangeable 2020 platen locators and a setting master can be provided. Options include output port for data collection, wireless data collection, and a stand on roller bearing wheels with storage drawer.

The Roll-A-Matic Model 8800 offers a flexible design to accommodate multiple parts, it's able to use existing masters, SPC capable, simple to use design, manual and servo-driven models, stand with roller bearing wheel and storage drawer and custom builds are also available.

The Surf-A-Matic Model 1000 features protective stylus housing, a universal design to accommodate multiple parts, interchangeable tooling, SPC capability, an accessible and removable controller, vibration dampening feet and custom builds are also available. 

### For more information:

United Tool Supply  
Phone: (517) 752-6000  
[www.united-tool.com](http://www.united-tool.com)

## A Change in Processes and Positions at United Tool Supply

United Tool Supply started as an industrial supply business and transformed seemingly overnight in the mid-80s to a manufacturing company with the birth of the Unite-A-Matic PD inspection gage. The original Unite-A-Matic OD DOB gage evolved into an ID model and a bench top model for OD gear inspection. These three models sustained the business from the mid-80s through the first decade and a half of the 2000s.

By 2015, the company was down to four employees, and had lost touch with many engineers and key contacts as restructuring took place over the years. The customer base was shrinking, and the company was not selling the amount of new product it had in the past.

“The odds were stacked against us day in and day out, but day in and day out, we showed up and we worked hard,” said Curtis Criswell, director of operations, United Tool Supply.

At its height, United Tool Supply was selling over 100+ new gages a year and touted dozens of employees. It was seemingly unfathomable to imagine how a company went from sustaining a livelihood for so many families turn into a shell of what it once was.

“Our conference room had the same blood red carpet from the ‘70s when our facility was built. The conference room turned into an oversized storage closet. Our manufacturing shop was cluttered, full of antiquated machines, and memories of what use to be,” Criswell added.

They took on the painstaking process of a cosmetic overhaul. The blood red carpet was replaced with a neutral blue. Down came the storage shelves that had archived the company's history for decades. The old drafting tables were replaced with new computers and software.

“This was a difficult time. A company so proud of its roots. At times, too proud to make a change. As the saying goes, ‘if it isn't broke, don't fix it.’ Truth is, the business model was broken, and it was left for us to fix,” Criswell said.

United Tool Supply began to sort and separate good vs bad inventory, reorganizing the organization in ways that made more sense. Machine component inventory was labeled and stored accordingly, a workflow process was created, and efficiencies were gained. In came new CNC equipment, out went multiple machines with each replacement.

“Not only did we bring in new equipment, but we now keep work in-house that was contracted out in the past. What took weeks now takes days,” Criswell added.

Product innovation has been key for the company's success. While the Unite-A-Matic PD gage built the business, it is now other products that will grow the business now and in the future.

“We are creating strategic partnerships to support our customers in any way possible, including prototype gears and technical staffing,” Criswell said. “Those reading this may think ‘United Tool is doing what now?’ And to that question I want to remind the reader to call back to the story presented before them. United Tool Supply is a company that was never meant to be, building a product that had never existed previously, in an environment originally meant to store inventory. The odds continue to stack against us, but who doesn't love an underdog story?” 







## RESIDUAL STRESS MEASUREMENT

State-of-the-art facilities *and* superior service.

No compromises.



[www.protoxrd.com](http://www.protoxrd.com)

1-734-946-0974  
[info@protoxrd.com](mailto:info@protoxrd.com)

**PROTO**  
 X-RAY DIFFRACTION

## Dillon Chuck Jaws



CHUCK JAWS



HARD JAWS



JAW NUTS



FULLGRIP JAWS



CUSTOM JAWS

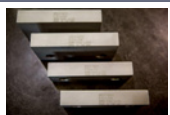

WISE JAWS



JAW BORING RING



JAW FORCE GAGE



CHUCK GREASE



COLLECT PADS & COLLECT JAWS

**Dillon Manufacturing, Inc.**  
 2115 Progress Drive,  
 Springfield, Ohio 45505

ISO 9001:2015 - Sold through distributors

**P** 800.428.1133

**F** 800.634.6480

**dillonmfg.com**

**sales4@dillonmfg.com**

**oelheld**  
 innovative fluid technology

**DiaGrind series**  
 Shift your production into high gear with oelheld **grinding fluids!**

oelheld U.S., Inc.  
 innovative fluid technology  
 Phone: +1-847-531-8501  
[www.oelheld.com](http://www.oelheld.com)

# The Power of One<sup>2</sup>

## Your Objective:

One face in perfect alignment with another. *For infinity.*

## No problems. No distress. No delays.

That's the same objective you have for choosing your gear producer. Circle Gear's objective is to engage with every customer's objectives.

- ▶ One to 1000 gears
- ▶ Customer designed or reverse engineered
- ▶ Gearbox repair, rebuild or redesign
- ▶ OEM or end-users
- ▶ ISO 9001:2015 Certified

1501 S. 55th Court, Cicero, IL 60804  
 (800) 637-9335  
 (708) 652-1000 / Fax: (708) 652-1100  
 sales@circlegear.com  
 www.circlegear.com



Spiral and Straight Bevel Gears (*Cut, Ground or Lapped*) • Spur Gears • Helical Gears • Long Shafts • Herringbone Gears • Involute and Straight Sided Splines • Internal Gears • Worm and Worm Gears • Racks • Sprockets • ISO Certified



Partnering with QualityReducer to provide Gearbox repair, rebuilding and reverse-engineering.

## WE'RE CERTIFIABLE

Our ISO 17025 A2LA Laboratory is available to certify or recertify your Master Gears and Spline Gauges or Contract Inspection of your gears.

Our rapid turn-around service minimizes the "out of service" time.



**PENTA GEAR METROLOGY**

6161 Webster Street, Dayton, Ohio 45414

937-660-8182  
 sales@pentagear.com  
 www.gearinspection.com



**BROACHING MACHINE SPECIALTIES, MDL. CELL-MATE BMCM-1554 15 TON x 54" TABLE-UP HYDRAULIC INTERNAL BROACHING MACHINE, New 2012**

## Orca Machine Tools, Inc.

6551 Jansen Ave NE, Suite 203  
 Albertville, MN 55301

763-494-9825

www.orca-inc.com

Introducing the  
**NEW GEARBOX GENERATION**

Licensing Available

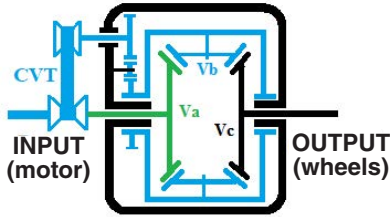

The 2 CHANNEL TRANSMISSION combines a differential with a CVT

**NO MORE SWITCHING GEARS!**

- Cheaper to build
- Motor running - all the time at the speed of maximum efficiency
- Very high torque at low speed
- Less pollution

The new gearbox generation opens the door to new markets.

Cars • Farm machinery • Trucks • Pumping stations • Wind turbines and many more.

[2ChannelTransmission.com](http://2ChannelTransmission.com)  
[sixal@mindspring.com](mailto:sixal@mindspring.com)

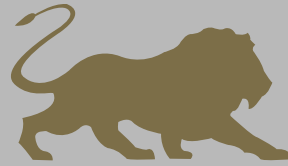

**HobSource Inc**

Custom gear cutting tools

**Performance  
Dependability  
Value**

**866.HOB.TOOL**

[www.hobsource.com](http://www.hobsource.com)



 **Gear Research Institute**

**2020**  
**NEW YEAR,  
BETTER  
GEARS!**

*Gear Research and  
Testing Specialists*

Aaron Isaacson

(p) 814-865-5832

(e) [aci101@arl.psu.edu](mailto:aci101@arl.psu.edu)

**gearresearch.org**

An ASME, AGMA Institute at Penn State

Sign up for our free newsletter or visit our employment opportunities page today!



**PennState**

Applied Research Laboratory

**Gears for the  
toughest machines  
on earth.**

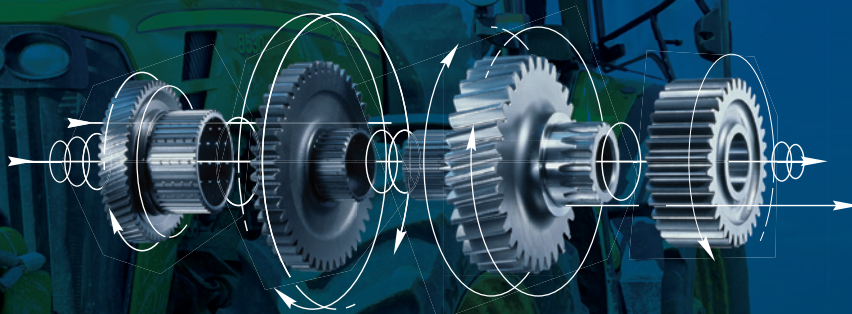

**Together, we are the force  
that moves the world.**

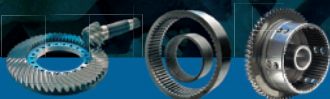

We offer a wide variety of manufacturing capabilities covering almost the entire powertrain and driveline applications.

We make available one of the widest production capability for custom gears for heavy duty vehicles of the entire industry to enable our O.E.M. Customers to focus more on their projects.

IATF 16949 and ISO 14004 Certified



**CATTIN NORTH AMERICA**

[www.cattinina.com](http://www.cattinina.com)  
Pedetemptim sed incessanter®



**Sharpening Services**

- Hobs
- Milling Cutters
- Shaper Cutters
- Shaving Cutters
- Broaches



**Service Centers**

**Hoffman Estates, IL**

Phone: 847.649.1450

Fax: 847.649.0112

**East Tawas, MI**

Phone: 989.362.0414

Fax: 989.362.2720

**Querétaro, Mexico**

Phone: 52 442 217 34 45

Fax: 52 442 217 34 46



[sales@star-su.com](mailto:sales@star-su.com)  
[www.star-su.com](http://www.star-su.com)



HOB & SKIVE CUTTER SHARPENING BY PROFESSIONALS...  
FOR THE PROFESSIONAL GEAR MANUFACTURER.

WE UNDERSTAND YOUR INVESTMENT IN GEAR TOOLS IS SIGNIFICANT. WE GUARANTEE YOUR TOOLS ARE RETURNED ACHIEVING AND TYPICALLY UPGRADING SPECIFIED TOLERANCES. WE HAVE BEEN DOING THAT SINCE 1999.

- HOB SHARPENING
- SKIVING & SHAPER CUTTER SHARPENING
- BROACH SHARPENING
- STRIPPING, EDGE PREPARATION

**216-642-5900**



[www.IndexTechnologiesInc.com](http://www.IndexTechnologiesInc.com)

Fax: 216-642-8837 • Email: [gallen@gallenco.com](mailto:gallen@gallenco.com)  
5755 Canal Road, Valley View, OH 44125

# Manufacturing sMART

is your resource for the latest in great ideas from our advertisers. Check this section every issue for sMART Engineering ideas and technology.

For information about advertising, contact  
**Dave Friedman**  
at  
**(847) 437-6604**  
or  
[dave@geartechnology.com](mailto:dave@geartechnology.com).

## Watch *Gear TechnologyTV*

[www.geartechnology.com/tv/](http://www.geartechnology.com/tv/)



**Learn Something  
New Today!**

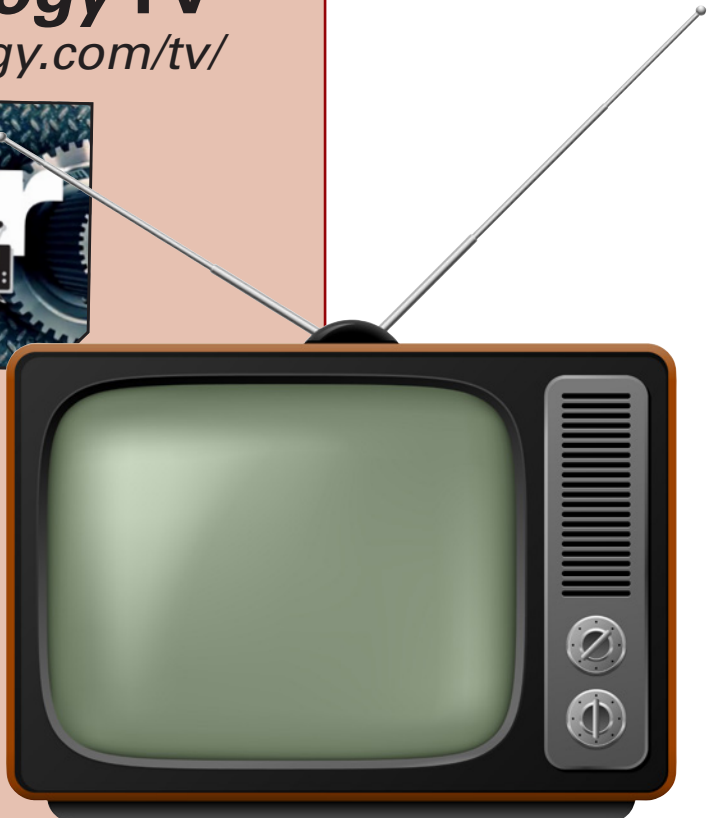

**Precision Mechanical Components & Assemblies**  
Standard Industrial Components | Made To Print Parts

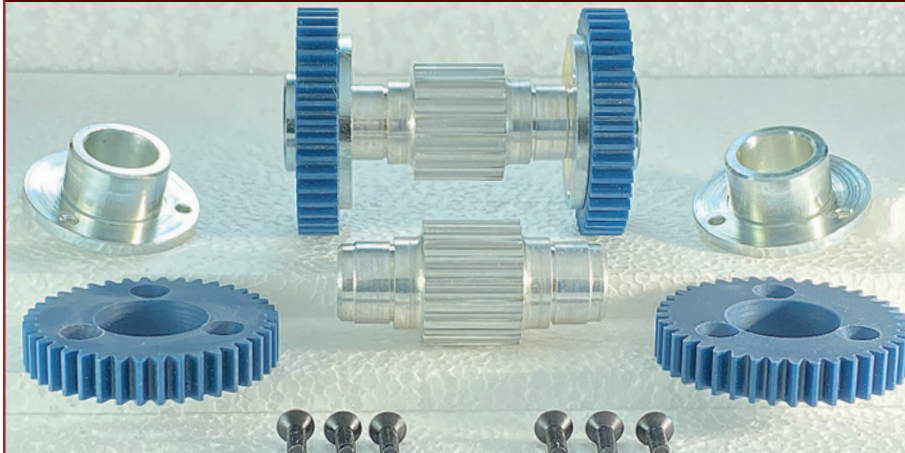

**Gears, Pulleys, Shafts, Bearings, Couplings, Fasteners, Custom Gear Boxes**  
Value Added Features and Services

- Engineering, Refurbishing & Design
- Custom Made To Print Parts
- Modified Standard Parts
- Assemblies & Sub-Assemblies
- Custom Mounts For Shafts
- Build Sub-Assemblies And Complete Assemblies
- Prototype Work

- ▶ Press bearings into pulleys
- ▶ Assemble bearings to shafts
- ▶ Set backlash on gears
- ▶ Assemble drive boxes
- ▶ Straightening
- ▶ Welding
- ▶ Kitting
- ▶ Plating / Custom Coating
- ▶ Heat treat

- ADD
- Grooves • Flats • Keyways • Pins
  - Threads • Staking • Pressing
  - Testing



**Nordex.com Sales@nordex.com Eng@nordex.com**  
**Phone: (800) 243-0986 or Call: (203) 775-4877**

**ORRIS DRIVE**  
**INCORPORATED**

**GEAR UP YOUR MOTION BUSINESS**



**Kashifuji**

**Worm Wheel**  
**Manufacturing Range:**  
OD max: 300mm  
Length max: 370mm  
Module max:7



**Drake GSTE240-360**

**Manufacturing Range:**  
Worm OD max: 300mm  
Worm Length max: 370mm

ESTABLISHED IN 1998 - OEM-ISO:9001:2015



- ▶ **Worm & Worm wheel customized**
- ▶ **Transmission Part**
- ▶ **Component and Assembly**
- ▶ **Made in Taiwan**

**E-MAIL: orris.drive@msa.hinet.net**  
**CONTACT: +886-4-25855657**

<http://b2b.worldtrade.org.tw/16697150>

**INSPECTION PROBES**

[www.united-tool.com](http://www.united-tool.com)

**CARBIDE TIP PROBES**



**CUSTOM MITUTOYO MICROMETER PROBES**



**SPECIALTY PROBES**



**HUNDREDS OF CARBIDE SIZES IN STOCK • QUICK LEAD TIMES • FAIR PRICING**



**UNITED TOOL SUPPLY**

851 Ohio Pike - Cincinnati, Ohio 45245 - 513-752-6000

Send all RFQs to [curtis@united-tool.com](mailto:curtis@united-tool.com)

# Documentation: A Challenge in Making Aerospace Gears

Joseph L. Hazelton, Contributing Editor

**For years, Reliance Gear Corp. has manufactured gears for the aerospace industry.** Located in Elmhurst, IL, Reliance has served as a Tier 2 or Tier 3 supplier. (Tier 1 suppliers work directly with the aerospace primes, the Boeings and Embraers of the world.) Like many gear shops, Reliance is certified under quality management standard ISO 9001. And its aerospace customers were satisfied with that certification. Until two years ago.

That was when Reliance learned it would have to become certified under another standard in order to keep making gears for its aerospace customers. The other standard: AS9100, the aerospace standard for quality management.

## Increased Documentation

As it turned out, though, the process for AS certification was more involved in time and money than the process for ISO certification, according to Harshad Gujarathi, the former managing director of Reliance. (Editor's note: Since talking to Gear Technology for this article, Gujarathi accepted a position at another company, vice president of operations at IMS Global Gear & Machining, Downers Grove, IL.)

At first, Reliance Gear's experience with AS9100 didn't seem much different from its experience with the ISO standard. Gujarathi recalls the first and second AS audits. For the first, Reliance prepared its documents and an AS auditor reviewed them. He did give Reliance some advice about expanding its documentation, but he appeared satisfied with its paperwork.

When he returned for a second audit, though, there was a problem. Reliance hadn't expanded its documentation to the extent the auditor had expected. The gear shop had to document considerably more in order to meet AS9100. To do that, Reliance sent its quality control manager to a training program on the standard. It also hired a consultant, a person with 25 years of experience as an AS auditor.

Through this process, Reliance learned how much detail it needed to provide in its documents under AS9100. Gujarathi gives a brief example: the training matrix for a machine operator. Under ISO 9001, it may be enough for the matrix to say that an operator was trained on this machine, this second machine, and this third machine. Under AS9100, the matrix has to say that the operator was trained on this machine, by this person, for this many hours, and has to say it for each machine.

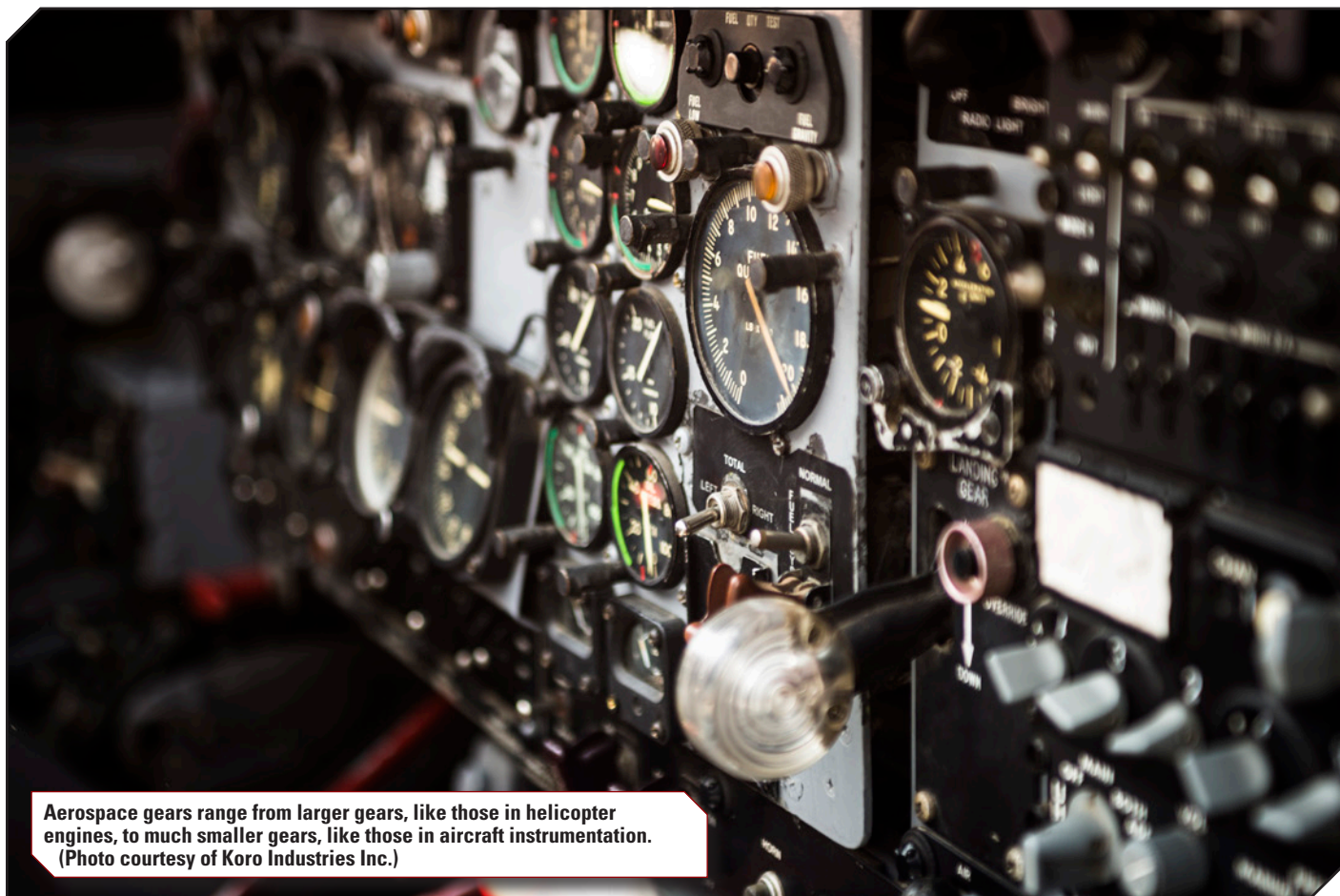

Aerospace gears range from larger gears, like those in helicopter engines, to much smaller gears, like those in aircraft instrumentation. (Photo courtesy of Koro Industries Inc.)



To make aerospace gears, some gear shops have to be certified not under ISO 9001, but under the aerospace standard for quality management, AS9100. (Photo courtesy of Reliance Gear Corp.)

Gujarathi describes AS9100 as a good standard and accepts that its requirements for aerospace work must be considerable: “It’s for a really good reason.” However, he adds that the necessary paperwork is also considerable.

The time and money spent to keep such detailed documents is one cost to a gear shop. Another is the AS audit itself. Gujarathi says an ISO audit can take a few days, an AS one can take a week. Also, during the audit, the quality control manager is preoccupied with the auditor every day. “He’s not working on anything else,” Gujarathi says.

He adds that the registration fees are different, saying that to register as ISO certified, it costs several thousand dollars; to register as AS certified, four to five times that.

“The cost differential and the requirements within the standard are so day and night that it becomes very difficult for a small company like ours to sustain that cost year after year,” Gujarathi says. “It’s not one time.”

However, AS9100 certification isn’t an across-the-board requirement of gear shops that serve the aerospace industry. For example, Koro Industries Inc. in Maple Grove, MN, also manufactures aerospace gears, specifically fine- and medium-pitch gears. Like Reliance, Koro is certified under ISO 9001, but Koro hasn’t been required by its aerospace customers to implement AS9100.

Despite that difference, both companies have to deal with the additional documents that come with working in the aerospace industry.

## Lists of Approved Suppliers

Once they cut teeth, gear shops often have to send their aerospace gears to subcontractors for additional processing, like heat treatment. However, some additional processes can be performed only by certain companies, companies specified by an aerospace customer.

These specified companies are on lists maintained by the customer. Each list tells a gear shop which companies are approved to supply a certain type of processing. Like the shop itself, these suppliers get on the customer’s lists by doing the work to meet the customer’s own certification requirements, which include audits conducted by the customer.

These approved suppliers can be a reassurance. A gear shop can relax a bit about sending a customer’s aerospace gears to these suppliers. “They’re approved for this customer,” Gujarathi says. “They know exactly their requirements.”

However, many companies may be unwilling to do the extra work to become certified, so an aerospace customer’s lists may be limited. “We have to go to very few, a pool of very few subcontractors,” Gujarathi says.

Steve Korosec echoes that comment. The president of Koro Industries, Korosec says the manufacture of aerospace gears: “It’s a small industry.”

Gujarathi adds that this situation wasn’t always the case. In the past, Reliance could pick any subcontractor to do additional work on its aerospace gears, so long as that company could do the processing to the gears’ specifications.

Moreover, Gujarathi notes: “The requirements around special processes—plating, coating, heat treatment—those are becoming more and more stringent.”

More stringent requirements can mean looking at more documents.

## Pre-Production Research

As Gujarathi explains, a gear shop needs an understanding of each outsourced process in order to work with the subcontractors that are performing the processes. “It puts a big intellectual drain on us,” he says. “We are responsible for those products, even if the subcontractors are doing that [processing] for us.”

The amount of paperwork is described by Korosec. For his example, he uses purchase orders from aerospace customers.

“You can have a purchase order now that is the thickness of a small-town phonebook: a quarter-inch thick,” Korosec says. Once it has the order, a shop has to review it to figure out which clauses apply to in-house production and which apply to each of the subcontractors. Also, a clause may or may not apply to the part the shop is making.

Moreover, figuring out the clauses may not be the end of the work. For example, a clause about plating may not include the exact specification needed to meet the customer’s requirement. The clause may only refer in general to the specification. As the contractor, the gear shop has to go onto the website of its aerospace customer and get the latest version of the actual specification.

With the specification in hand, a gear shop looks for subcontractors already certified by the aerospace customer. It’s a

help then that a shop can refer to the customer's lists of already approved suppliers.

"So, you contact them when you get an order for such and such a part," Korosec says, "and you talk to them about the plating requirements, just to use plating as an example." If the talk goes well, the subcontractor will say it often runs that process for the aerospace customer.

However, checking with a subcontractor about its documentation can become more involved. Specifications may be superseded by other specifications. So, when talking with a subcontractor: "You always have to check to be sure that they have the most up-to-date spec for everything," Korosec says.

And an upshot of this effort? "You spend as much time on pre-production research, sometimes, as it takes to make the parts," Korosec says. "It's just incredibly different than it used to be."

"Years ago, 40 years ago, you'd get a purchase order to make parts for a flight instrument, and you got a one- or two-page purchase order, plus a drawing," Korosec says. "That is not the way it is anymore. And a lot of times back then, you just sent them a material cert—if that—and no cert was required for plating processes or anything like that."

Korosec knows about documentation from 40 years ago because he started working at Koro Industries, his parents' gear shop, in the mid-1960s, when he was still in grade school. "I saw all these changes happen," he says.

So, while documentation has increased, a gear shop may save time with an aerospace customer's lists of approved suppliers. When a list is short, though, it may become a problem.

### Short Lists: Problematic Sometimes

Now, a short list can be a help when your gear shop is one of the few on the list. Clarke Gear Co. knows that feeling. Lee Mason, Clarke's chief operating officer, says there is a trend among aerospace companies to use fewer gear shops, but she adds: "Fortunately, we're one of two for our main customer."

In that case, Clarke Gear has a 50-50 chance of being contacted by the customer, a large aerospace company, when it needs more gears.

However, a short list can be a problem when your shop has to use that list. Clarke Gear knows about having to use a short list.

Recently, the shop was making gear shafts for an aerospace customer. The shafts had to be silver-plated. No problem. The customer had a list of approved plating companies, just two companies, but Clarke Gear had worked with one of them for years.

Then came a surprise: The customer changed the status of that plating company. "They suddenly disapproved them," Mason says. Clarke Gear had no choice. It had to use the one remaining company. Clarke had to ship the shafts from its location, North Hollywood, CA, to the plating company's location—across the country.

"We had to send these extremely high-risk parts to the East Coast," Mason says. "When I got the shipment bill, that took at least half of the revenue that was going to come from those parts." She says that similar surprises occur more often than



**Koro Industries made gears that were used in the mission to fix the out-of-focus lens in the Hubble Space Telescope, which hovers at the boundary of Earth and space. (Photo courtesy of NASA and the Space Telescope Science Institute)**

they used to and adds that a few of those surprises do drive up the cost for Clarke Gear—but not the price to the customer.

Besides maybe having to use a "list" of one approved supplier, a gear shop may sometimes have to go off-list.

### Going Off-List

Naturally, gear shops try not to go off-list. However, there are times when it's unavoidable. In those cases, a shop calls the customer to talk about going off-list. "If they have already got approved suppliers," Korosec says, "they're going to want to know: 'Why do you want to change it?' And so, you try and work with the approved list whenever possible."

And usually it is possible. "There are usually enough vendors that you can find someone that can handle your size part or tolerated part," Korosec says.

And that's another possible problem. For example, a list may have five approved suppliers, but some of them may not be able to process your gear shop's parts.

Korosec uses plating companies again as an example. With them, tank size isn't likely to be a problem when processing aerospace gears, especially small ones. However, some plating companies may not specialize in small parts. So, some effort may be needed to find the right fit in terms of capacity and handling.

Korosec adds that Koro Industries goes to a non-approved supplier: "Very seldom." He also adds that he can't recall going off-list in the last two or three years.

Some processes, though, don't need certification. An aerospace customer may not require it, so a gear shop won't need to look at a list of approved suppliers for this or that process.

Mason mentions several non-certified processes: grinding, honing, drilling, gundrilling. Other processes do need certification, like heat treating and plating. "Those can only be performed by approved suppliers," Mason says.

Naturally, additional documentation comes with a cost. But, it also comes with a challenge.



## Dealing with the Documents

The cost is the time and people needed to create the documents and store them so they can be retrieved on demand. Korosec says the challenge is to handle all of this paperwork in ways so it's not crippling to the office.

And the documents have to be organized for on-demand retrieval in case of audits by aerospace customers. Korosec says that a couple of times a year, an aerospace customer will request the cert for this or that purchase order. So, the shop will go into its electronic files and send the documents to the customer, including the certifications for the gear material and for any special processes used to make the gears. Requests may be used to gauge the ability to meet audit requirements.

Finally, after the challenge of dealing with many documents, a gear shop has the work itself of making the gears on its factory floor. That work can be a challenge too, with its own trends. However, the work is the shop's core competency.

And manufacturing trends can be long established. One long-time trend is tighter tolerances, according to Jerry



The in-house processing to make an aerospace gear may be a small percentage, with other processes, like plating, done by subcontractors. (Photo courtesy of Air Gear Industries International Inc.)

Bennett. He's the chief inspector/quality manager for Air Gear Industries International Inc., Phoenix, AZ. Air Gear serves the aerospace industry by refurbishing gears for aircraft, such as helicopters and turboprop planes.

Bennet himself has spent much of his career dealing with the trend of tighter tolerances among aerospace companies.

"It seems that all the companies are tightening up on involute lead, composite error, total runout a lot from back in the day. A lot of people have taken the AGMA 12, the AGMA 13 gears and even tightened them up more," Bennett says.

"All they're doing is just tightening them up." ⚙️

### For More Information:

Air Gear Industries International Inc.  
Phone: (602) 275-7996  
[www.airgearindustries.com](http://www.airgearindustries.com)

Clarke Gear Co.  
Phone: (818) 768-0690  
[www.clarkegear.com](http://www.clarkegear.com)

Koro Industries Inc.  
Phone: (763) 425-5247  
[www.koroind.com](http://www.koroind.com)

Reliance Gear Corp.  
Phone: (630) 543-6640  
[www.reliancegear.com](http://www.reliancegear.com)

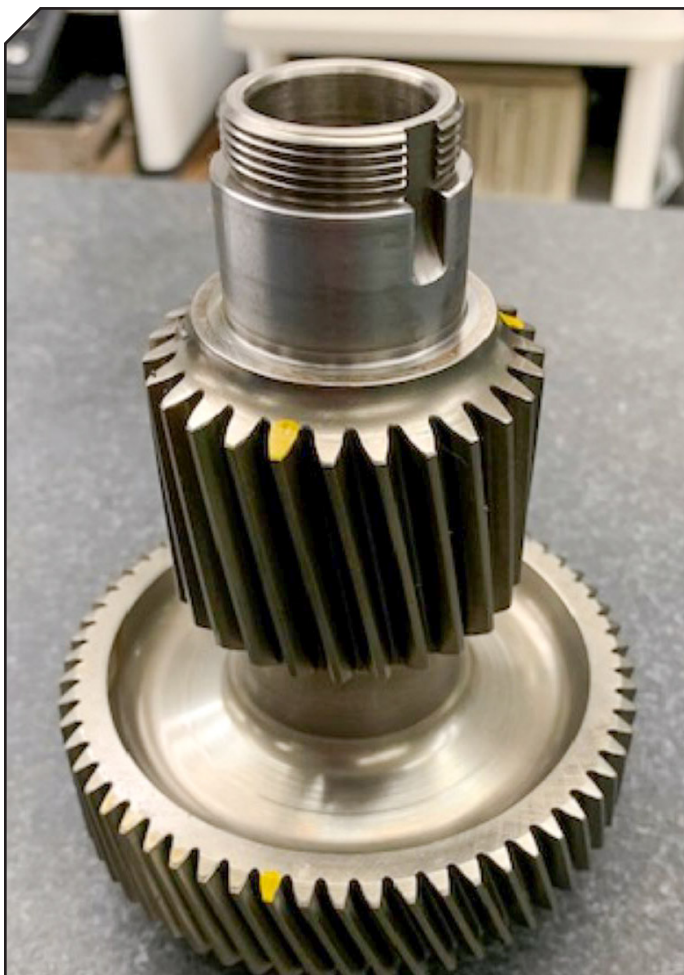

The documentation to do aerospace work can be extensive, with gear shops having to meet standards to work for U.S. customers and other standards for European customers. (Photo courtesy of Air Gear Industries International Inc.)



# Analyzing Bevel Gear Damage Prediction Over Operating Life

## FVA software offers simulation and calculation of transmission systems

The *FVA-Workbench* is a manufacturer-neutral tool for the simulation and calculation of transmission systems. As product development cycles become shorter, powerful modeling approaches and calculation algorithms become increasingly important. The predominantly analytical approaches in the *FVA-Workbench* deliver fast and reliable solutions to all important issues related to drive technology. For bodies that cannot be accurately described analytically, the results are supplemented by suitable numerical methods.

The calculations are developed, analyzed, and validated in research projects by Forschungsvereinigung Antriebstechnik e.V. (FVA, the Research Association for Drive Technology). Through member contributions and public funding, the FVA can organize 17 million euros annually in research projects at leading German universities, chairs, and research institutions. The *FVA-Workbench* serves as a knowledge platform, making the results of FVA research projects available and accessible to all engineers. It is no longer necessary to read through and study countless pages of scientific documentation, making the development of innovative gearboxes considerably more efficient and user friendly.

### Bevel and Hypoid Gear Calculation Methods in the FVA-Workbench

Marine, rail, automotive, aviation: bevel and hypoid gears are used in a wide variety of industrial applications. One thing these applications have in common is that the power flow changes directions. The design requirements, and therefore the calculation methods, are as diverse as the possible applications. These can range from standard calculations with only a few input variables to calculation of the local load carrying capacity with consideration of the gear environment and the expected load spectrum.

For calculations according standards

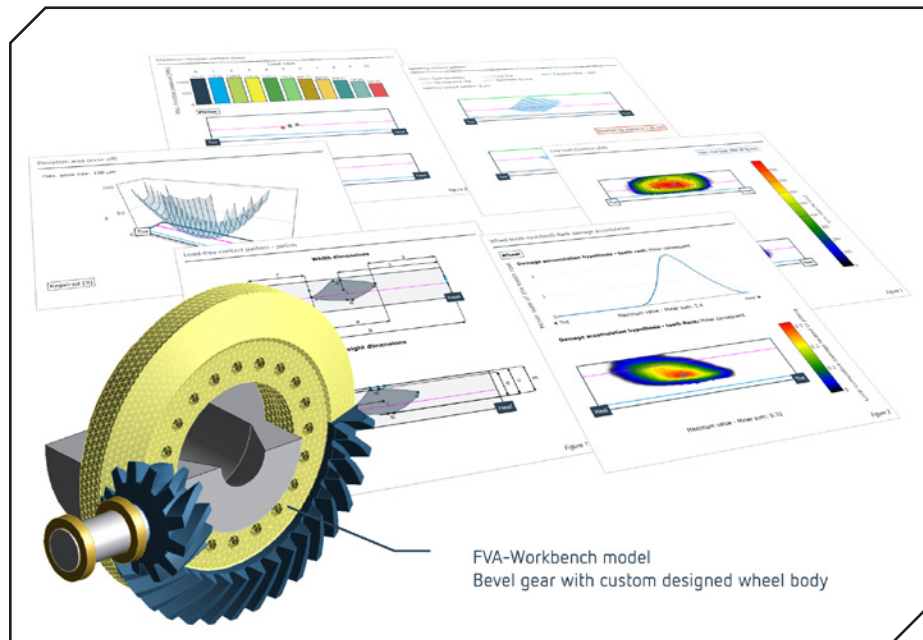

FVA Workbench

and classification societies, the only required input variables are the macro-geometry of the bevel gear; the operating conditions, consisting of the speed, torque, and operating mode; as well as the material and lubricant specifications. The foundation of these load capacity analyses is the suitable conversion of the bevel gear geometry into a substitute cylindrical gear that sufficiently approximates the meshing conditions of the bevel gear to be calculated. As a result, safety factors are provided that allow statements to be made regarding the load capacity of the gear under the specified load.

Current and historic versions of all relevant load carrying capacity standards are available in the *FVA-Workbench*. Additionally, methods developed by the FVA that have a normative character can also be used (e.g. FVA Research Project 411, "Load Capacity of Hypoid Gears," Technical University of Munich Institute of Machine Elements, Prof. Dr. Karsten Stahl). Furthermore, marine classification society rules are also included for

simple use. However, these standard calculation methods can only approximately describe the complex meshing conditions of bevel gears. The micro-geometry, which includes modifications to the effective flank among other things, is insufficiently considered in the calculation or not at all. Likewise, relative position deviations also cannot be directly considered in these calculations. Due to the sensitivity of bevel gears to displacement, the shape of the contact pattern, which results directly from the micro-geometry, plays a decisive role. For this reason, the local bevel gear calculation methods in the *FVA-Workbench* provide crucial support.

The required nominal geometry of the gear is determined via a manufacturing simulation. All necessary information such as the basic geometry; machine setting data; tool data; and kinematics, including additional movements, are taken from manufacturer-specific interfaces (e.g. *KIMoS* neutral data) and converted to the universal bevel gear cutting machine. The tooth flanks, including the

tooth root area, are simulated point-by-point and mathematically mapped via fitting surfaces.

As all manufacturing information is incorporated into the simulated gearing points, the nominal geometry, including the ratio of curvature, is mapped from the modeled tooth flanks. In the tooth contact simulation, the tooth flanks are brought into mesh and rolled.

When considering the bevel gear stage in the overall system, the operating conditions, installation dimensions, and load-dependent displacements as well as supplementary wheel body geometry descriptions are included in the complex tooth contact simulation, and thus all subsequent calculation steps, in addition to the determined nominal geometry.

**Load-free tooth contact simulation:** The results of the load-free tooth

contact simulation - from the ease-off and contact pattern calculation and the optional calculation of the circumferential backlash and ductility of the bevel pinion - form the basis for all subsequent calculations, and include important statements on the effectiveness of the micro-geometry design (ease-off) on the displacement behavior and meshing interference (size and position of the contact pattern).

**Local stress calculation:** Building on these results, the stress calculation is performed based on the influence numbers method, a numerical calculation method with which the load and stress distributions at discrete points can be efficiently calculated. By default, the stiffness of the wheel body is approximated by an elastic half-space. With the *FVA-Workbench*, a wheel body and its clamping can optionally be specified as a complex

wheel body geometry. Wheel bodies can easily be loaded as CAD geometry and then positioned and meshed in the *FVA-Workbench*.

The influence numbers are then calculated, taking the specified wheel body into account according to FVA Research Project 223 XVI ("BECAL Wheel Bodies," Technical University of Dresden Institute of Machine Elements and Machine Design, Prof. Dr. Berthold Schlecht). As a result, the user receives the locally solved load and pressure distribution as well as the local sliding speeds. A resulting efficiency is determined for the considered stage and from the calculated geometry and the contact description of the mesh stiffness curve over the mesh positions and the transmission error. The transmission errors are a measurement for the running behavior of the gear at an operating point.

In the assembly process, the load-free contact pattern is the decisive parameter with which the bevel gear stage is configured, and the bevel gears are aligned to each other. In order to be able to compare the contact pattern with the calculation, a guideline for measuring and characterizing contact patterns was developed in FVA Research Project 223 XV ("Contact Pattern Measurement," Technical University of Dresden Institute of Machine Elements and Machine Design, Prof. Dr. Berthold Schlecht).

At the same time, the bevel gear calculation was also extended to output the relative position of the contact patterns. The tests performed in the research project show that the load-free and loaded contact patterns in the *FVA-Workbench* correlate very well with the actual contact patterns. This provides the user a powerful tool for analyzing the contact patterns of bevel gears. An example of an *FVA-Workbench* report is shown in Figure 1.

**Local load carrying capacity calculation:** The material stresses can be derived from the contact pressure and converted to a pitting safety factor. The

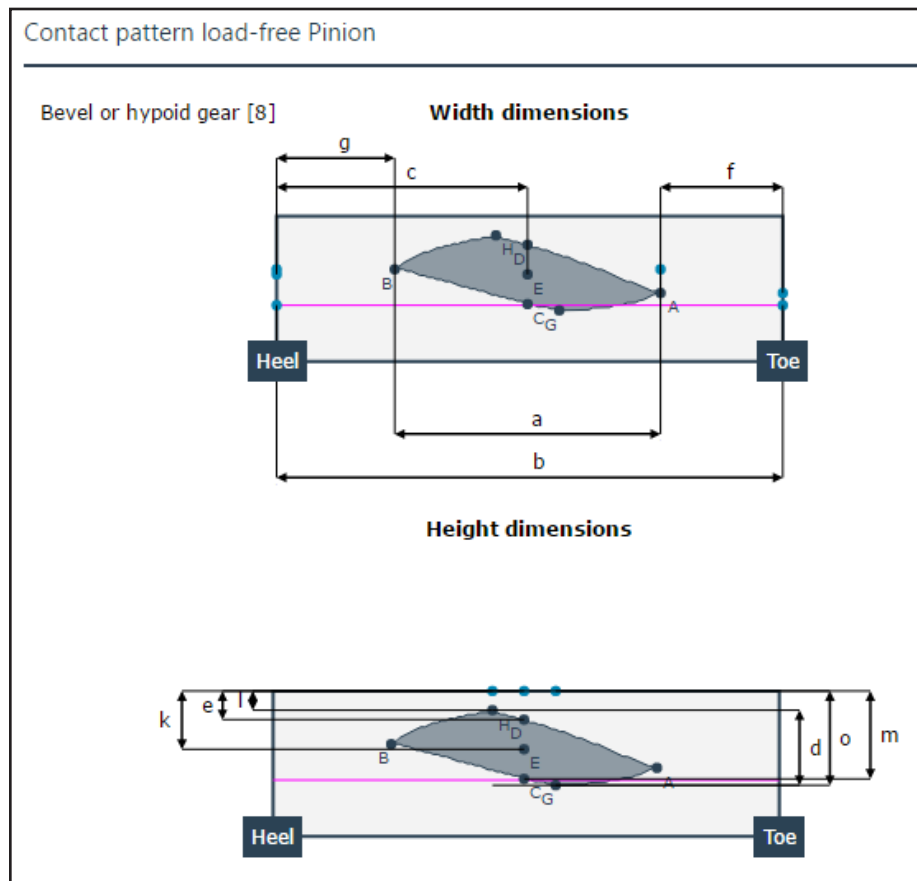

Figure 1 Contact pattern measurement.

safeties are carried out in the same way as the standardized calculation methods, as the same strength values are used. The local material fatigue load capacities were developed and validated in FVA research project 411. The local safety against micropitting was examined in FVA Research Project 516 (“Micropitting of Hypoid Gears,” Technical University of Munich Institute of Machine Elements, Prof. Dr. Karsten Stahl). In contrast to damage from material fatigue, the safeties against pitting according to FVA 411 (see Figure 2) and micropitting according to FVA 516 on the tooth flank are calculated, as are the safety against root fracture according to ISO 10300 and the safety against scuffing due to excessive contact temperature according to FVA Research Project 519 (“Scuffing of Hypoid Gears,” Technical University of Munich Institute of Machine Elements, Prof. Dr. Karsten Stahl).

The local load carrying capacity in connection with the overall system calculation is of interest. The system calculation in the *FVA-Workbench* considers the stiffness of all components in the gearbox and uses them to calculate the occurring deformations. The relative displacements of the bevel gear stage are calculated from the shaft bending line and automatically considered. In this way, bevel gear stages can very easily be calculated and evaluated, taking all relevant influences into account.

**Local damage accumulation in the load spectrum:** With a local damage accumulation calculation the real load conditions, which change during the operating period, can be considered in the tooth contact simulation and subsequent local load carrying capacity calculation. In this way, the user receives the first indication of the location of the greatest damage and thus the area at which pitting damage and root damage are most likely to occur, as well as an estimation of the amount of fatigue.

In addition to the local methods described above, embedded in the overall system, a bevel gear can also be

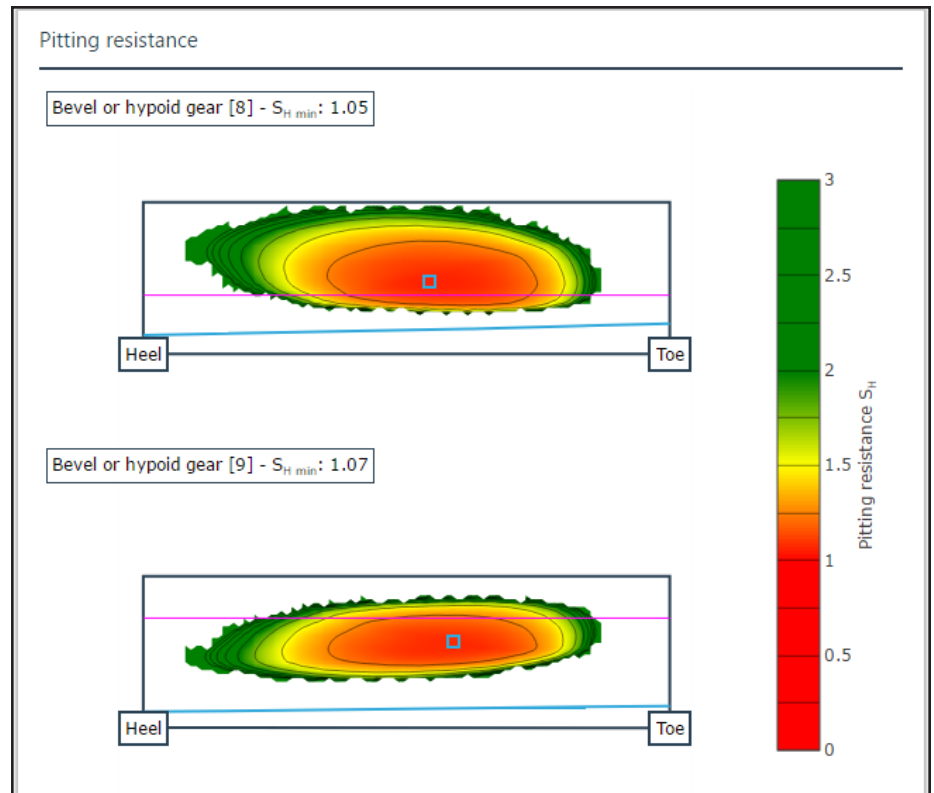

Figure 2 Local pitting resistance.

considered as a single stage. Additional calculation options are available as analysis tools, such as variational calculations and damage simulation. For the single stage calculation, it should be noted that the relative locations as well as the operating conditions must be specified by the user, independent of the overall system.

**Variational calculations:** A specific characteristic of bevel gears is their sensitivity to displacement, i.e. changes to the size and position of the contact pattern due to relative position changes. Automatic variation of the torque and speed combined with load-dependent relative position deviations provides a quick overview of the changes to the local stresses and safety factors. The individual results are compiled in graphical representations to facilitate their evaluation.

**Local damage simulation:** In addition to the usual local load carrying capacity calculation, the local damage to the tooth flank can also be simulated according to the implementation of FVA Research Project 223 XII (“Damage Progress,” Technical University of Dresden Institute of Machine Elements and Machine Design, Prof. Dr. Berthold

Schlecht). The simulation of the formation of pitting and micropitting is based on the determination of the load carrying capacity, the calculated resulting cumulative damage, and determination of the resulting flank deformation. As the simulation includes damage from constant changes to the flank form, the interactions between micropitting and pitting damage as well as the influence of the damage on the flank load carrying capacity can be shown. As the calculation of the local damage simulation corresponds to the current state of research, the validation process is not yet complete. However, the current status shows promising results. ⚙️

**For more information:**

FVA GmbH  
Phone: +49 69 6603 1663  
[www.fva-service.de](http://www.fva-service.de)



**INTERNATIONAL MANUFACTURING TECHNOLOGY SHOW**  
September 14 - 19, 2020 | McCormick Place | Chicago

***Advanced technologies  
that break the mold.***

**[IMTS.com/advanced](https://www.imts.com/advanced)**



*Technology demonstrated  
courtesy of 3D Systems*

# Shaft Positioning Tolerances for Bevel Gears

Email your question — along with your name, job title and company name (if you wish to remain anonymous, no problem) to: [jmcguinn@geartechnology.com](mailto:jmcguinn@geartechnology.com), or submit your question by visiting [geartechnology.com](http://geartechnology.com).

## QUESTION

Could you help me with a doubt? We know that for cylindrical gears we have the standard DIN 3964 for defining deviations of shaft center distance and shaft position tolerances of casings. And for bevel gears? Is there some specific standard for defining deviations of center distance and shaft position tolerances of casings (orthogonal shafts), as DIN 3964 do? Thank you for your help.

### Response provided by Dr. Hermann J. Stadtfeld:

For cylindrical gears, tolerances for deviation of shaft center distances and shaft position of casings are presented in DIN 3964 (Ref. 1). The DIN standard covers center distance and shaft inclination tolerances for involute cylindrical gears. The standard bases on the fact that spur and helical gears with an involute profile and a straight lead function behave very similar, across a wide range of modules, helix angles and face widths. The term “center distance insensitivity” of involute gears only refers to the transmission accuracy, which is not influenced within a certain range of center distance increase. However, if the center distance reduces, an interference condition will arise from a certain point on. An increase of center distance as shown (Fig. 1) has no impact on the transmission error between the driving and the driven member, yet, it will create an increased backlash which can cause rattle noise in light load conditions (Ref. 2).

The question, if a similar standard or guideline also exists for bevel gears must be answered with “no”. The major reason for this is the wide range of different parameters which influence the sensitivity of a bevel gearset. The following parameters have a direct influence on the sensitivity and therefore on the permissible deviations of the bevel gear shafts:

- Spiral angle
- Lead function (straight, circular, epicycloidal, involute)
- Shaft arrangement (90°, angular, offset)
- Cutter diameter
- Crowning (length, profile, twist, higher order)

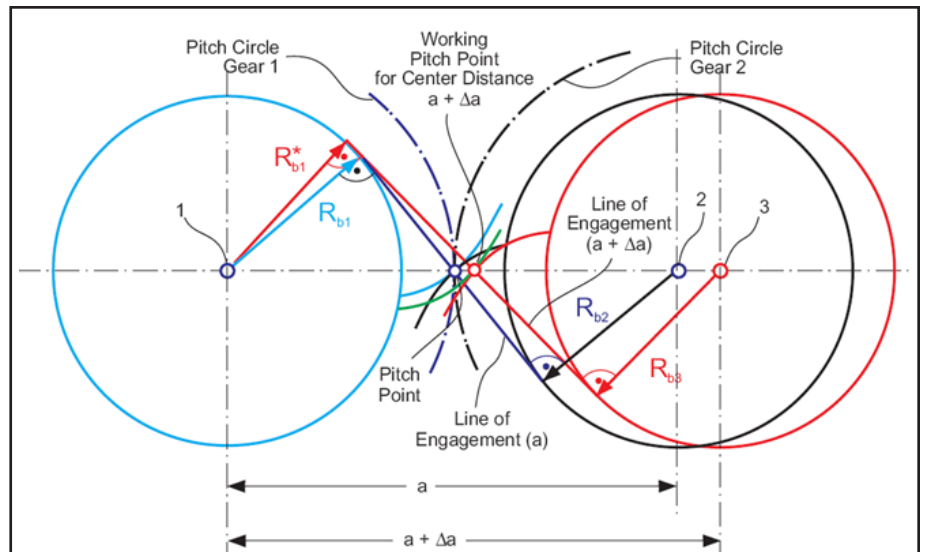

Figure 1 Center distance insensitivity of involute cylindrical gears.

The Gleason Works developed a guideline with tolerances for allowable shaft positioning deviations of average bevel gearsets of the following categories:

- Miter straight bevel gears
- Straight bevel gears
- Miter spiral bevel gears
- Spiral bevel gears
- Hypoid gears
- Super reduction hypoids

The new Gleason guidelines are based on the Gleason backlash Table and on maximal shaft displacement recommendations (Ref. 3). An average bevel gearset is the gearset which is generated by the bevel gear design software when using default input parameters. It has to be acknowledged that particular applications of bevel and hypoid gears can be significantly more or less sensitive and would require their own custom set of tolerances.

Angular bevel gears have shaft angle not equal to 90°. As the shaft angle gets closer to zero the bevel gearset behaves more like a cylindrical gearset. In this case, the tolerances for cylindrical gears apply. As the shaft angle gets closer to 180°, the bevel gearset behaves more like a clutch and the tolerances of clutches can be applied.

### Bevel and Hypoid Gear Sensitivity Evaluation

Bevel and hypoid gearsets have a very individual displacement behavior, which is why the national and international standards were not able to establish a set of tolerances which are generally applicable. The bevel and hypoid gear calculation programs use the so-called “V-H-Check,” — introduced by Gleason in 1965 — in order to express the sensitivity of a bevel gearset. The shaft

displacement in the directions E (offset), P (pinion axial), G (gear axial) and ALPHA (shaft angle) are sufficient for capturing the axis deflections in three linear and three angular directions (Fig. 2). A set of deflections  $f_{\alpha}$ ,  $f_{\beta_{gear}}$  and  $f_{\beta_{pinion}}$  can be converted into an equivalent set of deflections  $E^*$ ,  $P^*$ ,  $G^*$  and  $ALPHA^*$  as demonstrated (Fig. 3). For this reason the tolerances  $f_{\beta_{gear}}$  and  $f_{\beta_{pinion}}$  do not exist in reality.

The Gleason V-H-Check moves the contact pattern from a center position to a position between center and heel, and then to a position between center and toe (Fig. 4).

The difference between the axes positions in heel and toe position are the total V-H-displacement numbers. Bevel gear transmission housing designers use these total V-H-numbers in order to optimize the stiffness and the deflection characteristic of the transmission housing. As soon as a housing concept exists, finite element calculations of the gearbox deflection are used to calculate predicted shaft positioning deviations, which are then used as input to the contact analysis program in order to verify which influence the calculated deflections have on the position of the tooth contact. Depending on the resulting tooth contact, a tooth surface optimization has to be conducted in order to adjust the deflection characteristic to the transmission housing. This loop between transmission housing design and bevel gear optimization has to be repeated multiple times to assure a displacement characteristic of the bevel gearset which offsets the housing deflections.

The attempt to provide shaft deflection tolerances using the V-H-Check deflection numbers showed severe shortcomings, as the V-H-Check fails to identify the changing backlash. In cases of load-affected deflections, the increase of backlash is acceptable and does not present any obstacles. An exception is the case of coast-side operation, where the backlash reduces and severe flank surface damages can occur.

However, the general tolerances for the positioning of bevel and hypoid gear shafts has to be based on both — the contact movement as well as the allowable reduction or increase of the backlash as a result of the shaft miss-positioning.

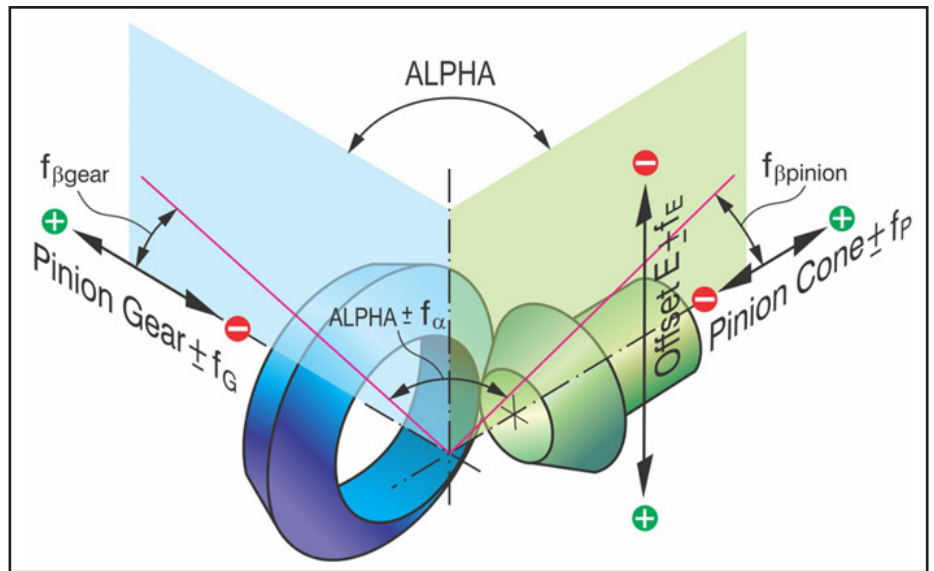

Figure 2 Bevel gear axis definitions and nomenclature.

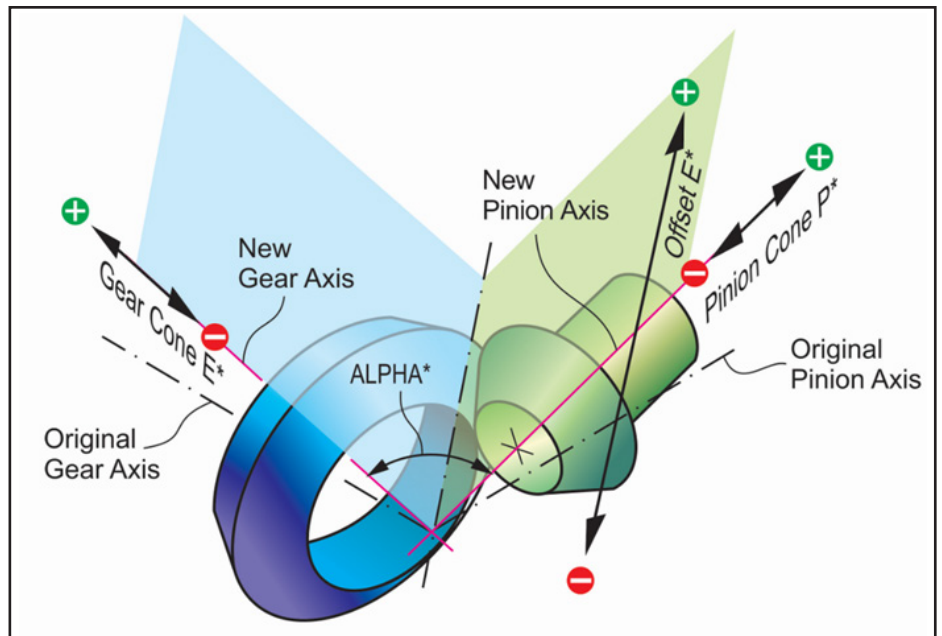

Figure 3 Transformation of 6 deflections into 4 deflections.

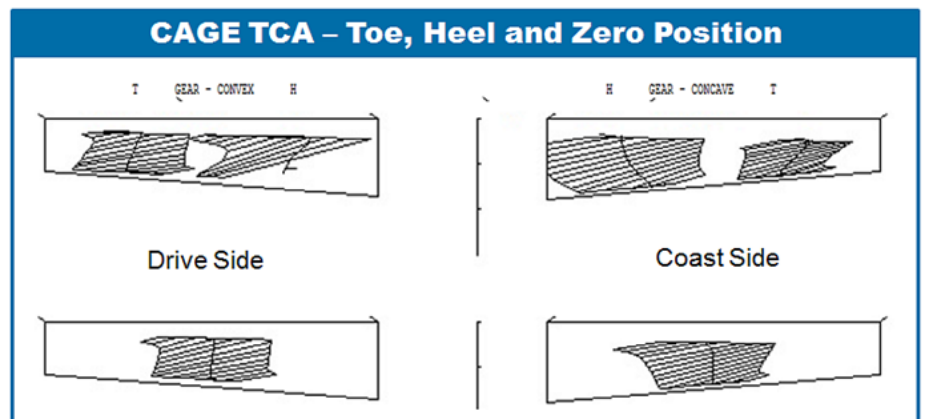

Figure 4 Gleason V-H-Check.

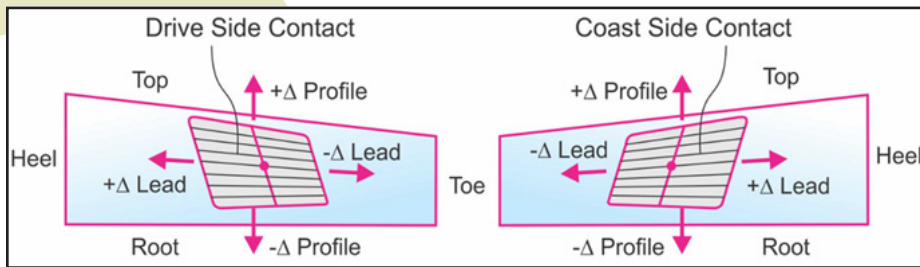

Figure 5 Contact movement in profile and lead direction.

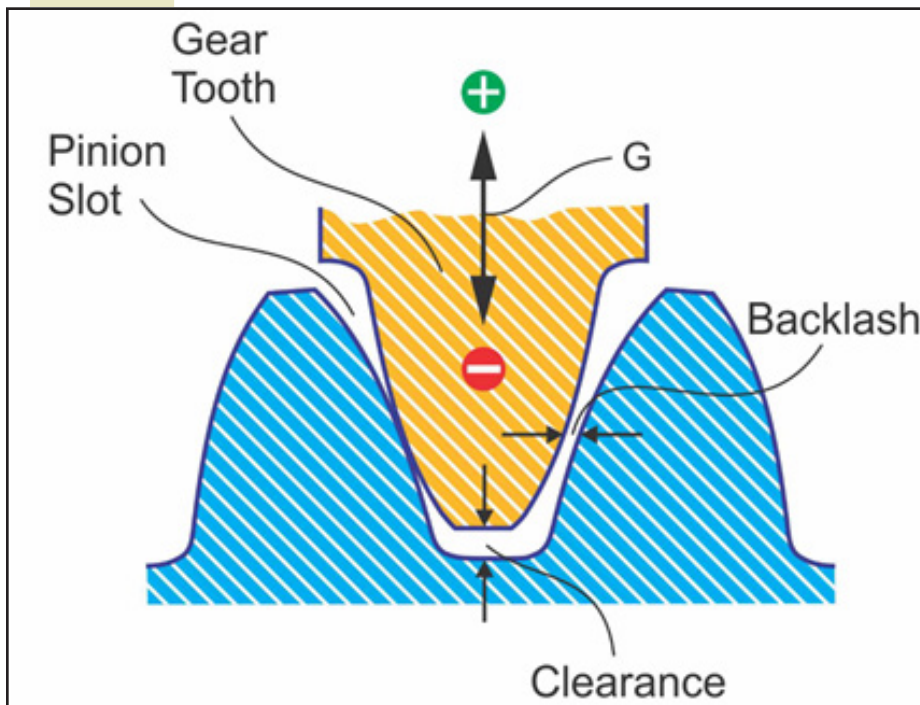

Figure 6 Change of backlash due to gear cone change G.

Module [mm]	Diametral Pitch [1/inch]	Min. Backlash [mm]	Max. Backlash [mm]
0.21	120.00	0.008	0.018
0.31	81.00	0.013	0.025
0.62	41.00	0.025	0.051
1.27	20.00	0.051	0.102
2.54	10.00	0.076	0.127
3.18	8.00	0.102	0.152
4.23	6.00	0.127	0.178
5.00	5.00	0.152	0.203
6.35	4.00	0.178	0.229
7.26	3.50	0.203	0.279
8.47	3.00	0.254	0.330
10.00	2.50	0.305	0.406
12.70	2.00	0.356	0.457
14.51	1.75	0.406	0.559
16.93	1.50	0.457	0.669
20.32	1.25	0.508	0.762

## Recommended Backlash and Tolerances

The Gleason backlash recommendation and its tolerance are not linked to a gear quality class. In Table 1, the backlash ranges have originally been defined for applications with medium speed and oil sump lubrication. Depending on the kind of transmission and the field of application, a manufacturer can deviate from the recommended values, utilizing data from their own testing. Backlash ranges are given from module 0.21 mm (DP 120/inch) up to module 20.32 mm (DP 1.25/inch). The Table is a conversion from the initial Imperial units, which explains the unusual decimal fraction of the SI units. For bevel and hypoid gears, the backlash is the most important basis of all shaft position tolerances. Common sense tells the gear engineer that each dimensional deviation, which impacts the shaft positioning within the backlash tolerances, is permissible.

## Basis of Shaft Deviation Tolerances

In many cases of industrial gearbox design with bevel gears, the Gleason guideline with tolerances for the bevel gear shaft positioning tolerance can be very helpful. The tolerances which are compiled for average gearsets might not be the optimal numbers for the specific gearset a manufacturer is developing. Nevertheless, the Gleason tolerance guideline may be very useful at a stage when only few details of a new transmission are finalized.

In order to have a solid foundation for the shaft positioning tolerances, the impact onto the backlash as well as the contact pattern movement have been considered during the development of the tolerance tables. The contact movement definition is shown (Fig. 5). Contact movements in lead direction had been limited to 1.0 mm and profile movements were limited to 0.3 mm for medium-size bevel gearsets with module 4 mm.

A simplified graphic demonstrates (Fig. 6) the influence to the backlash if the gear cone distance G is changed. If the theoretical backlash is defined precisely in the middle of the tolerance given in Table 1, then any of the shaft positioning tolerances, or the worst-case



combination of those tolerances, shall not change the backlash to a value outside of the given tolerances. The following shaft positioning tolerance tables are based on the maximally permissible contact movement and the maximally allowed backlash change. Both criteria are evaluated for each shaft deviation tolerance. The tolerance value was defined at the point when the permissible limit of one criterion was reached.

If the backlash is set in the transmission housing during assembly, e.g. — by a gear cone adjustment — then it appears always possible to obtain correct backlash independent from the shaft positioning tolerances. However, such a backlash adjustment would in case of shaft deviations, which exceed the recommended values in the following tables, result in unacceptably large tooth contact position errors and distortions. Therefore, the following tables are also valid in case of individual backlash setting in the transmission assembly.

### Shaft Deviation Tolerances for Bevel and Hypoid Gears

The following tables for the different bevel gear types show, sorted by module, the E, P, G and ALPHA tolerance values. The last row lists the expected but permissible contact movement in case of maximal shaft positioning errors, provided these are within the mentioned tolerance limits.

Table 2 was compiled for miter straight bevel gears. The offset tolerance allows equal positive and negative deviations, because the backlash increases in both directions. Miter bevel gears are bevel gears with a ratio of one. A major difference to bevel gearsets with ratios above 2.5 is setting the backlash; it is typical for ratios above 2.5 that a gear cone adjustment barely influences the contact pattern position, which is why the backlash adjustment in the assembly is done by shifting the gear axially (G) until the correct backlash is obtained. In case of miter gears, both the pinion axial position P and the gear axial position G influence the backlash equally. However, shifting only one of both will also change the contact pattern position. In case of small changes within the tolerances shown in Table 2 (equal for pinion cone P and gear cone G) the contact movements are

Module	2mm	4mm	6mm	12mm
E +/-	0.023mm	0.047mm	0.070mm	0.140mm
P +/-	0.011mm	0.023mm	0.034mm	0.068mm
G +/-	0.011mm	0.023mm	0.034mm	0.068mm
ALPHA +/-	0.035°/0.020°	0.035°/0.020°	0.035°/0.020°	0.035°/0.020°
Contact Displacement +/-	0.5mm	1.0mm	1.5mm	3.0mm

Module	2mm	4mm	6mm	12mm
E +/-	0.023mm	0.047mm	0.070mm	0.140mm
P + (no minus)	0.027mm	0.054mm	0.080mm	0.160mm
G +/-	0.011mm	0.023mm	0.034mm	0.068mm
ALPHA +/-	0.035°/0.020°	0.035°/0.020°	0.035°/0.020°	0.035°/0.020°
Contact Displacement +/-	0.5mm	1.0mm	1.5mm	3.0mm

Module	2mm	4mm	6mm	12mm
E +/-	0.025mm	0.050mm	0.075mm	0.150mm
P +/-	0.015mm	0.030mm	0.045mm	0.090mm
G +/-	0.015mm	0.030mm	0.045mm	0.090mm
ALPHA +/-	0.035°/0.020°	0.035°/0.020°	0.035°/0.020°	0.035°/0.020°
Contact Displacement +/-	0.4mm	0.8mm	1.2mm	2.4mm

Module	2mm	4mm	6mm	12mm
E +/-	0.025mm	0.050mm	0.075mm	0.150mm
P + (no minus)	0.020mm	0.040mm	0.060mm	0.120mm
G +/-	0.011mm	0.022mm	0.033mm	0.066mm
ALPHA +/-	0.035°/0.020°	0.035°/0.020°	0.035°/0.020°	0.035°/0.020°
Contact Displacement +/-	0.5mm	1.0mm	1.5mm	3.0mm

within permissible limits.

The tolerances in Table 3 were compiled for straight bevel gears. The offset tolerance allows equal positive and negative deviations. The pinion cone tolerance prohibits negative values due to the risk of metal-to-metal tooth jamming. The positive P tolerance is rather large, because of the small effect to the backlash. Backlash is commonly adjusted by changing the gear cone during the bevel gear assembly. A gear cone deviation tolerance which will change the backlash by +/-50% of the backlash range is shown in the Table (range equal maximum backlash — minimum backlash). The shaft angle allows a negative tolerance which will reduce the backlash by 40% of the backlash range and a positive tolerance which increases the backlash by 60% of the backlash range.

Miter spiral bevel gears are similar to straight bevel gears because the backlash setting should also be by increasing or reducing the pinion cone (P) and the gear cone (G) by equal amounts. Shifting only one of both will also change the

contact pattern position. In case of small changes within the tolerances (Table 4) (equal for pinion cone P and gear cone G) the contact movements are within permissible limits.

In Table 5 the shaft positioning tolerances for average spiral bevel gears with a ratio in the vicinity of 3 are documented. Also, for the spiral bevel gear offset tolerances, E has equal positive and negative values because in both directions an increase of backlash can be noticed. In case of the pinion cone P tolerance, negative values are not permitted because of the risk of tooth jamming (similar to straight bevel gears, see Table 3). The gear cone G can be used for the adjustment of the gearset's backlash and has an equal positive and negative shaft positioning tolerance. The shaft angle tolerance always follows the same rule as explained with straight bevel gears (Table 3).

Also, the tooth contact displacement values for the given tolerances are equal to straight bevel gears. Although the tooth contact pattern position of spiral

bevel gears reacts less sensitively to shaft deflections or positioning errors, the tolerances in Table 6 are very similar to the tolerances for straight bevel gears. The reason for this is the equal reaction to backlash changes, which is for both straight and spiral bevel gears, the limiting factor with respect to the shaft positioning tolerances.

For hypoid gearsets (Table 6), the offset tolerance E only allows positive deviations, as already small amounts of negative offset deviations would diminish the backlash rapidly. The tolerances for pinion cone P, gear cone G and shaft angle ALPHA are identical to spiral bevel gears. Different from spiral bevel gears is the contact displacement, which is 30% to 40% less for hypoid gears. The reason is 1) part that the tolerance in E direction is only positive and 2) that hypoid gears are typically less sensitive than spiral bevel and straight bevel gears.

The last bevel gear category covered in Table 7 of this guideline is super reduction hypoids (SRH). While the tolerance in offset (E) is equal to hypoid gears, the pinion cone tolerance (P) has a plus/minus value because of the slim pinion cone, which has only a very small influence on the backlash. The gear cone tolerance (G) is smaller than for hypoid gears, which is justified with the higher sensitivity regarding top-root contact and fillet transition interference. SRHs have the same shaft angle tolerances as all other bevel gear types, and contact displacement limits are identical to spiral bevel gears.

### Application of the Tolerances

The tolerance values in the tables for the specific gear types have been defined independently from each other to change the backlash not more than 50% of the backlash range defined in Table 1. If, for example, the entire negative tolerance for the root angle (ALPHA) and for the gear cone (G) is used simultaneously, then the backlash would be below the recommended minimal value; however, there will still be acceptable backlash available.

If a manufacturer can accept a

Module	2mm	4mm	6mm	12mm
E + (no minus)	0.025mm	0.050mm	0.075mm	0.150mm
P + (no minus)	0.020mm	0.040mm	0.060mm	0.120mm
G +/-	0.011mm	0.022m	0.033mm	0.066mm
ALPHA +/-	0.035°/0.020°	0.035°/0.020°	0.035°/0.020°	0.035°/0.020°
Contact Displacement +/-	0.3mm	0.6mm	1.0mm	2.0mm

Module	2mm	4mm	6mm	12mm
E + (no minus)	0.025mm	0.050mm	0.075mm	0.150mm
P +/-	0.020mm	0.040mm	0.060mm	0.120mm
G +/-	0.008m	0.016m	0.024mm	0.048mm
ALPHA +/-	0.035°/0.020°	0.035°/0.020°	0.035°/0.020°	0.035°/0.020°
Contact Displacement +/-	0.5mm	1.0mm	1.5mm	3.0mm

Direction	E	P	G	ALPHA
Straight & Spiral Miter	100% of Table Value	60% of Table Value	60% of Table Value	50% of Table Value
Straight & Spiral Ratio 2 to 5	100% of Table Value	75% of Table Value	55% of Table Value	50% of Table Value
Hypoid Ratio 2 to 5	100% of Table Value	75% of Table Value	60% of Table Value	60% of Table Value
SRH Ratio 5 to 50	100% of Table Value	100% of Table Value	60% of Table Value	60% of Table Value

backlash range which is twice the range shown in Table 1, then all the shaft positioning tolerances from the tables can be directly transferred in the housing print. If a manufacturer likes to control the backlash within the range of Table 1, then the values of the combined tolerances for the housing print have to be calculated by applying the axis-specific percentages from Table 8.

There are dependent and independent axis directions. The offset tolerance is independent from all other tolerances for all non-hypoid bevel gearsets because no backlash change can be noted within the amounts indicated in the tables. Pinion cone (P), gear cone (G) and shaft angle ALPHA are dependent axis directions because all three have an influence on the backlash. Table 8 considers the severity of these influences and recommends using only a specified percentage of the original, independent Table values. 

### References

- [5] DIN 3964 “Deviations of Shaft Center Distances and Shaft Position Tolerances of Casings for Cylindrical Gears,” Published by DIN Deutsches Institut für Normung e.V., Berlin, 1980.
- [1] Stadtfeld, H.J. “Gleason Bevel Gear Technology - The Science of Gear Engineering and Modern Manufacturing Methods for Angular Transmissions,” Expert Publishing, 2017, ISBN 978-3-8169-3283-3, Pages 357 to 373.
- [6] N. N. “Bevel and Hypoid Gear Design,” Company Publication, The Gleason Works, SD 3160-Feb. 1972-CAT, February 1972.



# Our Librarian Will Never Shush You at the **GT LIBRARY**

## **Dr. Hermann J. Stadtfeld**

is the Vice President of Bevel Gear Technology and R&D at the Gleason Corporation and Professor of the Technical University of Ilmenau, Germany. As one of the world's most respected experts in bevel gear technology, he has published more than 300 technical papers and 10 books in this field. Likewise, he has filed international patent applications for more than 60 inventions based upon new gearing systems and gear manufacturing methods, as well as cutting tools and gear manufacturing machines. Under his leadership the world of bevel gear cutting has converted to environmentally friendly, dry machining of gears with significantly increased power density due to non-linear machine motions and new processes. Those developments also lower noise emission level and reduce energy consumption.

For 35 years, Dr. Stadtfeld has had a remarkable career within the field of bevel gear technology. Having received his Ph.D. with summa cum laude in 1987 at the Technical University in Aachen, Germany, he became the Head of Development & Engineering at Oerlikon-Bührle in Switzerland. He held a professor position at the Rochester Institute of Technology in Rochester, New York from 1992 to 1994. In 2000 as Vice President R&D he received in the name of The Gleason Works two Automotive Pace Awards—one for his high-speed dry cutting development and one for the successful development and implementation of the Universal Motion Concept (UMC). The UMC brought the conventional bevel gear geometry and its physical properties to a new level. In 2015, the Rochester Intellectual Property Law Association elected Dr. Stadtfeld the "Distinguished Inventor of the Year." Between 2015–2016 CNN featured him as "Tech Hero" on a Website dedicated to technical innovators for his accomplishments regarding environmentally friendly gear manufacturing and technical advancements in gear efficiency.

Stadtfeld continues, along with his senior management position at Gleason Corporation, to mentor and advise graduate level Gleason employees, and he supervises Gleason-sponsored Master Thesis programs as professor of the Technical University of Ilmenau—thus helping to shape and ensure the future of gear technology.

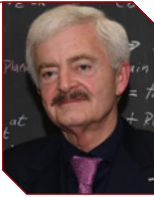

**That's because the MICHAEL GOLDSTEIN GEAR TECHNOLOGY LIBRARY is all online, and you can visit it anytime. Just go to [www.geartechnology.com](http://www.geartechnology.com) and use the search box for access to 36 years of technical content focused on gears.**

- **Every issue since 1984**
- **More than 2,000 technical articles**
- **More than 6,000 archived news items**
- **Addendum, Publisher's Page, Back to Basics and more**

**And the best news of all? You don't even need a library card. That's because the GT LIBRARY is open to everyone. Knowledge is free. All you have to do is go and get it.**

[www.geartechnology.com](http://www.geartechnology.com)

# Calculated Scuffing Risk: Correlating AGMA 925-A03, AGMA 6011-J14 and Original MAAG Gear Predictions

John Amendola, John Amendola III, and Robert Errichello

## Introduction

This paper relates specifically to gears that are finish ground and considered high speed per ANSI/AGMA 6011; meshing elements with PLVs (pitch line velocities) in excess of 35 m/s or rotational speeds greater than 4,500 rpm (Ref. 1).

Current application standards by AGMA & ISO both provide methods for rating gears for macropitting and bending fatigue. However, neither have a standard to calculate scuffing risk. Both have provided documents; AGMA 925-A03 and ISO/TS 6336-20 (formally ISO/TR 13989-1) as informative suggestions to consider scuffing risk in gear design. Nevertheless, scuffing requires the same consideration as macropitting and bending in rating gears — especially in high-speed applications with high sliding velocities.

Scuffing is not a fatigue phenomenon and may occur instantly, often during early stages of operation. This failure is directly related to the lubricant oil film, which does not adequately separate the surfaces. Figure 1 is a classic example of gear tooth scuffing. One or more of the following are typical root causes for scuffing:

- The threshold for scuffing resistance may not have been considered when designing the geometry of the gearset. For example, excessive sliding velocities occurring between the meshing elements.
- The lubricant selected was not in accordance with the original

lubricant intended for the application.

- The load distribution along the tooth flanks did not consider mechanical (elastic) deflection and thermal deformation resulting in either non-uniform load or less than full face width loading along the entire flank at full load.
- The surface roughness of the gearset was excessive.
- Operational oil inlet temperature was excessive.

## Background

In 1937 Harmon Blok published his theory about the relationship between contact temperature and scuffing, which was presented at the Second World Petroleum Congress held in Paris, June, 1937 (Ref. 3).

This subject went largely unnoticed in the U.S. until the early 1950's (Ref. 2).

Until that time most high-speed gears produced in the U. S. were through hardened, which did not require a calculation for scuffing. While scuffing distress in case hardened gears had been recognized for a fairly long time, in earlier times it was often referred to as scoring. This was incorrect as scoring is an abrasive action with surfaces scratching each other during engagement, whereas scuffing is an adhesive action where transfer of metal from one surface to the other occurs due to welding and subsequent tearing. In 1963 MAAG identified it as "hot scoring," thus separating the nature of these actions of distress. With the publication of AGMA 925-A03, the difference was made clear that an adhesive action is referred to as scuffing.

Two schools of thought emerged; 1) the flash temperature criterion according to Blok based on the highest momentary local maximum temperature, and 2) the integral temperature criteria, which is based on the integrated temperature along the path of contact arriving at a steady average gear tooth temperature. Blok's flash temperature criteria has been the adopted practice in AGMA standards, much in parallel with MAAG's work first recorded in the early 1960's.

While the scuffing mechanism is now clearly understood, what remains uncertain is how to assess risk on a given gear unit. Aside from operating environmental changes such as deterioration of good flank load distribution, quality of lubricant in service, operational changes such as load and speed, assessment of scuffing risk for a new installation has been the widely favored evaluation method using the maximum flash temperature as the critical factor. This document presents examples of assessing scuffing risk for high-speed gears applying three methods of calculating the scuffing criteria. The comparable results demonstrate all three methods are effectively credible for



Figure 1 Scuffing example.

calculating scuffing risk.

Blok's theory is based on what is termed "flash temperature." Professor Blok's definition states scuffing will occur when the local temperature at the point of contact rapidly rises (flashes) due to friction at the tooth contact point. This momentarily raises the lubricant temperature above the lubricant's ability to maintain its viscosity.

Blok's criteria that limit sliding velocity are directly related to the local temperature occurring in the contact area of the gear teeth. This temperature—termed as the "flash temperature"—can be calculated for any local point on the involute along the path of contact. The maximum flash temperature calculated becomes the design point to which a gearset is rated for its maximum power transmission capability against scuffing. Under operational conditions, scuffing is influenced by a combination of the film thickness and the coefficient of friction, dependent on surface pressure and sliding velocity. High-speed gears are subject to higher sliding velocities. The highest velocity occurs at the SAP (beginning—Start of Active Profile) and EAP (end—End of Active Profile) of the tooth contact path.

According to Professor Blok the governing temperature peak is obtained by adding the flash temperature to the mean temperature of the tooth flanks before entering the contact zone. This value is called the total contact temperature. Therefore, the total contact temperature is the sum of two components: the flash temperature and the tooth body temperature (Ref. 13).

$$\theta_{\text{total contact max}} = \theta_{\text{flash max}} + \theta_{\text{tooth temp}} \quad (1)$$

Where

- $\theta_{\text{total contact max}}$  is total contact temperature;
- $\theta_{\text{flash max}}$  is flash temperature is the instantaneous temperature rise over and above the steady tooth flank temperature;
- $\theta_{\text{tooth temp}}$  is tooth temperature (non-loaded flank temperature) can be defined as the steady surface temperature of the contacting body.

This so-called flash temperature should not be confused with the actual flash temperature of a lubricant. The flash point is the lowest temperature to which a lubricant must be heated before its vapor, when mixed with air, will ignite but not continue to burn. The flash point of most ISO VG 32 R&O mineral oils is in the 370°–390°F (188°–199°C) range (Ref. 10).

**Stribeck curve.** The Stribeck curve, originally developed for journal bearings (Fig. 2), expresses how the coefficient of friction varies over the entire range of lubrication.

For high-speed gears, the sliding velocity becomes a greater factor when compared to speed overall, including the hydrodynamic, mixed, and boundary lubrication regimes. These regimes are noted by the vertical dotted lines and are described as regimes of lubrication 1, 2, 3 that directly affect the fatigue life of the gear teeth relative to surface distress. The effects of this phenomenon were introduced by Richard Stribeck while conducting research in

the field of Tribology (Ref. 11).

The three regimes of lubrication are as follows:

**Regime I:** Only boundary lubrication exists with essentially no EHL film, and contact of the asperities of gear flanks in motion relative to one another is pronounced.

**Regime II:** Partial EHL oil film is developed and there is occasional contact of the asperities of gear flanks in motion relative to one another.

**Regime III:** Full EHL oil film is developed and separates the asperities of gear flanks in motion relative to one another (Ref. 2).

**NOTE:** For gears, beyond the boundary between Regime II and Regime III, the friction coefficient effectively decreases.

## Development of Application Methodology

The original formula derived by Professor Blok for the "flash temperature" is derived from the assumption that the heat source, having a uniform distribution inside a defined contact area (semi-width of the Hertzian contact band), moves along the tooth flank with a constant speed. In that way, the tooth flank receives the entire source heat flow. The original expression by Professor Blok (Ref. 3) was published by Dr. Wydler as follows: (Ref. 13).

$$\theta_{fl(i)} = 0.83 \frac{f_{(i)} P_1 \times [V_1 - V_2]}{[B_{m1} V_1^{0.5} + B_{m2} V_2^{0.5}] \times R^{0.5}} \quad (2)$$

where

- $\theta_{fl(i)}$  is flash temperature, °C;
- $f_{(i)}$  is instantaneous coefficient of friction;
- $P_1$  is specific loading, kg/cm;
- $V_1, V_2$  Flank speeds perpendicular to the line of action, cm/sec;
- $B_{m1}, B_{m2}$  Heat dissipation characteristics—thermal coefficient of steel;
- $R^{0.5}$  Semi-width of Hertzian contact band, cm.

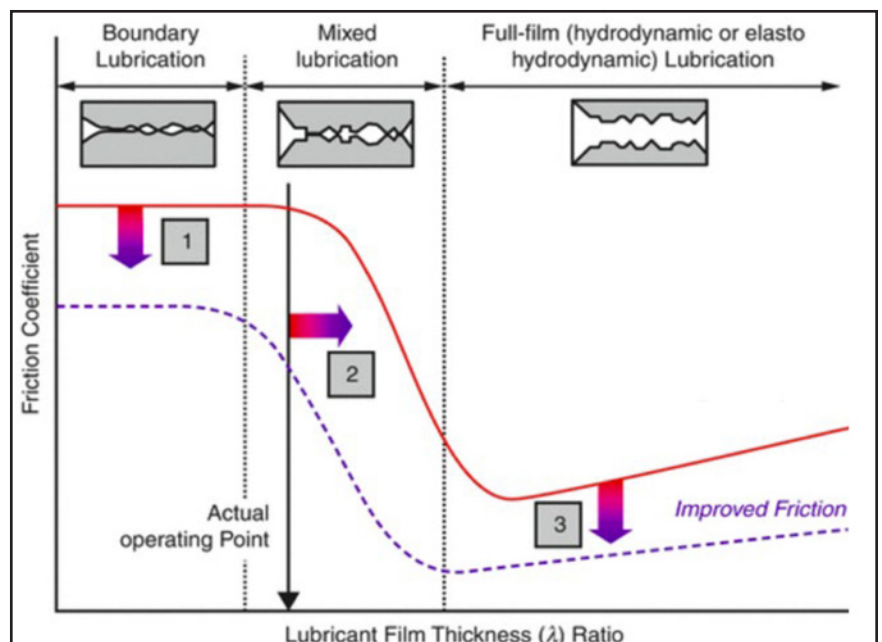

Figure 2 Stribeck curve. (Source: Wang Q.J., Chung YW, "Encyclopedia of Tribology." (2013) Springer, Boston, MA.)

Kelley later modified Blok's flash temperature equation by considering the influence of surface roughness (Ref. 11), and Dudley modified Kelley's equation by considering the loading actually applied on the gear tooth flank (Ref. 4). This modification was later adopted by AGMA-925-A03 in the current form:

$$\theta_{\beta(i)} = 31.62 K \mu_{m(i)} \frac{X_{\Gamma(i)} w_n}{(b_{H(i)})^{0.5}} \times \frac{|v_{r1(i)} - v_{r2(i)}|}{B_{m1}(v_{r1(i)})^{0.5} + B_{m2}(v_{r2(i)})^{0.5}} \quad (3)$$

where

- $\theta_{\beta(i)}$  is flash temperature, °C;
- $K$  is 0.80, numerical factor valid for a semi-elliptic (Hertzian) distribution of frictional heat over the instantaneous width,  $2 b_{H(i)}$ , of the rectangular contact band;
- $\mu_{mi}$  is coefficient of friction;
- $X_{\Gamma(i)}$  is load sharing factor;
- $w_n$  is normal unit load, N/mm;
- $b_{H(i)}$  is semi-width of Hertzian contact band, mm;
- $v_{r1(i)}$  is rolling tangential velocity of the pinion, m/s;
- $v_{r2(i)}$  is rolling tangential velocity of the wheel, m/s;
- $B_{m1}$  is thermal contact coefficient, pinion, N/[mm s<sup>0.5</sup>K];
- $B_{m2}$  is thermal contact coefficient, wheel, N/[mm s<sup>0.5</sup>K].

**NOTE:** subscript "i" = denotes a point on the line of action (Ref. 11).

Numerous methods of determining the propensity for scuffing have evolved and led us into today's methodology, as found in AGMA 925 and ISO/TS 6336-20. The evolution of some of these methods can be summarized in the following sections.

**MAAG method 1963.** In 1963 MAAG developed a simplified procedure to assess scuffing risk according to the flash temperature criteria based on the following relationship:

$$F_{load63} = w^{*'} \left( \frac{\sqrt[4]{v'}}{\sqrt{a'}} \right) \quad (4)$$

Where

- $F_{load63}$  is permissible operating load, kg/mm;
- $w^{*'}$  is unit loading, kg/mm;
- $v'$  is pitch line velocity, m/s;
- $a'$  is center distance, mm.

Formulation for application using SI units  $w^{*'} = w'/9.81$  to be used with Figure 3. Figure 3 was published by MAAG 1963 handbook for general use in the industry, primarily in assessing scuffing risk for high-speed gears (Ref. 8).

**Wydler method — 1972.** On the strength of experience gained in high-capacity gear design, the following relationship between the scuffing limit, load and speed had been determined (Ref. 13).

$$\theta_{\beta(lim)} \approx Power \cdot \sqrt[4]{v} \quad (5)$$

Where

- $\theta_{\beta(lim)}$  is flash temperature at scuffing limit, °C;
- $v$  is pitch line velocity, m/s.

It is difficult to predict the coefficient of friction for high-speed applications, but it is a proportionate function to speed and load. In high-speed gears Dr. R. Wydler investigated tests conducted by Hughes and Waight (Ref. 5). From this it was determined that at higher speeds, due to the improved load carrying capacity with full hydrodynamic lubrication, the influence of speed on scuffing was lessened. It was also determined that the proportional relationship with speed and load influenced the coefficient of friction in a proportional manner according to:

$$\sqrt[4]{\frac{load}{speed}} \quad (6)$$

At lower loads and speeds the frictional relationship varies (Ref. 13).

For this calculation method it is assumed that the highest flash temperature occurs at the tooth tip for an unmodified profile.

Based on the limited experience at the time and using  $Ra = 0.48$ , Wydler set up conservative permissible scuffing limits  $\theta_{\beta(lim)} = 140^\circ\text{C}$  for a typical ISO VG 32 oil, and  $\theta_{\beta(lim)} = 156^\circ\text{C}$  for ISO VG 46 (Ref. 13).

In summary, this method contains a considerable, but not precisely known, safety margin, for it embraces the practical conditions of high-speed, high-capacity gear drives.

**Integral temperature method 1983.** AGMA 925-A03 refers to Winter and Michaelis, who published a paper on scuffing where they introduced a method to assess scuffing by the integral temperature method. In AGMA 925-A03 the integral temperature method was mentioned as an alternate method to the flash temperature method. This method involves the calculation of a scuffing load basically independent of speed, but controlled by gear geometry. Application of the method requires comparison of the proposed gearset based on a test rig result to a known test rig gearset and

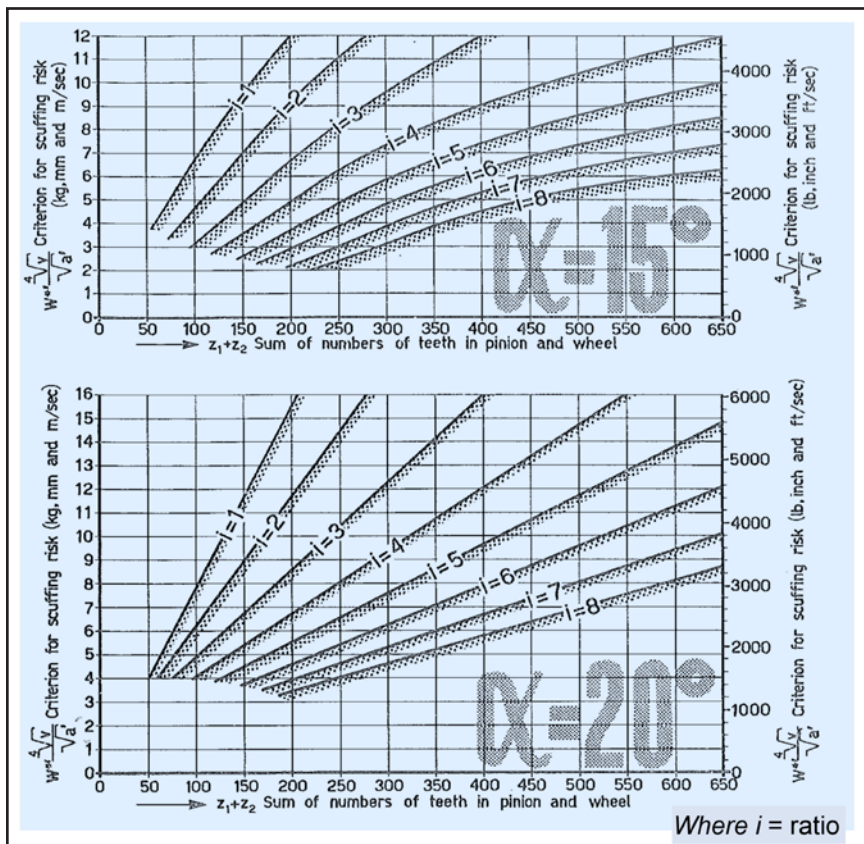

Figure 3 MAAG 1963 Handbook assessing scuffing.

tested oil. A comparison of the flash temperature method and integral temperature method has shown the following: Blok's method and the integral temperature method give essentially the same assessment of scuffing risk for most gearsets; Blok's method and the integral temperature method give different assessments of scuffing risk for those cases where there are local temperature peaks. These cases usually occur in gearsets that have low contact ratio, contact near the base circle, or other sensitive geometries. Blok's method is sensitive to local temperature peaks because it is concerned with the maximum instantaneous temperature, whereas the integral temperature method is insensitive to these peaks since it averages the temperature distribution (Ref. 2).

An application of the integral temperature method can now be found in ISO/TS 6336-21, based on a rig testing gears running at pitch line velocities less than 80 m/s. The integral temperature method was first presented in ISO/TR 13989-2. It averages the flash temperature and supplements empirical influence factors to the hidden load sharing factor. The resulting value approximates the maximum contact temperature, thus yielding about the same assessment of scuffing risk as the flash temperature method of this part of ISO/TR 13989, now ISO/TS 6336-20.

The equations might be used for gears which run at higher speeds, but with increasing uncertainty as speed increases. The integral temperature method is less sensitive for those cases where there are local temperature peaks, usually in gearsets that have low contact ratio or contact near the base circle or other sensitive geometries (Ref. 6). Furthermore, ISO/TS-6336-20 states the methodology is based on tested gears operated at pitch line velocities less than 80 m/s, with increased uncertainty at speeds in excess of experimental limits.

This paper reaffirms the flash temperature method is preferred for assessing scuffing risk for high-speed gears.

## Current Comparative Methods of Determining the Propensity of Scuffing

**ANSI/AGMA-6011 Annex B (MAAG method 1963/1983 mod) — simplified scuffing criterion method.** With twenty years of experience, MAAG broadened the approach to verifying scuffing resistance. Instead of approximating the probability of risk using a set of curves, MAAG developed a simplified calculation procedure that compares an applied load function  $F_{load}$  against a calculated value  $F_{geom}$ , according to the calculation procedure in the MAAG gear book 1963 establishing a rule:

$$F_{load} < F_{geom} \quad (7)$$

Where  $F_{load}$  assumed a straight mineral oil of viscosity ISO VG 32, the definition was expanded to apply to oils with other viscosities in centistokes. Therefore:

$$F_{load} = w' (\sqrt[4]{v}) \left[ 6 \sqrt{\frac{46}{v}} \right] \quad (8)$$

Where

$w'$  is specific tooth load on the operating pitch circle, N/mm;

$v'$  is pitch line velocity, m/s;

$v$  is viscosity, cSt @ 40°C;

$F_{geom}$  is based on the gear size, numbers of teeth, and rotor size based on center distance; the coefficient of friction assumes an  $R_a = 0.4$ .

$$F_{geom} = \frac{(50 + z_1 + z_2)(a)^{0.5}}{A} [Cu] \quad (9)$$

Where

$z_1$  is number of teeth of the pinion;

$z_2$  is number of teeth of the gear;

$a$  is center distance, mm;

$A$  is taken from Table 1;

$C_u$  is taken from Table 1.

**Table 1 Values A and  $C_u$  for calculating F (geometric)**

$a$	$A$	$C_u$ at $1 \leq u < 3$	$C_u$ at $3 \leq u \leq 10$
15	350	$95 + 28.6(3-u)$	$130 - 10 [112.5 - (13-u)^2]^{0.5}$
17.5	300	$90 + 30(3-u)$	$120 - 10 [90 - (12-u)^2]^{0.5}$
20	300	$100 + 33.3(3-u)$	$130 - 10 [109 - (13-u)^2]^{0.5}$
22.5	250	$95 + 28.5(3-u)$	$130 - 10 [112.5 - (13-u)^2]^{0.5}$
25	250	$105 + 31.4(3-u)$	$140 - 10 [133.5 - (14-u)^2]^{0.5}$

Notes:

$a$  is normal pressure angle, degrees;

$u$  is gear ratio ( $z_2/z_1$ )

This method was later refined with additional experience of 15 years, allowances for toothing accuracies, experience with flank modifications, increased knowledge of thermal influences on the tooth flanks, and improved quality of lubricants. Calculations as described in MAAG Handbook 1983 added a rating factor in the formula for  $F_{load}$  to permit higher  $F_{geom}$  values. These were first published in ANSI/AGMA 6011-H98 (Ref. 1).

$$F_{load} = \frac{w'}{C_w} (\sqrt[4]{v}) \left[ 6 \sqrt{\frac{46}{v}} \right] \quad (10)$$

Where,  $C_w$  is risk factor:

1.10 - Conservative value;

1.15 - Nominal value;

1.20 - Maximum value.

**AGMA 925-A03/MAAG method 1983 — differentiated calculation procedure.** There is uncertainty concerning the estimation of the "bulk" tooth temperature, coefficient of friction, and allowable temperatures as speeds exceeded the range with experimental background. High-speed gears are defined in AGMA as gear operating above 35 m/s or pinion speed above 4,500 rpm. As an example, 80 m/s is significantly greater than the AGMA threshold, but it is well below high-speed applications that are commonly up to 175 m/s or greater. A reliable method applied for all the high-speed applications is an important consideration for calculating scuffing risk.

**NOTE:** 80 m/s is referenced in the following section as a starting threshold for an increased heat source in the gear mesh.

The derivation of absolute allowable flash temperature limits has been established with FZG gear test rigs. However, their determination has been accumulated with the use of relatively small gears. These gears will develop heat characteristics unlike real-world high-speed gears that are larger in size. To apply a base for scuffing assessment that reflects real gears rather than test gears, the total contact temperature requires a value for the base tooth body temperature. With this method it was realized that the calculation of the steady tooth bulk temperature is complex and is therefore beyond a routine calculation procedure. Thus, MAAG applied the integral temperature criteria establishing a base temperature among all real high-speed gears of 100°C, this can be allowed for by substituting the value of the dynamic viscosity  $\eta_M$  at this temperature for determination of

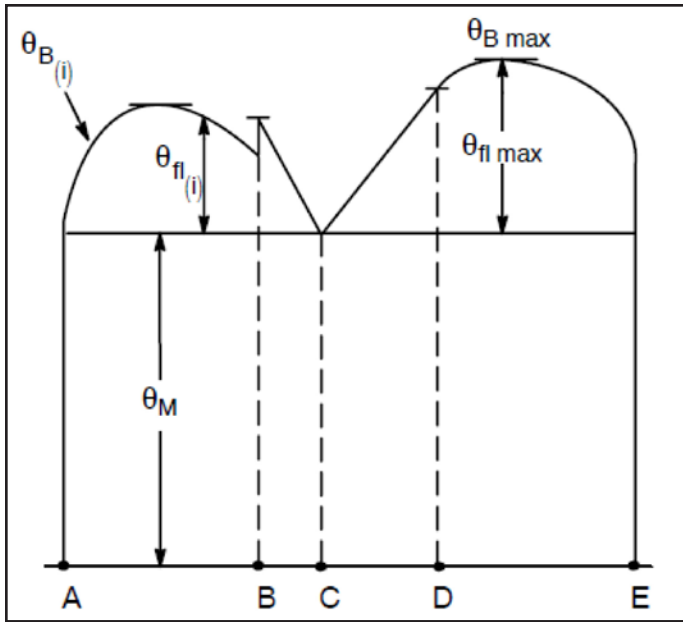

Figure 5 Contact temperature along the line of action.

the coefficient of friction (Ref. 9).

Sometimes the tooth temperature is referred to as the tooth bulk temperature or body temperature. This can be misleading. The surface or flank temperature of the non-drive flank better defines the tooth temperature.

Carlos Wink conducted an experimental study to predict scuffing risk applying AGMA 925-A03 in terms of calculation of the tooth temperature. The results indicated that AGMA 925-A03 is indeed effective and consistent in predicting scuffing risk. Tooth flank temperature was estimated (Ref. 12):

$$\theta_{tooth\ flank} = k_{sump} \theta_{oil} + 0.56 \theta_{flmax} \quad (11)$$

where

$\theta_{tooth\ flank}$  is  $\theta_M$  from Figure 5;

$k_{sump}$  is 1 for splash lube and 1.2 for spray lube;

$\theta_{oil}$  is oil supply or sump temperature in °C;

$\theta_{flmax}$  is the maximum flash temperature found over all line-of-contact points.

Recalling the contact temperature is the sum of the flash temperature and the tooth body temperature:

$$\theta_{Btotal\ contact\ max} = \theta_{flmax} + \theta_{tooth\ flank} \quad (12)$$

At no point in the contact zone must the flash temperature be allowed to exceed a maximum permissible value (Ref. 8).

MAAG's differentiated calculation procedure does not provide criteria for risk assessment. Variables that are unique to each gear unit manufacturer have significant impact on risk assessment. These include size (small gears heat up more than large gears), flank surface roughness, thermal deformations of the gears during operation

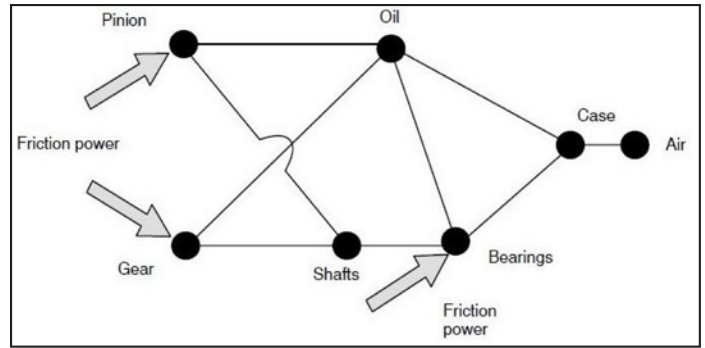

Figure 4 Identifying the thermal network in a gearbox.

(changing the load distribution across the face width and between several teeth).

Therefore, MAAG suggests experience with statistical investigation is required to develop reliable limit values for practical use (Ref. 9).

AGMA 925-A03. This document addresses several forms of gear tooth surface distress applying various methods and provides an elementary risk assessment omitted in the MAAG differentiated calculation procedure.

AGMA 925 permits the applicant or designer use of specific values that are variable in assessing scuffing risk. This provides a more precise answer to determining the risk assessment. AGMA 925 can be applied to gears of variable sizes, speeds, and configuration. ANSI/AGMA 6011 is specific for high-speed gears and many of the parameters are fixed for assessing risk in high-speed applications.

AGMA 925 addresses the importance of determining the tooth temperature with analysis of the heat flow balance in the gearbox. As stated, there are several sources of frictional heat, of which the most important ones are the tooth friction and the bearing friction; other heat sources, like seals and oil flow, may also contribute. For gear pitch line velocities above 80 m/s, churning loss, expulsion of oil between meshing teeth, and windage loss become important heat sources that should be considered. Heat is conducted and transferred to the environment by conduction, convection and radiation (Ref. 2).

An example of identifying the thermal network in a gearbox is depicted in Figure 4.

Table 2 Parametric Comparison			
	AGMA-6011 (MAAG Method 1963/1983 modified Simplified Scuffing Criterion)	AGMA 925-A03 modified MAAG 83 Differentiated Calculation Procedure	AGMA 925-A03
Oil Type	Mineral	Mineral	Variable †
Oil Viscosity	Variable	Variable	Variable †
Oil inlet temperature	Fixed	Fixed	Variable †
Surface Roughness	Fixed	Variable	Variable †
Combination of trapezoidal loading	Fixed (Smooth meshing)	Fixed (Smooth meshing)	Calculated †
Coefficient of friction*	Fixed	Calculated	Calculated
Tooth flank surface (bulk) temperature**	100 °C	100 °C	Calculated
Thermal Coefficient of Contact for Steel***	Fixed	Fixed	Fixed
FZG Oil Load Stage	Fail 6	Fail 6	Fail 6

\*This value accounts for changing tooth geometries resulting from modules fitted with number of teeth and center distance.

\*\*This is derived from the tooth temperature which is a sum of the entire environment.

\*\*\*Thermal Coefficient of Contact for Steel Bm :13.796 N/(mm s<sup>0.5</sup> K)

† Refer to Table 2



Oil Type:	Mineral
Oil Viscosity:	VG 32
Inlet Oil Temperature:	70 °C
Surface roughness, Ra:	0.48 µm
LSF (load sharing factor):	smooth meshing/with profile modification
Thermal Coefficient of Contact for Steel B	13.796 N/[mm s <sup>0.5</sup> K]

AGMA 925 defines the contact temperature as described earlier by Professor Blok and repeated in MAAG methodology.

The scuffing risk is calculated to very similar criteria as described in MAAG 1983 for  $C_w$ :

**Probability of scuffing risk:**

- <10% Low (for this paper authors consider <5% as low threshold)
- 10 to 30% Moderate
- >30% High (Ref.2)

**Setting the Parameters**

A comparison of the risk assessment is as follows:

AGMA-925-A03: In order to create a comparatively close alignment of the subsequent example calculations it was necessary to pre-define those variables with the following fixed parameters. Parameters fixed for the comparison of different operating units are listed in Table 3. The data input for each installation is listed in Table 4.

**Example Reference Calculations**

**NOTE:** For added evaluation in assessing risk, a margin of risk has been created for Table 5 through Table 7 and is defined as follows:

$$MR(\%) = \left[ \frac{F_G - F_L}{F_G} \right] \times 100 \quad (12)$$

Where

- MR is margin of risk %;
- $F_G$  is allowable geometry load;
- $F_L$  is rated transmitted load.

**Discussion**

This presentation showing nine examples and applying the three methods of calculating scuffing risk are in general agreement; this supports their mutual credibility. These examples, however, involved applications specific to high-speed gears. Conditions vary for other applications and the results may not produce consistent results.

AGMA 925 -A03 has been calculated applying two procedures. Results by the differentiated calculation procedure are summarized in Table 8 and the empirical calculation procedure in Table 9. The calculation of the steady bulk temperature is complicated and beyond a routine calculation procedure (Ref.9). So the

Ex. Ref.	est. op hrs	Helical	Type	CD	FW	PLV	Kw	Input (rpm)	Output (rpm)	Module	Z <sub>1</sub>	Z <sub>2</sub>
1	>200k	single	increaser	400	236	142.0	10,515	4,831	11,406	6.5000	36	85
2	120k	double	decreaser	360	228	112.0	7,915	8,476	4,573	5.5000	41	76
3	175k	single	increaser	250	120	118.3	4,096	6,840	13,310	4.5000	37	72
4	160k	single	decreaser	580	502	109.3	37,286	4,670	2,927	6.2500	47	75
5	180k	single	increaser	520	352	142.1	22,670	3,428	10,933	6.5000	37	118
6	200k	single	increaser	780	255	123.0	13,500	1,775	9,951	7.0000	33	185
7	150k	double	increaser	610	370	92.7	16,406	1,800	7,636	6.0000	33	140
8	150k	single	increaser	509	323	72.6	12,304	1,800	5,606	6.9000	35	109
9	120k	single	increaser	600	270	88.1	9,694	1,800	7,582	5.9000	37	163

Ref.	Sliding Velocities (m/s)				max. Hertzian contact stress N/mm <sup>2</sup>	Max coefficient of friction* $\mu_{(max)}$	Min. specific film thickness $\lambda_{2bH}$ (µm)
	SAP $V_{s1A}$	LPSTC $V_{s1B}$	HPSTC $V_{s1D}$	EAP $V_{s1E}$			
1	24.78	2.06	8.30	31.02	585.71	0.0613	2.07
2	16.72	5.47	7.64	18.89	580.33	0.0561	1.87
3	21.54	2.64	6.88	25.78	683.90	0.0632	1.99
4	16.77	3.51	5.25	18.50	711.02	0.0787	1.72
5	20.40	3.91	8.94	25.43	606.78	0.0666	2.19
6	18.10	0.14	7.82	25.78	630.43	0.0723	1.59
7	12.11	4.91	7.95	15.15	723.13	0.0835	1.39
8	11.33	1.52	4.68	14.49	757.99	0.0824	1.08
9	13.35	0.38	4.81	18.54	640.00	0.0721	1.28

\*calculated at the highest contact temperature

\*\*NOTE: references, 4, 7, 8, 9 have had experiences of surface distress.

Reference	Notes:
1	
2	
3	
4	history of scuffing was corrected, modified spray bar and lead correction
5	
6	
7	history of scuffing was corrected, modified spray bar and lead correction
8	latent micropitting history no solution
9	latent micropitting history currently under investigation

NOTE: For added evaluation in assessing risk a margin of risk has been created for Table 5 through Table 7 and is defined as follows:

Ref.	Wydler	Maag 1963	(NO account for profile modification)		
	Flash Temp Pinion °C	Flash Temp Wheel °C	Allowable °C	Margin °C	Risk
1	111.0	106.0	140.0	20.7%	SAFE
2	135.0	129.0	140.0	3.6%	SAFE
3	118.0	115.0	140.0	15.7%	SAFE
4	135.0	129.0	140.0	3.6%	SAFE
5	93.0	82.0	140.0	33.6%	SAFE
6	144.0	122.0	140.0	-2.9%	At Risk!
7	144.0	119.0	140.0	-2.9%	At Risk!
8	145.0	131.0	140.0	-3.6%	At Risk!
9	122.0	108.0	140.0	12.9%	SAFE

Ref.	Nageli	Maag 1983	Simplified	Scuffing	Criterion
	Cv = 1.0				
	with profile modification /Nominal Risk Cv=1.00				
	Load N/mm <sup>2</sup>	Geometry N/mm <sup>2</sup>	margin %	risk	tooth temp °C
1	1172.0	1382.5	15.2%	SAFE	100
2	2254.6	2026.4	-11.3%	AT RISK!	100
3	1030.8	1132.1	8.9%	SAFE	100
4	2254.6	2026.4	-11.3%	AT RISK!	100
5	1125.6	1469.4	23.4%	SAFE	100
6	1528.2	1404.2	-8.8%	AT RISK!	100
7	1603.1	1343.2	-19.3%	AT RISK!	100
8	1658.0	1406.8	-17.9%	AT RISK!	100
9	1307.2	1443.7	9.5%	SAFE	100

For historical reference tabulated results of the Maag 1963 method—Table 6 (was the basis used by Wydler Method—1972) and Nageli—1983 in Table 7 are summarized above.

simplified methods in MAAG “63”/“83” and ANSI/AGMA 6011-J14 (Ref.1) have fixed or adjusted parameters for that purpose.

Variable parameters that need to be considered for all applications that possibly minimally vary with high-speed gears:

- Elasto-hydrodynamic effect of the oil film dependent on pitch line velocity
- Lubricant employed
- Surface Roughness
- Gear tooth flank temperature
  - Influence on coefficient of friction
  - Maximum contact temperature
- Rotor material
  - Modulus of elasticity
  - Poisson’s ratio

This does not in any way suggest the application of these methods is not valid for other than high-speed applications. Rather, with the inclusion of parameters common with high-speed gears, all methods proved consistent results.

In the example Table 4 the maximum coefficient of friction,  $\mu_{(max)}$ , calculated at the highest contact temperature, resulted in the highest values.

A percentage of risk has been created for the ANSI/AGMA 6011-J14 (Ref.1) method. Currently it is effectively a go-no go assessment. The risk percentage provides a relationship when analyzing comparative data.

**Conclusions**

AGMA 925-A03 is intended for use for a wide range of gear applications in power, speeds and configuration. This includes a range of lube oil viscosity selected according to the application. The conditions for slow-speed gears — especially splash-lubricated — have an operating oil temperature that does not vary as greatly with the tooth body temperature as high-speed gears. Quality levels of the gearing are quite variable. It is clear that numerous options for assessing scuffing risk exist. Formulas for assessing such risk have been either empirically developed or based on testing. This is particularly true for determining the variable coefficient of friction, which has a large influence on the flash temperature calculation (Ref.9). In order to apply AGMA 925-A03 for high-speed applications the inlet temperature must be carefully selected. A 70°C inlet temperature was assumed, which provides results consistent with ANSI/AGMA 6011. Lower (or higher) values for oil inlet temperatures may produce unreliable assessment of risk.

The choice of the inlet temperature is based on typical field operating conditions of the referenced examples. Oil supply temperatures for high-speed gears are normally limited to 49°C with an allowable overall temperature rise of 29°C (Ref.9). The applied inlet temperature will therefore be somewhat less than 78°C. The supply temperature, which 925-A03 applies as the initial parameter in defining the tooth body temperature, may vary significantly. This can be a major divergence between assessing risk in comparing 925-A03 and 6011-J14. To align results consistently when applying 925-A03 to high-speed gears, an oil inlet temperature has been set to approximately 70°C. This selection is based on the thermal network of a gearbox described in Figure 6. An arbitrary choice 70°C seemed reasonable, resulting in a calculated tooth body temperature of approximately 100°C. MAAG “63”/“83” and ANSI/AGMA 6011-J14 (Ref.1) fixed the tooth body temperature at 100°C.

ANSI/AGMA 6011-J14 is specifically intended for use with high-speed gears that are subject to higher pitch line velocities, which typically employ lubricants with a viscosity range of 32–46 centistokes at 40°C. As previously mentioned, for gear pitch line velocities above 80 m/s, churning loss, expulsion of oil between meshing teeth, and windage loss become important heat sources that should be considered (Ref.9). Gear quality levels should be consistently high where particular attention must be paid to the influence of thermal deformations, (most notably above 100 m/s), affecting the change in load distribution across the face width and between several teeth (Ref.9). The calculation assumes addendum modified gears usual for high-speed gearing (Ref.9).

The calculation procedure developed by MAAG refrains from consideration of absolute flash temperature limits, since their determination is by testing with relatively small gears (such as

**Table 8 AGMA-6011 MAAG method 1983 modified — simplified scuffing criterion method**

Ref.	with profile modification /Nominal Risk Cv=1.15				
	Load N/mm <sup>2</sup>	Geometry N/mm <sup>2</sup>	Margin %	Risk	Tooth Temp °C
1	1019.1	1382.5	26.3%	SAFE	100
2	1960.5	2026.4	3.3%	SAFE	100
3	225.6	508.4	55.6%	SAFE	100
4	1960.5	2026.4	3.3%	SAFE	100
5	978.7	1469.4	33.4%	SAFE	100
6	1328.8	1404.4	5.4%	SAFE	100
7	1394.0	1343.2	-3.8%	AT RISK!	100
8	1441.7	1406.8	-2.5%	AT RISK!	100
9	1136.7	1443.7	21.3%	SAFE	100

**Table 9 Scuffing risk according to AGMA 925-A03 — differentiated calculation procedure**

**AGMA 925-A03 (MAAG Method 1983) — Differentiated Calculation Procedure**

Ref.	per MAAG Simplified Assumption Tooth Temp.=100°C					
	Scuffing Risk	Risk	Tooth Temp °C	Flash Temp °C	Contact Temp °C	Allowable °C
1	5.0%	Low	100	15.9	115.9	177.4
2	5.0%	Low	100	33.2	133.2	177.4
3	5.0%	Low	100	17.3	117.3	177.4
4	5.0%	Low	100	33.2	133.2	177.4
5	5.0%	Low	100	18.3	118.3	177.4
6	5.0%	Low	100	23.4	123.4	177.4
7	6.5%	Moderate	100	37.2	137.2	177.4
8	5.5%	Moderate	100	34.9	134.9	177.4
9	5.0%	Low	100	22.4	122.4	177.4

**Table 10 Scuffing risk according to AGMA 925-A03 — empirical method**

**AGMA 925-A03**

**per Benedict & Kelley Empirical Method**

Ref.	Scuffing Risk	Risk	Tooth Temp	Flash Temp	Contact Temp	Allowable
1	5.0%	Low	92.4	14.9	107.3	177.4
2	6.2%	Moderate	102.8	33.6	136.4	177.4
3	5.0%	Low	93.0	16.1	108.6	177.4
4	6.2%	Moderate	102.8	33.6	136.4	177.4
5	5.0%	Low	93.8	17.5	111.3	177.4
6	5.0%	Low	96.8	22.9	119.7	177.4
7	10.1%	Moderate	105.3	38.1	143.5	177.4
8	7.6%	Moderate	103.9	35.4	139.3	177.4
9	5.0%	Low	96.3	21.9	118.2	177.4

FZG testing). These small gears heat up quite differently than gears of larger dimensions that are ultimately employed in service (Ref. 9).

Looking ahead, surface distress due to scuffing or micropitting may be related; they share given parameters that may lead to either distress. Whereas micropitting is a fatigue phenomenon, scuffing is not, but rather occurring instantaneously. It is suggested that scuffing is a condition where the subsequent surface distress occurs when the lambda ratio is entirely in regimes 1 and 2, whereas micropitting occurs when the lambda ratio is in the borderline regimes 2 and 3. High FZG-rated lubricants provide scuffing resistance, but over time fatigue of the surface asperities may result in micropitting. 

### For more information.

Questions or comments regarding this paper? Contact John Amendola at [jamendola@artec-machine.com](mailto:jamendola@artec-machine.com).

### References

1. ANSI/AGMA 6011-J14; Forward, Annex B., January, 2014.
2. AGMA 925-A03, Forward, pages 17–21, 24, January, 2013.
3. Blok, H. "Les Températures de Surface dans les Conditions de Graissage sans Pression Extrême," *Second World Petroleum Congress*, Paris, June, 1937.
4. Dudley, D.W. "Practical Gear Design," McGraw Hill, 1954.
5. Hughes and Waight. "The Lubrication of Spur Gears," *The Institution of Mechanical Engineers, Proceedings of the International Conference on Gearing*, London, 23–25 September, 1958, Paper 29.
6. ISO/TS 6336-20 November, 2017.
7. Kelly, B.W. "A New Look at the Scoring Phenomena of Gears," *SAE Transactions*, Vol. 61, 1952, p. 175.
8. MAAG Gear Wheel Company Ltd, 1963, pages 128–130.
9. MAAG Gear Wheel Company LTD, 1983, pages 153–155, 166–168, January, 1990.
10. MRT Laboratories.
11. Streibek, R. 1901, "Ball Bearings for any Load (Ball Bearings for Any Stress)," *Journal of the Association of German Engineers* 45; 1902, "The Essential Features of the Plain Roller Bearings."
12. Wink, C.H. *Gear Technology*, pages c82, 86, April, 2012.
13. Wydler, R. "Calculation of Scoring Resistance in Gear Drives," Introduction, pages 4–6, Zurich, April, 1972, Springer Publishing.



**John B. Amendola** is Chief Executive Officer of Artec Machine Systems where he has been working for 48 years. Prior employment was with Western Gear, Texaco & Boeing Co. He is currently an active member of the AGMA Helical Gear Rating & Lubrication Committees, active chairman of AGMA Enclosed High-Speed Units Committee and active chairman of US TAG to ISO TC60. He holds a Bachelor in Mechanical Engineering from Villanova University and a Master of Science in Mechanical Engineering from (NYU) Brooklyn Polytechnic Institute.



**John B. Amendola III**, is the President of Artec Machine Systems where he has been working for 28 years. Prior experiences include: 1 year at Maag Gear, Zurich Switzerland, with assembly, testing, field services group for high speed gear applications; and 2 years at SUNY Maritime College, Assistant Professor Engineering Department training of engineering undergrads in Marine/Mechanical operations. He is an active member AGMA Helical Gear Rating Committee and holds a Bachelor of Science in Marine Engineering from Maine Maritime and a Professional Engineering License for Mechanical Engineering. John III also maintains a USCG unlimited license as a senior Marine Engineering Officer and Commander Retired US Navy Reserve.



**Robert Errichello, PE**, heads his own gear consulting firm—GEARTECH ([rlgears@mt.net](mailto:rlgears@mt.net))—and is a founder of GEARTECH Software, Inc. A graduate of the University of California at Berkeley, he holds B.S. and M.S. degrees in mechanical engineering and a master of engineering degree in structural dynamics. In his more than 30 years of industrial experience, Errichello worked for several gear companies; he has also been a consultant to the gear industry for more than 20 years and has taught courses in material science, fracture mechanics, vibration and machine design at San Francisco State University and the University of California at Berkeley. He is also a member of ASM International, STLE, ASME Power Transmission and Gearing Committee, AGMA Gear Rating Committee and the AGMA/AWEA Wind Turbine Committee. Errichello has published dozens of articles on design, analysis and the application of gears, and is the author of three widely used computer programs for the design and analysis of gears. He is also a longtime technical editor for *Gear Technology* magazine and *STLE Tribology Transactions*, and has presented numerous seminars on design, analysis, lubrication and failure analysis of gears. Errichello is a past recipient of the AGMA TDEC award and the STLE Wilbur Deutch Memorial award.



# Helios

## ANNOUNCES SERVICE ENGINEER

**Michael Weas** has filled a new position of applications engineer at Helios Gear Products. In this role, Weas supports gear manufacturers in several ways. For example, he serves as Helios's primary technical resource for cutting tools and their applications, which include hobs, shaper cutters, broaches, and milling cutters. Weas also designs and coordinates fixturing and automation solutions for Helios machines installed in North America.



"Mike's experience and mechanical engineering knowledge support Helios's gear manufacturing customers so they can focus on improving their business," said Adam Gimpert, Helios president. "Our customers are better equipped for the challenges of tomorrow because of Mike's hard work."

Weas is a degreed mechanical engineer from Northern Illinois University, where he learned strong fundamentals of mechanical thinking. While finishing his college work, he joined Helios part-time and began growing his expertise for the gear manufacturing industry. Since joining Helios full-time in 2018, Weas has taken on several duties as an applications engineer, and he always aims to equip manufacturers for more profitable production. For example, he has greatly improved Helios's offering of cutting tools by building a resource of built-to-order carbide hobs with delivery times as quick as 2 weeks while maintaining market-leading prices. Under his direction, Helios has doubled its cutting tool sales and continues to see significant growth in 2020. Similarly, Weas has strengthened Helios's fixturing solutions by offering updated designs, high quality manufacturing, more cost-effective solutions, and shorter deliveries. Consequently, manufacturers can be nimbler, save on costs, and continue to produce world-class gears on Helios equipment.

"Our customers are fortunate to have Mike's expertise at-hand. As Helios empowers gear manufacturers to be more competitive in the global marketplace, support for applications and engineering plays a critical role. Mike fills that role and more, and consequently, our customers are more productive," said David Harroun, Helios vice president. ([www.heliosgearproducts.com](http://www.heliosgearproducts.com))

# Index

## NAMES INIRAM PRECISION MACHINE TOOL AS NORTHEAST DISTRIBUTOR

Effective February 21, 2020, Index has named Iniram Precision Machine Tool as its distributor of record for Connecticut, Maine, Massachusetts, New Hampshire, Western Pennsylvania, Rhode Island, Vermont and West Virginia. The move reflects Index's ongoing strategy of partnering with distributors who can offer standard-setting service and support to help meet the needs of a rapidly expanding customer base.



**Jacob Marini, sales and operation intern, and Lucien Marini, founder and CEO, stand in front of an Index G200 turn-mill during a recent trip that Iniram made to Index's facilities in the Stuttgart region of Germany.**

"Index has achieved substantial sales growth over the past three years, and we are firmly committed to offering excellent support to our new customers," said Tom Clark, president and CEO of Index. "In addition to adding internal service and engineering staff to grow our North American team by over 70%, we are also ensuring that our network of distributors are able to offer local support to customers. Iniram has a strong presence in the Northeast, with technical personnel who can provide fast and high-quality service to manufacturers. We are pleased to establish this relationship with their team."

Iniram is headquartered in Middleton, Massachusetts, where it maintains a technical center to demonstrate machine technologies and host customer meetings. The company specializes in selling and supporting technically advanced European machine tools and machine tool automation and is completely dedicated to optimizing its customers' productivity and cost performance.

"When we look at the type of company we want to represent, we want to be sure they offer a level of technology that provides a tangible performance advantage," says Lucien Marini, founder and CEO of Iniram. "Index fits this bill with its portfolio of machines for completely machining parts in a single setup, as quickly as possible. We're excited to be able to offer their products to our customers." ([us.index-traub.com](http://us.index-traub.com))

# Bill Miller

SET TO RETIRE FROM KAPP NILES IN MAY 2020

Bill Miller, vice president sales at Kapp Technologies, will take his well-deserved retirement in May 2020. In November last year, he was honored by the management of the Kapp Niles group for his many years of loyalty and commitment. As a souvenir gift, he received a 3D printed model of the Coburg Veste and a collage of pictures with his colleagues.



Bill Miller (left) stands with Shane Hollingsworth (right).

As early as the 1980s, Miller, as service and sales manager at American Pfauter, had contact with products from the group of companies. After working for M&M Precision Systems and GearHelp LLC, he took over the position of vice president sales at Kapp Technologies in 2007. In the thirteen years under Miller, Kapp Niles has enjoyed significant growth and success in the American market. He has always passed on his enthusiasm for Kapp Niles products and his many years of experience to the next generations.

As his successor, Shane Hollingsworth will be responsible for managing sales for the North American market in the position of vice president sales. After successfully completing his bachelor's degree in mechanical engineering, Hollingsworth gained experience with transmission components at the gear supplier Fairfield (now Dana Lafayette). Since 2016 he has already been looking after customers of the division industry at Kapp Technologies and will now promote the overall sales in the function as vice president sales.

Adam Greener has already been recruited as reinforcement in the sales team in June 2019. As a long-standing salesman for filter systems at Hoffmann Filter Corporation and subsequent in the position as sales manager automotive at Filtra Systems, he was able to establish numerous contacts in the automotive industry. "Adam's experiences with major OEM's and proximity to them will help us further support our customers and grow our business," said Hollingsworth. ([www.kapp-niles.com](http://www.kapp-niles.com))



**NEW**  
Release  
2019

## KISSsoft Highlights

- Intuitive concept design on system level with KISSdesign
- Rolling bearing calculation with connection to SKF cloud
- Contact analysis (LTCA) of asymmetric gears
- Crossed helical gear with rack
- Feasibility assessment for „Power Skiving“

KISSsoft AG  
A Gleason Company  
T. +41 55 254 20 50  
info@KISSsoft.com

Free trial version at [www.KISSsoft.com](http://www.KISSsoft.com)

Drivetrain Design Solutions **KISSsoft**

# Spiral Bevel Gears

- Spiral & straight bevel gear manufacturing.
- Commercial to aircraft quality gearing.
- Spur, helical, splined shafts, internal & external, shaved & ground gears.
- Spiral bevel grinding.
- Midwest Transmissions & Reducers.
- ISO compliant.



Midwest Gear & Tool, Inc.  
15700 Common Rd., Roseville, MI 48066  
Tel: 586.779.1300 [mwgear@midwestgear.net](mailto:mwgear@midwestgear.net)



# ECM Technologies

## WELCOMES BILL GORNICKI AS DIRECTOR OF SALES

ECM Technologies recently announced the appointment of Bill Gornicki as director of sales at ECM USA, Inc. in Pleasant Prairie, WI. Previously of Diablo Furnaces, ALD Vacuum Systems and Ipsen, Gornicki joins the ECM USA team with 30 years of heat treat industry experience. Gornicki's experience and focus in low pressure vacuum carburizing will further company equipment sales with project forecasting, development and management, and bring a dynamic twist in market analysis, technical papers and advertising for the USA and Canada markets.



Bill Gornicki (left), Dennis Beauchesne (right).

"We are very excited to have Bill join the ECM Group! His experience, knowledge and heat treat industry background will be a valuable asset to our team," states Dennis Beauchesne, ECM USA general manager.

Gornicki is an accomplished sales professional with extensive knowledge in the LPC market. He was previously on the board of directors with AGMA (American Gear Manufacturers Association), was a member of the board of directors for CHTE (Center for Heat Treat Excellence at Worcester Polytech) and is a member of ASM (Advanced Society of Materials).

([www.ecm-usa.com](http://www.ecm-usa.com))

# Buehler

## CELEBRATES WILSON HARDNESS 100-YEAR ANNIVERSARY

Buehler, an ITW Company, celebrates the 100-year anniversary of its Wilson hardness brand which was originally known as the Wilson Mechanical Instrument Company. Here Stanley Rockwell and founder Charles H. Wilson introduced the Rockwell hardness tester, an industry standard. Later, Wilson became the home of the legendary Tukon line of micro-indentation testers — renowned for Knoop and Vickers testing. These early inventions revolutionized industry and paved the way for Wilson today, with innovations that improve usability and allow for full connectivity and automation like the *DiaMet* software and the powerful and versatile Universal hardness tester.



Buehler is proud to commemorate and celebrate the legacy of the Wilson name. Buehler's affiliation with Wilson began in 2012 when the Wilson brand of hardness testers encompassing Reicherter, Wilson, and Wolpert products became part of Buehler's offering.

According to Buehler General Manager, Julien Noel, "We are proud to continue the 100-year legacy of innovation and excellence in Wilson Hardness. By having our engineering, manufacturing, and service in-house, Buehler's Wilson products have become the preferred choice for demanding labs that need to consistently meet quality standards. In the coming year, Buehler will continue to focus on exceeding customer expectations with a new and improved Rockwell tester, and an extended range of hardness reference blocks according to ISO, ASTM and JIS standards." ([www.buehler.com](http://www.buehler.com))

# MC Machinery Systems

## ANNOUNCES PERSONNEL ADDITIONS

MC Machinery Systems is excited to welcome **Craig Barbeck** to the MC Machinery team as a regional sales representative for the Northern Ohio Territory. Barbeck will support the sales team with a focus on laser and press brake products.

Barbeck's strong technical and engineering background provides him with a unique insight into the needs of MC Machinery customers.

With over 15-years of experience in the fabrication industry and machine tool sales, Barbeck will utilize his industry expertise to increase sales support and boost customer satisfaction.

Barbeck previously served customers in Eastern Ohio, Pennsylvania, Upstate New York, Maryland, and Texas. He currently resides in the Greater Cleveland Area.

"I'm honored to accept a position alongside the well-respected MC Machinery team," Barbeck said. "I look forward to upholding MC Machinery's long-standing success by expanding our customer base in Northern Ohio," Barbeck said.



**Mark Kauffman** has joined the team as a regional sales representative for Southern California, Nevada, and New Mexico. Kauffman will utilize his industry expertise to increase product sales and customer satisfaction.



With over 30 years of experience in the metal fabrication industry, Kauffman is an accomplished member of the industry in many aspects.

His experience includes engineering, quality control, production and facility management, manufacturing, and sales.

“I am excited to work alongside the MC Machinery team,” Kaufmann said. “I look forward to developing and providing customer-based solutions.”

**Shannon Morris** was recently named regional sales representative for North/Central Texas and a portion of East Texas. Morris will utilize her extensive industry knowledge to support local customers and grow MC Machinery product sales.



Having 28 years of outside sales experience, Morris has acquired a comprehensive background in sales and account management. Her most recent position was with an industrial gas and welding supplies distributor as an outside sales representative in the Dallas-Fort Worth Metroplex / Oklahoma Territory.

“I’m thrilled about the opportunity to increase MC Machinery’s visibility in the manufacturing industry,” Morris said. “I look forward to expanding our loyal customer base.”

([www.mcmachinery.com](http://www.mcmachinery.com))

## Mazak

### HOSTS CONGRESSMAN AND NASA ADMINISTRATOR AT MANUFACTURING CAMPUS

Mazak Corporation recently hosted NASA’s new administrator James Frederick “Jim” Bridenstine and Rep. Thomas Massie of Kentucky at its Florence, Kentucky, North American Manufacturing Headquarters. The administrator and congressman made a special trip to Mazak after attending a high-level round-table event with Mazak President Dan Janka, representatives of local aerospace manufacturers and educational leaders as well as three Ohio state congressmen and other area politicians. The event highlighted the large number of aeronautical-based companies that operate within the Greater Cincinnati/Northern Kentucky region and rely on suppliers such as Mazak for new and innovative manufacturing technology.

([www.mazakusa.com](http://www.mazakusa.com))

PUTTING  
A LIFETIME

OF

GEAR  
DESIGN

EXPERIENCE

TO WORK FOR YOU

- Reverse engineering
- Gearbox upgrades
- Custom gearbox design
- Specification development
- Project management
- Vendor qualification
- Design reviews
- Bid evaluations
- Tooling design
- Customized gear training
- Equipment evaluation
- Custom machine design

**Charles D. Schultz**  
**chuck@beytagear.com**  
**[630] 209-1652**

[www.beytagear.com](http://www.beytagear.com)

COMPACT. CONSISTENT. COMPETITIVE.

[kapp-niles.com](http://kapp-niles.com)



**KAPP NILES**

precision for motion

- 2 Channel Transmission — Page 33**  
*2channeltransmission.com*
- B&R Machine and Gear Corp. — Page 21**  
*www.brgear.com*
- Beyta Gear Service — Page 61**  
*www.beytagear.com*
- Bourn & Koch — Page 7**  
*www.bourn-koch.com*
- Cattini North America — Page 33**  
*www.cattiniNA.com*
- Circle Gear — Page 32**  
*www.circlegear.com*
- Dillon Manufacturing — Page 31**  
*dillonmfg.com*
- DTR Corp. — Page 19**  
*www.dragon.co.kr*
- DVS Group — Page 3**  
*www.dvs-technology.com*
- Forest City Gear — Page 11**  
*www.forestcitygear.com*
- Gear Research Institute — Page 33**  
*gearresearch.org*
- Gleason Corporation — Pages 15, 59**  
*www.gleason.com*
- Hainbuch America — Inside Back Cover**  
*www.hainbuchamerica.com*
- Helios Gear Products — Page 4**  
*heliosgearproducts.com*
- Hobsource Inc. — Page 33**  
*www.hobsource.com*
- Hy-Tech Engineered Solutions — Page 27**  
*www.ptggears.com*
- IMTS — Page 43**  
*hybrid.IMTS.com*
- Index Technologies Inc. — Page 34**  
*www.indextechnologiesinc.com*
- ITW Heartland — Page 27**  
*spiroidgearing.com*
- Kapp-Niles — Page 61**  
*kapp-niles.com*
- KissSoft — Page 59**  
*www.kisssoft.com*
- Klingelberg — Outside Back Cover**  
*www.klingelberg.com*
- Liebherr — Page 5**  
*www.liebherr.com*
- Lubriplate — Page 13**  
*www.lubriplate.com*
- Machine Tool Builders — Page 23**  
*Machinetoolbuilders.com*
- McInnes Rolled Rings — Page 17**  
*www.mcinnesrolledrings.com*
- Midwest Gear & Tool — Page 59**  
*mwgear@midwestgear.net*
- Mitsubishi Heavy Industries America — Page 8**  
*www.mitsubishigearcenter.com*
- Nachi — Page 16**  
*www.nachiamerica.com*
- Nordex Inc. — Page 35**  
*www.nordex.com*
- Oelheld US Inc. — Page 31**  
*www.oelheld.com*
- Orca Machine Tools — Page 32**  
*www.orca-inc.com*
- Orris Drive — Page 35**  
*b2b.worldtrade.org.tw/16697150*
- Penta Gear Metrology — Pages 22, 32**  
*www.gearinspection.com*
- Proto Manufacturing — Page 31**  
*www.protoxrd.com*
- SMT — Page 29**  
*www.smartmt.com*
- Star SU LLC — IFC-Page 1, Page 33**  
*www.star-su.com*
- United Tool Supply — Page 35**  
*unite-a-matic.com*



## RESPONSE REQUIRED

**YES** I want to receive/continue to receive *Gear Technology*

**NO** Thanks anyway, but I don't need the world's best publication on gear engineering and manufacturing.

Name \_\_\_\_\_ Job Title \_\_\_\_\_  
(please print)

Signature \_\_\_\_\_ Date \_\_\_\_\_  
(required)

### How would you like to receive *Gear Technology*?

- PRINT version (Verify mailing info below)
- DIGITAL Version (E-mail required)
- BOTH Print AND Digital (E-mail required)

E-mail \_\_\_\_\_ \*

### How are you involved with GEARS?

- My company MAKES GEARS (20)
- My company BUYS GEARS (22)
- I DESIGN gears (23)
- I am a SUPPLIER to the GEAR INDUSTRY (24)
- OTHER (Please describe) \_\_\_\_\_

What is your company's principal product or service? \_\_\_\_\_  
\_\_\_\_\_

**\*Your PRIVACY is important to us. You get to CHOOSE how we use your personal information. The next e-mail we send you will have clear instructions.**

### MAILING INFORMATION

NAME:

JOB TITLE:

COMPANY:

ADDRESS:

- Check if this is a home address

CITY:

STATE/Province:

ZIP/Postal Code:

PHONE:

FAX:

**Put your business card here to make it easier!**



Mail to:  
1840 Jarvis Ave., Elk Grove Village, IL 60007 USA

or

FAX to 1-847-437-6618  
SCAN to: [subscribe@geartechnology.com](mailto:subscribe@geartechnology.com)

# Using Gears to Pour a Beer

Joseph L. Hazelton, Contributing Editor

## “Fascinating, fun, and functional.”

That’s how Clayton Boyer describes the gears in the Brew Tipper, his wooden mechanism that pours a bottle of beer into a glass. He adds: “I love creating geared mechanisms and gadgets.”

Now, as a mechanism, the Brew Tipper’s operation is straightforward. You put a bottle of beer on a small platform on the left, you put a glass on a small platform on the right. Then, you turn a wheel at the front of the tipper. The wheel is connected to a rod that runs to the back of the tipper. The rod is connected to one of the tipper’s spur gears, the smaller gear. That gear drives the larger one. The larger gear itself is connected to a cam. The two gears lift and tip the beer bottle forward, while the cam tips the glass backward.

With both glass and bottle tipped, beer doesn’t splash in the bottom of the glass. Instead, it runs down the inside of the glass, so it doesn’t get too foamy. And if it does start getting too foamy, the tipper has a ratchet and pawl that can stop and hold the tipper in mid-pour.

For the tipper to work, though, the top of the beer bottle and the top of the glass need to be level with each other. So, Clayton designed his tipper to include several inserts. Each one fits in the bottom of the tipper’s bottle holder (the platform on the left). This way, a shorter bottle can be raised until the top of it lines up with the top of the glass.

However, the tipper pours beer slowly. The reason: leftover ingredients in home-brewed beer.

Naturally, the tipper can pour bottles of commercial beer or home-brewed beer. However, to pour home-brewed, the tipper has to pour slowly.

Clayton, a home brewer himself, explains. Commercial beer is usually filtered before it’s bottled. The filtering removes ingredients that weren’t fully absorbed when the beer was being made. Home-brewed beer, though, may not be filtered. A bottle of home brew, then, would include a small amount of leftover ingredients, which would sink to the bottom. So, when poured, a home brew would need to be poured slowly so the leftover ingredients stay in the bottom of the bottle, they don’t get carried into the glass.

Besides designing it for home-brewed beer, Clayton also designed the tipper with an amount of flexibility. He designed it so a person could alter that design and build the tipper to pour beer bottles bigger than a longneck, bottles like a Belgian or a bomber. Specifically, he provided clearance so a person could build a larger version of the bottle holder.

Clayton took about four months to design and build the tipper. However, he comments that it takes just a few days to build one from its finished plans. After building the tipper, Clayton digitized his plans and uploaded them to lisaboyer.com, the website he and his wife share. To see the tipper in action, there’s a video on [quilty1987](#), the YouTube channel Clayton and his wife also share. The channel includes videos on many of Clayton’s geared mechanisms.

As for his interest in geared objects, Clayton explains it started when he was a 10-year-old kid looking at how-to magazines like *Popular Mechanics*.

One day, he noticed an article about building a wooden clock. Clayton was interested, but had no money for tools or materials. “Pretty much all I could do was dream about building a wooden clock,” he comments.

In time, his dream receded in his mind. Decades later, though, as a retiree, Clayton was looking through a woodworking magazine when he noticed a picture. In it, a wooden clock was hanging on a wall.

Clayton’s dream returned, and it sparked more than the building of one wooden clock. ⚙️



The Brew Tipper’s gears and cam work together to tilt a beer bottle forward and tilt a glass backward so beer runs down the inside of the glass, which keeps the beer from getting too foamy. (Photo courtesy of Clayton Boyer)



# MANDO G211

Segmented mandrel for gear cutting

- Segmented mandrel with slim interference contour
- Rigid radial clamping with pull-back effect
- Large clamping range and vibration dampening due to vulcanized clamping bushings
- In-stock standard segmented clamping bushings
- Three end-stop levels
- Integrated flushing channels

1.800.281.5734  
Germantown, WI USA  
[www.hainbuchamerica.com](http://www.hainbuchamerica.com)

 **America**  
**HAINBUCH**  
WORKHOLDING TECHNOLOGY

# LEADING EFFICIENCY WITH FLEXIBLE MACHINING AND REDUCED GRINDING TIMES



More information:



Cylindrical gear manufacturers worldwide appreciate the benefits and high productivity of the profile grinding machines of the HÖFLER RAPID series. They offer a perfect set-up with standard features including a cast polymer machine bed, torque motor-driven machine table, integrated inspection system, sturdy grinding spindle, and a dressing system for frequent profile modifications. The RAPID series can be individually configured for workpiece diameters from 20 to 8,000 mm and retooling from external to internal gears takes virtually no time. In addition, technologies such as high-speed grinding or best-fit grinding reduce machining times by up to 30 %. A winning combination that gives you a clear lead in machining efficiency for the entire manufacturing process.

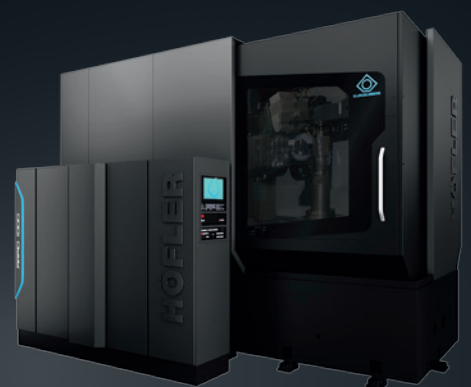

BEVEL GEAR TECHNOLOGY | CYLINDRICAL GEAR TECHNOLOGY | PRECISION MEASURING CENTERS | DRIVE TECHNOLOGY

[WWW.KLINGELBERG.COM](http://WWW.KLINGELBERG.COM)