

# GEAR TECHNOLOGY

THE JOURNAL OF GEAR MANUFACTURING

MARCH / APRIL 1993



## SPECIAL FOCUS ON HEAT TREATING

CONTROLLING THE CARBURIZING PROCESS FOR TOP QUALITY GEARS

DUAL FREQUENCY INDUCTION HARDENING

FROZEN GEARS

SURFACE MEASUREMENT TECHNOLOGY

INTRODUCTION TO WORM GEARS

EXPORTING - GETTING STARTED

# American Pfauter's New CNC Gear Shapers...

*Because yesterday's technology simply can't cut it!*

New Pfauter 3-, 4- and 5-axis CNC gear shaping machines put greatly improved performance in a compact, self-contained and economical package...the perfect fit for today's gear manufacturing operations.

*Consider these outstanding features:*

- ☑ GE FANUC CNC controls and digital servo drive systems, completely eliminating change gears
- ☑ Small-footprint design:  
Only 4.8 sq. meters of floor space required
- ☑ Five machine sizes and configurations to choose from:  
3-, 4- and 5-axis models; up to 20" pitch diameter; models available with CNC controlled cutter slide
- ☑ Quick change tooling
- ☑ High continuous stroking rates, with hydrostatic guide and spindle bushing design
- ☑ All maintenance points accessible without interference

*All told, you get:*

- ☑ High machine efficiency and utilization rates
- ☑ Vast improvements in throughput
- ☑ Greatly increased cutter life    ☑ Superior gear quality, surface finishes    ☑ Fast ROI

Then factor in American Pfauter's unsurpassed support capability...design teams...application expertise...the industry's most advanced and productive shaper cutters...all available from a single-source conveniently located in Rockford, Illinois.

*But why not see for yourself?*

Call (815) 282-3000 for more information or to schedule a visit to our facility.



**AMERICAN PFAUTER**  
Limited Partnership

1351 Windsor Road  
Loves Park, IL 61132-2698 U.S.A.

Phone: 815-282-3000  
Telefax: 815-282-3075

CIRCLE A-1 on READER REPLY CARD

# Guess who's the fastest-growing producer of Shaper Cutters?



*More customers around the world are turning to PMCT to meet their most demanding Shaper Cutter needs. Here's why:*

*We're innovators.* PMCT hasn't stood pat on conventional shaper cutter technology. New approaches, designs, and materials are in constant development. And our unique Isoform grinding process gives our shaper cutters the longest effective tool length available. Our cutters

average 25% lower cost per thousandth of usable tool life as a result.

*First in customer support.* PMCT is rated No. 1 in 'customer support' by leading automotive, trucking, and other industry OEMs. They've found that only PMCT has the design teams, applications expertise, and modern manufacturing technology to ensure on-time delivery of a qualified product. Product quality is assured throughout manufacturing with SPC, and advanced inspection equipment.

*Here to stay.* PMCT is in for the long

haul. Just look at the investment we've made in modern facilities, new equipment, and people—all committed to producing the best gear tools in the world. But don't take our word for it. Just call (815) 877-8900 and ask for the sales and service support team in your area.

Then put us to work!



**FREE**  
Circle Reader  
Service Card  
Number

## **Pfauter-Maag Cutting Tools**

Limited Partnership

1351 Windsor Road, P.O. Box 2950, Loves Park, IL 61132-2950 USA

Telephone 815-877-8900 • FAX 815-877-0264

CIRCLE A-2 on READER REPLY CARD

# CUT YOUR TIME LOSSES...

...with FHUSA, you know exactly what your hobs will do!

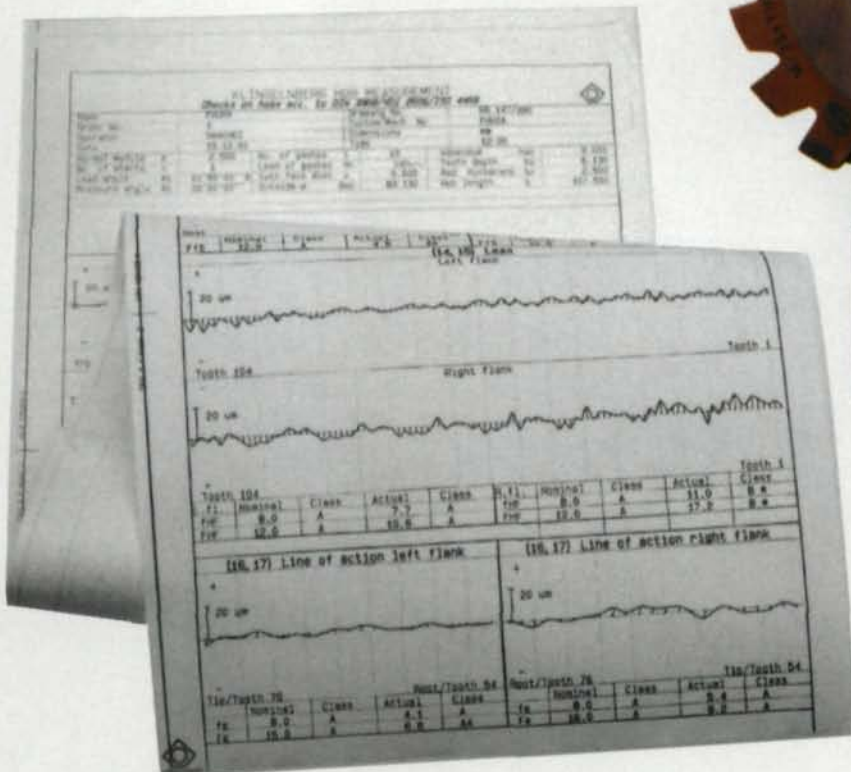

FHUSA takes the question out of gear hobbing with hobs that are tested and certified—before they leave our plant. We will even FAX our state-of-the-art hob test results. . .before we ship. It is your assurance that each FHUSA hob you receive will deliver the extremely critical tolerances you expect—not only as received new, but after each sharpening to the last usable edge of cutting life.

If you need consistent conformance to A or AA standards, specify FHUSA. . .the hob that delivers top quality by all standards. . .AGMA, DIN, ISO, etc.

For further information, FAX us. We will return FAX a typical hob report for your review. GMI, P.O. Box 31038, Independence, OH 44131. Phone (216) 642-0230. FAX (216) 642-0231.

# GMI



# CONTENTS

MARCH/APRIL 1993

## FEATURES

### Controlling the Carburizing Process for Top Quality Gears

*Roy F. Kern*

Kern Engineering Co., Peoria, IL..... 16

### Dual Frequency Induction Gear Hardening

*John M. Storm & Michael R. Chaplin*

Contour Hardening, Inc., Indianapolis, IN..... 22

### Frozen Gears

*Pete Paulin*

300° Below, Inc., Decatur, IL..... 26

### Improving Gear Manufacturing Quality With Surface Measurement Technology

*Mike Moyer*

Rank, Taylor, Hobson, Inc., Des Plaines, IL..... 30

## SPECIAL FEATURES

### Gear Fundamentals Introduction to Worm Gears

*James K. Simonelli*

JKS & Associates, Brecksville, OH..... 34

## DEPARTMENTS

### Publisher's Page

Little Things Mean A Lot..... 7

### Advertiser Index

Find the products and services you need..... 9

### Shop Floor

#### Gear Material Quality: How To Judge It— Pitting: How To Prevent It

*Don McVittie,*

Gear Engineers, Inc., Seattle, WA..... 11

### Management Matters: Getting Started In Exporting

*Nancy Bartels*

Interview with Rick Norment of Norment & Associates.  
First in a 4-part series on exporting..... 41

### Classifieds

Products, services, and information you can use..... 46

### Calendar

Events of interest..... 48

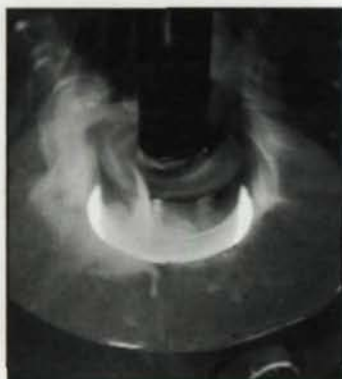

Cover photo courtesy of Fluxtrol Manufacturing, Troy, MI.

**HIGH NOON**



**BOUGHT & SOLD**

**FINE COWBOY ARTIFACTS**

bridles ★ buckles ★ horsehair  
bits ★ books ★ belts ★ bolos  
chaps ★ spurs ★ saddles

**APPRAISALS**

9929 Venice Blvd.  
Los Angeles, CA 90034

**(310) 202-9010 BY APPOINTMENT**  
**FAX (310) 202-8340**

★ western collectables ★

CIRCLE A-4 on READER REPLY CARD

**New!**

# 5-AXIS CNC HYPOID TOOL SHARPENER

Sharpens both bodies with integral blades  
and stick blades

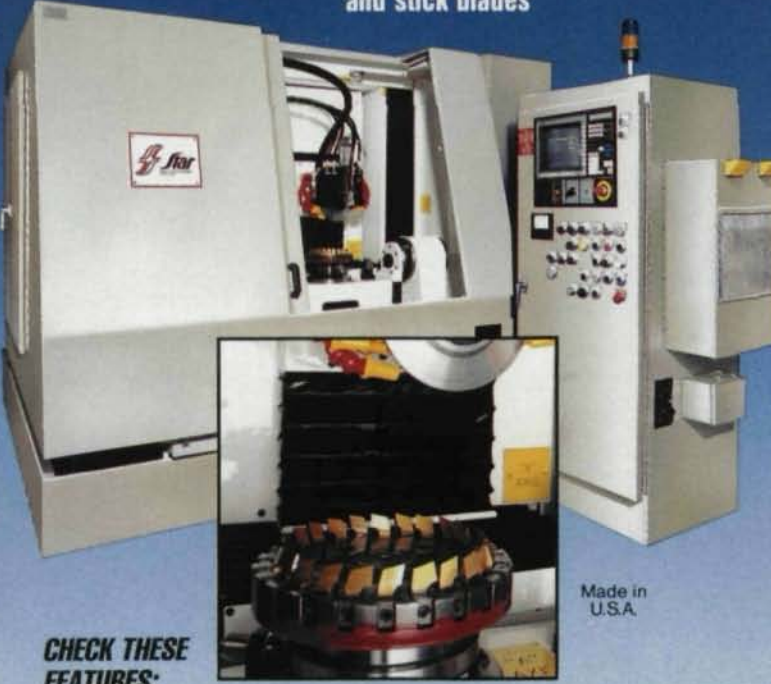

Made in U.S.A.

**CHECK THESE FEATURES:**

- ✓ **Accuracy** - All grinding operations completed in a single step.
- ✓ **Rapid Setup or Changeover** - Bodies to blades, roughing to finishing, other diameters.
- ✓ **Full Probing Capabilities** - For both part and wheel location.
- ✓ **CBN Wheel** - For better surface integrity and finish, longer tool life.

**These features result in unprecedented productivity.**  
CONTACT US FOR FULL DETAILS.



**ELK RAPIDS ENGINEERING**  
Subsidiary of Star Cutter Company  
210 Industrial Park Drive • P.O. Box 728 • Elk Rapids, MI 49629  
Phone 616/264-5661 • Fax 616/264-5663

CIRCLE A-5 on READER REPLY CARD

## GEAR TECHNOLOGY

### EDITORIAL

Publisher & Editor-in-Chief  
**Michael Goldstein**

Associate Publisher & Managing Editor  
**Peg Short**

Senior Editor **Nancy Bartels**

Technical Editors  
**Robert Errichello**  
**William L. Janninck**  
**Don McVittie**  
**Robert E. Smith**

### ART

Art Director **Jean Sykes**

Art Director **Jennifer Goland**

### MARKETING

Advertising Sales Manager **Patricia Flam**

Sales Coordinator **Donna-Marie Weir**

### CIRCULATION

Administrative Coordinator  
**Deborah Donigian**

Circulation Assistant  
**Janice Jackson**

### RANDALL PUBLISHING STAFF

President **Michael Goldstein**

Vice President **Richard Goldstein**

Vice President/General Manager **Peg Short**

Controller **Patrick Nash**

Accounting **Laura Kinnane**

Art Consultant **Marsha Goldstein**

### RANDALL PUBLISHING, INC.

1425 Lunt Avenue  
P.O. Box 1426  
Elk Grove Village, IL 60007  
(708) 437-6604 Phone  
(708) 437-6618 Fax

### VOL. 10, NO. 2

**GEAR TECHNOLOGY**, The Journal of Gear Manufacturing (ISSN 0743-6858) is published bimonthly by Randall Publishing, Inc., 1425 Lunt Avenue, P.O. Box 1426, Elk Grove Village, IL 60007. Subscription rates are: \$40.00 in the U.S.; \$50.00 in Canada; \$55.00 in all other countries. Second-Class postage paid at Arlington Heights, IL, and at additional mailing offices.

Randall Publishing makes every effort to ensure that the processes described in *Gear Technology* conform to sound engineering practice. The Publisher cannot be held responsible or liable for injuries sustained or any direct or indirect, special, consequential, or other damages of any kind or nature whatsoever resulting from following the procedures described.

Randall Publishing is not responsible for the content of, claims made, or opinions expressed in advertisements or other printed matter in the publication.

Postmaster: Send address changes to **GEAR TECHNOLOGY**, The Journal of Gear Manufacturing, 1425 Lunt Avenue, P.O. Box 1426, Elk Grove Village, IL, 60007.

©Contents copyrighted by RANDALL PUBLISHING, INC., 1993. Articles appearing in **GEAR TECHNOLOGY** may not be reproduced in whole or in part without the express permission of the publisher or the author.

# GMI-KANZAKI

FOUR  
DOES IT  
TIMES  
BETTER  
Better

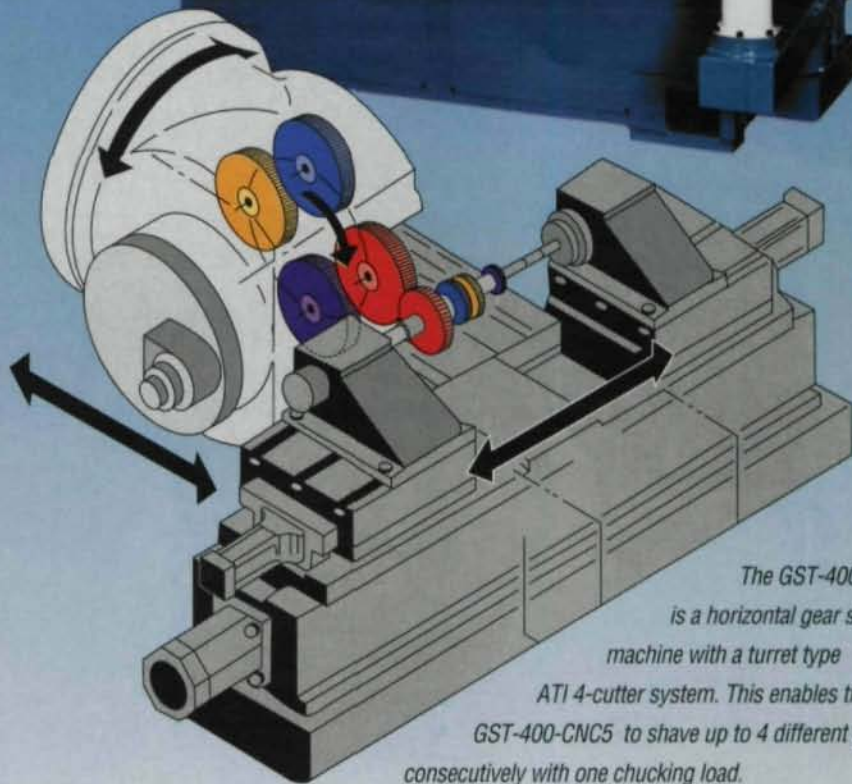

The GST-400-CNC5 is a horizontal gear shaving machine with a turret type ATI 4-cutter system. This enables the GST-400-CNC5 to shave up to 4 different gears consecutively with one chucking load.

**T**he concentricity of these four gears in relation to each other is unmatched since the operation is completed on a CNC Machine, consecutively, with the same set up. Everyone else has to run each gear through as individual, expensive shaving operations, handling the parts as many as four times.

**Why? Because GMI-Kanzaki World Class CNC Shaving Machines feature a turret type cutter system to shave as many as 4 cluster gears consecutively.**

GMI-Kanzaki does it better with heavy duty construction for increased stability and rigidity. You'll appreciate the resulting increases in tool life and superior surface finish.

Overall, the outstanding increase in quality as a result of consecutive operations and heavy duty construction will have a dramatic impact on profitability. It all adds up to a greatly improved bottom line.

***GMI-Kanzaki gives you the edge to emerge as a major player in a world economy.***

GMI-Kanzaki  
6708 Ivandale Rd.  
P.O. Box 31038  
Independence, OH 44131  
Phone (216) 642-0230 FAX (216) 642-0231  
CIRCLE A-14 on READER REPLY CARD

# **GMI-KANZAKI**

# This is how America gears up for quality

Most of the universal CNC gear inspection systems sold in the U.S. come from M&M Precision Systems. More than all our competitors combined.

Why?

Because M&M systems give you the strongest competitive advantage.

How?

Consider these three examples:

## Easier inspection

Once your part is on an M&M machine, the computer screen prompts you to enter specifications. Then you tell it what features you want to analyze, and the machine inspects the part. The next time, all you do is enter the part number. It's that easy.



## More capability

You get true (not just theoretical) index, lead and involute testing using interactive Generative Metrology techniques. The inspection of blanks and cutting tools as well as gears. SPC and cutting tool software. And the ability to inspect gear surface finish, spiral bevel and hypoid gears, worms, involute scrolls, and male/female helical rotor vanes.

## Better technical support and service

You'll get a choice of standard or custom engineered packages with specific application software. And M&M programs are always written in English to avoid problems with translations or cultural differences. So you'll avoid clashes between your American results approach and other countries' process approach.

Get all the fast, free facts in the 12-page *M&M QC Gear Analyzers* brochure. Circle the number below. Call 513/859-8273. Or Fax 513/859-4452 today.

And put your quality in gear.

 **M&M PRECISION SYSTEMS**

AN ACME-CLEVELAND COMPANY  
CIRCLE A-10 on READER REPLY CARD





# Little Things Mean A Lot

*"God is in the details,"* says the philosopher. What he meant was that on the scale of the universe, it's not just the galaxies, the planets, the mountain ranges, or the major rivers that are important. So are the subatomic particles and the genes. It's the little things that make all the difference.

That's true on other scales as well. It's certainly true in magazine production, and, I believe, it's equally true in gear manufacturing. The small stuff does matter. It's not enough to have a good design. The right materials are important as well. So is the proper handling of those materials.

Even a good product alone is not enough to make a successful business. The financial planning, the labor/management relations, the advertising and marketing, all need to be carefully managed to make any business successful.

In this issue of *Gear Technology* we are focusing on some of the "little things" that are important to your gear business. Heat treating, for example, is not the whole story in gear manufacturing, but failure in this small area can mean all your hard work and careful planning in design and production will come to naught. In heat treating, it's what you don't see, what happens beneath the surface on the molecular level, that makes the difference between a good and a bad gear. Therefore, we have included three articles

*"...No circumstance, however trifling, is too minute..."*

*-Oliver Goldsmith*

on heat treating, covering some of the basics as well as new technologies, to help you look more closely at this important detail of the gear manufacturing process.

Gear testing is also not the whole story on gear quality, but it too is an important detail, so we have included an article on advances in surface measurement technology. Again, in gear testing, accuracy in terms of millimeters can

make all the difference.

Likewise, while not every reader will have occasion to use the technology discussed in our Gear Fundamentals feature, "Introduction to Worm Gearing," as the author points out, careful attention to detail can make this "old fashioned" gear system just the right one for particular applications.

Not all the details that need attention relate to what happens in the design offices or on the shop floor. In today's economy, what happens across the globe may have as much impact on your business as what happens in your plant. For companies thinking of becoming part of this global market, we have included the first article in a series on exporting. This story covers the basics of getting started: what do you need to do, know, and think about - the details to be considered before making this important business move.

The little things do matter, whether in philosophy, science, or gear manufacturing. While it's true that one can run the risk of missing the forest because of the trees, one can also forget that without the twigs, leaves, roots and subsoil, there's no forest at all.

## PUBLISHER'S PAGE

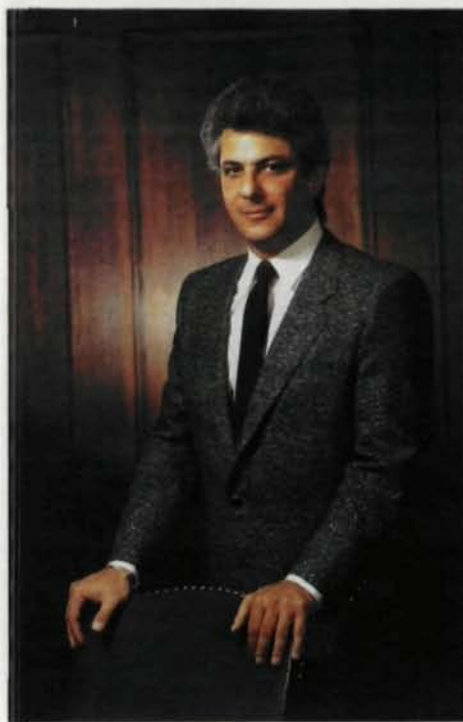

*Michael Goldstein*

Michael Goldstein  
Publisher/Editor-in-Chief

# GO AHEAD

**MAKE OUR DAY**  
**ANSWER SOME MORE**  
**NEW & EXCITING**  
**QUESTIONS**

## TELL US WHAT YOU REALLY THINK.

Tell us what you liked - and what you didn't - about this issue of GEAR TECHNOLOGY. We love the compliments, and we can take the criticism. Knowing how you feel about what we do will help us make GEAR TECHNOLOGY the best it can be. Please take a few minutes to fill out the attached form and fax it to us at (708) 437-6618.

My name is \_\_\_\_\_ My company is \_\_\_\_\_

### TELL US HOW YOU READ AND USE GEAR TECHNOLOGY.

1. In the last 12 months, which of the following actions have you taken as a result of reading an *article or column* in *Gear Technology*. (Please check all that apply.)  
 routed item to others     discussed item with others     copied/reprinted item for others     filed item for future reference  
 sought further information (from magazine, author, etc.)     no action take     other action: \_\_\_\_\_

2. In the last 12 months, which of the following actions have you taken as a result of seeing *advertisements* in *Gear Technology*?  
 discussed ad with others     passed ad along to others     filed ad for future reference  
 contacted manufacturer/supplier for more information     wrote advertiser directly     phoned advertiser directly  
 placed order for advertised product     other action: \_\_\_\_\_     no action taken

3. Which of the following industry-related publications do you personally *receive* under your own name? (Check all that apply.)  
 GEAR TECHNOLOGY     American Machinist     Machine Design     Power & Transmission Design  
 Cutting Tool Engineering     Others (Please list.) \_\_\_\_\_

4. Which do you read regularly, that is, at least 3 of 4 issues? (Check all that apply.)  
 GEAR TECHNOLOGY     American Machinist     Machine Design     Power & Transmission Design  
 Cutting Tool Engineering     Others (Please list.) \_\_\_\_\_

5. Which one publication, including GEAR TECHNOLOGY, do you find *most useful* in your work? (Please check only one.)  
 GEAR TECHNOLOGY     American Machinist     Machine Design     Power & Transmission Design  
 Cutting Tool Engineering     Others (Please list.) \_\_\_\_\_

### ABOUT GEAR TECHNOLOGY...PLEASE RATE THIS ISSUE. CHECK THE BOX THAT APPLIES.

FEATURES:	EXCELLENT	GOOD	AVERAGE	POOR	HAVEN'T READ
Controlling the Carburizing Process in Gears	<input type="checkbox"/>	<input type="checkbox"/>	<input type="checkbox"/>	<input type="checkbox"/>	<input type="checkbox"/>
Dual Frequency Induction Gear Hardening	<input type="checkbox"/>	<input type="checkbox"/>	<input type="checkbox"/>	<input type="checkbox"/>	<input type="checkbox"/>
Frozen Gears	<input type="checkbox"/>	<input type="checkbox"/>	<input type="checkbox"/>	<input type="checkbox"/>	<input type="checkbox"/>
Improving Gear Quality With Surface Texture Measurement	<input type="checkbox"/>	<input type="checkbox"/>	<input type="checkbox"/>	<input type="checkbox"/>	<input type="checkbox"/>
Gear Fundamentals	<input type="checkbox"/>	<input type="checkbox"/>	<input type="checkbox"/>	<input type="checkbox"/>	<input type="checkbox"/>
Introduction to Worm Gears	<input type="checkbox"/>	<input type="checkbox"/>	<input type="checkbox"/>	<input type="checkbox"/>	<input type="checkbox"/>
<b>REGULAR COLUMNS:</b>					
Shop Floor	<input type="checkbox"/>	<input type="checkbox"/>	<input type="checkbox"/>	<input type="checkbox"/>	<input type="checkbox"/>
Calendar	<input type="checkbox"/>	<input type="checkbox"/>	<input type="checkbox"/>	<input type="checkbox"/>	<input type="checkbox"/>
Management Matters	<input type="checkbox"/>	<input type="checkbox"/>	<input type="checkbox"/>	<input type="checkbox"/>	<input type="checkbox"/>
Ad Index	<input type="checkbox"/>	<input type="checkbox"/>	<input type="checkbox"/>	<input type="checkbox"/>	<input type="checkbox"/>
Publisher's Page	<input type="checkbox"/>	<input type="checkbox"/>	<input type="checkbox"/>	<input type="checkbox"/>	<input type="checkbox"/>

PLEASE FAX THIS FORM TO US AT (708) 437-6618 OR MAIL IT TO P. O. BOX 1426, ELK GROVE VILLAGE, ILLINOIS, U.S.A. 60009.

**THANKS FOR YOUR HELP.**

"The World of Gearing"

The only trade show devoted  
solely to the gearing industry

# GEAR EXPO '93

October 10 - 13  
Detroit, Michigan



For additional information:  
American Gear Manufacturers Association  
1500 King Street, Suite 201  
Alexandria, VA 22314  
Phone: 703-684-0211 Fax: 703-684-0242

CIRCLE A-15 on READER REPLY CARD

## ADVERTISER'S INDEX

	Reader Service No.	Page Number
Ajax Magnethermic Corp.	21	IBC
American Gear Manufacturers Association	15	9
American Pfauter, L.P.	1	IFC
American Metal Treating Co.	24	46
Bourn & Koch Machine Tool	13	14
Cincinnati Steel Treating Company	23	46
Diseng	16	43
Fairlane Gear, Inc.	18	45
GMI Fhusa	7	2
GMI Kanzaki	14	5
Guehring Automation Inc.	8	33
High Noon	4	4
ITW Heartland	26	46
James Engineering	9	33
Koepfer America	20	48
M & M Precision	10	6
Mack Truck	25	46
Manufactured Gear & Gage, Inc.	29	47
Normac, Inc.	41	10
Pfauter-Maag Cutting Tools, L.P.	2	1
Pro-Gear Co., Inc.	27	46
Profile Engineering, Inc.	28	46
Roto Technology, Inc.	11	13
Russell, Holbrook & Henderson, Inc.	12	13
Starcut Sales, Inc.	5	4
Tocco, Inc.	3	OBC

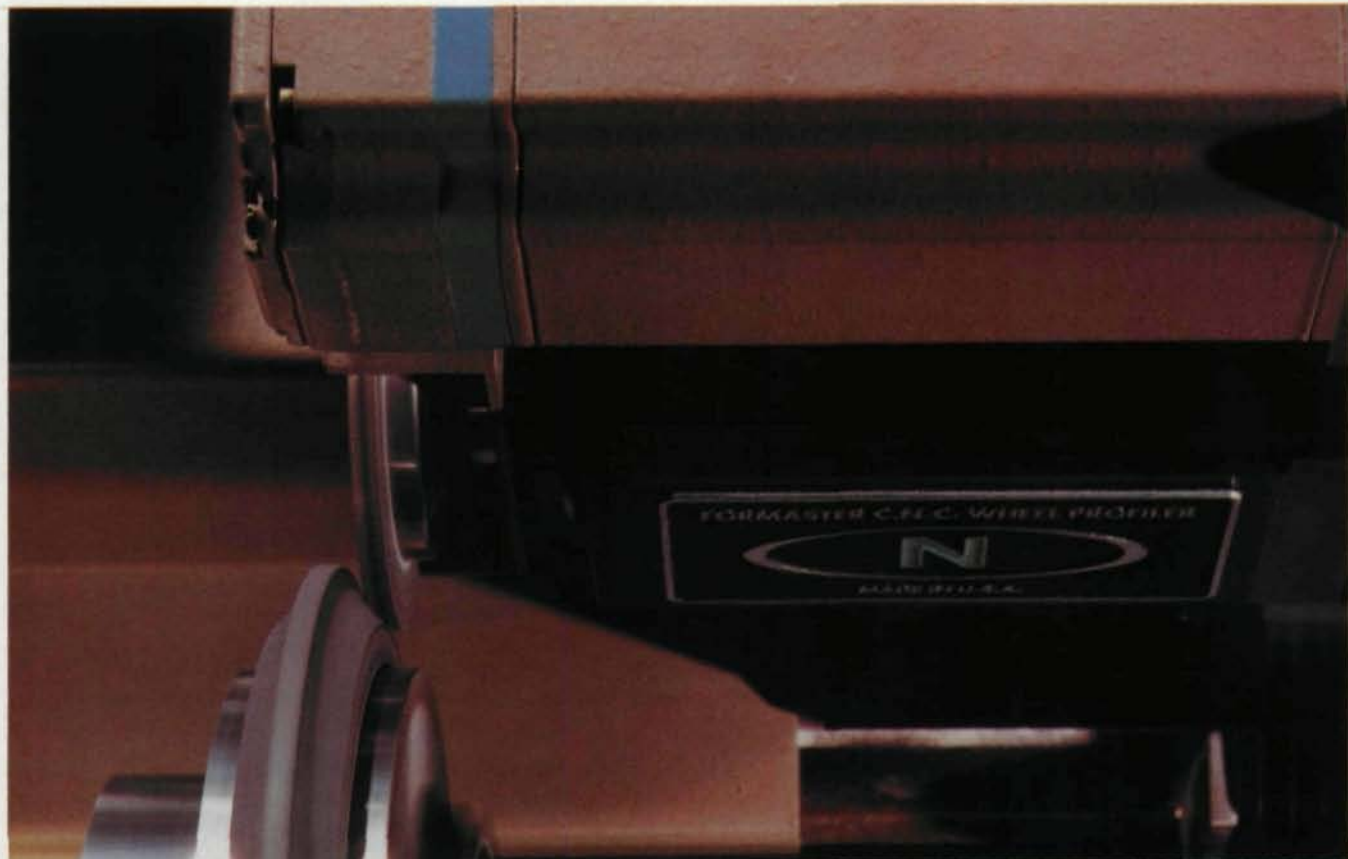

## **FORMASTER... BUILT FOR LASTING ACCURACY AND EASY CONTROL IN GEAR GRINDING APPLICATIONS**

Normac's FORMASTER CNC Grinding Wheel Profiler has been rigidly designed and constructed to resist deflection and maintain an accuracy of  $\pm 0.0001$ " (0.002mm) indefinitely.

Normac's proprietary offline software makes data input quick and easy. This application software, (a collection of programs running on an IBM-PC compatible), completely removes the burden of complicated math calculations and NC programming. You can grind what you design.

An added plus is the FORMASTER'S compact design enabling it to be mounted quickly and easily on old or new gear grinding machines.

*Call or write today to  
arrange a demonstration*



INCORPORATED

P.O. Box 69 / Airport Road Industrial Park, Arden, NC 28704 USA  
Tel: (704) 684-1002 / Telex: 57-7437 Normac Hevl  
Fax: (704) 684-1384

P.O. Box 207 / 720 E. Baseline Road / Northville, MI 48167 USA  
Tel: (313) 349-2644 / Fax: (313) 349-1440

**CIRCLE A-41 on READER REPLY CARD**



# Gear Material Quality: How To Judge It... Pitting: How To Prevent It

Don McVittie

How do we know when the gear material we buy is metallurgically correct? How can we judge material quality when all gear material looks alike?

*Don McVittie replies:* Gear quality has two parts - materials and geometry. Most people find geometry easier to measure and understand, so they emphasize that and ignore material. The most accurate gear is a waste of money, though, if its material is weak or brittle. Only the best materials warrant the time and effort necessary to make an accurate gear.

What makes a gear material bad?

- Too soft for the job.
- Hard enough, but the wrong crystal structure (microstructure).
- Right structure, but too many non-metallic inclusions.
- Cracks, holes, seams, and laps.

Fig. 1 shows the photomicrograph of the core material of a failed gear tooth. The light-colored areas are "blocky ferrite." They show that the gear was hardened in a separate re-heat/quench/temper process after carburizing and cooling, and that it wasn't thoroughly reheated before quenching. Blocky ferrite is weaker than the

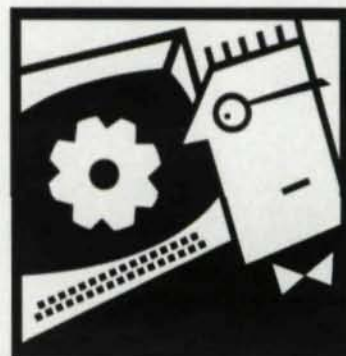

## SHOP FLOOR

Address your gearing questions to our panel of experts. Write to them care of Shop Floor, Gear Technology, P. O. Box 1426, Elk Grove Village, IL 60009, or call our editorial staff at (708) 437-6604.



Fig. 1

### Don McVittie

is President of Gear Engineers, Inc., Seattle, WA. He is a past president of AGMA and Chairman of the U. S. Technical Advisory Group for International Gear Standards. He is a licensed professional engineer in the State of Washington.



Fig. 2

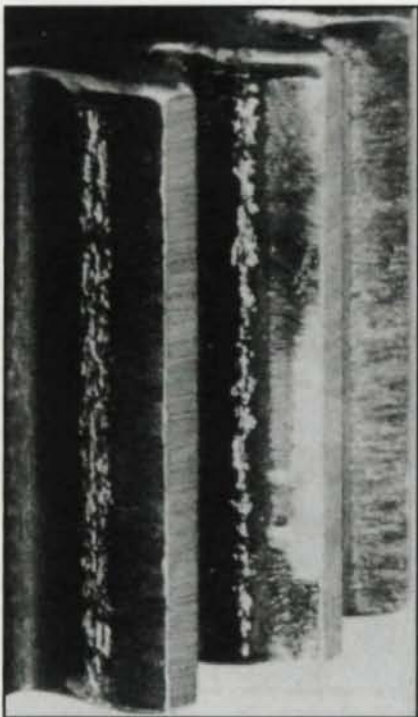

Fig. 3



Fig. 4

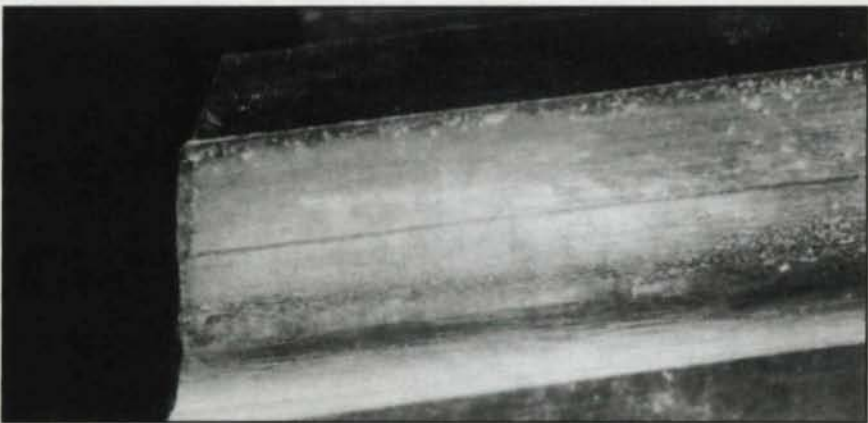

Fig. 5

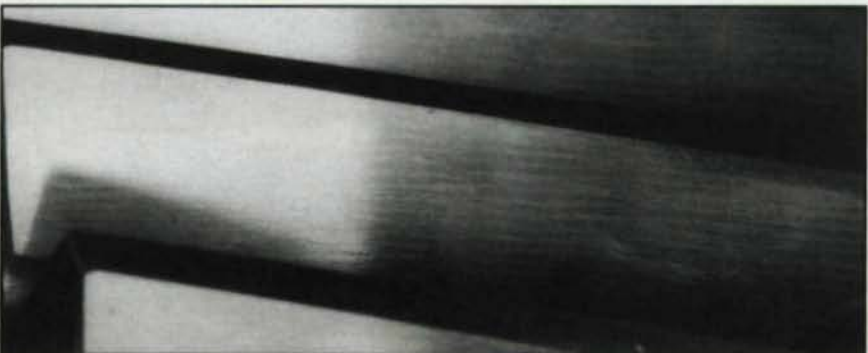

Fig. 6

desired "tempered martensite" structure and is not permitted in highly loaded carburized gears.

How can buyers know what they're getting? After all, the gears look, weigh, and measure the same! The difference is invisible, like good character in an individual, but it's there and will become obvious with time.

If you could look inside a well-made carburized gear, the case microstructure would look like the photo shown in Fig. 2, with a uniform martensitic structure, free from defects.

Material quality is difficult to measure on a finished part because the critical areas are inaccessible. Quality is maintained by carefully controlling the manufacturing process and checking the results each step of the way, from the ingot to final heat treatment and inspection for hardness and surface defects.

Some purchasers have strict material specifications and internal quality control, allowing them to verify the

## SHOP FLOOR

quality of the parts they buy. Others don't have such in-house capabilities, so they buy from vendors who have internal quality controls. These "qualified vendors" utilize quality standards and inspection expertise to get the right materials and processes into the gears as they're made. The remaining buyers take their chances with the lowest bidder.

The American Gear Manufacturers' Association (AGMA) develops industry standards for gear quality, both in geometry and materials. The right quality level can be specified by reference to those standards, avoiding the need to write and maintain in-house documents.

**We have a lot of problems with pitting in our shop. What causes pitting and what is the best way to prevent it?**

*Don McVittie replies:* Pitting can be caused by things other than bad mate-

rial. Abrasive wear and misalignment will do it. So will overload. Fig. 3 shows a gear tooth that has a good contact pattern, but is covered with pits. The pits are caused by excess contact pressure; the material isn't strong enough to withstand the load being applied.

Material below the surface of the gear tooth flows away from the load, much like bread dough under a rolling pin or the top of a rail deforming under the pressure of train wheels. The failure is gradual, with particles of material flaking off into the oil; old pits close in due to the flow of surface material, and new pits form.

Eventually, the small pits join into larger pits, or spalls. The accuracy of the tooth form is destroyed, and the dynamic load on the teeth increases. As the teeth get thinner and rougher, breakage will occur through the stress risers caused by the pits, as shown in Fig. 4.

Theoretically, all gears will pit, even at light loads. In practice, we'd like them to outlast the machines they drive. In most gear drives, the pitting rate is slow enough that it can be tolerated with gear replacement every few years. Sometimes the increased vibration and noise caused by pitting require a more permanent cure.

Fig. 5 shows a form of pitting known as ledge wear, where the portion of the tooth below the pitch line (dedendum) is much more pitted than the portion near the tip (addendum). The tooth is no longer a true involute form. This is caused by a combination of poor lubrication conditions and mild overload. The mating pinion wore in a similar pattern. Such a gear can usually be saved by recutting it and making a new hardened and ground pinion (Fig. 6) that will promote a good lubrication film and hold its accurate profile form under high loads. The accurate pinion acts as a tool to maintain the gear tooth profile.

The real issue, of course, is to prevent pitting failures from occurring at all. Here are some preventative steps:

1. Thicker (more viscous) oil spreads the load over more tooth area and can

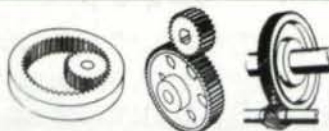

**SPACING/INDEX, LEAD, INVOLUTE PROFILE**



**Roto-Technology, Inc.**

351 FAME ROAD • DAYTON, OHIO 45449  
(513) 859-8503 • FAX # (513) 865-0656 • 1-800-875-7686

See us at **QUALITY EXPO TIME Booth 1950**

CIRCLE A-11 on READER REPLY CARD

- **USER-FRIENDLY  
DOS BASED SOFTWARE**
- **ECONOMICALLY PRICED  
AND SIZED**
- **CHECKS GEARS, SPLINES,  
HOBS AND MUCH MORE**
- **AUTOMATIC TESTING**

**RC-400 GEAR METROLOGY CENTER**



**TRU-VOLUTE®**

*the first name in gear generating tools*

All TRU-VOLUTE gear generating tools are precision ground to the highest accuracy. If proven reliability and consistent accuracy are important to you, then **request TRU-VOLUTE** tools for your next job.

- Proven Durability
- Extensive Stock — All Bore Sizes
- 12 DP and finer
- Available in HSS M42 and Solid Carbide
- TiN and TiCN Coatings
- Introducing Express Delivery and TRU-VOLUTE Class AAA ultimate accuracy tolerances.



**RUSSELL,**

**HOLBROOK**

**& HENDERSON, INC.**

Phone: 201-670-4220 • Fax: 201-670-4266

2 North Street, Waldwick, New Jersey 07463

CIRCLE A-12 on READER REPLY CARD

## Bourn & Koch CBN Form Grinder

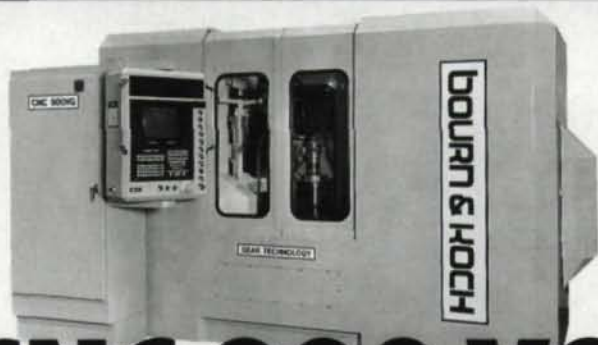

# CNC 900 VG

- Compare features**
- Polymer concrete base-column-tailstock
  - Anti-friction way system
  - Gearless table drive
  - Unique environmental control
  - Industries most powerful conversational programming
  - Design for accuracy, performance and the operator

*For all your gear manufacturing requirements, whether it be new or remanufactured, retrofitted or rebuilt Barber-Colman gear equipment, Bourn & Koch can offer you the "Best Fit Solution."*

**BOURN  
& KOCH**  
MACHINE TOOL CO.

Purchaser of the Barber-Colman Machine Tool Division  
2500 Kishwaukee St.  
Rockford, IL 61104  
815/965-4013 Fax 815/965-0019

CIRCLE A-13 on READER REPLY CARD

increase the capacity of a drive without much cost. It's worth a try with new gears, but can't be expected to cure already-pitted gears.

2. Extreme pressure (EP) additives in the oil also can help. Synthetic oils without additives seem to hurt pitting resistance. Frequent oil changes, particularly when the drive operates with oil temperatures above 160°F, also help.

3. Harder gear materials definitely make a difference. Changing from 180 to 321 Brinell hardness doubles pitting capacity and changing to carburized material doubles it again. The harder materials are more sensitive to misalignment (they can pit before they wear in), so the replacement parts must be made carefully and might require special geometry.

An economical way to repair a pitted through-hardened gear set is to recut the gear, exposing new surface material, and to replace the pinion with a new oversize carburized and ground pinion. The harder pinion will retain its accurate profile, work-hardening and

## SHOP FLOOR

**The most accurate gear is waste of money if its material is weak or brittle. Only the best materials warrant the time and effort necessary to make an accurate gear.**

protecting the gear from profile degradation, greatly increasing its life. ■  
*This material is adapted from Pitch Lines, the bimonthly newsletter of The Gear Works, Seattle, WA. Reprinted with permission.*

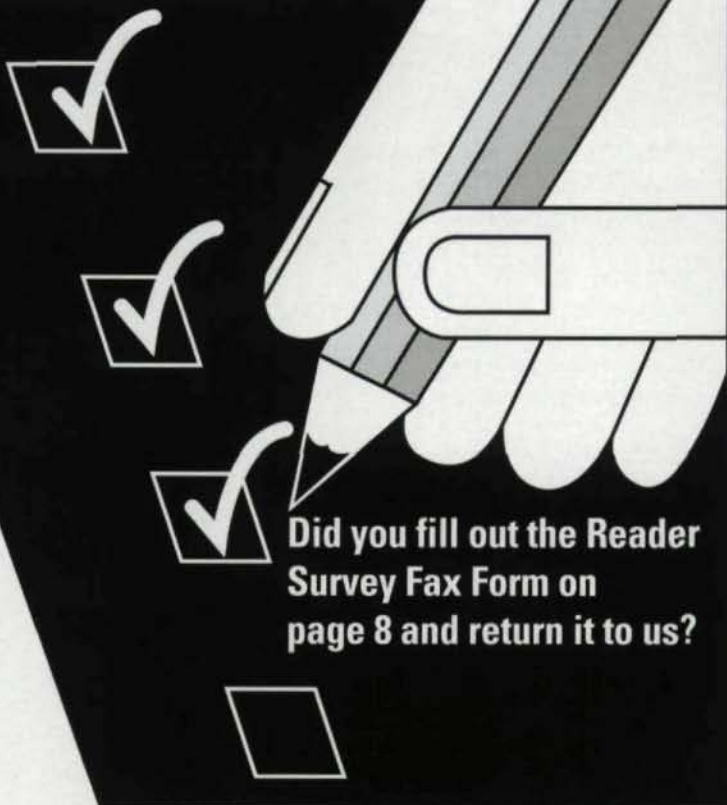

**Did you fill out the Reader Survey Fax Form on page 8 and return it to us?**

**YOUR OPINIONS MATTER TO US!**



# NEW 1993 BUYERS GUIDE

## 1993 Buyers Guide COMPANY INDEX

Use this directory to find the addresses and phone numbers of manufacturers and companies in your area. For more detailed information about other advertisers, see the other directories. Use this directory to find the addresses and phone numbers.

### - A -

**ABBOTT GEAR CUTTING MACHINERY, INC.**, 1500 Waycross Blvd., Cincinnati, OH 45333. (513) 555-0000 FAX (513) 555-1111.

**ABC GRINDING COMPANY**, 123 First Avenue, Albany, New York 12345. (518) 123-6666, (800) 999-0000 FAX (518) 123-1111.

**ACOURT HOBBING & FINISHING** P.O. Box 815, Joplin, MO. 43210 (417) 122-9999.

**AGE OLD METAL T FINISHING** 15937 W Fargo, ND (701) 111-2222 4567 FAX (701) 123-4567

**AROLD INDUSTRIAL** South Street, Montgomery, AL 987-6543 FAX (205) 987-0000

**ARNOLD INDUSTRIAL**

937 South Street Montgomery, AL Phone: 678-8907

**BEST GEAR IN TOWN**

**ARROW BROTHERS MACHINES CO., INC.** Ave. Elk Grove, Il 6778 815, Joplin, MO. 43210 9999, (800) 999-0980. F 8907 Fax anytime.

**ASTRO INDUSTRIAL, INC.** 15937 West Highway, Fargo, ND (701) 111-2222 (800) 123-4567 FAX (701) 123-4568. CALL ANYTIME.

**AUBURN INDUSTRIAL GEARS** 937 South Street, Montgomery, AL (205) 987-6543 FAX (205) 987-0000.

**AVON GRINDING & FINISHING**, 1500 Waycross Blvd., Cincinnati, OH 45333. (513) 555-0000 FAX (513) 555-1111.

**AVTRON GEAR CUTTING**, 123 First Avenue, Albany, New York 12345.

123-6666, (800) 999-0000 FAX (518) 123-1111. Fax anytime.

**BBC HOBBING MACHINES** P.O. Box 815, Joplin, MO. 43210 (417) 9999.

**BACK TO BACK TREATING & FINISHING** 15937 West Highway, Fargo, ND (701) 111-2222 (800) 123-4567 FAX (701) 123-4568

**BENDT INDUSTRIAL GEARS** 937 South Street, Montgomery, AL (205) 987-6543 FAX (205) 987-0000.

## 1993 Buyers Guide GEAR PRODUCTS INDEX

Use this directory to find the addresses and phone numbers of suppliers of the products and services you need. Some suppliers may appear in more than one category. Advertisers are listed alphabetically in Company Index.

### GRINDERS

**ABBOTT GEAR CUTTING MACHINERY, INC.**, 1500 Waycross Blvd., Cincinnati, OH 45333. (513) 555-0000 FAX (513) 555-1111.

**A & K GRINDING**, 123 First Avenue, Albany, NY 12345.

**Best Grinding Machines In Town.**

**A & K GRINDING**  
123 First Avenue,  
Albany, New York 12345.

**ARNOLD INDUSTRIES, INC.** 937 South Street, Montgomery, AL (205) 987-6543 FAX (205) 987-0000.

**Arnold INDUSTRIES, INC.**

For Arnold Customer Service nearest you... Call Toll Free 1-800-666-8989

**AUGHLIN HOBBING MACHINES CO., INC.** 123 Northwest Highway Elk Grove Village, Il 67778 P.O. Box 815, Joplin, MO. 43210 (417) 777-9999, (800) 999-0980 Fax (889) 564-8907 Fax anytime.

**AVOLD WORLD MACHINERY, CO., INC.** 15937 West Highway, Fargo, ND (701) 111-2222 (800) 123-4567 FAX (701) 123-4568

**AZENDT INDUSTRIAL GEARS** 937 South Street, Montgomery, AL (205) 987-6543 FAX (205) 987-0000.

### HOBBERS

**ABBOTT & CASTRO HOBBERS**, 1500 Waycross Blvd., Cincinnati, OH 45333. (513) 555-0000 FAX (513) 555-1111. CALL TODAY.

**ACORN MACHINERY, INC.** 123 First Avenue, Albany, NY 12345. (518) 123-6666, (800) 999-0000 FAX (518) 123-7895. Call us today.

**ALD WORLD MACHINERY** 15937 West Highway, Fargo, ND (701) 111-2222 (800) 123-4567 FAX (701) 123-4568. CALL TODAY.

**ALD WORLD MACHINERY**

5937 West Highway, Fargo, ND PHONE: (701) 111-2222 PHONE: (800) 123-4567 FAX: (701) 123-4568

- Trade-Ins
- Cutting Tools
- Rebuilding Services
- Helpful Customer Service

**BBC INDUSTRIAL PRODUCTS** 937 South Street, Montgomery, AL (205) 987-6543 FAX (205) 987-0000.

**BBC**

937 South Street Montgomery, AL 78926

**BBC Industrial Gears**

**BAUGHLIN HOBBING MACHINES** P.O. Box 815, Joplin, MO. 43210 (417) 9999.

**BACK TO BACK MACHINERY** 15937 West Highway, Fargo, ND. P.O. Box 567 (701) 111-2222 (800) 123-4567 FAX (701) 123-4568.

### SHAPERS

**B & B INDUSTRIAL PRODUCTS** 937 South Street, Montgomery, AL (205) 987-6543 FAX (205) 987-0000.

**BAKERS GEAR CUTTING MACHINERY, INC.**, 1500 Waycross Blvd., Cincinnati, OH 45333. (513) 555-0000 FAX (513) 555-1111.

**BUTLER PRODUCTS**, 123 First Avenue, Albany, New York 12345. (518) 123-6666, (800) 999-0000.

**DALTON MACHINES** P.O. Box 815, Joplin, MO. 43210 (417) 9999. or 1-800-678-2169

**W**ind up your ad year with a high-precision shot at your target market. Get a listing - or several - in our **NEW BUYERS GUIDE**, appearing as a special supplement in our NOVEMBER/DECEMBER issue.

**A listing in the Buyers Guide gets you:**

- Constant visibility throughout the year.
- A target audience of 36,000 buyers & specifiers from around the world.
- A choice of listings, display ads, or both to maximize your presence and visibility.

Divided into a company name listing and the major industry product and service categories, this user-friendly, easy-to-read directory will be used and kept as a ready reference by our readers.

**A directory listing in this important industry reference is \$250.**

**A display listing is \$350 per inch with 2-inch minimum.**

As a special, introductory offer, 1 page, 4-color advertisers get one **FREE DIRECTORY LISTING** and 30% OFF on additional listings. Other display advertisers get **10% OFF** on all directory listings.

**Make the BUYERS GUIDE part of your advertising plans for 1993. For further information call (800) 451-8166**

# Controlling Carburizing for Top Quality Gears

Roy F. Kern  
Kern Engineering Company,  
Peoria, IL

A carburized alloy steel gear has the greatest load-carrying capacity, but only if it is heat treated properly. For high quality carburizing, the case depth, case microstructure, and case hardness must be controlled carefully.

The depth of penetration of carbon into a gear tooth is a function of carbon potential of the atmosphere, temperature, time, and composition of the steel. Problems with the production carburizing of parts start with the question: How and where is case depth to be measured?

Many gear drawings and/or carburize specifications require that the case depth be the distance inward, measured normal to the tooth flanks where a certain hardness occurs. Universally, the depth is measured as that distance to where a hardness of 50 Rockwell C occurs. The most significant test location is at the lowest point of single tooth contact (LPSTC) midway between the ends of the teeth.

This is much more complicated than carbon penetration because this hardness is affected not only by the carbon content of the steel, but also by its hardenability, the mass of the tooth, and, of course, the vigor of the quench.

The first step in case depth control is to make sure that the gear's mass, the hardenability of the steel in the gear, and the quench available indicate that there is a possibility to meet the case depth requirements. The most difficult part of this process is to estimate the vigor of the quench. This is done using the Jominy end-quench specimen showing in Fig. 1.

The upper left-hand corner of Fig. 1 shows how an end-quench test is performed.

The specimen is heated to a hardening temperature and then quenched on one end with water. The closer to the end, the more drastic the quench is, and the harder the steel becomes, as seen in the twice-scale drawing at the bottom of the figure.

Note that at 1/16" from the quenched end, the hardness is 45 Rockwell C. At 3/16" it is 41

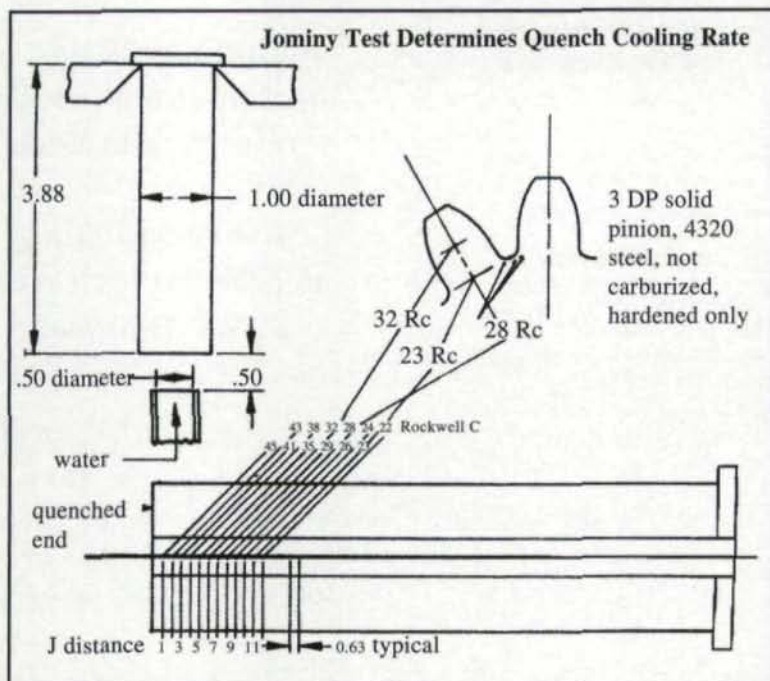

Fig. 1 - The upper left-hand corner of the figure shows how an end-quench test is performed with the Jominy end-quench specimen. One of the most difficult parts of case depth control is estimating the vigor of the quench.

Rockwell C, and at 6/16" it is 32 Rockwell C. If a 3 DP solid pinion were made from this same steel, the core hardness at the pitch line would be 32 Rockwell C, so the quench cooling rate at the pitch line would be equal to 6/16" on the Jominy test specimen - commonly referred to as J6. In the root fillet, the gear would have hardened to only 28 Rockwell C, which is approximate J8. This has been done for both web-type gears and solid pinions, as shown in Fig. 2, and for round bars, as shown in Fig. 3.

For example, Fig. 2 shows that the quench cooling rate in the root fillet of a 4 DP solid pinion with an agitated oil quench corresponds to 6/16J or J6. The root fillet was chosen because it is close to the LPSTC, and its quench-cooling rate is quite similar.

For 9310 Steel, Fig. 4 shows all that is needed at the required case depth (to 50 Rockwell C) is 0.30% carbon. So if 0.060" case depth is required, the carburized depth to 0.30% carbon should be 0.060 plus approximately 0.010" or 0.070". This also is true of steels, such as 3310, 4820, and EX-55.

#### Lean Alloys

With steels, such as 8620H and other lean alloys, close control of case depth becomes much more difficult. This is because the hardening qualities of these steels vary widely with the manufacturer.

The 4 DP solid pinion in Fig. 4 shows that from 0.45% to more than 0.60% carbon is required at the specified depth below the surface, depending on steel source, to harden to 50 Rockwell C. This variation is so great that for precise control of case depth the heat treater should run suitable carburizing tests on samples from each heat of steel before running parts.

Beyond the hardenability of the steel, an important factor in the control of case depth is the use of a sample whose surface quench-cooling rate is the same as that at the test location on the gear, for example, at the LPSTC or in the root fillet. Because there are quench cooling rates in the root fillets for different types and pitches of gears and for different size rounds, heat treaters can plot the equivalents.

This is important because it often is economically impractical to cut a gear to check case depth. Fig. 5 shows a suggested sample design and table of sizes for different size gears.

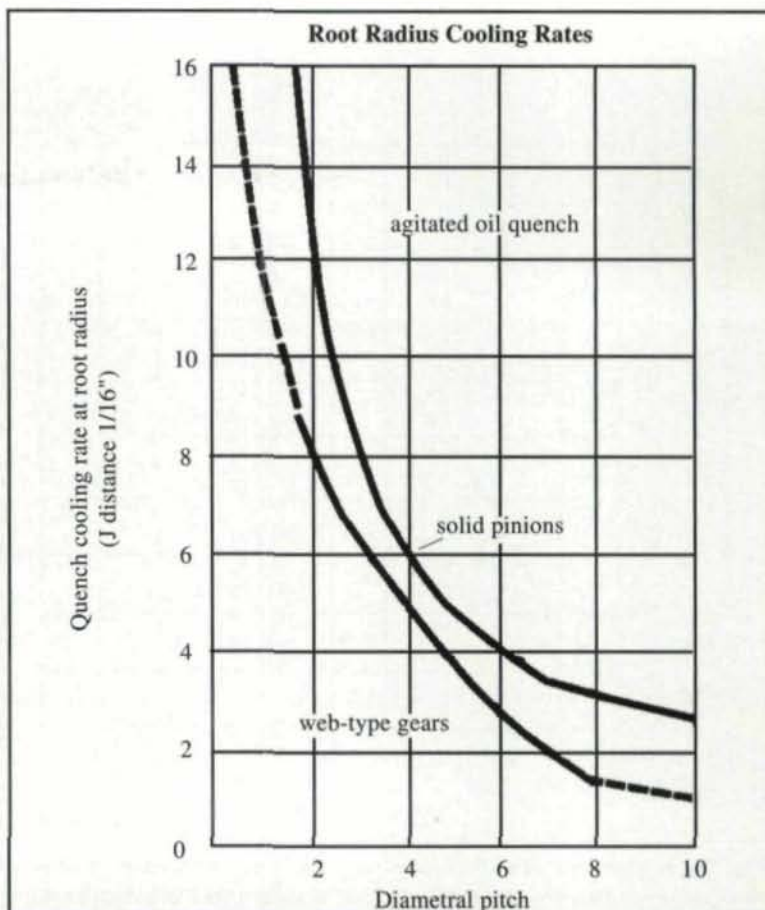

Fig. 2 - The quench cooling rate in the root fillet of a 4 DP solid pinion with an agitated oil quench corresponds to 6/16J or J6.

Unless otherwise specified, the case depth is determined by carefully cutting a 0.25"-thick transverse slice from the sample's center. The slice is further reduced in size so it can be polished to a suitable microscopic finish. The hardness probe then is run from the surface through the carburized case, using a graduated stage with the first reading at 0.001" and the balance at 0.005" steps. Either a Knoop or Vickers hardness tester is satisfactory.

The vigor of the quench also influences the case depth, and yet tests and surveys have shown that this important factor has received little attention in gear hardening.

#### Temperature Dependency

Case depth depends on the temperature at which the operation is carried out. There are three factors to keep in mind regarding the effect of temperature on case depth:

- The furnace thermocouple must indicate the temperature of the work.
- The furnace thermocouple performance must be traceable to at least a secondary master standard calibrated by the National Bureau of Standards.

#### Roy F. Kern

is president of Kern Engineering Co., a design and materials engineering firm. He is an active member of the American Society for Metals and the author of numerous books and papers, including *Selecting Steels for Heat Treatment and Steel Selection* with M. Suess for John Wiley and Sons, New York.

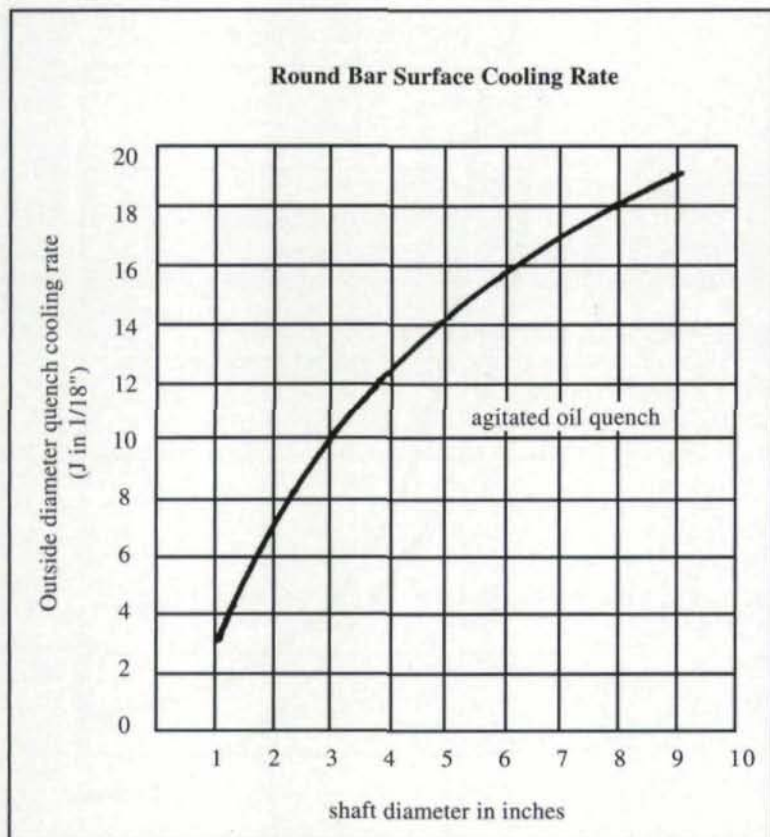

Fig. 3 - In the root fillet of round bars, the gear hardened to only 28 Rockwell C, which is approximately J8. Surface outside diameter cooling rate is expressed as J distance of round bars quenched in agitated oil.

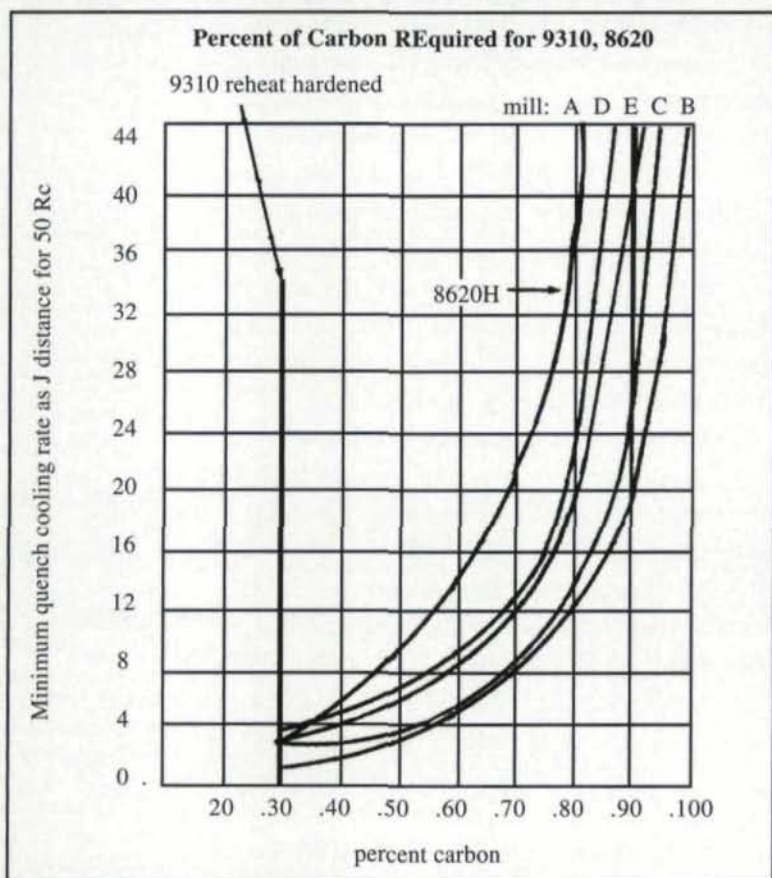

Fig. 4 - With 9310 steel, all that is needed at the required case depth - to 50 Rockwell C - is 0.30% carbon. Depending on manufacturer, 8620 steel requires much more carbon.

- The temperature control device must be operating properly, which is assured by a scheduled and thorough maintenance program.

It is not uncommon for the furnace thermocouple to be, for example, at 1700°F/927°C while the work, depending on mass, is 200°F/93°C or more lower. The experienced heat treater looks into the furnace as parts are being heated to ensure that they are coming to heat as uniformly as possible.

#### Case Microstructure

In a carburized gear, microstructure is extremely important. The desired combination for the case is martensite, austenite, and finely dispersed carbides. This structure must be free of microcracks.

The usual deficiencies are excessive amounts of retained austenite, carbide network, or quenching pearlite, which often is called upper bainite. When it is impractical to cut a gear, specimens as shown in Fig. 5 can be used.

What constitutes excessive amounts of retained austenite is a much debated matter. However, if a case hardness of at least a 58 Rockwell C is obtained, the amount of austenite present usually is not excessive. Still, a case hardness of 60 Rockwell C is preferred. The causes of excessive austenite are one or a combination of the following:

- The steel being used contains too much nickel and/or manganese for the heat treating practice employed.
- Carbon content of the case is excessive, for example, 1.10% in 4820 steel, when 0.8% is adequate.
- Quench is extremely intense.

A reasonably reliable test for excess austenite is to find a gear quite file-hard, but Rockwell C soft, for example, in the low 50s. Parts having excessive retained austenite can be salvaged in more than one way.

If direct-quenched, the parts should be tempered at 500°F/260°C, reheated above the Ac of the core, and requenched. For steels such as 4817 and 4820, a two- to three-minute delay or greater resulting in cooling to 1300°F/704°C to 1350°F/732°C between the hardening furnace and the quench also will reduce the retained austenite.

Another way to salvage a part with exces-

sive retained austenite is to temper the parts at 500°F/260°C and then charge in a carburizing furnace at 1700°F/927°C to decarburize the part surface down to the proper level. After slow cooling, reheat to a temperature 25° to 50° above the Ac of the core and quench.

Because it may substantially reduce the bending fatigue qualities of a gear tooth, low-temperature treating at least down to -100°F and retempering at 325°F/163°C to 350°F/177°C is not a recommended method of reducing retained austenite.

Another important element in carburized case microstructures is the carbide morphology. Network carbide is not permitted due to its weakening and embrittling effects on gear teeth. Carbide network is always the result of excessive case carbon content and/or inadequate hardening in temperature. The condition can only be detected in production by microscopic examination of the carburized surface of a part or a slice from the sample.

The prevention of quenching pearlite, widely called upper bainite or simple bainite, is an additional element in controlling the carburized case microstructure. This constituent is soft, usually 30 to 40 Rockwell C. It also is weak and deleterious to pitting life, as shown in Fig. 6.

### Quenching Pearlite

The heat treating operation can be at fault for quenching pearlite formation due to the following:

- Inadequate case carbon content,
- Excessive transfer time from the hardening furnace into the quench,
- Inadequate quench intensity.

To get a steel to harden free of quenching pearlite, it must be cooled fast enough to avoid the "nose" on the IT curves, down to at least the M line; however, M is desired.

The main reason for the presence of quenching pearlite in gears is sluggish quenching. Leading edge heat treating firms avoid this undesirable constituent with vigorous quenching and also reduce steel cost with lower cost alloy.

The extreme importance of preventing quenching pearlite warrants discussion of some steps to be taken in the choice process. Each alloy steel, depending on the case carbon and

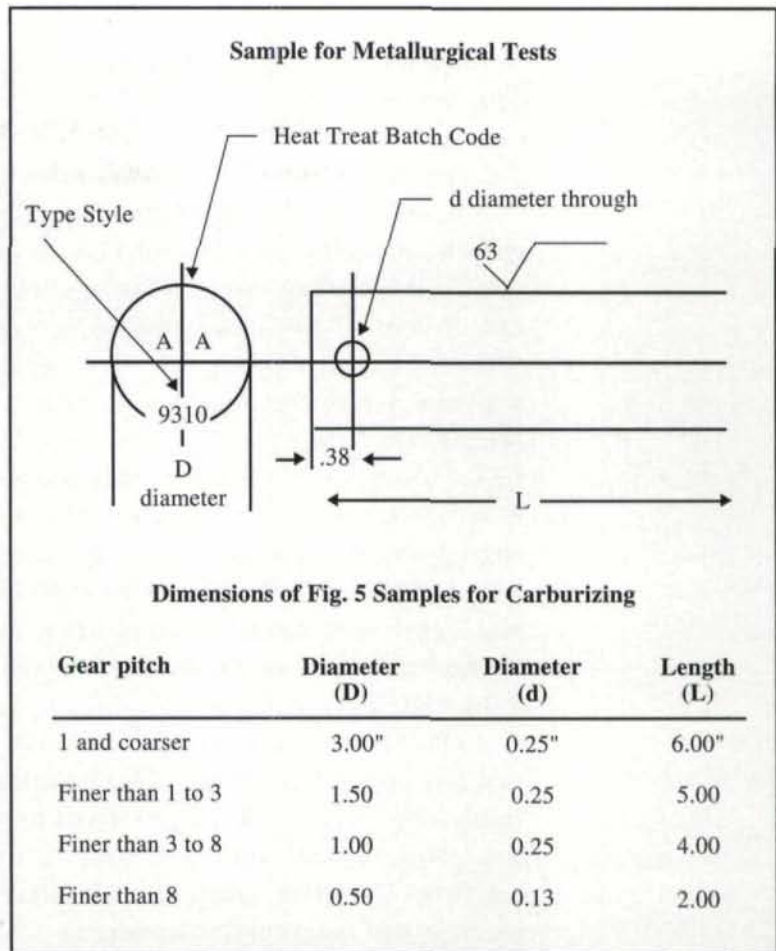

Fig. 5 - When it is economically impractical to cut a gear to check case depth, a heat treater can use a sample design and table of sizes for different size gears.

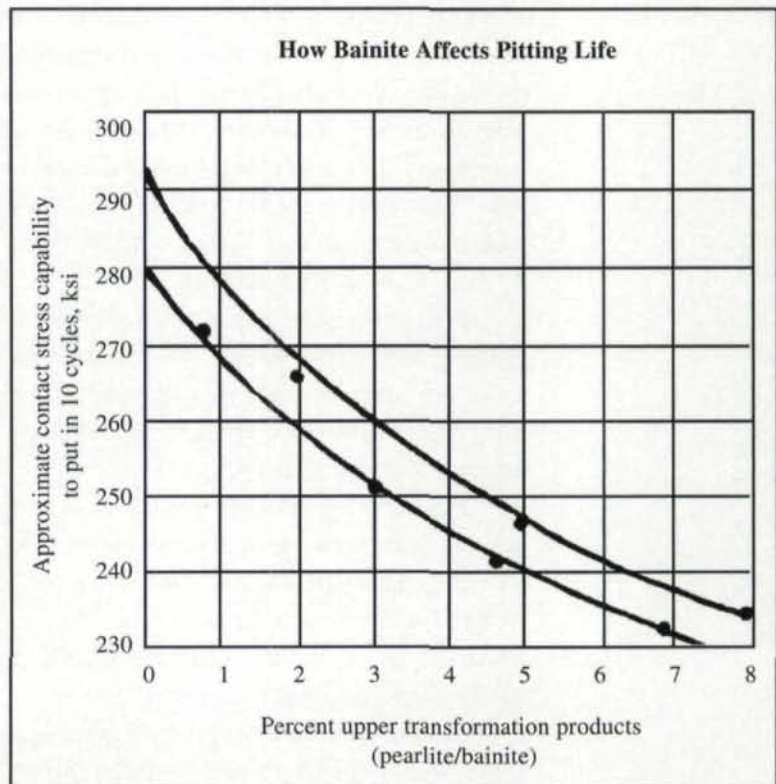

Fig. 6 - Bainite, also call quenching pearlite, is soft, weak, and deleterious to pitting life.

carburizing practice, has a quench-cooling rate in J distance below which quenching pearlite will form. Fig. 7 gives the typical cooling rates, most of which would be greater for a case carbon content less than 1.00% carbon.

For a 4 DP solid pinion, for example, the quench-cooling rate in the root fillet is 6/16"J (0.375). If 1.00% case carbon is to be used by carburizing at 1700°/927°C, cooling to 1500°F/816°C and direct-quenching, only a few steels will harden with freedom from quenching pearlite. They are 3310, 4320, 4620, 4817, EX-24, EX-29, EX-31, 8822, and 94B17. Steels 3310, 9310, and 4817 will contain excessive amount of retained austenite with 1.00% case carbon. If the part is to be carburized to 1.00% case carbon, slow cooled, and then reheated for hardening, these steels will work: 3310, 9310, 4320, and EX-31.

Of the two general types of quenching, the first is a surface layer of quenching pearlite frequently associated with intergranular oxidation and/or partial decarburization. It usually is only 0.0015" to 0.002" maximum thickness, and of no significant engineering effect.

The second type is found as dark patches deep into the surface. If 10 or greater stress-cycle life is required, no quenching pearlite should be present. If 10 cycles are adequate, 3% maximum of quenching pearlite is acceptable.

Positive control of quenching pearlite can only be done by microscopic examination of a sample cut from a gear or a slice of the specimen. Examination should be at 400X to 500X with a two-to four-second etch with 2% Nital.

#### **Microcracking**

Microcracking also must be considered in suitable carburizing control. Such cracks are more prevalent in steels in which the major alloying elements are carbide formers, for example, 4120 and 8620.

Case carbon content and quench vigor also play an important role in microcracking. For example, gears 8 DP and finer made from 8617 or 8620 will microcrack, even when reheat-hardened, when the case carbon is 0.90% or greater, and the oil quench is well agitated.

Heat treaters sometimes resort to water or a thin polymer quench to achieve the specified hardness on carburized steels such as 5120 or 8620, but this usually results in severe

microcracks. Microcracks adversely affect bending fatigue life, although it varies with the severity and location of the cracks.

In the case of bending fatigue life of a 8620 steel that was reduced by a factor of 1,000, the problem was solved by going to a 4020 analysis steel — 1018 plus 0.20/0.30% molybdenum. It is best to select material and heat treat processing so there are no microcracks, which is an achievable objective. If a few micro-cracks are found on a single test, the chances are very good that higher side heats will be more severely cracked with significantly shortened lives.

A slice from a sample or from a section of a scrap gear can be used for the microcrack specimen. The etch must be very light, for example, 2% Nital for two seconds. With a more or less normal etch, the microcracks will be invisible.

Although the hardness test is a crude approximation of the metallurgical quality of high quality carburized gears, it should be performed at least once at the specified test location on each part. Preferably a minimum of three tests should be made and the average reported. There is some evidence that the contact stress capability of a carburized gear is a function of its hardness.

The test location is very important, especially on gears 6 DP and coarser. The best locations from a design standpoint are at the LPSTC for contact stress capability and the root fillet for strength.

Coarse pitch gears are troublesome. The case carbon content is highest at the tips of the teeth and decreases along the tooth flank to the root fillet. Also, if the quench is close to being deficient, the tips of the teeth might be hard, but not so with the case at the LPSTC and root fillet, because of the lower carbon and less effective quench mainly due to vapor-pocket formation.

When gears cannot be cut up, there are hardness testers that can nondestructively make pitch line and root fillet tests. Another means of closely estimating the case hardness at the LPSTC or in the root fillet is to test the surface hardness of the metallurgical requirement samples as shown in Fig. 5. Usual case hardness requirements are 58, 59, or 60 Rockwell C minimum with a range of plus 5, 6, or 7 points.

A fast but very discriminating hardness tester is a high-quality file. There is a certain amount

### Microstructure Capabilities of Carburizing Steels

Composition <sup>b</sup>	J distance to first bainite <sup>a</sup>			
	Direct-quench <sup>c</sup>		Reheat-quench <sup>d</sup>	
	typical (inches)	estimated minimum (inches)	typical (inches)	estimated minimum (inches)
10B16 (1.00 Mn, 0.17 Cf, 0.07 Mo)	0.138	0.075	0.122	0.062
1018	0.075	0.050	0.055	0.030
10B22 (0.84Mn)	—	0.075	0.105	0.062
15B24 (1.40 Mn)	0.122	0.100	0.116	0.100
1117 (1.27 0.06 Cr)	0.122	0.062	0.116	0.062
1118	—	0.062	—	0.075
1213	0.122	0.062	0.118	0.062
1524	—	0.100	—	0.100
3310	2.000+	2.000	2.000+	2.000
4118	—	0.062	0.085	0.075
4120 (0.8 Mn, 1.00 Cr, 0.05 Ni, 0.25 Mo)	—	0.075	0.114	0.100
41B16	—	0.100	0.186	0.125
4320	0.960	0.875	—	0.875
4620 (with 0.40 Mo)	—	1.250	0.250	0.200
4620	—	0.750	0.272	0.250
4817	2.000+	2.000	2.000+	2.000
5120	—	0.050	0.080	0.062
8620	0.232	0.200	0.108	0.100
8720	—	0.300	0.132	0.100
8822 (low side)	—	0.750	0.189	0.185
8822 (medium composition)	1.270	1.000	0.300	0.250
X9115	—	0.075	0.104	0.075
9120	—	0.075	0.084	0.075
94B17	—	0.500	0.173	0.150
EX-15 (1.00 Mn, 0.50 Cr, 0.16 Mo)	—	0.200	0.116	0.100
EX-24 (0.87 Mn, 0.55 Cr, 0.25 Mo)	0.385	0.300	—	0.200
EX-29 (0.87 Mn, 0.55 Cr, 0.35 Mo, 0.55 Ni)	0.760	0.750	—	0.300
EX-31 (0.80 Mn, 0.55 Cr, 0.35 Mo, 0.85 Ni)	2.000	2.000	—	2.000
20 Mn Cr4	0.375	0.285	0.188	0.100
16 Mn Cr5	0.375	0.250	0.188	0.150

<sup>a</sup> In inches at 1.00%.  
<sup>b</sup> Composition given for nonstandard and experimental steels only.  
<sup>c</sup> Direct-quench consists of carburizing at 170°F, cooling to 1550°, and quenching.  
<sup>d</sup> Reheat hardening consists of carburizing at 1700°F, slow cooling to room temperature, reheating to 1550°F, and quenching. No tempers.

Source: Climax Molybdenum Co.

**Fig. 7 - Each alloy steel, depending on case carbon and carburizing practice, has a quench cooling rate in J distance below which quenching pearlite forms. Listed above are typical cooling rates, most of which would be greater for a case carbon content less than 1%.**

of art required to run the test, but generally it consists of just laying a file on the surface to be tested, applying a moderate amount of downward pressure, and then moving the file slightly forward. If the file "bites," the hardness is questionable. If another application of the file to the same area removes metal, the surface is file-soft. This test will detect partial decarburization and structures with quenching pearlite. ■

#### References:

1. Kern, R. F. "Control of Carburized Case," Heat Treating, March, 1985, pp. 22-3.
2. Kern, R. F. "Effect of Manganese & Nickel on the Hardening Capability of 8620 and 8822 Steels."

Unpublished, 1985.

3. Kern, R. F. and M. Suess. *Steel Selection - A Guide for Improving Performance & Profit*. John Wiley and Sons, New York, 1979, p. 186.

4. Kern, R. F. "New Dimension in Selecting Carburizing Steels," Metal Progress, October, 1972, p. 127.

**Acknowledgements:** Based on a paper presented at the AGMA Technical Education Seminar, May 8, 1990. The original paper is copyrighted by AGMA and used with permission. AGMA states that the opinions, statements, and conclusions in the paper are those of the author and in no way represent the position or opinion of the association. This version of the article is reprinted from the March, 1991, issue of *Heat Treating* magazine. Used with permission.

# Dual Frequency Induction Gear Hardening

**John M. Storm & Michael R. Chaplin**  
**Contour Hardening, Inc.,**  
**Indianapolis, IN**

## **Introduction**

In the typical gear production facility, machining of gear teeth is followed by heat treatment to harden them. The hardening process often distorts the gear teeth, resulting in reduced and generally variable quality. Heat treating gears can involve many different types of operations, which all have the common purpose of producing a microstructure with certain optimum properties. Dual frequency induction hardening grew from the need to reduce cost while improving the accuracy (minimizing the distortion) of two selective hardening processes: single tooth induction and selective carburizing.

Single tooth induction hardening is performed with a shaped intensifier that oscillates back and forth in the gear tooth space. It is usually done with the gear submerged in quench. The process is relatively slow because only one gear tooth space is processed at a time.

Selective carburizing is an industrial standard most widely used to selectively harden gears. The process involves covering the surfaces to be protected against carburizing with a material that prevents the passage of active carbon during the furnace operation. The most widely used method to stop carbon activity is copper plating. A gear is copper plated on all surfaces except the teeth, then carburized. The part is then copper stripped, finish machined, re-copper plated all over, furnace hardened, and quenched.

Dual frequency heating is the fastest known way of heating a gear. Heating times range from .14 to 2.0 seconds. Because it is so fast, surfaces remain clean and free from carbon-depleting and scale, and the core material retains its original properties.

The focus on manufacturing today is to make consistently high quality products at lower costs. This article describes the dual frequency process along with comparisons of other heat treating processes and actual heat cycle data.

## **Dual Frequency Process**

The principle of dual frequency heating employs both high and low frequency heat sources. The gear is first heated with a relatively low frequency source, providing the energy required to pre-heat the mass of the gear teeth. This step is followed immediately by heating with a high frequency source. When applied, the high frequency source will rapidly final heat the entire tooth contour surface to a hardening temperature.

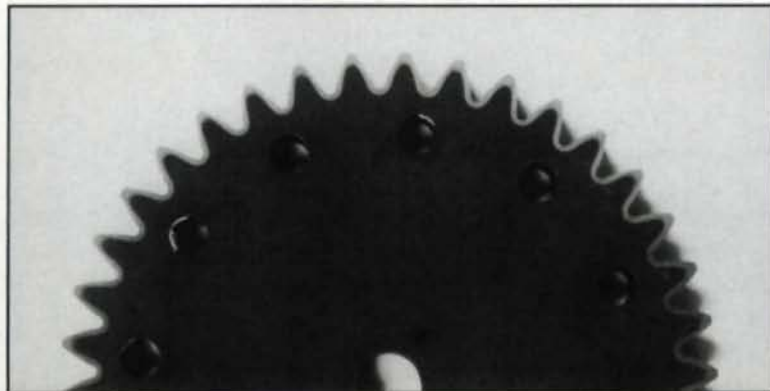

**Fig. 1 - Contour gear hardening pattern.**



The gear is then quenched to a desired hardness. Figs. 1 and 2 show a typical "dual frequency" contour hardened pattern.

The total time cycle is dependent upon the surface area to be hardened. See Table I.

### Material Requirements

There have been vast amounts written about material requirements in terms of wear, machinability, mechanical properties, and the ease with which complicated shapes may be produced by casting methods. In general, a wide variety of materials can be used for the production of gears. For technical and economic reasons, steels have attained a major importance.

The transformation which the structure of steel undergoes during heating and subsequent cooling, particularly the formation of martensite on quenching, is essential for the hardening and tempering of steel. The carbon content of steel establishes the maximum hardness that the steel can reach. Commonly used induction steel requires a carbon content of .40/.50/.60%, depending on the desired surface hardness.

Parts which have to be hardened by quenching after local heating must be made of a steel which contains the carbon necessary to achieve a desired hardness, as shown in Table II.

### Heat Cycle Test

Ideal contour induction processes rapidly heat with only the required energy to transform a desired volume of material; i.e., the contour surface of a gear, and allow for extreme, rapid quenching to take place. This "mass quenching" effectively produces a maximum surface hardness from the material and the best condition of microstructure available (fine grain martensite).

The real problems associated with the heat treating of gears are the result of the numerous processes added to the manufacturing sequence to correct for distortion caused by heat. Most gear producers work from green specs and hard specs, before and after heating, in the hopes of accurately predicting the amount of change that will take place because of heating. This typically involves machining over/between pins, lead, and involute dimensions to values different from final print requirements. In this mode of operation, the manufacturer treats the symptoms and not the true problem. In treating the symptoms, a sizeable increase in gear production cost is generated. The major elements that produce the increased costs include materials, time, energy,

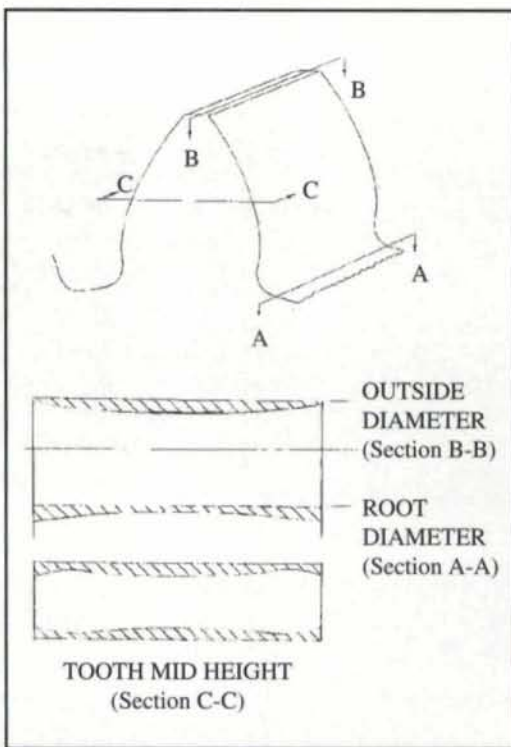

Fig. 2 - Typical tip and root pattern.

Table I - Dual Frequency Process

#### Gear Data

Number of teeth .....	58
Outside diameter .....	7.500
Root diameter .....	6.930
Face width .....	.490
Material .....	SAE 5150
Approximate surface area =	27 square inches

#### Dual Frequency Cycle Process

		(spindle rpm)
* Pre-heat	10 seconds	300
* Dwell	3 seconds	
* Final heat	.455 seconds	400
* Quench	15 seconds	5
* Temper	3 seconds	300

#### Dual Frequency System

- \* Pre-heat low frequency generator (3-10k)
- \* Final heat high frequency generator (100-230kc)
- \* Work station with quench system
- \* Computer control station

Table II

RC	CARBON
50	.40%
55	.45%
60	.51%

### John M. Storm

is Vice President of Research and Development at Contour Hardening, Inc. He has worked for nearly twenty years in heat treating process research and, along with Michael Chaplin, has been granted a patent for the Micropulse contour hardening system. He is a member of SME, ASM, and AGMA.

### Michael R. Chaplin

is Vice President of Engineering at Contour Hardening, Inc. He has 28 years' experience in gear box design and gear development in aerospace and transmission applications. He is currently Chairman of the AGMA Vehicle Gearing Committee and U.S. delegate to the ISO Committee TC/32.

**Table III**

Comparison of Dual Frequency Induction Gear Hardening and Selective Carburizing

**DIE QUENCH OPERATION**

1. Rough Machine
2. Degrease
3. Mask
4. Copper Plate
5. Unmask
6. Inspect Plate
7. Load Carburize Furnace
8. Slow Cool
9. Clean
10. Copper Strip
11. Finish Machine Gear Teeth
12. Load Hardening Furnace
13. Die Quench
14. Degrease
15. Draw (temper)
16. Shot Blast (clean)
17. Inspect
18. Required Finishing Operations

**FREE QUENCH OPERATION**

1. Rough Machine
2. Semi-finish Gear Teeth
3. Copper Plate
4. Unmask
5. Inspect Plate
6. Load Carburize Furnace
7. Quench
8. Draw (temper)
9. Degrease
10. Shot Blast
11. Copper Strip
12. Shot Blast
13. Inspect
14. Required Finishing Operations

**DUAL FREQUENCY OPERATION**

1. Rough Machine
2. Core Treat
3. Degrease
4. Draw
5. Finish Machine (final size)
6. Load Induction Machine
7. Unload
8. Inspect

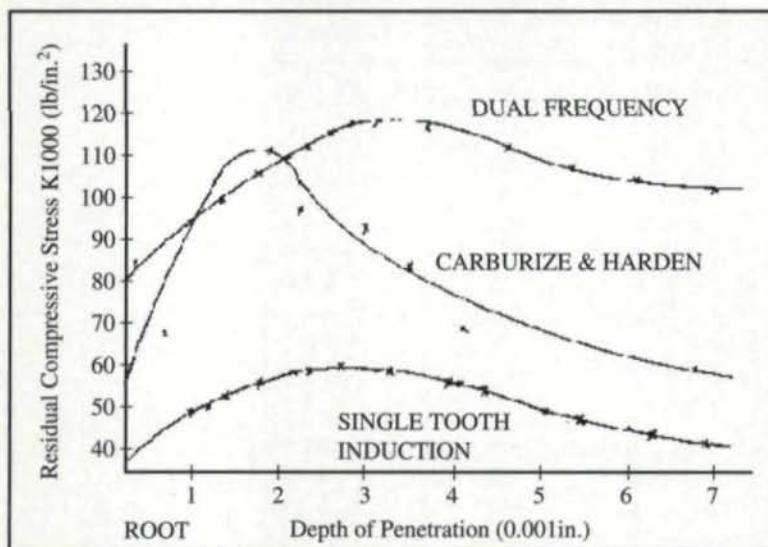

**Fig. 3 - Residual compressive stresses.**

and added processing.

The dual frequency gear hardening process treats the problem by reducing or eliminating the distortion of gear teeth through heating to levels acceptable in most gear final print tolerances. Table III shows the operations required to manufacture gears utilizing three different hardening methods.

To selectively harden gear teeth utilizing the selective carburizing process, they must be handled (load/unload) a minimum of 16 times. In addition to handling the part, numerous inspection and support personnel are needed to maintain plating solution and equipment.

The following physical characteristics were evaluated on six diametral pitch production gears

for the automotive industry:

- Residual stress level
- Microhardness gradient
- Pattern depth of penetration
- Before and after dimensional characteristics

The residual stress evaluation was made on a comparative basis to determine relative root residual stress levels in gears hardened via different methods. Residual compressive stress is favorable because it tends to subtract from an intensity of the tensile stresses during operation of the gear. Residual stress levels were measured by the "Fastress" method to determine root compressive stress. The dual frequency method was found to have 120,000 psi compressive at 1.003 inches. Fig. 3 shows the comparison between the carburize and harden method, single tooth induction, and dual frequency hardening.

Fig. 4 shows the microhardness gradient at three positions across the teeth. Figs 5a and b are gear inspection charts taken from a CNC universal gear checker. They show the "before" and "after" lead, involute, and runout checks.

**Conclusion**

Even in an age of high technology, heat treating of gears leaves much to be desired. Invariably, the imperfections of the process create dimensional distortions, which, in addition to other difficulties, can yield a production "fallout" of 10% to 20% or can lead to rework operations in an effort to salvage the gears.

Until now, industry just had to live with the

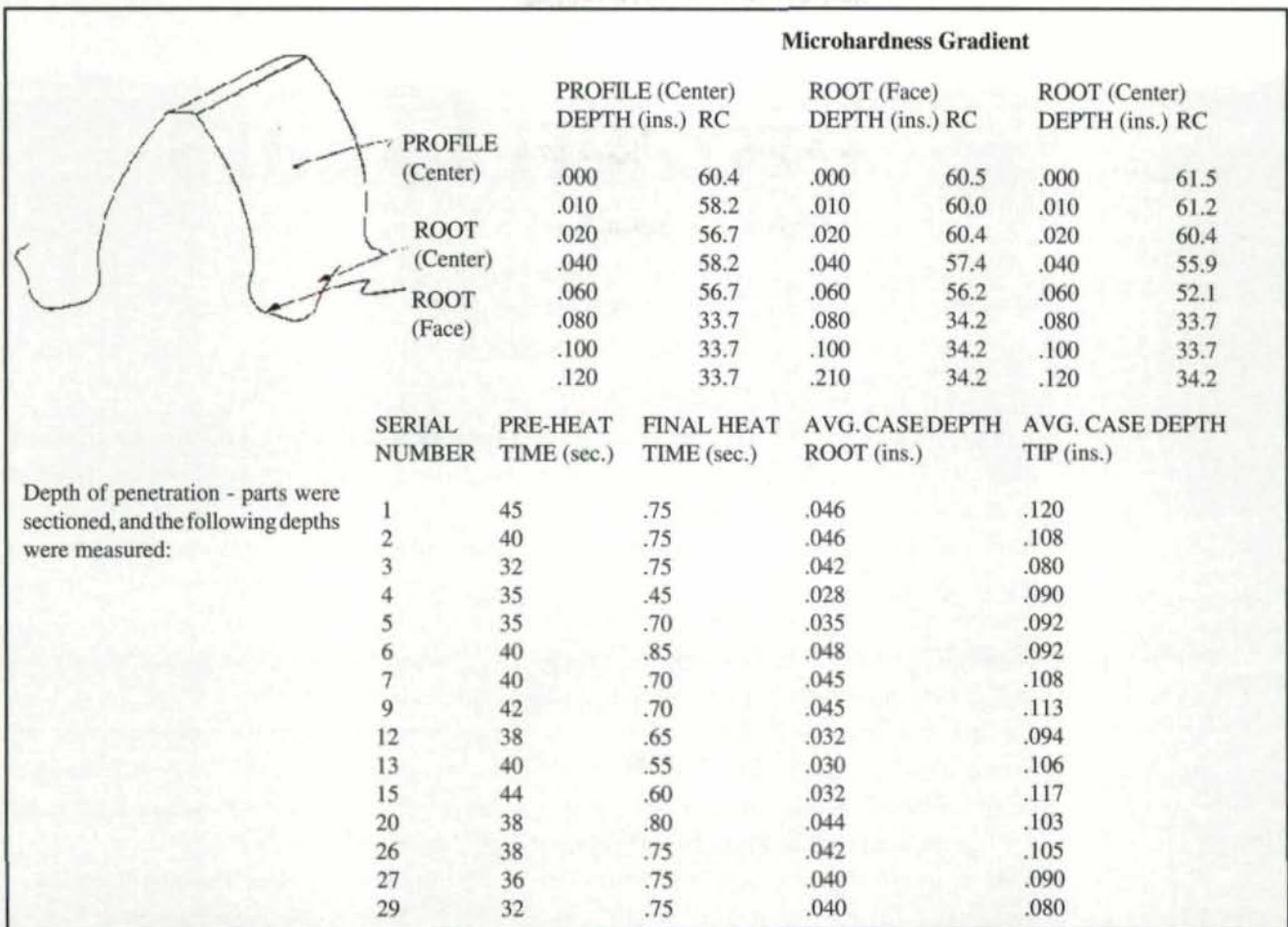

Fig. 4 - Microhardness gradient.

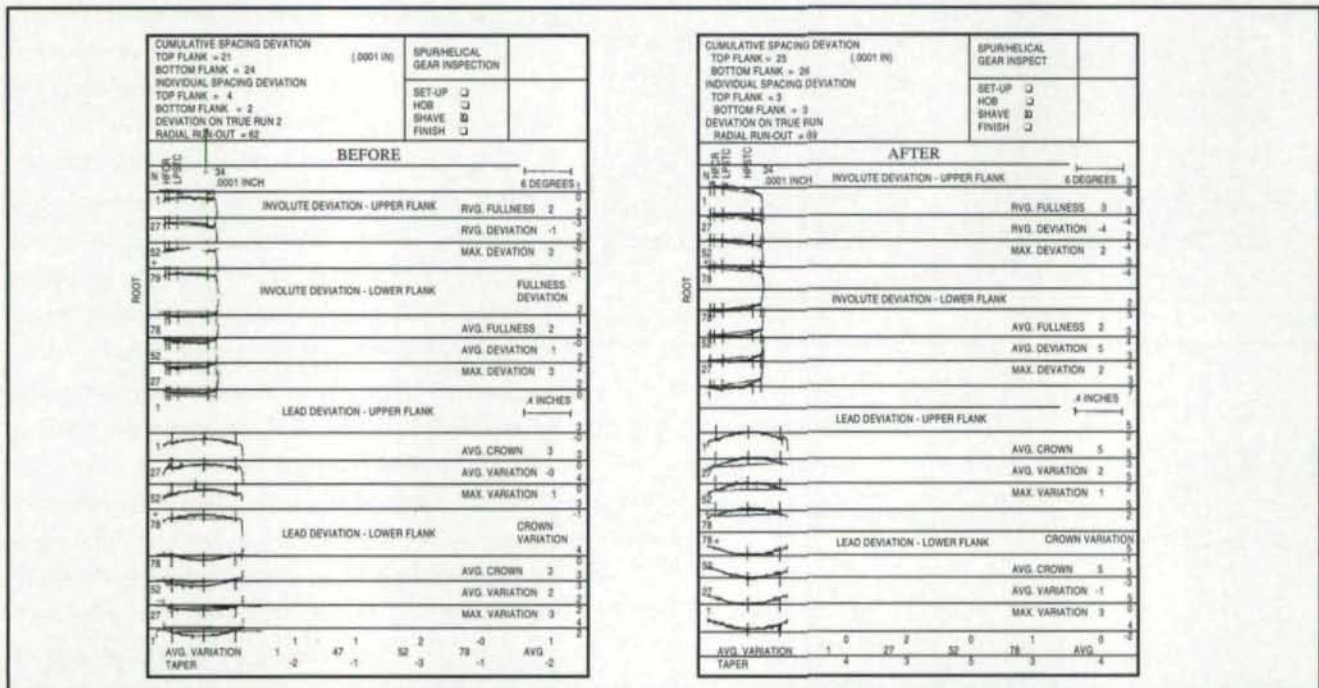

Fig. 5a - Gear inspection chart - "before."

Fig. 5b - Gear inspection chart - "after."

problem. Now a new heat treating system has overcome those traditional limitations, not with untried technology, but with an innovation on established technology. The system provides advanced induction heating with the total, repeatable accuracy of programmable microprocessor control. ■

**Acknowledgement:** Printed with permission of the copyright holder, the American Gear Manufacturers Association, Alexandria, VA. The opinions, statements, and conclusion presented are those of the Authors and in no way represent the position or opinion of the Association.

# Frozen Gears

Pete Paulin  
300° Below, Inc.  
Decatur, IL

Durability is the most important criterion used to define the quality of a gear. The freezing of metals has been acknowledged for almost thirty years as an effective method for increasing durability, or "wear life," and decreasing residual stress in tool steels. The recent field of deep cryogenics (below  $-300^{\circ}\text{F}$ ) has brought us high-temperature superconductors, the superconducting super collider, cryo-biology, and magneto-hydrodynamic drive systems. It has also brought many additional durability benefits to metals.

The deep cryogenic tempering process for gears is an inexpensive, one-time, permanent treatment, affecting the entire part, not just the surface. Gears may be new or used, sharp or dull,

and resharping will not destroy the treatment. The process has a number of obvious benefits, including increases in tensile strength, toughness, and stability through the release of internal stresses. The exceptional increase in wear resistivity, generally exceeding 200%, is the greatest benefit.

Steel surfaces receiving wear, such as gears, shaper cutters, drill bits, end mills, taps, dies, surgical scissors, bearings, racing engines, slicers, and granulator knives, all benefit from this inexpensive treatment. New applications are being discovered regularly.

## Completing the Heat Treating Process - Martensitic Transformation

A research metallurgist at the National Bureau of Standards states, "When carbon precipitates form, the internal stress in the martensite is reduced, which minimizes the susceptibility to microcracking. The wide distribution of very hard, fine carbides from deep cryogenic treatment also increases wear resistance." The study concludes: "... fine carbon carbides and resultant tight lattice structures are precipitated from cryogenic treatment. These particles are responsible for the exceptional wear characteristics imparted by the process, due to a denser molecular structure and resulting larger surface area of contact, reducing friction, heat, and wear."

Metallurgists have been skeptical of the cryogenic process for some time, because it imparts no apparent visible changes to the metal. The thinking is that since proper heat treating changes 85% of the retained austenite to martensite, and the deep cryogenic process only transforms an additional 8 - 15%, deep cryogenic treatment is an inefficient process.

These are correct premises, but an inaccurate conclusion. Deep cryogenically cooled metals also develop a more uniform, refined microstructure with greater density. Microfine carbide "fillers" are formed, which take up the remaining

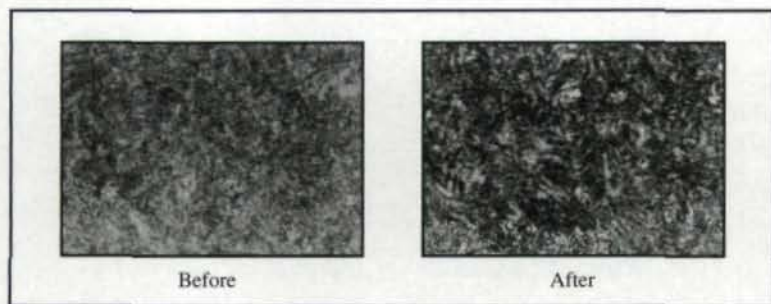

Fig. 1

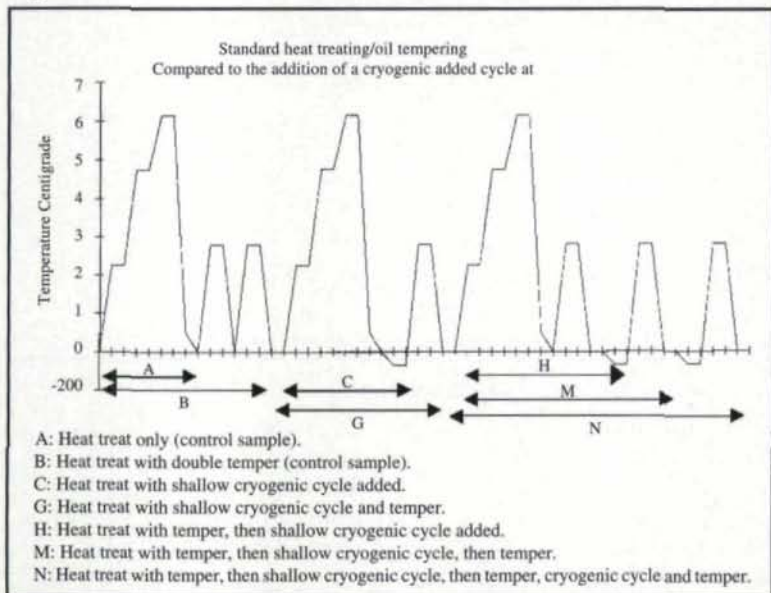

Fig. 2

space in the micro-voids, resulting in a much denser, coherent structure of the tool steel. The end result is increased wear resistance.

These particles are the same ones identified and counted in the accompanying study using a scanning electron microscope with field particle quantification. (An automatic particle counter.) It is now believed that these particles are largely responsible for the great gains in wear resistivity. Unlike the case of coatings, the change created is uniform throughout and will last the life of the tool, regardless of any subsequent finishing operations or regrinds. It is a permanent, irreversible molecular change.

The two 1000X micrographs shown in Fig. 1 represent samples from the same S-7 bar stock. The first is untreated S-7. The second was deep cryogenically treated. The martensitic transformation is readily apparent.

#### **Field Testing Proves Deep Cryogenic Potential**

The cryogenic cycle is an extension of standard heat treatment, and creates many outstanding increases in durability. For example, a major aircraft manufacturer testing deep cryogenics found that with only six different tools treated, the savings in tool purchases could exceed \$5 million.

The deep cryogenic treatment of an 8% cobalt end mill has demonstrated dramatic improvements in two important ways. The number of milling cuts was increased from three before deep cryogenic processing to 78 after processing, 26 times the wear life. Resharpening the end mills after deep cryogenic treatment required only 1/3 the amount of stock removal to restore the tool geometry.

Rockwell, a major aircraft manufacturer running C-2 carbide inserts used to mill epoxy graphite, doubled its output after deep cryogenic treatment. In a second test used to mill 4340 stainless steel, it achieved a 400% improvement.

Other applications include leading national stock car auto racers, who previously raced only 4-8 races between teardowns, went to 40+ races after treating the block, crank, cam, pistons, and heads.

#### **Lab Results Confirm the Field Testing**

The latest research data on cryogenic tempering confirms the long standing theory that cryogenic treatment significantly enhances cutting tool life. Dr. Joan Alexandru and Dr. Constantin

Picos of The Polytechnic Institute of Jassy, Romania, utilized the latest scientific equipment available, a JEOL IXA-5A Electron Probe, a DRON-1 X-ray Diffractometer, a Quantimet 720 Quantitative Microscope, and a Chevenard Differential Dilatometer to supply the following results from the extensive study.

The study involved 7 samples (A-N in Fig. 2), each subjected to a different tempering cycle as noted. Each sample was the equivalent of M2 steel; each sample had the carbide particles physically counted, both before and after the deep cryogenic treatment. The team then measured the samples with the equipment above, and with standard metallurgical evaluative testing. The results confirm with tangible evidence the carbide precipitation in cryogenic processing.

All the metal samples were taken from identical batch stock. The sample structure was comprised of .83%C, .38%Mn, .3%S, 4.1%Cr, 5.1%Mo, 1.92%V, and 6.3%W. Samples were all simultaneously standard heat treated at 1230°C, then oil-quenched. Four of the pieces were then subjected to the cryogenic cycle at -70°C with varying tempers added after cold soaking.

#### **Findings**

The results of the testing conclude with the following findings and analysis comparing standard heat treating to heat treating with the addition of a shallow cryogenic soak:

- Austenite decreased from 42.6% to 0.9%.
- Martensite increased from 66% to 81.7%.
- Carbides increased from 6.9% to 17.4%.
- Mean number of carbides counted @ 1 mm sq. increased from 31,358.17 to 83,529.73.
- Number of carbides less than 1 µm in size increased from 23,410.24 to 69,646.09.
- Rockwell increased from 60.10 to 66.10.
- Tensile strength increased from 86.0 to 244.46.
- Bending strength increased from 86.0 to 244.46.
- KCU (resiliency) increased from 0.668 to 1.18.
- HRC 675°C after 20 minutes keeping: 56.88 to 62.25.
- Durability of the cutting time increased from 20 minutes to 45 minutes with a shallow cryogenic cycle.

Fig. 2 illustrates the seven separate heat/cooled cycles used to temper the lathe cutting tools. The lathe cutting tools were then used to cut a .5%

#### **Pete Paulin**

*is the president of 300° Below, Inc. He has a degree in aeronautical science from Embry-Riddle Aeronautical University, Bunnell, FL. He has published several other articles on cryogenic research.*

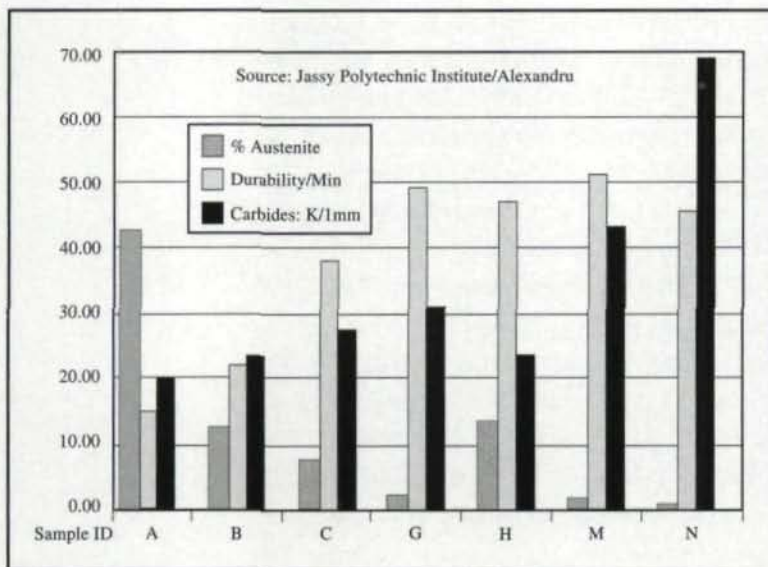

Fig. 3

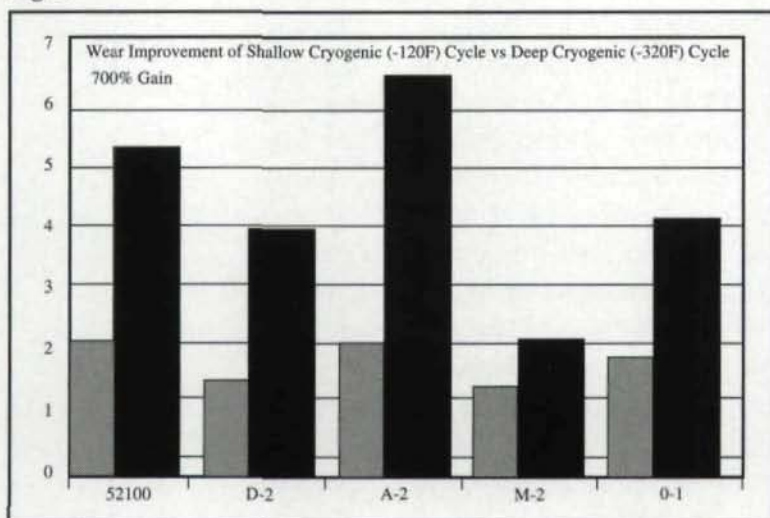

Fig. 4

Table 1  
TEST RESULTS: Percent of Increase in  
Wear Resistance After Cryogenic Tempering

Materials that showed significant Improvement			
AISI#	Description	At -110°F	At -310°F
D-2	High carbon/chromium die steel	316%	817%
S-7	Silicon tool steel	241%	503%
52100	Standard steel	195%	420%
0-1	Oil hardening cold work die steel	221%	418%
A-10	Graphite tool steel	230%	264%
M-1	Molybdenum high-speed steel	145%	225%
H-13	Chromium/moly hot die steel	164%	209%
M-2	Tungsten/moly high-speed steel	117%	203%
T-1	Tungsten high-speed tool steel	141%	176%
CPM-10V	Alloy steel	94%	131%
P-20	Mold steel	123%	130%
440	Martensitic stainless	128%	121%
Materials that did not show significant improvement.			
430	Ferritic stainless	116%	119%
303	Austenitic stainless	105%	110%
8620	Nickel-chromium-moly alloy steel	112%	104%
C-1020	Carbon steel	97%	98%
AQS	Graphitic cast iron	96%	97%
T-2	Tungsten high-speed steel	72%	92%

R. F. Barron study results. Louisiana Polytechnic Institute.

structural carbon steel. Durability was established by measuring the radial component of wear. Intensive Speed: @33.6m/min.; Depth: 5mm; Feed: 0.62mm per rev. Relief angle: 8°; Hake angle: 5°; Plan angle: 45°.

### Deep Cryogenic Cycle Doubles the Results of the Shallow Cryogenic Cycle

Separate laboratory testing has been performed by Dr. Randall F. Barron at Louisiana Tech University, Ruston, LA. The results by Dr. Barron confirm the Jassy study even further. In one series of tests Dr. Barron compared five common steel alloys. First he tested them as procured. Then he chilled them to -120°F, tested them again, and then treated them at -317°F. In all cases the cold treatment improved wear resistance. The colder the treatment, the better. The -120°F (dry ice) treatment improved ratios ranging from 1.2 to 2 times, depending on the alloy. This is consistent with the Jassy findings. However, the deep cryogenic treatment at 317°F improved wear resistance by even greater ratios ranging from 20 to 6.6 times.

### Process Developments

The deep cryogenic process has had an Achilles heel. It has been inconsistent. In the past, improvements to gears would vary from little improvement to over a 1,000% increase in useful life. The trick is in the processing. Temperature changes must be controlled exactly for consistent results. If a gear or tool is dropped in liquid nitrogen, it could shatter.

The computer processor solves this problem. The computer can duplicate the optimal cooling curve exactly time after time after time.

Older cryogenic tanks did not have adequate control. Using them was like trying to bake a cake in a wood-fired stove. The newest cryogenic tempering systems achieve consistent results. Furthermore, the price enables the gear manufacturer to improve his profit margin, improve his product, and increase market share with a superior product.

### The Cryogenic Tempering Process

The new machines operate with controlled dry thermal treatment. "Controlled" simply means that the process is performed according to a precise prescribed time table. A 386 PC is utilized as the process controller operating the descent, soak, and ascent modes. The material is cooled slowly to -317°F, held for 20-60 hours, then raised to +375°F, and slowly

returned to room temperature. It is a "dry" process in that, unlike other deep cryogenic processes, it does not bathe the materials in liquid nitrogen, which is more likely to cause damage from thermal shock.

#### **How It Works**

The Barron study looked at how the changes brought about by cryogenic treatment affected steel's ability to resist abrasive wear. It found that the martensite and fine carbide formed by deep cryogenic treatment work together to reduce abrasive wear. The fine carbide particles support the martensite matrix, making it less likely that lumps will be dug out of the cutting tool material during a cutting operation and cause abrasion. When a hard asperity or foreign particle is pressed onto the tool's surface, the carbides further resist wear by preventing the particle from plowing into the surface.

Some of these benefits may be achieved through standard tempering, which also transforms austenite into martensite. But standard tempering may not bring about a complete transformation in some tool steels. For example, 8.5% of an O-1 steel remains austenite after it is oil-quenched to 68°F. If M-1 is quenched from 222°F to 212°F, then tempered at 1049°F, the retained austenite is 11%.

Additional improvements in tool performance can be achieved if this retained austenite can be transformed to martensite. As Barron's study has confirmed, adding a cryogenic step to the treatment process does just that.

In Table I, data drawn from another study of treated metals by Barron indicates which samples exhibited improved abrasive wear after cryogenic treatment. In addition to results obtained from samples treated at liquid-nitrogen temperature (-310°F), the chart also lists results of treatment at dry-ice temperature (-110°F).

#### **How Effective Is It?**

Knowing how deep cryogenic tempering works, we can predict which materials will benefit most from treatment. Generally, if an alloy contains austenite, and this austenite responds in some degree to heat treatment, further improvements will be seen after deep cryogenic tempering. For instance, ferritic and austenitic (430 and 303) stainless steels generally cannot be hardened by heat treatment. Martensitic (440) stainless steels, on the other hand, can be hardened by heat treatment; therefore, the effect of deep cryogenic treatment

should be more pronounced for 440 stainless steel than for the other stainless steels.

C-1020 carbon steel and QS Meehanite iron also show no significant improvements in performance after cryogenic treatment. Because these materials contain no austenite, sub-zero temperatures can cause no further metallurgical changes in them.

#### **Financial Potential**

Liquid nitrogen is the largest processing cost in cryogenically cooling gears. The newest systems are designed to more efficiently transfer cold from the liquid nitrogen to the metal parts being treated without losing the cold to the outside. They have reduced processing costs by half, making it economical to process all types of steel items, not just gears and tooling. Gears now cost pennies instead of dollars to treat with this method.

Potentially every gear which is heat treated is a candidate for the additional service of cryogenic tempering. Most customers are pleased to pay for the additional improvement of any gear, especially at a nominal additional cost (less than \$1 per pound!).

There are more than a handful of large tooling manufacturers quietly utilizing the process today for manufacturing a premium line of cutting tools. They manufacture a "premium" tool which lasts 2-5 times longer for pennies and charge dollars more for it - a great boost in a competitive market place where profit margins have been squeezed.

Some heat treaters offer "cold cryogenic services" utilizing -120°F (dry ice) systems, but deep cryogenic treatment (below -300°F) is where most of the benefits occur. Ultra low temperature treatments below -300°F show much more impressive results.

#### **Conclusion**

While not a magic wand which will extend the life of every product, over 100 items, such as gears, reamers, taps, dies, broaches, drills, endmills, slicers, and cutting knives do respond to the process. It can create a "premium" more profitable tool gear for a manufacturer and save a lot of tool expense dollars for end users. The process is effective throughout the tool, unlike a coating, so tools can be resharpened and receive the benefits until completely worn out. The process also works with TiN coatings.

Among the properties which define the qualities of a gear steel, durability is the highest importance. These results are decisive in establishing the benefits of cryogenic treatment in increasing durability. ■

# Improving Gear Manufacturing Quality With Surface Texture Measurement

**Mike Moyer**  
**Rank Taylor Hobson, Inc.**  
**Des Plaines, IL**

The working surfaces of gear teeth are often the result of several machining operations. The surface texture imparted by the manufacturing process affects many of the gear's functional characteristics. To ensure proper operation of the final assembly, a gear's surface texture characteristics, such as waviness and roughness, can be evaluated with modern metrology instruments.

## What is Surface Texture?

Simply stated, the surface texture of a gear tooth is the surface that is the result of the manufacturing process. In machined gears, surface texture is the result of the tool passing over the tooth; in molded or cast gears, it is the combined result of the material, mold, and molding process.

In more technical terms, the manufactured surface can be defined by three general measurement categories: roughness, waviness, and form.

On today's sophisticated metrological devices, these categories are evaluated by their wavelengths. The short wavelengths of roughness are caused by fracturing, cutting, grinding, or honing. The medium wavelengths of waviness represent short term machine errors, such as a single aberrant revolution of a spindle, while long wavelengths of form are the result of tool path errors, such as straightness.

The process of measuring and analyzing surface finish is called "surface texture metrology." When the technology of metrology is applied to gear manufacturing, the engineer has a powerful tool to assist the analysis of a gear's ability to retain lubrication, distribute force, run quietly, and withstand wear, all of which may be related to surface texture. Lubrication, for instance, is retained in the valleys that have been created on the surface. On the working surface, stress is increased by the presence of robust peaks and deep valleys. Noisy operation may be the result of waviness and chatter, and wear may be attributed to many causes, such as the lack of a load-bearing area.

## How is Surface Texture Measured?

With the proper surface metrology equipment, common gear problems can be discovered before a gear goes into the final assembly. Currently, there are two basic categories of instruments used to evaluate surface texture: a) the simple roughness average instrument, and b) the more sophisticated engineering quality instrument.

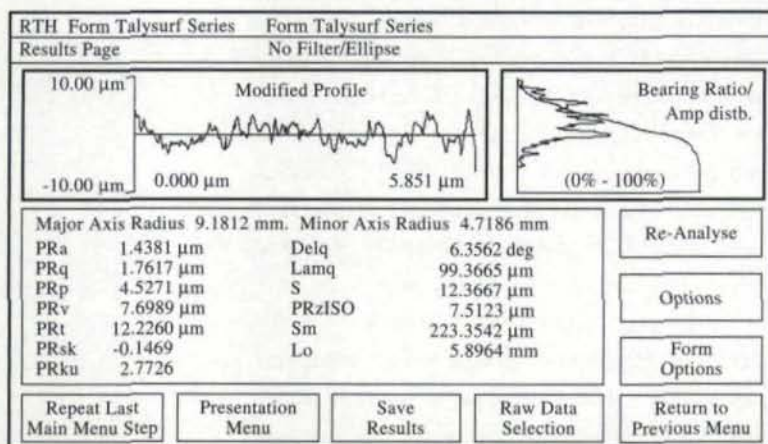

Fig. 1



Standard averaging instruments are low-cost devices that are commonly found on the shop floor. Because they lack the sophisticated technology required to measure complex forms and present multiple parameters, these instruments are capable only of the limited evaluation of a straight surface.

On the other hand, the engineering quality device is capable of detailed analysis of surface texture parameters, waviness parameters, radial size, and straightness. These instruments are generally found in the laboratory or inspection area, but smaller and more durable versions of this instrument are now available for use at the point of manufacture.

### **Recent Technological Advances in Metrology Instruments**

The technological evolution from the averaging instrument to the engineering quality device is a giant leap in metrology. In fact, it can be said that the difference between the two is akin to the difference between superstition and science. A quick glance at the disparity between these two machines will make this difference immediately apparent.

The engineering quality instrument features a high resolution, wide range transducer to a) ease setup, b) permit operation with a range of surface forms, and c) offer improved accuracy by eliminating skids. Transducers with dynamic ranges of .04" make it easier for the user to stage the part being inspected. Accurate readings can be obtained when the traverse is not perfectly parallel with the surface to be measured. For the highly sophisticated user, a transducer with .24" range and .0000004" resolution is available. This transducer is frequently used to measure the size of circular shapes.

And the latest advances in transducers have led to the elimination of skids. Although they eased setup by establishing a local datum, skids also contributed to system error.

Two-axis coordinate measuring machine principles improve the metrology technique. The modern engineering instrument is a true two-axis coordinate measuring machine with extremely high resolution and very good straightness on travel. The high number of data points collected describe the surface with extremely high fidelity.

Digital electronics eliminate analog filters and improve stability. Because the metrology equipment now works with numbers rather than analog voltages, a computer is used to mathematically filter the results. This technique greatly improves accuracy and permits the use of filters

with less distortion. The benefit is simple: more accurate measurement.

Today's instrument offers high-resolution display of results. Gone forever are strip chart recorders with their poor frequency response and balky operation. For highly accurate and readable displays, the most recently developed metrology equipment takes advantage of VGA graphics and high-resolution printers.

Mathematic removal of the circular form allows improved accuracy. Form removal techniques ensure accurate results on curved surfaces. The computer permits the quick and easy removal of mathematically defined and empirical forms. Once the form is removed, the texture is evaluated as if it were on a straight surface, providing improved accuracy while allowing easier analysis.

More advanced instruments also provide a wide range of analysis in the form of numeric parameters. With today's metrology equipment, the engineer has a wide selection of parameters from which to choose. These are the tools engineers depend on to numerically define an acceptable surface. Commonly used parameters include:

- Averaging parameters: Ra, Rq, Rpm, Rz (DIN).
- Waviness parameters: Wa, Wq, Wz (DIN).
- Peak parameters: Rp, Rv, Rti, Rt, Ry, Wp, Wv, Wt, Wti, Wy.
- Hybrid parameters: skew, kurtosis
- Amplitude distribution and bearing ratio (Abbott, Firestone) curve interpreters: Rk, Vo, Tp, Pc, HSC, Htp.

### **How Surface Texture Metrology Fits Into The Design and Manufacturing Process**

When initiating a new design, a product engineer must choose the surface parameter which controls the features important to the function of the finished product. This is the description that is put on the print for the finished product. Only then can the appropriate metrology instrument and procedure be selected.

The manufacturing engineer's task differs from that of the design engineer. The manufacturing engineer is concerned not only with the finished part, but also with the part in process. If a gear is to be hobbled, ground, and honed, a prudent engineer knows he will need to control the surface texture at each stage to minimize cost and assure final quality. For example, if we can assure a consistent surface texture range from the hob, we can control the grinding operation to minimize

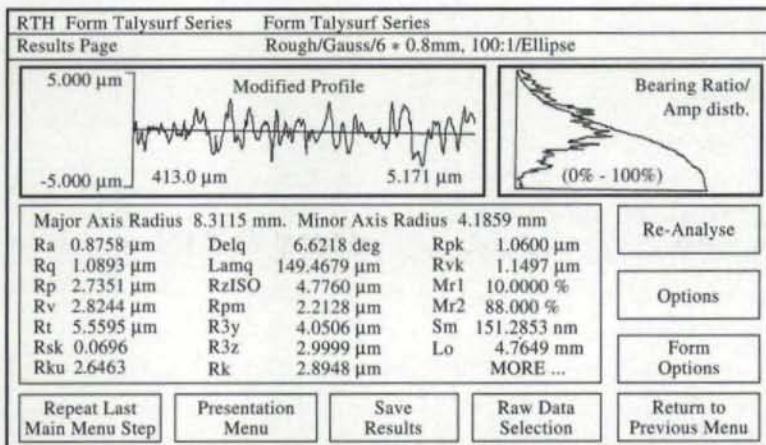

Fig. 2

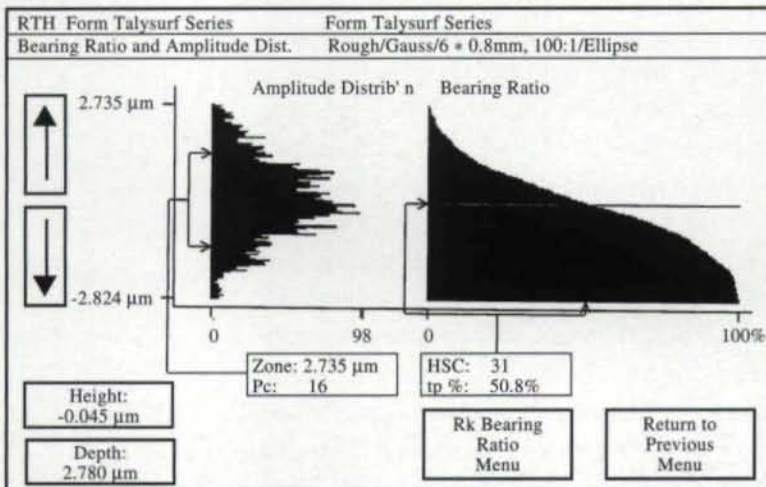

Fig. 3

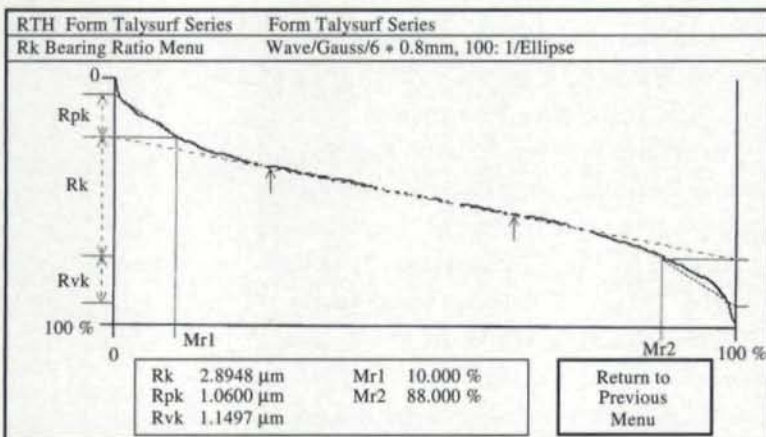

Fig. 4

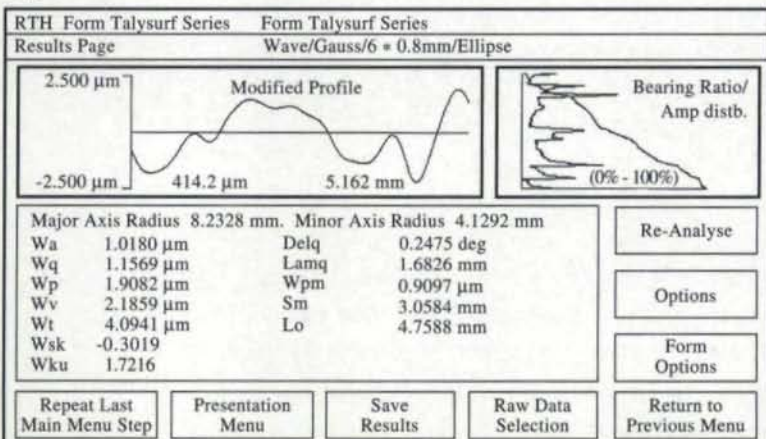

Fig. 5

cutting depths, reducing heat and distortion. A consistent grinding finish means we can predetermine the honing cycle time.

### Case Studies

Let's turn to some practical examples. These charts are readings taken from a finished gear with an engineering-quality metrology instrument. Raw data from the surface of a gear tooth was taken from the root out.

Fig. 1. The surface with the circular form removed. The result combines roughness and waviness. The data was acquired with a diamond tipped stylus having a 0.00008" radius.

Fig. 2. The result of low distortion filtering to remove the long wavelengths of waviness. The commonly used parameters are calculated.

Fig. 3. This is an examination of the amplitude distribution and the bearing ratio curves. Here is where we will find the description of multi-processed surfaces. Both of these analyses are a summary of the surface examined. Amplitude distribution is the number of events vs. height from the top of the trace to the bottom. This analysis could be used to limit the number of peaks or valleys at a specific amplitude. Bearing ratio is the length of the surface vs. height expressed as a percentage. This analysis could be used to limit the width of the peaks or mandate the width of the valley indirectly controlling their volume.

Fig. 4. This figure shows the Rk parameter with an evaluation of the bearing ratio curve. This analysis was developed to characterize the multi-processed surface of the cylinder bore of an internal combustion engine. A similar approach may be applicable to gears. The parameter is used to control the amount of debris during breaking, the height of the core load bearing surface, and the ability to retain lubrication. Note that each area of interest is described numerically.

Fig. 5. This chart shows the analysis of the low frequencies of waviness. The significant parameters have been calculated.

Our discussion has concerned the metrological needs of the manufacturing process and its control. The investigative scientist may use other analysis procedures to evaluate subjects of interest. These may include the effect of peak height vs. lubrication thickness or peak area vs. stress. The modern surface texture measuring instrument is a versatile engineering device for roughness, waviness, form, and size, and because of its power and precision, it is applicable to more scientific studies as well. ■

# Evolution. . . .



See Us At



Booth 3146

## of Spline Gaging.

3500 BC - Man invents the wheel and says "it is good"  
2500 BC - Man invents the spline and says "it is good"  
2499 BC - Man invents the spline gage and says "it'll do the trick"  
Man has been using the same spline gage ever since. That is, until FRENCO redesigned the gage for modern man. The Frenco indicating spline gage produces variable data on exact Pitch Diameter while simultaneously checking "GO" condition. This SPC compatible gage also quickly checks taper, ovality and other time consuming inspections. Available for internal, external, straight or involute spline configurations.



Let us show you a system for today and beyond. Call or write:

**guehring**  
AUTOMATION INC

W227 N6193 Sussex Road  
P.O. Box 125 • Sussex, WI 53089  
(414)246-4994 • FAX (414)246-8623



CIRCLE A-8 on READER REPLY CARD

## Deburring Solutions from

# James ENGINEERING

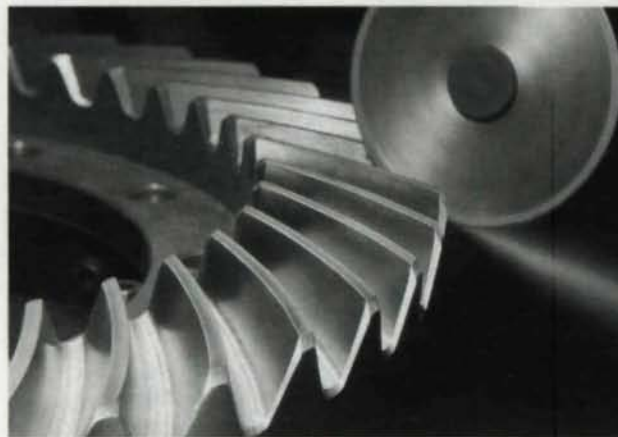

- Modular design allows flexible customizing
- Compact size is ideal for cell environments
- Quick easy setups make short runs practical
- Substantial productivity improvements over conventional methods
- Reduction of scrap rates
- Automated part handling systems available
- Attachment options for all gear configurations
- Systems for irregular part shapes
- Dust control enclosures
- MIL Spec deburring control

The James Engineering modular deburring systems can be set up in less than one minute, with cycle times of 20 to 50 seconds per part. Manual loading and unloading barely takes 5 seconds, with fully automated systems available. Precision controls allow edge break of uniform quality and consistency from part to part and from .001" radius to large chamfers. Modular design allows modification of system as needs change. Due to the compact size, the system may be placed near hobs or shaper cutters, allowing operators to deburr the gear while demanding very little of their time or attention. This allows shops to either eliminate or drastically reduce secondary handling and conventional deburring steps. This significant reduction in labor, along with a lower scrap rate, means big dollar savings to the user.

James Engineering • 4732 Pearl Street • Boulder, CO 80301 • (303) 444-6337 • Fax (303) 444-6561

CIRCLE A-9 on READER REPLY CARD



# Introduction to Worm Gearing

James K. Simonelli  
 JKS & Associates,  
 Brecksville, OH

Worm gears are among the oldest types of gearing, but that does not mean they are obsolete, antiquated technology. The main reasons for the bad experiences some engineers have with worm gearing are misapplication and misuse. No form of gearing works for every application. Strengths and weaknesses versus the application must be weighed to decide which form of gearing to use. For proper application and operation of worm gears, certain areas that may differ from other types of gearing need to be addressed.

### The Basics

Worm gear reducers are quiet, compact, and can have large reduction ratios in a single stage. The ideal ratio range for worm gearing is 5:1 to 75:1. This is the general range for most catalog reducers. Ratios of 3:1 to 120:1 are practical and have applications that are very successful. For ratios below 3:1, worm gearing is not a practical solu-

tion for most applications, and other forms of gearing should be considered. Worm gearing for ratios above the ranges mentioned are generally more practical as part of a multi-stage reduction.

In service, worm gears survive large overloads and high shocks. When properly applied, worm gearing can offer excellent performance and cost savings. Worm gearing has an inherent 200% overload (i.e., 3x rating) capacity in its rating. Other forms of gearing do not have this built-in service factor. Therefore when sizing a worm gear set, a lower service factor than normal can be used.

### Explanation of Hand

The purpose of left- and right-hand gearing is to change the relative rotation of the worm to the gear. Hand refers to the direction of axial thread movement as the worm is rotated. If you point your thumb in the direction of axial movement and curl your fingers in the direction of

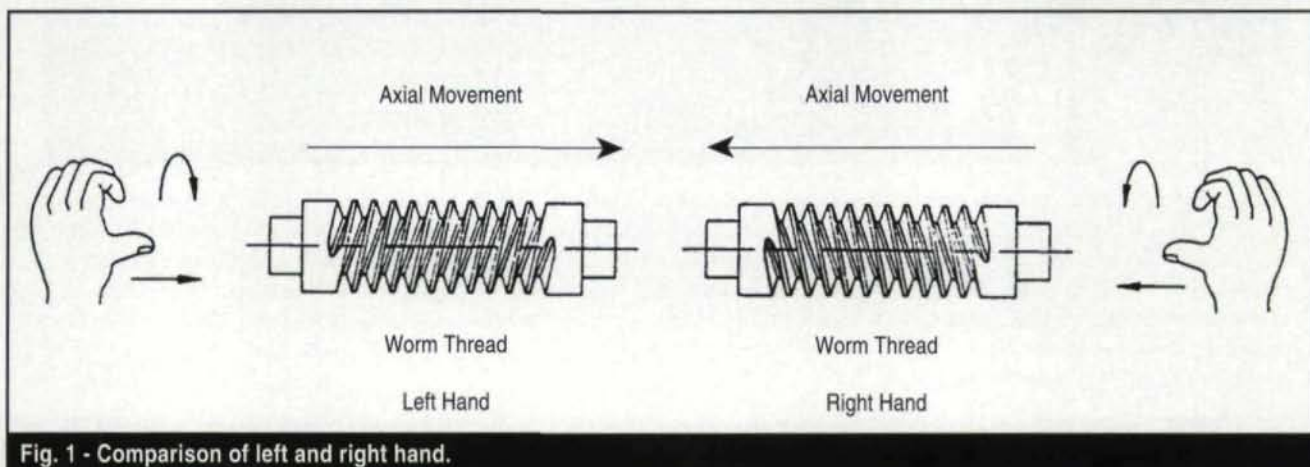

Fig. 1 - Comparison of left and right hand.

rotation, the hand that corresponds to the worm is the hand of the gear set. (See Figs. 1&2.) Bolts are a simple example. Normally they are right-handed, and experimenting with a nut and bolt will help to clarify this description.

Right-hand gear sets, like bolts, are the industry standard. More right-hand gear ratios are available as standard items, and most manufacturers will supply right-hand gearing unless otherwise specified. This does not mean there is a flaw in left-hand gearing, but left-hand ratios may not be as readily available.

### Back Driving

Running a worm gear set with the gear (worm wheel) as the input member is commonly called *back driving*. Back drive efficiency of a worm gear set is lower than its forward drive efficiency. By varying design, the back drive efficiency can be reduced to zero, as in a *self-locking* or *irreversible* gear set. If the gear tries to drive the worm, internal friction causes the mesh to lock. No matter how much torque is applied to the gear shaft, mesh friction increases proportionally, preventing rotation. This is the same principle that keeps a nut and bolt from unscrewing under an applied tension load.

Back driving can occur in many applications. A worm gear speed increaser is the most obvious, but it is rarely used because of its low efficiency. It also occurs in lifting applications, such as cranes, hoists, and crank arms. When lowering the load, the gear is the input member. Worm rotation controls the rate of descent. Also, during braking or coast-down, the momentum of a device will back drive a worm.

A self-locking worm gear can be designed by making the lead angle less than the *friction angle*, which is defined as the arc tangent of the coefficient of friction. The static coefficient of friction is .20 to .15, equating to a friction angle of 11.3° to 8.5°. Vibration in a non-rotating gear set can induce motion in the tooth contact. The mesh velocity is zero, but the tooth contact is dynamic. At a mesh velocity of zero, the theoretical dynamic coefficient of friction is .124, or a friction angle of 7.0°. To provide a safety factor, a 5.0° lead angle is recommended as the upper limit of self-locking, and a 15.0° lead angle is recommended as the lower limit to assume a worm

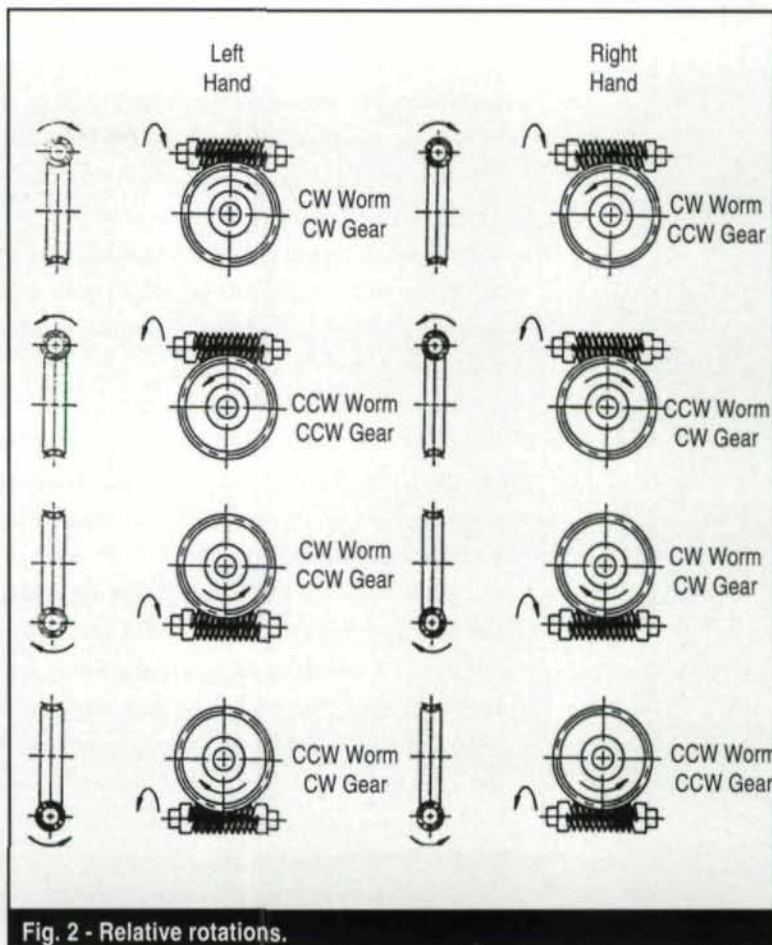

Fig. 2 - Relative rotations.

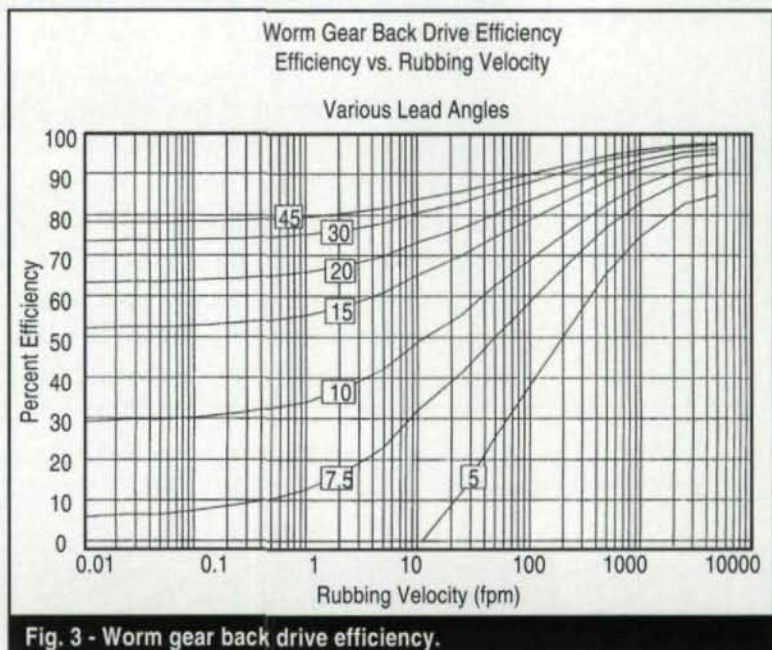

Fig. 3 - Worm gear back drive efficiency.

gear will back drive.

Back drive efficiency decreases with decreasing speed. The slope of this curve is exponential and is affected by the lead angle. (See Fig. 3.) This factor should be considered when sizing a brake and its rate of application. Often a brake placed on the worm can be smaller than normally anticipated. Self-locking worm gear

**James K. Simonelli, P. E.**, is a power transmission consultant. He has over ten years' experience in product design and troubleshooting with applications ranging from small consumer appliances to large steel mill drives.

sets will coast because of dynamic effects.

Using a brake on self-locking designs must be thoroughly analyzed. Most brakes have an increasing torque rate when applied. Also, the efficiency will be decreasing during slow down. This double effect can cause the effective braking torque to rise at a surprising rate, causing a sudden stop. High inertial loads with self-locking designs should have controlled motor speed ramp down for braking.

On the other hand, back drive efficiency increases with increasing speed. Therefore a constant back driving torque restrained only by a worm gear will have a rate of acceleration that increases exponentially. This is a very important point to remember when designing hoists. Unless it is properly designed, relying solely on self-locking mechanism to suspend a load may be dangerous. The load may stay suspended until an outside influence starts a vibration in the gear mesh. At first, the load will creep slowly. As it falls, it accelerates at an exponentially increasing rate.

Since many factors influence the coefficient of friction, gear set designs should be tested for their back drive suitability. Break-in of a gear set will reduce the coefficient of friction. This may make a gear set self-locking when it is new and not self-locking after use. Also, synthetic lubricants can have an effect on the coefficient of friction and may be used in the field without the knowledge of the gear designer.

If self-locking is critical to safety, a brake or "back stop" should be used. A back stop is a clutch device that permits rotation in one direction only. It is sometimes referred to as a "Sprag"

or "roller" clutch and is commonly used on conveyors that lift material to prevent reversal if power is lost.

"Plugging" is a method of braking generally used in large crane wheel drives that use reversal of the drive motor. Plugging applications can cause extremely high torque spikes. The worm system inertia consists of the worm, drive motor, and any miscellaneous components. The gear system inertia consists of the gear and the entire braked device. When plugging, the worm can reverse rotation before the drive train loads in the back drive direction. The worm system's momentum is in a direction opposite the gear system. At impact, the worm must again reverse rotation to follow the gear, crossing a point where the mesh rubbing velocity is zero. The gear system's momentum will generate whatever torque spike is required to force the worm to reverse rotation and overcome the motor plugging torque and the mesh back drive efficiency at zero speed.

Torque spikes are a transient impact effect and not a problem when the system is properly designed. Plugging designs should limit the use of brittle materials, such as grey cast iron. Bolted joints and drive train mountings should be designed for impact. In wheel drives, the wheel slip torque limits torque spike and can be used as a maximum design point. Peak torque can be reduced by slowing the rate of reversal.

#### Contact Pattern

The area of contact the worm makes on the gear as it rotates into mesh is the *contact pattern*. The ideal contact pattern for worm gearing uses 90% of the full face, with the remain-

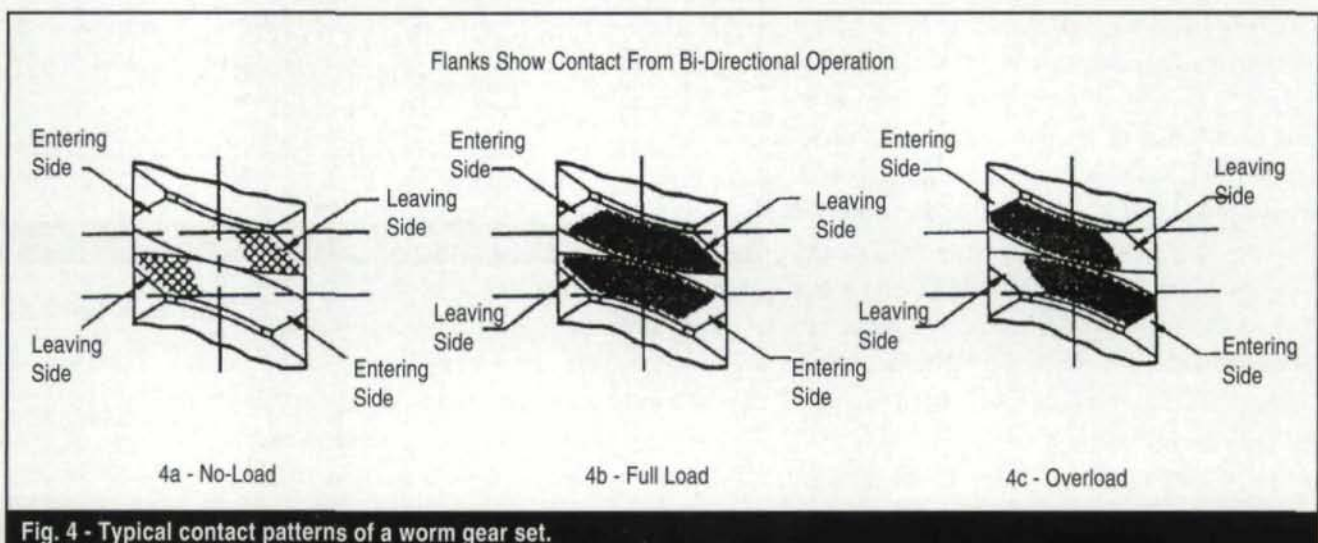

Fig. 4 - Typical contact patterns of a worm gear set.

ing 10% open on the entering side (Fig. 4b). This has maximum area for load distribution and still allows oil to be dragged in for lubrication. If the entering side has contact, (Fig. 4c) the oil would be wiped off the worm as it rotates into the gear. Without oil being drawn in, the gear set will not generate an oil film and will quickly fail. (See the section on lubrication for more details.)

Under load the gearbox, worm, and gear will deflect. These deflections cause the contact pattern to spread across the gear face toward the entering side. To compensate for contact pattern spread, the gear can be moved axially in relationship to the worm. This will increase the open face at no load (Fig. 4a), so as not to close off the entering side at full load. A no-load pattern of approximately 30% of full face on the leaving side is desirable.

Since deflections occur in opposite directions for opposite rotations, the two flanks of a gear tooth cannot be directly in line. The flanks need to be shifted axially with respect to each other when the gear is cut. The axial movement of the gear required for the contact pattern to go from 90% full face to 90% full face on the opposite tooth flank is the *total shift*. Total shift anticipates deflections that will occur from full load forward to full load reverse.

The no-load contact pattern is determined by lightly coating the worm threads with Prussian Blue (i.e., high spot blue). This transfers to the gear teeth when rotated by hand. Although not required, coating the gear teeth with a mixture of powdered orange paint pigment and grease makes the pattern easier to see. The orange grease paint improves the contrast of the blue transfer pattern and adds lubricant to the mesh. To observe the contact pattern under loaded conditions, a coat of layout blue can be sprayed on the gear teeth. This will quickly wear off, revealing the full load contact pattern. Be sure the surface is oil-free when spraying and wait until the blue dries before operation. Oil may wash the coating off if it is not completely dry.

In severe applications under heavy loads, the fully loaded pattern should be checked. The amount of shift cut into a gear may not compensate for an overly flexible housing or higher-than-anticipated loads. For one direc-

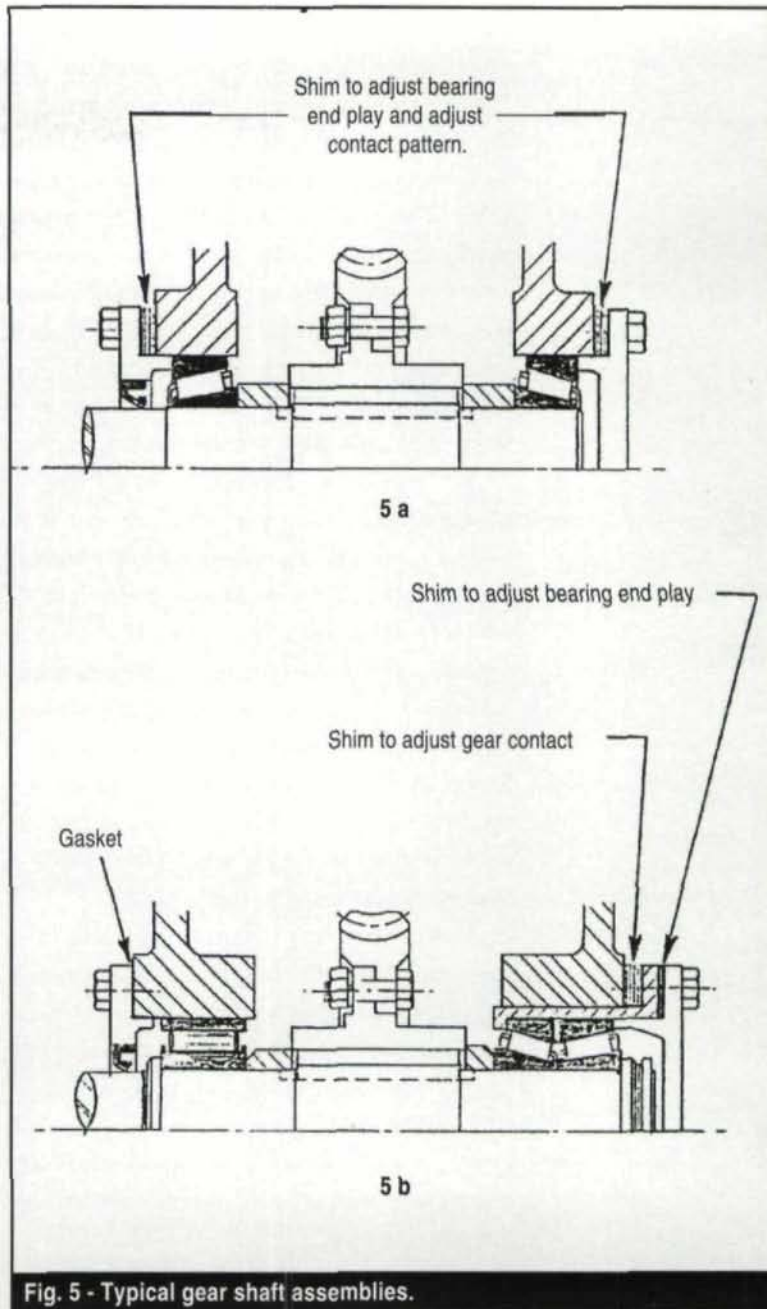

Fig. 5 - Typical gear shaft assemblies.

tion loading, such as hoists or conveyers, shift-cut into a gear is not a major concern. Since the opposite flank is never loaded, the pattern is adjusted on the drive flank only, ignoring the non-drive flank. When adjusting the gear to favor one flank, care must be taken so that the gear does not lose all of its backlash. If this happens, the worm is wedged into the corner of the gear. This will generate excessive heat and cause premature failure.

In most reducer designs, axial gear adjustment is accomplished by shims placed between the gear shaft bearing caps and the housing (Fig. 5a). First, determine the total shim stock for proper bearing end play. Then transfer shims from one side to the other until an optimum

pattern is obtained. In heavy duty applications where one would like to adjust the gear fully loaded, moving shims requires disconnecting the shaft couplings, removing the gearbox from its mounting, and removing the gear shaft coupling. This is a very difficult process in large machinery. A common method to adjust the gear from one side is to put both thrust bearings in a carrier on one side (Fig. 5b). The opposite side is supported by a radial bearing that is free to move axially. There are other methods of adjustment, but these are the most common.

### **Pitting**

Gear tooth pitting results from the combination of several forces. Normal force (referring to a direction  $90^\circ$  to the tooth surface) at the contact point produces Hertzian stress. Friction produces a tangential force, which induces subsurface shear stress. Friction also generates heat. Temperature at the contact point is much higher than the surrounding area. Differential thermal expansion (the phenomenon that can cause a glass to break when a hot liquid is poured into it) induces stress.

Constant cycling as the tooth goes through the mesh can cause a surface fatigue crack. Oil in the gear mesh is under extreme pressure from contact forces. The oil is forced into the fatigue crack, and hydrostatic pressure tries to lift a piece out. Continuing cycles cause the crack to encircle the high stress area. The crack grows deeper, until a piece literally pops out, leaving a pit.

In most gearing, a pitted tooth surface signals impending failure. For worm gearing, pitting is part of normal operation. Corrective pitting is a break-in process. In manufacturing a worm, the thread is generated by a continuous line that can be described by the grinding wheel. It produces a continuous (i.e., smooth and uniform) surface curved in all three planes. The gear is hobbled by a gashed cutting tool that is in effect a worm having a discontinuous or interrupted surface. It produces gear teeth which have a series of short flats or discontinuous surfaces that approximate the desired tooth form. Because of the flats, the gear tooth form is imperfect. Where two flats join there must be a peak. At such a point, the contact stress would be infinite if deformation did not occur.

The break-in process is the gear tooth form being improved by the worm. This is done by elastic or inelastic deformation, wearing away the high spots or pitting them away. After the many high spots are either worn or pitted away, the worm rides on the larger flat areas. The pit areas retain pools of oil, which help support the load by hydrostatic pressure and aid in lubrication. Corrective pitting ceases after a sufficient area has been developed to sustain the load and normal wear takes over. A new worm gear will pit at an alarming rate, then quickly stop. No additional pitting will occur for a long time. Then the surface will again pit rapidly and quickly stop, the cycle recurring throughout the life of the gear.

Destructive pitting is a case of the gear not being able to correct itself enough to support the imposed load. It is the result of overload, improper gear adjustment, improper tooth profile, or improper lubrication. In this case, pitting continues until the gear tooth surfaces are completely destroyed. This is not a common problem, because most errors large enough to cause failure will normally show up as the gearbox overheating.

### **Materials**

Worm gearing has a high sliding component in its tooth meshing action. Sliding contact materials are selected to make one member hard and strong and the other soft and ductile. Friction is generally proportional to the combined hardness of the mating surfaces. Two hard surface cannot deform to broaden the contact area and distribute the contact stress. By hardening only one part and having the other ductile, the combined hardness is increased, while still being able to distribute stress. Also, using dissimilar hardness reduces the chance for galling. Steel and bronze have been the materials of choice because they balance strength, ductility, lubricity, and heat dissipation. Shaft bushings are common examples of sliding components using this arrangement.

The worm is the hard member, and the gear is the ductile member. There are several reasons for this arrangement. Contact stress in both members is equal. The worm goes through more contact cycles because of the ratio of the gear set. Compared to steel, bronze has a



lower strength, a lower endurance ratio, and a higher number of cycles required for infinite life. Fig. 6 uses these factors in a generalized, theoretical S-N curve. Stress levels that have a finite life for bronze would have an infinite life for steel. Since the bronze will fail at a fewer cycles, it is used for the member requiring the fewest cycles.

Gear mesh reaction forces are equal and opposite in both members. The worm is much smaller in diameter than the gear and has a greater span between supports. Therefore bending stress is greater in the worm, requiring it to be made from the stronger material.

Manufacturing methods also play a part in material choice. Grinding is generally used for accurate finish of high-hardness, heat-treated steels. Grinding the worm is a simple process, using the flank of a straight-sided grinding wheel. Grinding the gear requires a complicated process using a form dressed grinding wheel and a three-axis grinder.

Tin bronze has proved to be the most successful alloy for worm gears. It has a low coefficient of friction and a low rate of wear. Good heat conduction carries away heat generated in the mesh and dissipates it throughout the gear. Aluminum bronzes have higher strength, but also a higher coefficient of friction. A less obvious disadvantage of the higher strength alloys is lower ductility. Theoretical contact between a worm and gear is a line. In practice, the bronze deflects under load broadening the contact line to an area. The material deflects until the contact area broadens enough to support the load. A low-ductility material may have localized failure before reaching a large enough area. Small contact areas of a lower ductility material have higher localized contact temperatures, which further increase the sub-surface stresses.

The unique properties of tin bronze can be traced to its grain structure. When the bronze solidifies, partial segregation of the copper and tin occurs. High tin areas or grains are commonly called the delta phase. Hardness of the delta phase is approximately 320 Brinell. The high copper matrix supporting it is approximately 145 Brinell. The hard grains provide wear resistance and help reduce friction. The softer matrix allows surface defor-

mation to distribute stress. A simple model would be to picture marbles (delta phase) imbedded in clay (matrix).

Alternate gear materials may increase certain properties, but losses in others will tend to make them unsuitable for general use. For special applications bronze alloys other than tin bronze may perform better. Gear materials, such as cast iron, plastic, and even steel, have worked very well in certain applications. Each application must be thoroughly analyzed by a gear engineer before selecting alternate materials.

Worms are generally made from an alloy steel. Steel worms can be divided into hardened and non-hardened. Hardened worms are superior in most applications. When surface hardness of approximately 58Rc is used, several benefits are gained. Material strength is increased, friction is lowered, and wear is reduced. Often a worm can be reused after the gear has worn out.

Non-hardened refers to the surface being lower than the typical 58 R<sub>c</sub>. Non-hardened worms may actually have a heat treatment to bring up the core hardness for increased strength. In industrial applications, a core hardness of 300 Brinell is typical. Non-hardened worms are useful in applications with low continuous power and very high peak or shock loads. These applications are most often machine adjustments or mechanisms that are infrequently activated. Heat treating for increased surface hardness may be eliminated in low power applications to decrease cost. If a worm

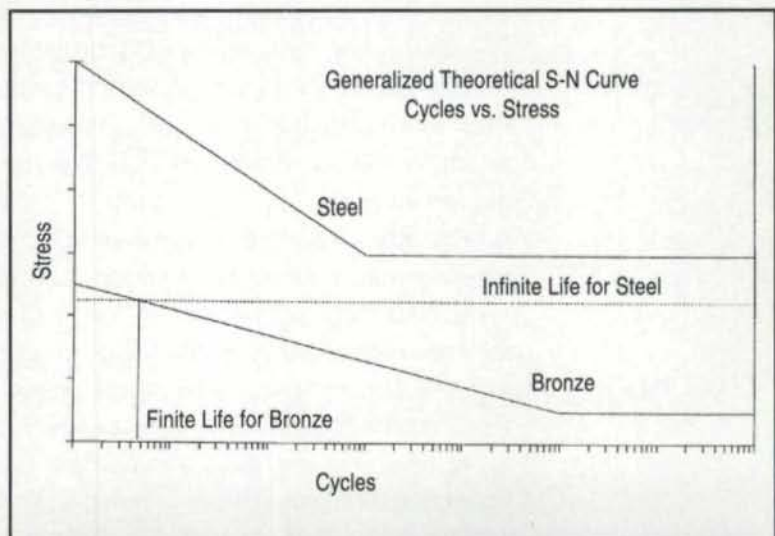

Fig. 6 - Generalized theoretical S-N curve.

is used with a cast iron or steel gear, it should be non-hardened.

#### **Backlash Measurement**

Backlash is the measure of the free clearance between the worm and the gear teeth. Measurement is done by locking the worm against rotation, setting a dial indicator on a gear tooth at the pitch radius, and rocking the gear back and forth. The total indicator reading is the measurement of backlash. Locking the gear and measuring worm rotation does not measure backlash. In an assembled unit where the gear teeth are not readily accessible, backlash can be approximated by placing the indicator on any convenient point that is fixed to the gear, such as a shaft keyway or coupling. This measurement must be multiplied by the ratio of the gear pitch radius to the measurement radius. Note that if the selected point is on the radius smaller than the pitch radius a multiplication of measurement error will occur.

$$\text{Backlash} = \frac{(\text{Measurement}) \times \text{Gear Pitch Radius}}{\text{Measurement Radius}}$$

#### **Lubrication**

Worm gearing has a high slide-to-roll ratio when compared to other types of gearing. Because of a high sliding component, it relies heavily on the generation of an oil film between the worm and gear. The oil film produces an effect similar to what happens when a speeding car hits a rain puddle. The car tire has a tendency to float on a wedge of water. In a car this is called hydroplaning; in gears it is called elasto-hydrodynamic lubrication (EHL). This is a simplistic description with other modes of lubrication coming into play, depending on conditions, but it gives the general idea.

For EHL to be the only lubrication mode, it must generate a film thickness greater than the surface roughness of the contacting parts. Film thickness is proportional to the sliding velocity and lubricant viscosity and inversely proportional to the unit load. High unit loads possible at the relatively low speed of worm gearing requires a very high viscosity lubricant. Viscosities of over 400 cSt at 40°C are normally used to prevent premature wear and high con-

tact temperatures. Under high loads the film can collapse, causing the surfaces to contact. This is called "boundary lubrication." In this lubrication mode, other properties (i.e., lubricity or slipperiness) of the lubricant become more important than the viscosity. In a worm gear set, a mixture of EHL and boundary lubrication are at work.

A satisfactory lubricant for most average applications is a AGMA 7 compounded oil. Low speeds require the higher viscosity of AGMA 8 compounded oil. Both are petroleum based mineral oils compounded with 3% to 10% fatty oils. These lubricants are sometimes referred to as steam cylinder oils. The compounded oil provides lower friction and better wear characteristics than a straight mineral oil. At the high pressures and temperatures in the contact area, a chemical reaction occurs on the tooth surface, forming a protective skin.

Extreme pressure oils (EP oils) are another type of lubricant that uses a surface acting chemistry. Most EP oils use sulfur, phosphorus, and/or chlorine additives, and are designed to work in steel-on-steel applications. When these oils are used with bronze under high temperature and pressure, conditions common in the mesh contact, the chemical reaction can go awry. The surface of the bronze can begin to flake off, causing massive wear, and intergranular stress corrosion can cause the teeth to break. There are EP oils designed for use with bronze that use a different additive package, and in certain applications a standard EP oil may work very well. When selecting a EP oil for bronze gearing make sure it was carefully reviewed.

Synthetic lubricants are also very common. They are more viscosity-temperature stable than mineral oils. This allows one lubricant to provide adequate service over a broader temperature range. They have longer service life, reducing the number of oil changes required. They reduce wear and friction, increasing gearbox life. Efficiency increases of 20% of the lost power are possible. Under severe conditions properly selected synthetic oils are outstanding. Many companies have found cost advantages using the more expensive synthetic oil for normal applications. ■

# Getting Started in Exporting

Nancy Bartels

**E**xporting. It's one of the hot strategies for helping boost businesses of all kinds, gear manufacturing among them. With domestic markets tight and new markets opening up overseas, exporting seems like a reasonable tactic. But while the pressure is on to sell overseas, there is equal, justifiable concern about whether the move is a good one. Horror stories abound about foreign restrictions, bureaucratic snafus, carloads of paperwork, and the complications and nuances of doing business in other languages and with other cultures.

Is exporting really a sound approach to competitiveness in the 90s? To find the answer, *Gear Technology* talked with Rick Norment, former executive director of AGMA and now the president of Norment & Associates, a consulting firm in Falls Church, VA, that specializes in trade and competitiveness development for precision components manufacturers.

**GT:** Let's begin with the very basic question. Is it true that everybody

should be looking into exporting now, or is this just a myth?

**RN:** You have to ask some fundamental questions about your company, and, depending on the answers, maybe the overall conclusion will be that exporting is not going to be an appropriate match. But having said that, it's important to remember the statement by Ken Butterworth, the Chairman of the Board at Loctite Corp., a manufacturer of adhesives which exports about 65% of its product. He says, "the biggest non-tariff barrier to U.S. exports is the attitude of the CEO." A lot of people start off with the perception that "I cannot export my product," and, therefore, they

**The biggest non-tariff barrier to U.S. exports is the attitude of the CEO.**



## MANAGEMENT MATTERS

don't even try. The fact is that getting into exporting is not nearly as complicated, time-consuming, or expensive as most people think.

**GT:** What are the kinds of questions a gear manufacturer should be asking before making the decision to export?

**RN:** First, you should be asking the basic marketing questions. Is there a market for this product in the country in which I wish to sell it? Can I sell competitively there? Can I sell for less than the local suppliers or for the same price with better quality?

The dramatic shift in exchange rates over the last couple of years have really been to our advantage here. Because the dollar has been substantially devalued and many other currencies have

**Managing a business today is hard work. Let "Management Matters" lend a hand. Tell us what management matters interest you. Write to us at P.O. Box 1426, Elk Grove, IL 60009, or call our staff at (708) 437-6604.**

### **Rick Norment**

*is the president of Norment & Associates, Inc., Falls Church, VA, a consulting firm specializing in government relations and trade and competitiveness development for precision components manufacturers. He is also former Executive Director of the American Gear Manufacturers Association.*

risen, the price equation is much more competitive now.

Another basic question to ask is: What is the average size of the order we're talking about? If you're talking about orders of \$500 or \$1,000 or even \$10,000, it could be difficult to turn a profit. But remember with gears, the price of the order is frequently measured in hundreds of thousands of dollars. In a case like that, there's enough of a differential as a result of the exchange rates to make exporting quite feasible.

**GT: Is there such a thing as a company being too small to export?**

**RN:** No. I know of gear companies with as few as 30 employees who have rather significant percentages of their total sales in exporting. It's the size of the order, not the size of the company that makes the difference. If your company is big enough to fill the order, then you're big enough to export it. Sixty-four percent of all products exported from the U.S. come from manufacturers with less than 500 employees.

**GT: What other things do you have to consider?**

**RN:** Actually, this is maybe the question that should be asked first: How am I going to get paid? This is not always a simple yes-or-no matter. But you certainly need to know if you can get a certified letter of credit from a customer, or is he going to want to barter or whatever. That's absolutely crucial.

Other things to consider

are matters like: What kind of trade restrictions does this country have? What about tariffs? What about certification requirements? What other countries are in there trying to sell the same kinds of products?

Also ask about in-country capability and competition. It always amazes me how someone will say, "I'm going to sell these gears in Germany." Well, that's a really tough market. They have a powerful domestic market already and a strong tradition of preferring German-made products. Unless you've got a significant quality and price differential, that's a very tough sell. It's not impossible, of course, but there are other markets that are a lot more accessible.

Most of the other factors that inhibit companies from getting involved with exporting are mental. I always counsel people to proceed with caution, and that's something that you can do with exporting. Start small. Do some exploration first. Look at the market, get a sense for it, talk to potential customers, find out what their prices are. You might be surprised at the answers you get.

For example, it's logical to look to Mexican and Canadian exporting. These are close-by countries. Getting across the border is much simpler; so are the customs and shipping regulations. Once you find you can export to Canada or Mexico and make a profit at it, then maybe you want to expand a little. But don't try to go from

zero exports to 30% of your product in the first year. Grow slowly.

Make the decision about which countries to enter on a rational, not an emotional basis. For example, in the past couple of years, there's been this gold-rush mentality about Central and Eastern Europe. People say, "Gee whiz, my grandparents were from Poland, so let's go to Poland." Poland may not be a bad choice, but you have to

evaluate it for your product, your niche. It's back to those old questions: Can you be competitive on price? Is there a barrier for getting into the market? Can you get easy access to it? Can your customer pay you?

**GT: It sounds as though exporting requires a lot of preparation, research, and fact finding before you even get into it. How difficult is it to get the kind of information you're talking about?**

## MANAGEMENT MATTERS

### Export Checklist

1. Is there a market for this product in this particular country?
2. Can I sell the product for less than the local suppliers or for the same price with better quality?
3. What size orders can I reasonably expect to be filling?
4. What kind of import restrictions does this country have?
5. Who are my competitors in this particular market?
6. How am I going to get paid?

### How expensive is it?

**RN:** Not nearly as expensive as you might think. You can find out what you need to know to enter a particular market for as little as \$10,000. And that price will include the cost of gaining the necessary information, having somebody assist you to analyze it and focus it specifically to your company and product needs, help develop some of the contacts that need to be made, and the plane ticket for the first trip. You certainly don't need to hire a Vice-President of International Markets.

### GT: And how long does this kind of information gathering take?

**RN:** If you're going to make a focused, intense effort, you can do it in as little as eight weeks. In that period of time, you can get a sufficient sense of the marketplace, find out whether or not you've got any real shot at it. It can, of course, take longer. Major corporations may have hundreds of people doing analysis for six months before they make a move to a particular country, but when they go in, they're talking contracts of hundreds of millions of dollars.

I'm a big believer in the KISS method. Keep it short and simple. There's no hard and fast rule about how much time or money this information gathering will take, but I think you should start off with the expectation that this is going to be something that requires a little bit of effort and money. As I said before, go slow. Take the time

to get a sense for your market. You may have a couple of false starts. The first couple of countries you look into may not be good choices, but in the end you'll find the right niche.

### GT: And where does one find this information?

**RN:** Two of the most useful resources are your state and federal governments. They will give you lots of guidance and assistance. They have access to information about countries all over the world. Find your local office of the U.S. Foreign and Commercial Service or your state office of economic development. Most major metropolitan areas have one or both of these. These are the people to talk to. They know the countries. They know the names of major players, etc.

Be aware, however, that the information you get from the government is going to be pretty general. They're not going to know the gear industry specifically, so you may want to also consult with someone who is familiar with the industry as well.

### GT: Once a company has made the decision to go into a country, what other kind of resources does it have to have in place?

**RN:** You need a way to get the orders. While you can send a salesperson into the country, that generally is not cost-effective. The best way is to find a manufacturer's rep or distributor for your product. Again, either government or private sources are available to help you find

# all in one

## GEAR DESIGN SOFTWARE

### How does it work?

**diseng v1.1**  
Is the first gear design software that really designs and not just calculates.

**diseng v1.1**  
Is really easy to use in your PC, because it permits achieving high performance results since it is also a research tool for analyzing the influence of each single parameter variation in the results.

**diseng v1.1**  
Also has preliminary dimensioning program presented as a spread sheet.

**diseng v1.1**  
Has standard English and metric unit systems included

Technical Support in the USA and Canada:  
THE DUDLEY TECHNICAL GROUP, INC.  
Gear Systems Consultants  
17150 Via Del Campo, Suite 308  
San Diego, California, 92127-2139 USA  
Phone (1-800) 354-5178 Fax (619) 487-4893

**FIRST**  
You define for each parameter, such as ratio, center distance, pressure angle, etc., a convenient set of values that you are really able to use.

**SECOND**  
You define your performance needs regarding Pitting Life, Bending Life, Scoring Probability, Reliability Level and Operating Conditions.

**THIRD**  
You wait a few seconds until diseng© finds out the best solution within your particular possibilities.

"Demo & Full Demo  
Disk Available"

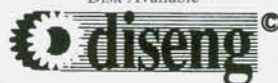

CIRCLE A-16 on READER REPLY CARD



## GEAR TECHNOLOGY

is looking for a few good pens.

WE'RE LOOKING FOR NEW MATERIAL ON ALL ASPECTS OF GEAR DESIGN, RESEARCH, MANUFACTURING, AND DEVELOPMENT. IF YOU HAVE AN ARTICLE YOU'D LIKE TO SHARE OR AN IDEA FOR AN ARTICLE YOU'D LIKE TO DISCUSS WITH ONE OF OUR EDITORS, CALL US AT (708) 437-6604. ASK FOR A COPY OF OUR "WRITER'S GUIDELINES."

the right person. Make a trip over to interview several candidates. Visit some major prospective customers and train the rep all in one shot. By having an "in-country" contact working for you all the time, you'll get the contacts and feedback on the market you need to make the orders.

**GT: What about specialized legal, financial, or other services?**

RN: The first thing to remember is that you don't have to put these people on your payroll. The expertise you're looking for can be subcontracted. You can hire a freight-forwarding company, which will do all the paperwork down to and including verification and validation of letters of credit, handling all the tariff forms, the shipping, the bills of lading. While not a big one, there will be a charge for this, of course. That's why we're back to the business of the size of the order. It has to be big enough to make it worth incurring these expenses.

The U.S. and Foreign Commercial Service can be a big help here too. They have lists of reliable lawyers, bankers, etc. in given countries. Say you need an Indian barrister who can speak Hindi. They'll be able to provide you with a list.

Another good place to look for suppliers of specialized skills, such as translation, is the *Export Yellow Pages*, which is available free from the U.S. Foreign and Commercial Service. It has lots of names.

**GT: How do you go about evaluating these people? How do you know they're any good?**

RN: This you handle just like you would getting any other kind of vendor. Ask for a client list. Talk to the people. Find out how long they've been in business and how many employees they have. Don't necessarily be put off by a small size company. Some of these people, especially if the service is narrowly focused, like translation, may have only two or three employees. Some really reliable people may have been doing this for years, working out of their homes. They've got great references and good client lists.

I would recommend trying to deal with vendors in your area. Most major metropolitan areas have this built-in infrastructure of expatriates from particular countries who have expertise in the areas you need. Again, the Foreign Commercial Service or your state's economic development agency can help you contact them.

**GT: When you're evaluating all this information, are there any red flags to look for that would indicate that a particular company is a bad export risk?**

RN: Some of the things we've already talked about are important. Are there trade barriers or other factors in the market that are going to make this too difficult? Political conditions are also important. For example, I don't think I'd consider try-

ing to export to Bosnia these days. I mean, think about it. Does the Bank of Bosnia have any money? Can a buyer get money out of the country? Can you get goods in? Somehow I doubt it.

On the other hand, you can't always just assume things. It's common these days to think you can't get a letter of credit from Russia. Well, you can if you have the right product and the demand is there. I just got in-

the factory level. Or he'll be there, but he'll have a different job. You have to remember that in these countries, there's a whole couple of generations who don't know how to do business outside the structure of central government planning. They don't know how to deal with a free market economy yet. It's not that they don't want to deal with you, but they don't always know how or have the organizational

## MANAGEMENT MATTERS

**When dealing with new markets and customers who speak a different language, people tend to listen more carefully. That same awareness of customer concerns should spill over into the domestic market.**

involved in an order for a half-million yards of denim. There's a Ukrainian cooperative of manufacturers looking for this denim, and they not only had a certified letter of credit, but the money on deposit at the Citibank of New York.

Political continuity is another factor to watch for. In Central and Eastern Europe especially, this is difficult. The person you're dealing with today may not be there in six months - even on

structure to do it. And that lack can make it really hard for you to make money exporting to those countries right now. In a few years it'll be different.

It's helpful to look at the evaluation process like a set of balance scales. Each of the factors we've been talking about is one weight you put on the scale. At some point, the balance is going to tip one way or the other. For example, sometimes the method of payment will be a

little convoluted, but if we're talking about an order of several million dollars, maybe it's worth the extra hassle.

**GT: What about the language barrier? How important is it to have someone on your payroll that speaks the language of the country or countries to which you're exporting?**

**RN:** It's useful. Again, we're back to either a manufacturer's rep or a distributor. It's helpful, but it's not absolutely necessary. The international language of the gear industry is broken English. And chances are, if you get a letter in Spanish or French or Japanese, there's somebody in the neighborhood who can help translate it.

**GT: What about product modifications? Should you plan to invest in changing your product to appeal to overseas markets?**

**RN:** Yes. You should be prepared to make some changes. As a gear manufacturer, for one thing, you have to be prepared to make your products for export to metric specifications.

On the other hand, don't redesign the product and then go to the market. That's backwards. Go to the marketplace first. Talk to the customers. Find out what they want. If your customer wants the machine in metric and painted purple, then that's what you should be prepared to give him. You can have the best product in the world, but if the customer doesn't want it, you don't have a sale.

This is one of the places

where thinking about exporting can help you in the domestic market as well. It's good discipline in this sense: When dealing with a new market, maybe with people speaking a different language, people tend to listen better, more carefully to what that customer wants. That same kind of attitude should spill over into the domestic market.

This same effect works on other parts of a business as well. Companies who export tend to become much more competitive, even in the domestic market. When exporting, you have to really watch your costs and your quality control and everything else because if a product is defective, it's not as easy to retrieve the part and fix it when it's sitting in Malaysia. Exporting companies tend to really tighten up their processes and improve their quality control, productivity, and efficiency, and while they're doing it for the overseas market, they're doing it for the domestic market as well.

**GT: One final question: If you had 50 words of advice to a gear company thinking of getting into exporting, what would they be.**

**RN:** First, don't fall into the trap of assuming that you can't export. Take a cautious, judicious look around, without any prior assumptions, and you'll be surprised what you might find. Then, go slow. Proceed with caution. But by all means, proceed. ■

# QUALITY GEARS

UP TO AGMA 15, MIL-I-45208A & MIL-STD-45662  
FROM A SINGLE GEAR TO LONG RUN PRODUCTION, INCLUDING  
PROTOTYPE & EMERGENCY REPAIR/REBUILD SERVICE  
SIZE RANGE: FROM UNDER 1" TO 48" DIAMETER

**Reishauer Ground Gears  
Most Type Gears Manufactured  
Complete to Customer Specifications**

- METRIC OR AMERICAN STANDARD
- SPUR, INTERNAL & EXTERNAL
- HELICAL, INTERNAL & EXTERNAL
- WORMS, WORM GEARS
- SERRATIONS • SHAFTS
- SPLINES, INTERNAL & EXTERNAL
- SPROCKETS • CLUSTERS
- SEGMENTS • SPINDLES
- RATCHETS • GEAR BOXES



Fully implemented SPC, and data communications capabilities, utilizing state of the art CMM's and M & M precision gear checker to 30" diameter to 18" face.



*Fairlane Gear, Inc.*

P.O. BOX 409, PLYMOUTH, MI 48170  
(313) 459-2440

In Mich. 1-800-482-1773 • FAX (313) 459-2941

CIRCLE A-18 on READER REPLY CARD

## Do You Have Our Next Cover?

*Gear Technology* is looking for good cover art. If you have a professional photo of gearing in operation that you think will look good on the next cover of *Gear Technology*, please send it for review:

**Gear Technology Art Dept.  
1401 Lunt Ave.  
Elk Grove Village, IL 60007**

# CLASSIFIED

## HEAT TREATING

### GEAR HARDENING SPECIALISTS with over 50 years experience

- **Carburizing and Hardening**
  - Aerospace and Military Approved
  - Integral Quench Furnaces to 48 X 72 X 36
  - Vertical Pit Furnace 18 X 126
  - Gleason Press & Hot Oil Quenching
- **Nitriding**
  - Large 60 X 72 Furnaces
  - State-of-the-art Processing for White Layer Control
- **Induction Hardening**
  - NATCO Contour Induction Hardening
  - High and Low Volume Coil Induction Hardening
  - Automotive Approved • SPC
- **Metallurgical Consulting & Design Assistance**



THE SYMBOL OF  
QUALITY AND SERVICE

THE CINCINNATI STEEL TREATING COMPANY  
(513) 271-3173 FAX (513) 271-3510

CIRCLE A-23 on READER REPLY CARD

### Contour Induction Hardening Specialists

#### Spur, helical and bevel gears

Our gear hardening equipment includes 4 NATCO submerged process machines and 3 AJAX CNC-controlled gear scanning machines. We can also tool to meet any production need. Write for a free brochure.

#### American Metal Treating Company

1043 East 62nd Street  
Cleveland, OH 44103  
(216) 431-4492  
Fax: (216) 431-1508

CIRCLE A-24 on READER REPLY CARD



### COMMERCIAL HEAT TREATING

services include:

carburizing                      carbonitriding  
annealing                        gas nitriding  
normalizing                      thru-hardening

Metallurgical lab testing available.

Mack Trucks, Inc.  
Dept. 3401  
13302 Pennsylvania Avenue  
Hagerstown, Maryland 21742-2693  
(301) 790-5400

CIRCLE A-25 on READER REPLY CARD

## SERVICE

### ITW GEAR INSPECTION SYSTEMS

Service - Upgrades - Rebuilds

75 years of design and manufacturing know-how go into the servicing, rebuilding, and upgrading of ITW gear inspection systems. **ITW designed them. ITW built them. ITW knows how to keep them running.**

- Factory loaners
- Component availability from your OEM supplier
- Latest technology in digital adjustments
- Computerized data evaluation

#### ITW Heartland

7300 W. Lawrence Ave. Chicago, IL 60656  
Phone: 708-867-5353 Fax: 708-867-3838

CIRCLE A-26 on READER REPLY CARD

### GEAR TOOTH GRINDING SERVICES

- Cost effective gear tooth grinding specialists
- Gear manufacturers are our only customers
- Prototype and production quantities
- Capacity to 27.5" P.D., 3.5 D. P.
- Able to match delivery to your requirements
- All service to AGMA standards with Certified Gear Inspection Equipment

#### PRO-GEAR COMPANY, INC.

23 Dick Road Depew, NY 14043  
Phone (716) 684-3811  
Fax (716) 684-7717

CIRCLE A-27 on READER REPLY CARD

### FELLOWS GEAR MEASURING REMANUFACTURING SPECIALIST

Complete Factory Rebuilding  
Quick Turnaround  
Calibration & Certification to MIL-STD  
Preventative Maintenance  
Complete Field Service  
Design Updates  
Engineering Support  
Leasing & Sales

#### OVERALL THE BEST IN THE BUSINESS

Profit from our 100 years experience



Profile Engineering, Inc.  
100 River Street  
Springfield, VT 05156  
802-885-9176  
Fax 802-885-3745

CIRCLE A-28 on READER REPLY CARD

**Rates:** Line classified - \$37.50 per line. 8 lines per inch. \$300 minimum. Classified Display - per inch (3" min.) 1X - \$170, 3X-\$160, 6X - \$150. Type will be set to advertiser's layout or *Gear Technology* will set type at no extra charge.

**Payment:** Full payment must accompany classified ads. Send check or Visa/Mastercard/American Express number and expiration date to: *Gear Technology*, P. O. Box 1426, Elk Grove Village, IL, 60009. **Agency Commission:** No agency commission on classifieds.

**Materials Deadline:** Ads must be received by the 25th of the month, two months prior to publication. **Acceptance:** Publisher reserves the right to accept or reject classified advertisements at his discretion.



## HELP WANTED

**MANUFACTURING MANAGER:** \$65,000. Single Helical Gear Boxes. Metalworking, Turning expertise. 120 employees.

**GEAR ENGINEER:** \$58,300. Process and Gear Design.  
**MANUFACTURING ENGINEERING MANAGER:** \$60,000. Multi-plant responsibility. Gear Cutting Large Diameter Gears.

**SUPERVISOR, SPIRAL BEVEL GRINDING:** \$53,200. Supervise 30.

Contact: Ann Hunsucker, Excel Associates, P.O. Box 520, Cordova, TN 38018 or call (901) 757-9600; or Fax (901) 754-2896.

To advertise in the  
classified  
section of  
**Gear Technology**  
call (708) 437-6604.



## SERVICE

**Our New, Modernized  
Recorder Amplifiers  
Improve Your Reliability**

**For Fellows and ITW Illitron**

Now we can replace your old recorder amplifiers with thoroughly modernized new units that will perform more reliably than the OEM equipment. Why? State-of-the-art electronics. Our new direct replacement units use signal conditioning integrated circuits - the number of components (and therefore the cost) is greatly reduced. Our designers also improved safety by adding fused output to pen motors and automatic thermal overload protection. Order yours today.

**PHONE 708 377-2496**

**FAX 708 377-2546**



Manufactured  
Gear & Gage, Inc.  
P.O. Box 7155  
Elgin, IL 60121

CIRCLE A-29 on READER REPLY CARD

# Put Our List On Your List

Our list can help you do the other things you have on your list. Such as buy a car...estimate social security...start the diet...check out investments...

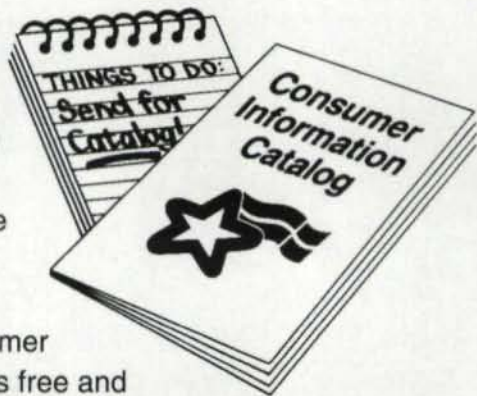

Our list is the Consumer Information Catalog. It's free and lists more than 200 free and lowcost government booklets on employment, housing, Federal benefits, and lots of ways you can save money.

So to shorten your list, send for the free *Consumer Information Catalog*. It's the thing to do.

Just send us your name and address. Write:

**Consumer Information Center  
Department LL  
Pueblo, Colorado 81009**

A public service of this publication and the Consumer Information Center of the U.S. General Services Administration

## One Of America's Best Run Companies Gives 95% Of Its Money To Charity.

CARE was recently named the best run, best managed charity in America. We aren't surprised.

95% of every dollar we receive goes to help impoverished people. Only 5% goes to run our organization.

No other company could survive on margins like that. But a lot of starving people can.

We're Helping People  
Learn To Live Without Us.

1-800-242-GIVE

**CARE**



## "SEEING IS BELIEVING"

Advertise in *Gear Technology*  
and see how many  
decision makers you can reach.

Call (708) 437-6604  
today and see for yourself.

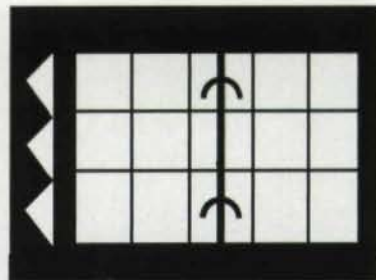

## CALENDAR

### MARCH 11-12

AGMA Technical Education Seminar. Ramada Hotel O'Hare, Rosemont (Chicago) IL. "Gear Failure Analysis" and "Gear Design & Analysis." Bob Errichello, seminar leader. Call AGMA at (703) 684-0211 for more information.

### MARCH 16-18

ASM International 14th Annual Heat Treating Conference & Exposition, Indianapolis, IN. Seminars on heat treating equipment, processes, and performance. Call (216) 338-5151, x530 for more information.

### APRIL 19-23

AGMA GEAR TRAINING SCHOOL, IIT Research Institute, Chicago, IL. Covering basics of hobbers, shapers, and inspection. Call AGMA, (703) 684-0211 for more information.

### APRIL 20-22

Quality Expo International. O'Hare Expo Center, Chicago, IL. Covering quality assurance/reliability equipment, systems, and services. For registration information, call (800) 323-5155 or fax (708) 260-0396. Outside the U.S. or Canada, call (708) 260-9700.

### APRIL 27-29

SME Advanced Gear Processing & Manufacturing Clinic. Dallas Marriott Arlington, Arlington (Dallas), TX. Topics include hobbing, skiving, deburring, and more, plus tabletop exhibits. To register call (800) 733-4SME or FAX (313) 271-2861.

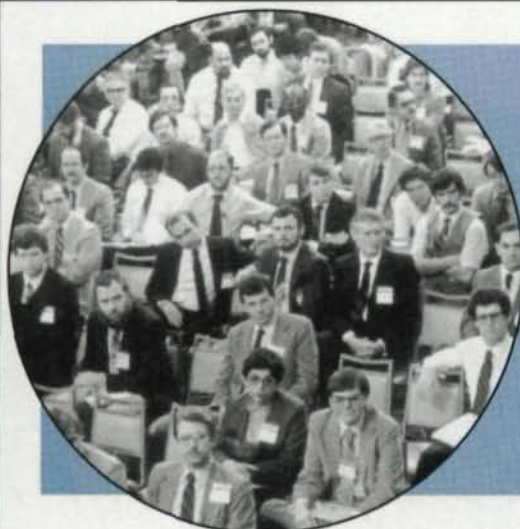

## ATTEND OUR ANNUAL KOEPFER GEAR SCHOOL

Knowledge  
is a powerful  
tool to have.

Koepfer America, builder of gear hobbing equipment and tooling, presents a two day training program for entry-level gear manufacturing personnel on May 16, 17 and 18, 1993.

Practical course content includes:

- Gear basics
- Production estimating
- Cutting tool use & support
- Fixturing techniques
- Inspection & interpretation of charts
- Problem solving session
- Equipment demonstration

For additional  
information  
telephone...



Aerospace quality at an affordable price  
**KOEPFER**  
Contact Dennis Gimpert • Koepfer America, Inc.  
635 Schneider Drive • South Elgin, Illinois 60177  
Telephone 708-931-4121 Fax 708-931-4192  
Jos. Koepfer & Söhne GmbH • Furtwangen, West Germany



CIRCLE A-20 on READER REPLY CARD

# Success

## Ajax Induction Heat Treating Solutions Let Us Provide One For You...

**Pick and Place.** Here's an opportunity to lower direct labor costs and have the built in versatility to handle a variety of parts without expensive retooling. Using simple pick and place movements, cylindrical parts can be induction hardened with consistently high quality. Here, reaction shafts are hardened at the rate of 300 parts per hour. Simple yet effective.

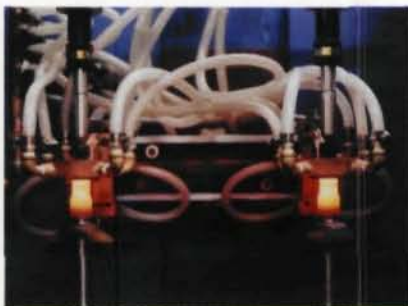

**ScanPak.** A versatile vertical scanner that allows the user to harden shaft-like parts from camshafts to hydraulic pistons, ScanPak is available in nine different configurations, in power ratings up to 800 KW, in frequencies to 50 KHz. Whether you need single spindle, dual spindle, or twin drive, there is a ScanPak exactly suited for you. ScanPak comes equipped with microprocessor-based machine control, integral heat station, and with spindle sizes up to 60".



**Ultra-Case** gear hardening—your answer to carburizing. Ultra-Case is a high speed method for contour gear hardening. It provides the user with the ability to surface harden gears at production line speeds while at the same time it solves dimensional distortion problems.

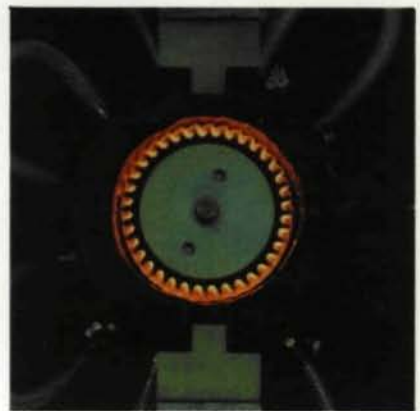

Let Ajax help make your next heat treat project a success. Write to: Ajax Magnethermic Corp., 1745 Overland Avenue, Warren, Ohio 44482. Call toll-free 1-800-547-1527, Fax (216) 372-8644 or in Canada call (416) 683-4980.

**Ajax Magnethermic**  
CORPORATION

The Way The World Inducts Its Business.....

WARREN, OHIO USA / TORONTO, CANADA / UNITED KINGDOM / CARACAS, VENEZUELA / SAO PAULO, BRAZIL  
SEOUL, KOREA / MELBOURNE, AUSTRALIA / BILBAO, SPAIN / TOKYO, JAPAN / FRASER, MICHIGAN

CIRCLE A-21 on READER REPLY CARD

# THE INDUCTION EDGE

TOCCO PROFILE HARDENING (TPH) eliminates three of a gear user's worst problems:

- tooth breakage
- pitting
- spalling

Gears processed by the TPH process exhibit increased hardness and strength at the pitch line with an optimum strength gradient at the root fillet. These metallurgical properties are achieved without excessive tip temperature and without tooth form brittleness.

Don't confuse the TOCCO TPH process with conventional dual frequency induction heating. The TPH process merges three distinct induction heating techniques: sequentially-programmed, audio low frequency preheating, incremental induction hardening and high intensity radio frequency final hardening. The result is good austenitic/martensitic transformation and beneficial residual compressive stress at the root with elevated hardness and strength/depth at the pitch line.

The TPH process accommodates a broad range of metals, including medium carbon steel, cast iron and powder metals. You're not locked into expensive alloy steels. The process is economical for batches of one or 1,000, and is used today by top automobile and gear manufacturers.

Gear Profile Hardening is another example of the "edge" TOCCO gives you in induction heating. Our metallurgists will send you a fresh report on TPH technology. All you need do is ask.

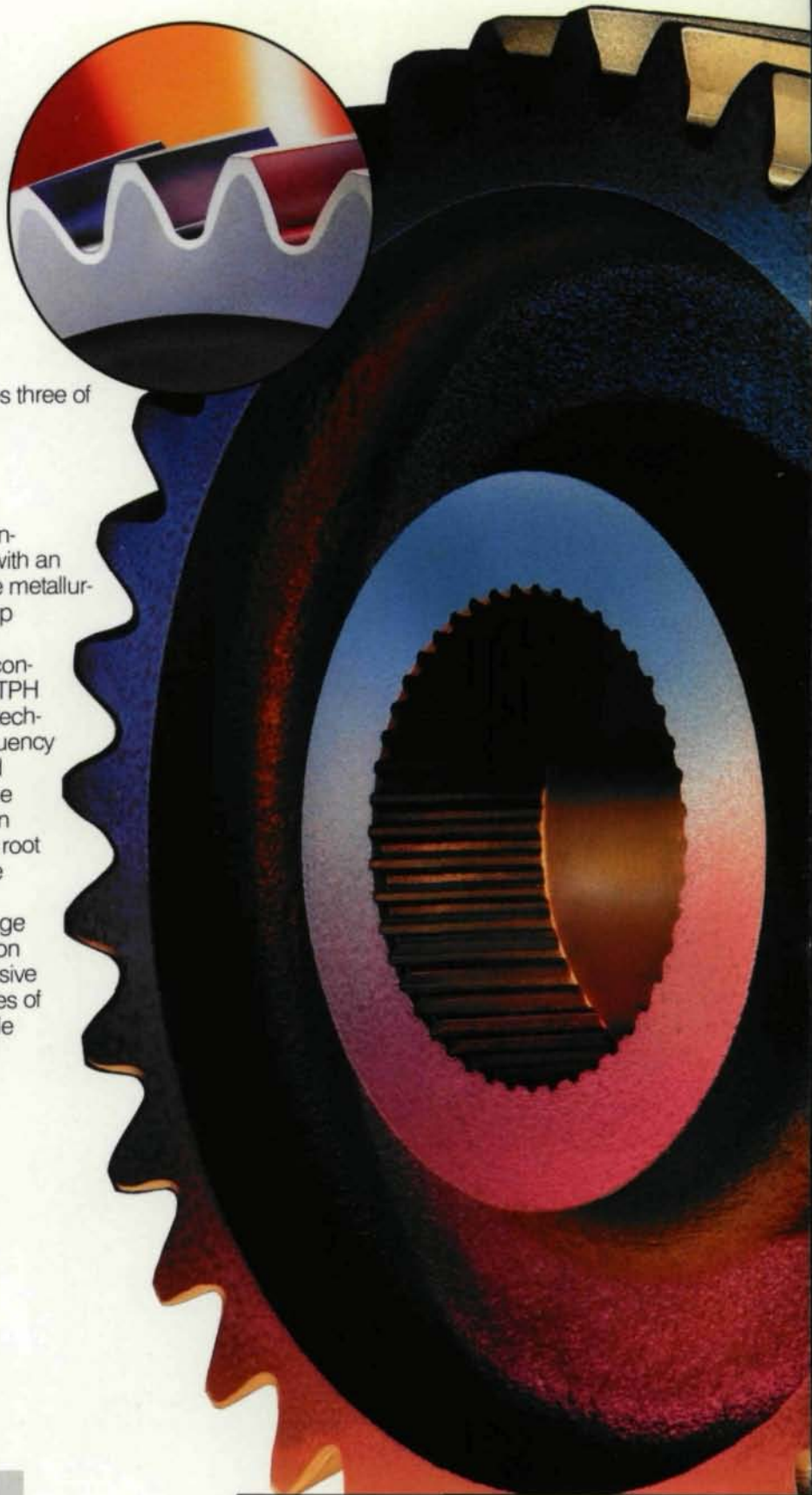
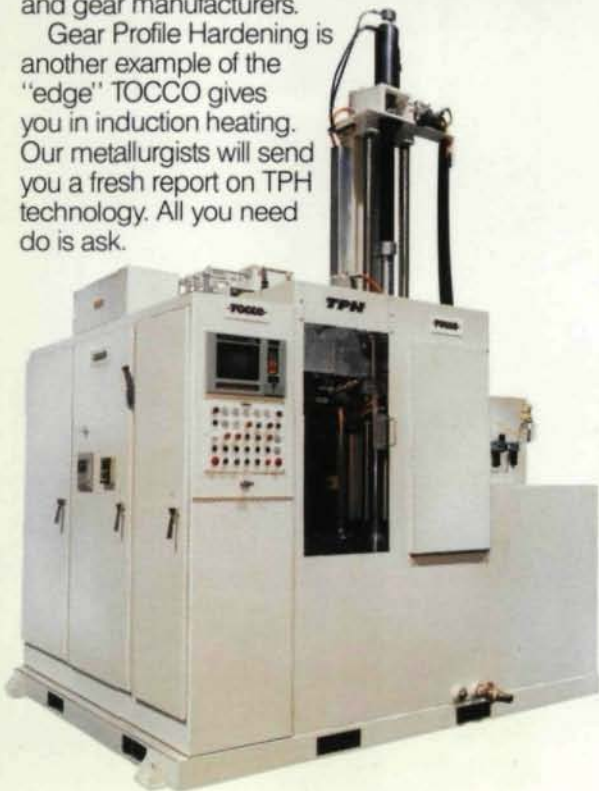

## TOCCO®

30100 Stephenson Hwy.  
Madison Heights, MI 48071  
TEL: (313) 399-8601  
FAX: (313) 399-8603

CIRCLE A-3 on READER REPLY CARD