

Application of the First International Calculation Method for Micropitting

Dr. Ulrich Kissling

Management Summary

The first edition of the international calculation method for micropitting—ISO TR 15144-1:2010—was just published last December. It is the first and only official, international calculation method established for dealing with micropitting. Years ago, AGMA published a method for the calculation of oil film thickness containing some comments about micropitting, and the German FVA published a calculation method based on intensive research results. The FVA and the AGMA methods are close to the ISO TR, but the calculation of micropitting safety factors is new.

In this paper, ISO TR 15144 is explained briefly and presents two calculation rules: method A and method B. Method A requires Hertzian pressure on every point of the tooth flank. This is based on an accurate calculation of the meshing of the gear pair that considers tooth and shaft deflections to establish the load distribution over the flank line in every meshing position. Such a calculation is very time consuming when using an FEM tool. Alternatively, specific analytical programs that are commercially available—e.g., *LDP*, *RIKOR*, *KISSsoft*—may be used. In either case the use of method A without such an advanced tool is impossible. Method B is much simpler in that the load distribution is defined for different cases as spur or helical gears—with and without profile modifications. Method B can be programmed as standalone software, maybe even in *Excel*. However, a restriction that arose in the last meeting of the ISO working group responsible for this topic limits considerably the application of method B: i.e., if gears with profile modification have to be verified, the tip relief C_a must correspond exactly to a proposed value C_{eff} . If not, the method for gears without any profile modification has to be used. As modern gear design specifies profile modification of different kinds, this is a critical limitation for the application of method B in ISO TR 15144.

Introduction

An ISO TR is a technical report that—typically after a 3-year period—will become an international standard. With the considerable number of new wind turbine installations over recent years, micropitting has become a critical issue in gearbox design. Indeed, even before its official publication, evaluation of micropitting risk based on ISO 15144 is a hot topic among authorities such as Germanischer Lloyd, the Hamburg-based classification society and technical supervisory organization.

The potential for micropitting is highly influenced by profile and flank line modifications. A newly available software tool can evaluate the micropitting risk by automatically varying different combinations of tip reliefs, other profile modifications and flank line modifications in combination with different torque levels, using method A. The user can define the number of steps for variation of the extent of modification; for example, tip relief C_a from 30 to 70 μm in 4 steps, crowning value C_β from 10 to 40 μm . Then all possible combinations $C_a=30$ (with $C_\beta=10, 20, 30, 40$), $C_a=40$ (...), etc., are checked combined with different user-defined torque levels. Any modifications including flank twist, arc-like profile modifications, etc., can be combined. The result is presented in a table, showing the safety factor against micropitting for different subsets of profile/flank modifications, depending on the torque level. Additionally, peak-to-peak transmission error, maximum Hertzian stress, wear, etc., are documented. This tool enables the possibility of reducing micropitting risk with profile modifications and is very helpful for designing an optimum gear modification for varying torque levels.

Three different gear sets with micropitting problems—example *D* (spur gear, module 10.93 mm, Z 18:18); example *U* (helical gear $\beta=19.578^\circ$ module 4.5 mm, Z 33:34); and example *F* (helical gear $\beta=9^\circ$, module 30 mm, Z 19:76) will be discussed.

Micropitting as Phenomenon

As explained in ISO TR 15144 (Ref. 1), micropitting is a phenomenon that occurs in Hertzian types of rolling and sliding contact that operate in elastohydrodynamic or boundary lubrication regimes. Micropitting is influenced by operating conditions such as load, speed, sliding, temperature, surface topography, specific lubricant film thickness and

(Printed with permission of the copyright holder, the American Gear Manufacturers Association, 1001 N. Fairfax Street, Fifth Floor, Alexandria, VA 22314-1587. Statements presented in this paper are those of the author(s) and may not represent the position or opinion of the American Gear Manufacturers Association.)

chemical composition of the lubricant. Micropitting is more commonly observed on materials with high surface hardness.

Essentially, micropitting is the generation of surface cracks; the cracks grow at a shallow angle to the surface and form micropits. The micropits are small relative to the size of the contact zone, typically of the order of 10–20 μm deep. The micropits can coalesce to produce a continuous fractured surface that appears as a dull, matte surface during unmagnified visual inspection (Fig. 1).

Micropitting is the preferred term for this phenomenon, but it has also been referred to as “grey-staining,” “grey-flecking,” “frosting” and “peeling.” Micropitting may stop on its own, but if allowed to progress it may result in reduced gear tooth accuracy, increased dynamic loads and noise. If it does not stop and continues to propagate it can develop into macropitting (classic pitting) and other modes of gear failure.

Classic pitting, however, is a completely different phenomenon. In this case the cracks start at a certain depth under the surface where shear stress—due to Hertzian pressure—is highest. This effect is well explained in the ISO 6336–2 standard.

ISO Technical Report 15144

The ISO Technical Report 15144–1 provides principles for the calculation of the micropitting load capacity of cylindrical, involute, spur and helical gears with external teeth. The basis for the calculation of micropitting load capacity of a gear set is the model of the minimum, operating-specific lubricant film thickness in the contact zone, $\lambda_{GF,min}$. For calculating micropitting risk, a safety factor S_λ is defined as the ratio between $\lambda_{GF,min}$ and the permissible, specific film thickness λ_{GFP} .

The permissible, specific lubricant film thickness λ_{GFP} is calculated from the critical, specific lubricant film thickness λ_{GFT} which is the result of any standardized test method applicable to evaluating micropitting load capacity of lubricants or materials by means of defined test gears operated under specified test conditions. λ_{GFT} is a function of the temperature, oil viscosity, base oil and additive chemistry and can be calculated in the contact point of the defined test gears where the minimum, specific lubricant film thickness is found, and for the test conditions where the failure limit concerning micropitting in the standardized test procedure has been reached. The most widely used test procedure is the FVA–FZG micropitting test (Ref. 2). Several oil providers already document the micropitting load stage following the FVA test in their oil specification.

The ISO TR 15144–Part 1, was published in December 2010; Part 1 contains the basic calculation method. The ISO committee responsible for this topic is currently working on Part 2, which will contain some examples of gear sets with micropitting. Part 2 will be very helpful in better understanding the application of the calculation rules as described in Part 1.

The technical report presents two calculation rules—methods A and B. The report stipulates that for method A, experimental investigations or service experience relating to micro-

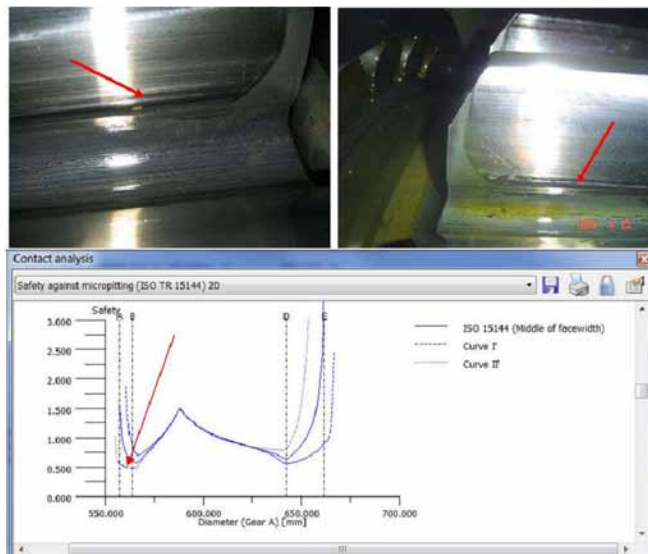

Figure 1—Traces of micropitting at the root of the flank of the pinion (photo courtesy CMD France); corresponding result of safety against micropitting (method A). Curves for left-side, middle and right-side of face width; gear Example F (helical gear, $m_n=30\text{ mm}$, $\beta=9^\circ$, $Z\ 19:76$).

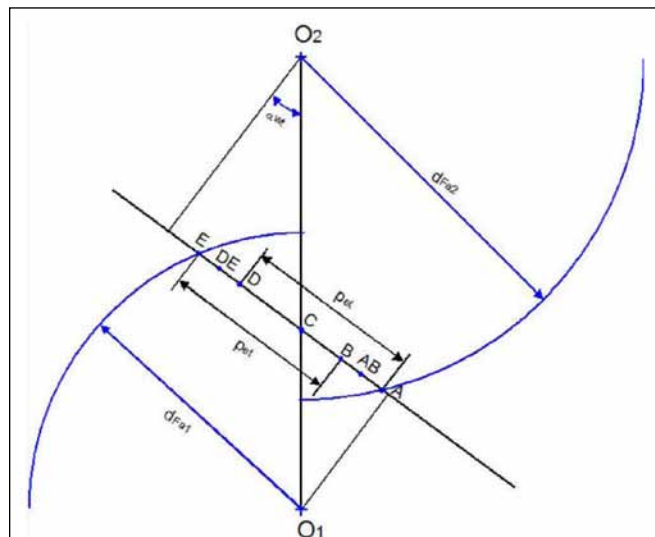

Figure 2—Significant points on path of contact where micropitting must be checked if using ISO 15144, method B; (Point A: beginning of contact, SAP; Point E: end of contact, EAP.)

pitting require that real gears are used. But this is not very practical when designing new gears; as will be shown in Part 2 of the technical report, a more practical approach when using method A is to first calculate the load distribution over the flank line in every meshing position, and then the Hertzian pressure on every point of the tooth flank, based on an accurate calculation of the meshing of the gear pair and considering tooth and shaft deflections. This is a most complicated contact analysis problem that could be solved using an FEM tool, but such a calculation is very time consuming. Alternatively, specific commercially available analytical programs may be used. Once the local Hertzian pressure and sliding velocity are determined, the local specific lubricant film thickness GF is calculated using the equations from the technical report.

The use of method B is much simpler; Hertzian pressure is defined by equations for such cases as spur or helical gears,

with and without profile modifications. The equations for the calculation of the local pressure and velocities are based on an unmodified involute tooth form. The calculation is performed for some of the critical points in the tooth meshing cycle, i.e.—points *A*, *AB*, *B*, *C*, *D*, *DE* and *E* (Fig. 2; Refs. 1 and 3). In these points the specific lubricant film thickness λ_{GF} is then calculated.

The technical report states that there are many influencing parameters for micropitting, such as surface topology, contact stress level and lubricant chemistry. And while these parameters are known to affect the performance of micropitting for a gear set, it must be re-stated that micropitting remains a topic of new research; the science has not yet been developed to allow these specific parameters to be directly included in the calculation methods. Also, since the correct application of tip and root relief (involute modification) has been found to greatly influence micropitting, application of the suitable values should be the rule.

Surface finish is another crucial parameter; at present, *Ra* is used but other aspects such as *Rz* or skewing have been observed to have significant effects that could be reflected in the finishing process applied.

Overview of Calculation Procedure

Calculation of micropitting safety factor. For calculating the risk of micropitting, safety factor S_λ is defined as follows: (1)

$$S_\lambda = \frac{\lambda_{GF, min}}{\lambda_{GFP}} > S_{\lambda, mi}$$

$\lambda_{GF, min}$ = min ($\lambda_{GF, Y}$) is the lowest specific film thickness over the meshing cycle

λ_{GFP} = the permissible specific film thickness; it may be determined by different methods

$S_{\lambda, min}$ = the required safety factor, to be agreed on between supplier and purchaser of the gearbox

The lowest specific film thickness ($\lambda_{GF, min}$) is defined as the minimum of all locally calculated film thickness values $\lambda_{GF, Y}$ (Eq. 2); the permissible film thickness λ_{GFP} is calculated (Eq. 5). The ratio between these two values ($\lambda_{GF, min}/\lambda_{GFP}$) results in a safety factor against micropitting S_λ , which then has to equal or surpass the required safety factor $S_{\lambda, min}$. As the calculation method is quite new and relatively few known data points are available, the general idea for the interpretation

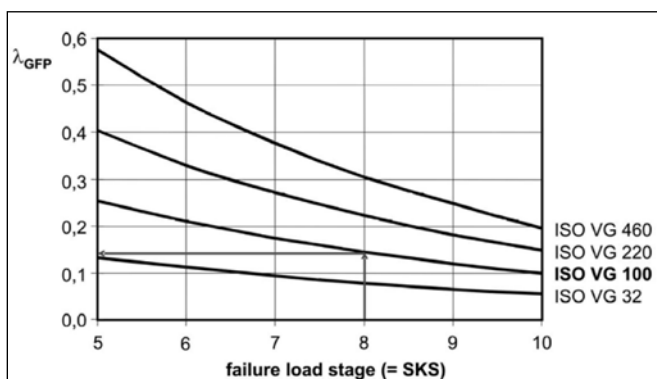

Figure 3—Required specific film thickness λ_{GFP} for mineral oil.

of the micropitting safety S_λ is to have a range between low- and high-risk limits:

Safety $S_\lambda > 2$	Low risk
$1 \leq$ Safety $S_\lambda \leq 2$	Limited risk
Safety $S_\lambda < 1$	High risk

Calculation of specific film thickness. For calculation of the safety factor S_λ , the local film thickness in the contact of the gears h_y must be known for the entire meshing cycle. It is then compared to the effective surface roughness: (2)

$$\lambda_{GF, Y} = \frac{h_y}{R_a}$$

where:

$$R_a = 0.5(R_{a1} + R_{a2})$$

$$h_y = 1600 \rho_{rel, Y} G_0^{0.6} U_Y^{0.7} W_Y^{-0.13} S_{GF, Y}^{0.22}$$

$\lambda_{GF, Y}$ = local specific film thickness

R_a = arithmetic surface roughness of the contact

R_{a1} = arithmetic surface roughness of the contact of gear 1

R_{a2} = arithmetic surface roughness of the contact of gear 2

h_y = local film thickness

$\rho_{rel, Y}$ = relative radius of curvature of the flanks in point *Y* (the point of contact between the gears)

G_0 = parameter for pressure viscosity describing the influence of the equivalent Young's modulus E_r and the pressure viscosity of the lubricant at mass temperature α_{00}

U_Y = local velocity factor

W_Y = local relative load factor

$S_{GF, Y}$ = local sliding factor

Determination of permissible specific film thickness λ_{GFP}

Determining permissible specific film thickness λ_{GFP} is the most difficult part to understand when referencing the technical report. There is a simple but inaccurate way to identify this value using a diagram (Ref. 4) where, for mineral oils, the permissible specific film thickness λ_{GFP} as a function of the viscosity of the lubricant ν and the load capacity number *SKS* of the lubricant (Fig. 3) are found. (5)

$$\lambda_{GFT} = 1.4 W_w \lambda_{GFT}(\nu, SKS)$$

λ_{GFT} = specific lubricant film thickness ascertained by tests

W_w = material factor (Table 1)

SKS = property of the lubricant; must be measured similar to the FZG number against scuffing; modern lubricants like those used in wind turbine gearboxes typically have an *SKS* number of *SKS*=10, but the data needs to be checked with the oil supplier on a case-by-case basis

The *SKS* number is determined according to the FVA information sheet (Ref. 2) and may be found on the lubricant data sheets of the leading suppliers. Note that Figure 3 is

Table 1—Material factor W_w (ISO TR 15144)

	W_w
Case hardening steel, austenite $\leq 25\%$	1.00
Case hardening steel, austenite $> 25\%$	0.95
Gas nitrided (HV > 850)	1.50
Induction -- or flame hardened steel	0.65
Through hardening steel	0.50

valid for mineral oils; synthetic oils will give (for the same viscosity and *SKS* number) a different, typically lower, permissible specific film thickness λ_{GFP} . Furthermore, it should be observed that the values given for λ_{GFP} are valid for case-carburized gears.

The accurate way to determine a value for the permissible specific lubricant film thickness is to use data of the oil performance from an FZG test rig. Many oils are tested on such a test rig, with gear-types FZG C–GF. In the oil specification you will then find the declaration, “Failure load stage (*SKS*) for micropitting test C–GF/8, 3/90’ = n ($n=5\dots10$)”. The *SKS* number corresponds to the torque level at which the gear in the rig with the test oil shows micropitting. If the *SKS* number of the oil is known, the micropitting calculation of the test rig gear is performed with:

Gear data as specified for the C–GF/8,3/90’ test rig gear (Ref. 2)

Torque and Hertzian pressure as specified by Table 2.

Oil data as viscosity, density $UC = D, V$ and D

Oil temperature θ_{oil} of the actual gear reducer (*not* the oil temperature used on the FZG test rig); note that it is recommended that the FZG test should be performed with the same oil temperature as used in the gear reducer. Typically, however, the FZG test is executed with 90°C oil temperature. Therefore data published by oil providers are valid for 90°C (if not otherwise declared).

The calculation of the test gear with this input data is done for point A because the minimum specific lubricant film thickness for the FZG type C test gear is always at point A. The resulting specific lubricant film thickness λ_{GF} , as per Equation 2 of ISO procedure, is the specific lubricant film thickness ascertained by tests λ_{GFT} (Eq. 5).

Unfortunately, the description of the method to get λ_{GFT} is missing in ISO TR 15144 Part 1; there will be more information in Part 2.

Recommendations for the Use of ISO TR 15144

Using method A. A problem when using method A—one that is more difficult than it may first appear—is calculation of the Hertzian pressure distribution over the tooth flank. It is well known that if different FEM tools are used to calculate the tooth contact, differences in the resulting pressure may be 30% and more. This depends on the mesh, boundary conditions and solution model. Similar problems are present when using commercially available software written to resolve specifically the tooth meshing contact.

Citing one of the problems encountered: a gear with a linear profile modification in the tip area has a small edge

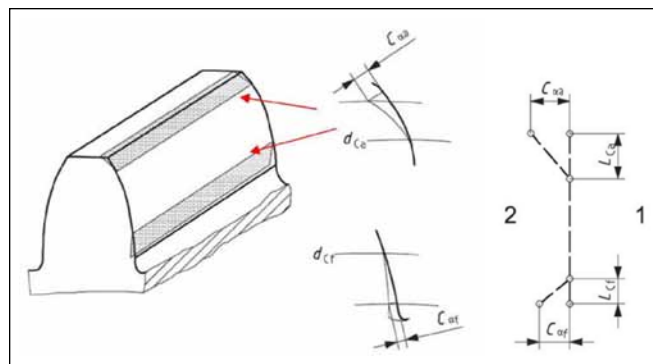

Figure 4—Tip and root relief as defined in ISO21771 (Ref. 5); at the point where the profile modification starts (arrow), a small edge in the tooth flank is formed.

at the point where modification begins (Fig. 4). In this point the radius of curvature is theoretically zero, so the Hertzian pressure is infinitely high. In reality, the edge does not exist because it is rounded during the grinding process, or the edge is reduced after some cycles due to wear. Therefore the pressure is much lower than theoretically assumed. A similar effect is encountered on the gear tip area, at the beginning of the chamfer. Very high pressure will result in low micropitting safety. As there is no “official” method available to deal with this problem, the abovementioned programs provide individual solutions that will result in somewhat different pressure values for the same tooth form.

Using method B. Within method B the local Hertzian pressure is calculated with equations. This is relatively simple for involute gears having no profile modification. In this case it is easy to get the load distribution over a meshing cycle. For gears with profile modifications, the load distribution is more complex; i.e., depending on the amount of tip relief C_a (Fig. 4), load at the beginning and end of the contact is reduced. Method B currently proposes two different methods to determine load distribution—one for non-modified gears and one for gears with optimum tip relief on one/both gears.

This begs the question: What is an optimum tip relief?

This is defined in the technical report with the “effective tip relief” C_{eff} . If the tip relief of the pinion C_{a1} is equal to C_{eff} , then the load distribution for optimal tip relief can be adopted; it is the same for the gear if C_{a2} is equal to C_{eff} . If the gears have a tip relief smaller than C_{eff} , the technical report recommends interpolation between the load distribution—with and without profile modification. This may change in the future, as many experts insist that load distribution equations for gears with profile modification can only be applied if the modification is “optimal.” If not, the equations for non-modified gears must be adopted.

The upshot here is that non-modified gears can be calculated with method B, but not modified gears. For modified gears, the question is whether the modification is indeed optimal or not. As indicated later in this report, a study using method A to

Table 2—Torque T_1 , line load F_{bb} and corresponding Hertzian pressure on FZG test rig [Fig. 2]

<i>SKS</i> number	Torque T_1 (Nm)	Line load F_{bb} (N/mm)	Hertzian pressure at the pinion at point A (N/mm ²)
5	70.0	63.3	764.0
6	98.9	89.1	906.4
7	132.5	119.0	1047.6
8	171.6	153.7	1191.0
9	215.6	192.7	1333.0
10	265.1	236.3	1476.2

No.	a [mm]	m [mm]	α [°]	β [°]	z_1	z_2	x_1	x_2	h_a	h_b	h_c	SF_{min}	$SF_{H_{min}}$	SB	v_s [m/s]	FFTE [μ m]	Slam
1	140.000	4.000	20.000	19.578	36	37	0.488	0.897	1.285	1.173	2.459	8.887	0.822	0.872	5.922	2.130	1.170
2	140.000	4.000	20.000	19.578	36	37	0.288	0.797	1.288	1.173	2.461	8.896	0.822	0.868	5.440	2.159	1.192
3	140.000	4.500	20.000	19.578	35	37	0.383	0.697	1.288	1.173	2.462	8.904	0.822	0.864	4.994	2.160	1.201
4	140.000	4.000	20.000	19.578	27	38	-0.094	0.294	1.521	1.173	2.695	8.972	0.842	0.720	6.905	1.724	1.170
5	140.000	4.000	20.000	19.578	37	38	0.006	0.186	1.524	1.173	2.698	8.988	0.843	0.842	6.386	3.483	0.804
6	140.000	4.000	20.000	19.578	27	38	0.109	0.096	1.525	1.173	2.698	8.999	0.843	0.943	5.908	3.446	0.869
7	140.000	4.000	20.000	19.578	38	39	-0.531	-0.346	1.758	1.173	2.891	1.060	0.814	0.609	7.465	2.835	0.757
8	140.000	4.500	20.000	19.578	32	33	0.378	0.783	1.297	1.043	2.340	8.995	0.822	0.862	6.063	4.595	0.665
9	140.000	4.500	20.000	19.578	32	33	0.478	0.683	1.300	1.043	2.343	1.005	0.823	0.869	6.140	1.253	1.135
10	140.000	4.500	20.000	19.578	32	33	0.578	0.583	1.300	1.043	2.343	1.014	0.823	0.869	3.654	1.217	1.211
11	140.000	4.500	20.000	19.578	33	34	-0.192	0.192	1.541	1.043	2.584	1.086	0.834	0.620	7.827	1.460	1.638
12	140.000	4.500	20.000	19.578	33	34	-0.092	0.092	1.544	1.043	2.587	1.111	0.825	0.718	7.247	0.605	0.680
13	140.000	4.500	20.000	19.578	33	34	0.000	-0.004	1.545	1.043	2.588	1.130	0.825	0.804	6.720	0.881	0.744
14	140.000	5.000	20.000	19.578	26	30	0.171	0.567	1.358	0.939	2.288	1.106	0.820	0.688	7.705	1.320	0.859
15	140.000	5.000	20.000	19.578	29	30	0.271	0.467	1.362	0.939	2.290	1.122	0.822	0.759	7.112	3.671	0.945
16	140.000	5.000	20.000	19.578	29	30	0.371	0.367	1.362	0.939	2.291	1.133	0.822	0.854	6.581	3.227	1.028
17	140.000	5.000	20.000	19.578	30	31	-0.364	0.007	1.604	0.939	2.543	1.195	0.810	0.509	8.989	3.957	0.850
18	140.000	5.000	20.000	19.578	30	31	-0.264	-0.093	1.608	0.939	2.546	1.238	0.811	0.590	8.342	2.932	0.694
19	140.000	5.000	20.000	19.578	30	31	-0.164	-0.193	1.608	0.939	2.547	1.270	0.812	0.662	7.791	2.848	0.501

Figure 5—Result of the fine-sizing procedure, possible variants to gear Example U (corresponding to number 13 in the list, $S_h=0.744$); No. 3 shows best result for micropitting $S_h=1.302$; i.e., safety factor is increased by 75%.

find the best micropitting safety factor by varying C_a shows that the optimum C_a is not at all equivalent to C_{eff} (Figs. 7–8).

So, what is an optimum modification?

As profile modifications are considered crucial in anticipating the risk of micropitting, it can be a real problem for an engineer with no access to a tool using method A, as method B may not provide realistic results in such a situation.

Furthermore, profile crowning or long tip relief (not short tip reliefs as used for method B) yield better results in mitigating micropitting risk. This type of modification is not covered by method B.

Optimization of Micropitting Safeguards

How to optimize. Micropitting is most critical in areas of high pressure and high sliding velocity. Sliding velocity is always highest at the beginning and end of the meshing contact. Combined with high pressure in the same areas, micropitting risk is increased. In response, optimization of the macrogeometry (as module, tooth number, profile shift) intended to reduce the sliding velocities is a good strategy. Included in the *KISSsoft* calculation software (Ref.7) is a tool developed in 1987 for optimizing gear pairs and planetary stages (Ref. 8) called “fine-sizing-routine.” Based on a user-defined range of parameters (module range, helix angle range, etc.), the software presents a large number of possible solutions covering the full parameter space and presents a list of calculated data (geometry, safety factors,

characteristics such as sliding, losses, weight, transmission error); also included is the micropitting safety factor according to the user’s choice of method B or A. As shown (Fig. 5), by keeping the center distance, face width and helix angle unchanged, and with reduction a ratio variation smaller than 0.5%, the safety factor against micropitting can be raised from 0.744 up to 1.302 simply through variation of module (from 4.0 to 5.0 mm) and the profile shift coefficient x_1 . It should be noted that the best variant has the lowest sliding velocity of all variants.

Using Method A with contact analysis for every variant is clearly a large calculation task; total calculation time for these 19 variants was about 10 minutes. Note that doing the same using an FEA tool would require days.

It is quite possible to improve the safety factors even more if a wider range of module and/or pressure and helix angle is used. There are of course limits in what can be achieved, as when module or tooth number should or cannot be changed. In this case further optimization can be achieved with profile modifications.

Optimization of profile modifications. The risk of micropitting is highly influenced by profile and flank line modifications. A new extension in *KISSsoft* (Ref. 8) can evaluate the risk of micropitting for gears by automatically varying different combinations of tip reliefs, other profile modifications and flank line modifications in combination with different torque levels and using method A. The user can define the number of steps for variation of the amount of modification; for example: tip relief C_a from 30 to 70 μ m in four steps; crowning value C_β from 10 to 40 μ m (Fig. 6). Then all possible combinations $C_a=30$ (with $C_\beta=10, 20, 30, 40$), $C_a=40$ (...), etc., are checked and combined with different (user-defined) torque levels. Any modifications including flank twist, arc-like profile modifications, etc., can be combined.

The result is presented in Figure 7, which displays the safety factor against micropitting (method A) for different subsets of profile/flank modifications, depending on torque level. Additionally, peak-to-peak transmission error, maximum Hertzian stress, wear, etc., are documented. This table is very helpful in showing the possibilities for reducing the micropitting risk with profile modifications and to find an optimum gear modification for different torque levels.

The effect of different variants of profile modification on the micropitting safety factor is obvious (Figs. 7–8). It is

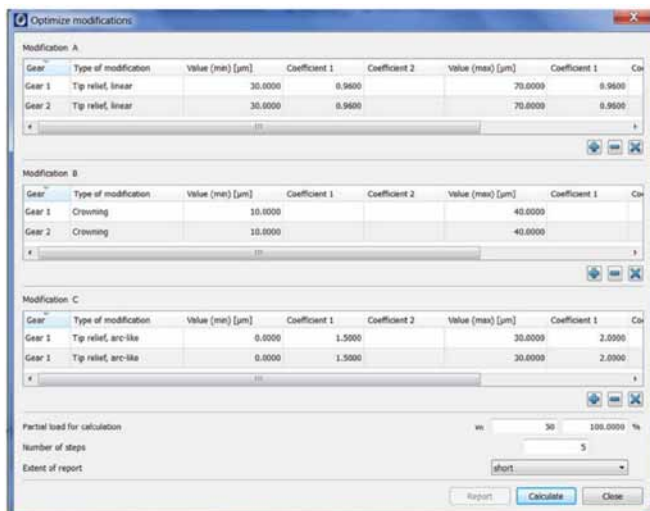

Figure 6—User interface for the optimization of profile modifications for best micropitting performance.

interesting to see that in these examples the highest safety factor S_{λ} is reached at a tip relief C_a , which is significantly lower than the optimum relief C_{eff} , as defined by ISO TR 14155. This is another indication that method B (based on C_{eff} for teeth with profile modifications) is of limited accuracy when using profile modifications. In the case of the spur gear (Fig. 9), a surprisingly small effect of the different modifications is found.

It is also noteworthy that profile crowning or long (linear or arc-like) profile modifications have normally higher safety factors than short profile modifications. Best results are obtained with profile crowning.

AGMA 925–A03

AGMA 925–A03 (Ref. 5) is an enhancement of ANSI/AGMA 2101–D04, Annex A. Various effects of gear surface distress are included, such as scuffing and wear, and micropitting and macropitting. Both methods use the Blok (Ref. 11) equation for the determination of the flash temperature. As not all factors used are exactly identical, the flash temperature (increased gear surface temperature in the contact) calculated following AGMA or ISO is slightly different (Fig. 10). The difference is due mostly to a different definition of the mean friction coefficient.

In AGMA 925 the micropitting calculation of the lubricant and specific lubricant film thickness is defined, but not a resulting safety factor. Although calculation of specific lubricant film thickness does not provide a direct method for assessing micropitting load capacity, it can provide an evaluation criterion when applied as part of a suitable, comparative procedure based on known gear performance. The calculation procedure for the local film thickness h_y (Eq. 4) ISO TR15144 and the line contact central film thickness in AGMA 925 h_c (Ref. 5) are both based on the same theory developed by Dowson (Refs. 6 and 10), with some factors slightly different. The main difference in ISO is the local sliding factor S that takes the flash temperature into account. AGMA typically uses the mean tooth temperature θ_M for local lubricant viscosity, while ISO uses the local contact temperature θ_B . The contact temperature is the sum of the mean tooth temperature plus the flash temperature. Therefore, in the meshing point C (where the flash temperature is zero), there is a smaller difference between AGMA and ISO, but in points with high flash temperature, AGMA calculates a much higher oil film thickness (Fig. 11; Ref. 7). It is known that the central film thickness is about 32% greater than the minimum film thickness; refer also to factor 1.316 in AGMA 925 (Ref. 5) that is used to obtain the risk assessment for wear. When we compared the two methods we found this approximate difference between the values in ISO and AGMA for the oil film thickness (Fig. 11).

Conclusions

The first edition of an international standard for micropitting—ISO TR 15144:2010—proposes a method for predicting potential micropitting. The concept and most important equations are explained. But method B, although relatively simple to apply, is of limited use for gears with profile modi-

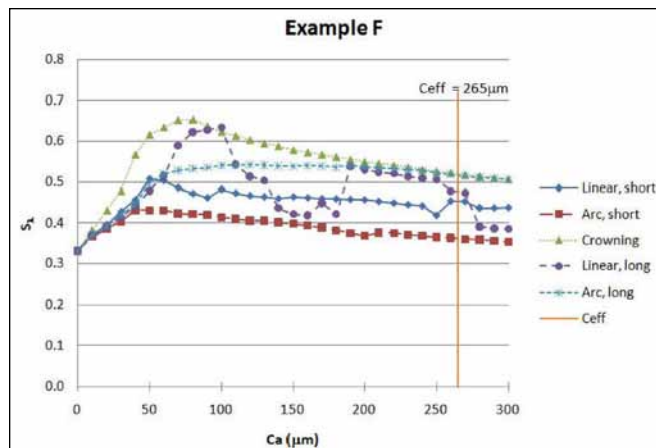

Figure 7—Effect of different tip relief C_a and profile modification type on micropitting safety factor S_{λ} , Example F (helical gear, $m_n=30$ mm, $\beta=9^\circ$, Z 19:76).

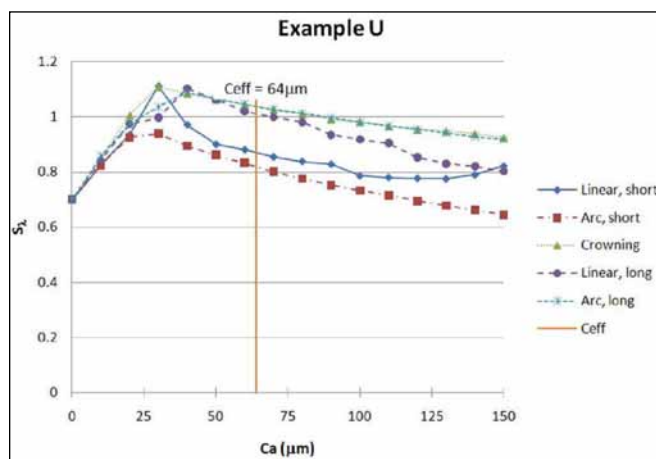

Figure 8—Effect of different tip relief C_a and profile modification type on micropitting safety factor S_{λ} , Example U (helical gear, module 4.5 mm, $\beta=19.578^\circ$, Z 33:34).

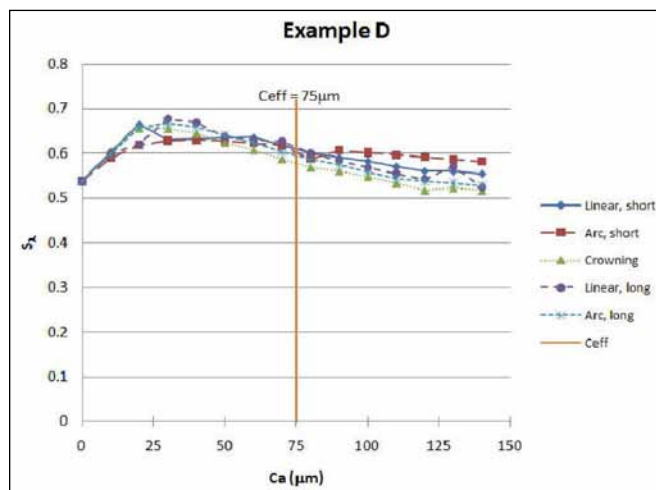



Figure 9—Effect of different tip relief C_a and profile modification type on micropitting safety factor S_{λ} , Example D (spur gear, module 10.93 mm, Z 18:18).

fications; for such gears method A must be used. Yet method A needs a software tool able to model the tooth contact to arrive at the local Hertzian pressure distribution—a complex task.

Mitigation of micropitting can be improved through macrogeometry optimization; the example presented here has shown that without changing the overall dimensions of the gear set, the micropitting safety factor can be improved significantly—by 100% and more. A generally used method in this regard is to use profile modifications. In some examples the effect of the variation of the tip relief and of the type of modification is shown. To simplify this optimization a new software tool was developed that automatically allows checking of many variants automatically. Profile crowning or long (linear or arc-like) profile modifications have normally higher safety factors than short profile modifications. Ergo, best results are obtained with profile crowning. 

References

1. ISO TR 15144-1:2010: Calculation of Micropitting Load Capacity of Cylindrical Spur and Helical Gears.
2. FVA Information Sheet 54/7: Test Procedure for the Investigation of the Micropitting Capacity of Gear Lubricants, 1993.
3. ISO 21771:2007/Gears: Cylindrical Involute Gears and Gear Pairs—Concepts and Geometry.
4. Theissen, J. “Computation of Security against Grey-Spotting of Industrial Transmissions on the Basis of the New Computing Procedure FVA 259,” DMK 2003.
5. AGMA 925-A03: Effect of Lubrication on Gear Surface Distress.
6. Dowson, D. and G.R. Higginson. *Elastohydrodynamic Lubrication—the Fundamentals of Roller and Gear Lubrication*, Pergamon Press (London), 1966.
7. Beermann, S. “KISSsoft Calculates Micropitting for the Wind Energy Sector,” *Wind Energy System* magazine, October 2010.
8. <http://www.kisssoft.com>
9. Kissling, U. “Concept for the Efficient Interpretation and Optimization of Planetary Gears According to Different Criteria,” VDI-Berichte No.1460; VDI-Verlag, Düsseldorf, 1999.
10. Dowson, D. and S. Toyoda. “A Central Film Thickness Formula for Elasto-Hydrodynamic Line Contacts,” *Fifth Leeds-Lyon Symposium Proceedings*, Paper 11, 1978.
11. Blok, H. “Surface Temperatures under the Conditions of Greasing without Extreme Pressure,” *Second World Petroleum Congress*, Paris, June 1937.

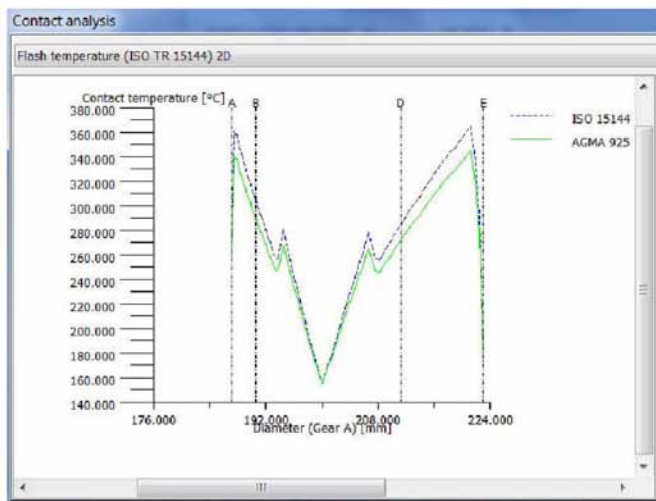

Figure 10—Calculation of the local tooth temperature according as ISO 15144 and AGMA 925; data used of Example D (spur gear, $m_n = 10.93$ mm, Z 18:18).

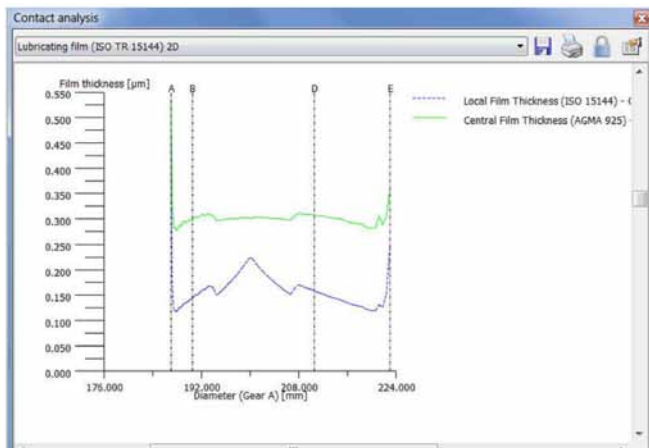

Figure 11—Calculation of the oil film thickness according as ISO 15144 (local film thickness) and AGMA 925 (central film thickness); data used Example D (spur gear, $m_n = 10.93$ mm, Z 18:18).

Dr. Ulrich Kissling studied mechanical engineering at the Swiss Federal Institute of Zurich (ETH). His doctoral thesis, in collaboration with a leading Swiss textile machines company, was completed in 1980. From 1981–2001, he worked as a calculation engineer, technical director and then as managing director of Kissling Co., a Swiss gearbox company located in Zurich focusing on planetary, turbo and bevel-helical gearboxes for industrial applications and in the ski business. In 1998, he founded KISSsoft AG and acts as CEO. Dr. Kissling is chairman of the NK25 committee (gears) of the Swiss Standards Association (SNV) and voting member for Switzerland in the ISO TC 60 committee. He has published over 50 publications on calculation procedures for machine design and has been involved in numerous engineering projects ranging from micro plastic gears to large open gears.