

# Longitudinal Tooth Contact Pattern Shift

J.B. Amendola, J.B. Amendola III and D. Yatzook

## Management Summary

After a period of operation, high-speed turbo gears may exhibit a change in longitudinal tooth contact pattern, reducing full face width contact and thereby increasing risk of tooth distress due to the decreased loaded area of the teeth.

But this can be tricky—the phenomenon may or may not occur. Or, in some units the shift is more severe than others, with documented cases in which shifting occurred after as little as 16,000 hours of operation. In other cases, there is no evidence of any change for units in operation for more than 170,000 hours.

This condition exists primarily in helical gears. All recorded observations here have been with case-carburized and ground gear sets.

This presentation describes phenomena observed in a limited sampling of the countless high-speed gear units in field operation. While the authors found no existing literature describing this behavior, further investigation suggests a possible cause. Left unchecked and without corrective action, this occurrence may result in tooth breakage.

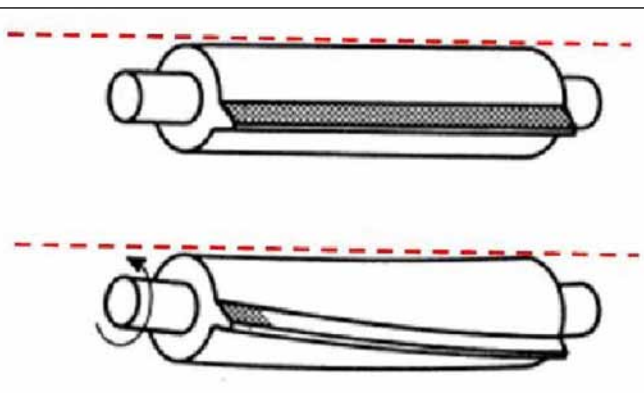

Figure 1—Tooth contact patterns of a spur-toothed pinion without longitudinal correction at rest (top) and with load (bottom) applied.

*(Printed with permission of the copyright holder, the American Gear Manufacturers Association, 1001 N. Fairfax Street, Fifth Floor, Alexandria, VA 22314-1587. Statements presented in this paper are those of the author(s) and may not represent the position or opinion of the American Gear Manufacturers Association.)*

## Introduction

Field inspection of high-speed turbo gears after an undefined period of operation may detect a change in the mating contact pattern of the gear mesh.

This has been observed on gear rotors with the following characteristics:

- Case-carburized and ground gear elements
- Relatively large face widths (greater than 300 mm)
- Pitch-line velocities greater than 100 m/s
- Modified leads accounting for both mechanical deflections and thermal deformation
- Operating hours with as little as 16,000 hrs to as much as 170,000 hrs

## Lead Corrections for High-Speed Gear Sets

Every gear set is subject to torque, resulting in elastic deflection of the gear tooth parts as well as the entire rotor body. Individual teeth bend, while pinion and wheel bodies twist, bend and expand under the effect of the torque, load and centrifugal forces (Fig. 1).

For high-speed gear sets, the mechanical deflections described herein are compounded with additional factors that result in further deformation of the gear teeth, i.e.:

A churning of the lube oil and frictional losses in the bearings cause the rotor bodies to overheat and consequently expand.

The pumping action of the oil and air entering the gear mesh produces an increased asymmetrical temperature gradient of the gear tooth along the length of the tooth flank, resulting in added deformation.

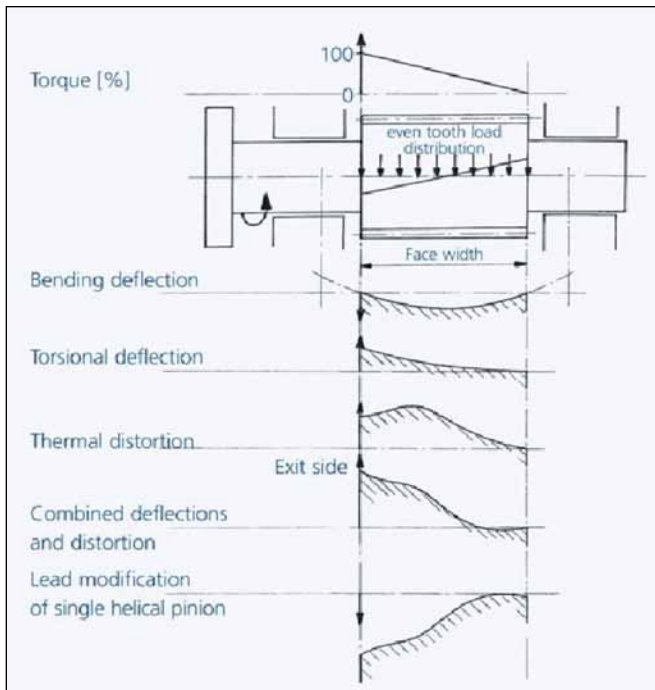

Figure 2—Schematic of single-helical tooth deflection with added parameter for thermal deformation and the associated lead correction.

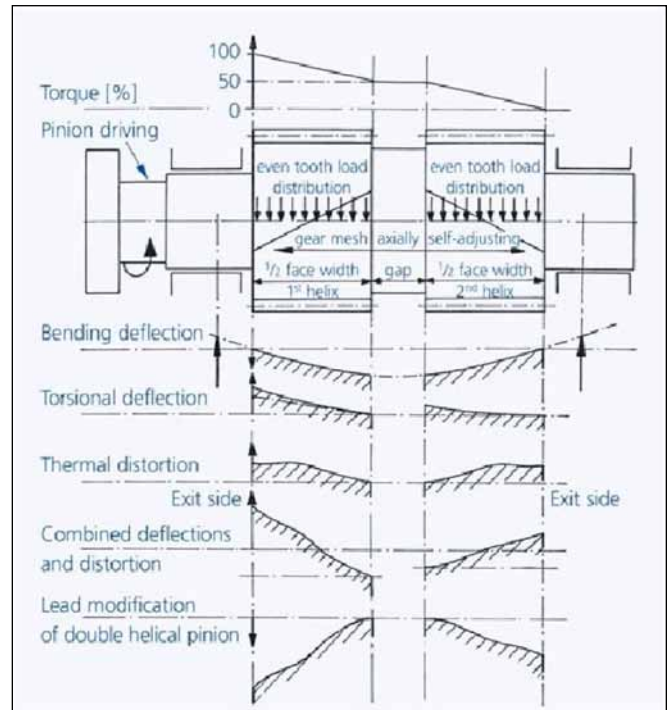

Figure 3—Schematic of double-helical tooth deflection with added parameter for thermal deformation and the associated lead correction.

Special consideration must therefore be given to compensate for these mechanical deflections and thermal distortions so that the load across the gear face is uniformly distributed under normal operating conditions.

Tooth modification for gear sets with pitch-line velocities greater than 100 m/s require careful awareness of thermal distortion. The resulting thermal deformation, in addition to the mechanical deflections, requires a composite profile and longitudinal modification to achieve proper load distribution under operating conditions (Figs. 2–3).

Investigations by Martinaglia (Ref. 9) were performed to accurately determine temperature conditions in a high-speed pinion (Fig. 4).

The dimensional parameters of the rotor configuration define how the lead is modified; its derivation is specific for a continuous, single- or double-helix. Therefore this dimension is largely dependent on the experience gained by years of observation of tooth-bearing patterns at nominal loads, in turn leading to accumulated, empirical values.

### Early Observations

Evidence of a longitudinal tooth contact shift was first observed by Artec Machine Systems in the early 1990s. When first observed, it was thought to have resulted from changes in the foundation or other external influences of the gear unit inducing a small misalignment in the mesh. However, subsequent experience revealed a curious shift of the contact pattern. Since this observation did not consistently manifest itself when inspecting other installations, the cause of the phenomenon remained questionable for a num-

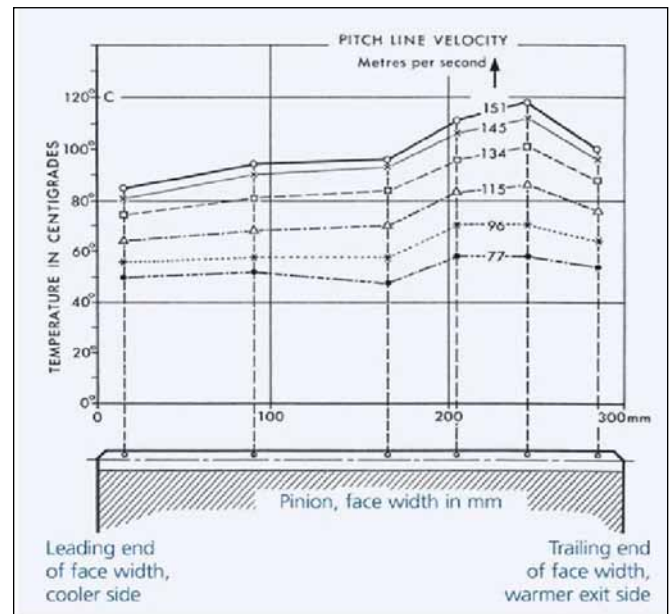

Figure 4—Effect of pitch-line velocity on tooth flank temperature and establishment of an asymmetrical speed/temperature gradient.



Figure 5—Varnish deposits on gear teeth.

ber of years. When a contact shift was observed, oftentimes heavy varnishing of the lubricant on the gear teeth in the vicinity of the contact face was noted in the area of the highest temperature gradient (Fig. 5).

This is also the area where the deepest correction is required (Fig. 6). The phenomena had been observed in both gear sets where the thermal corrections were nearly negligible, as well as in units with significant thermal corrections.

### Phenomena

In all cases upon inspection, the contact pattern on both the loaded and non-loaded flank exhibited a contact shift deviating from the originally designed tooth contact pattern. In some units the contact shift is more severe than others. If left unattended this contact shift of the intended-design contact pattern may progress, resulting in ever-increasing, locally high-loaded segments of the rotor flanks that may eventually result in gear failure.

### Case study—example of installation verifying longitudinal contact shift:

*Application: Driving: gas turbine (4,670 rpm)*

*Driven: centrifugal compressor (2,926.5 rpm)*

|          |                     |                           |
|----------|---------------------|---------------------------|
| $c-c$    | center distance     | = 580 mm (22.853 in)      |
| $B$      | face width          | = 500 mm (19.764 in)      |
| $\beta$  | helix angle         | = 10° (single-helical)    |
| $\alpha$ | pressure angle      | = 20°                     |
| --       | rotor material      | = carburizing alloy steel |
| $P$      | power               | = 37,285 kW (50,000 hp)   |
| $PLV$    | pitch-line velocity | = 109 m/s                 |
| $m$      | module              | = 9.25                    |

### Field Observations: Inspection After 12 Years and 105,000 Hours of Continuous Operation

**Dynamic:** After 105,000 hours the gear set showed no signs of tooth surface distress—i.e., scuffing, micropitting—and virtually no signs of pitting (a few pits were found on the dedendum of the pinion). Varnishing (on both pinion and wheel) was noted to be heaviest in the flank section with the deepest lead correction. However under observation it was readily noted that the “dynamic” load clearly favored the turbine end, and little or no load appeared to have been transmitted over the first ~150 mm of tooth face nearest the compressor end.

**Static:** The tooth contact pattern of the old rotors prior to removal was found to be in very poor condition and not in accordance with the original manufacturer’s protocol. The tooth contact was found to be heavy in the central-left portion of the tooth flank in a centralized area 100–175 mm from the pinion drive-end of the flank. In this region, contact was found to be symmetrical to the pitch line—as in distributed evenly along the profile—with equal load-sharing along the addendum and dedendum.

### Attempt to Correct in the Field

In this case the unloaded static tooth contact pattern of the drive flank was originally designed to be at the (NDE) compressor side of the mesh. After 12 years of continuous operation, this static pattern shifted toward the (DE) gas turbine side. Subsequently, the non-loaded tooth flank (originally



designed with an unmodified straight contact pattern) shifted toward the (NDE) compressor side.

An attempt was made in the field to correct the no-load static tooth contact by shifting the static contact toward the NDE of the pinion. Only a fractional improvement was realized—even with a relatively large adjustment. Improved contact was possible only if the longitudinal correction was no longer in accordance with the original specification. This had confirmed that the tooth form had become distorted with time.

On this basis a decision was made to replace the rotor set with an unused, spare set of rotors. The new rotors were installed and the no-load tooth contact was recorded and confirmed to be according to the original-configured protocol. An operational check of the new spare rotors (dynamic tooth contact) via inspection revealed full-load tooth contact after the operation reached steady-state conditions. The observed contact was 100% consistent across the entire tooth flank.

### Confirmation of Hypothesis

The old pinion and gear removed from service were placed on a lead- and profile-checking machine to determine the as-found lead and profile measurements. Figure 6 describes the original corrective values as made on the gear set-loaded tooth flanks prior to operation. Figure 7 describes the as-found, loaded-tooth-flank-measured values. Comparison of these figures demonstrates tooth flank expansion that shifted the original no-load, static contact pattern and provided obvious evidence of permanent deformation of the gear teeth.

Permanent deformation was also evident on the non-loaded tooth flanks (back side). Figures 8 and 9 provide a comparison of each rotor’s non-loaded tooth flanks showing the amount of change that took place for both the pinion and wheel.

The expansion is remarkable insofar as it has a magnitude of nearly 75% of the amount of the design lead modification.

### Theory as to Cause

During gear unit operation, there is a high-velocity axial flow of lube, oil and air across the helix (or helices) of the mesh. Through mesh engagement, oil and air are mixed and compressed, resulting in an asymmetrical (uneven) tooth flank temperature gradient (Fig. 4).

In the case study, highly localized temperatures had reached levels that caused a metallurgical transformation by which entrained austenite was transformed to martensite. This transformation resulted in an expansion of the case material, thereby affecting the tooth thickness, which in turn resulted in a contact pattern change on both the loaded and non-loaded flanks. The mechanism of expansion is due to the density difference between austenite and martensite. As noted in Figure 9, this expansion does not occur in a uniform manner since the temperature rise from the meshing action is asymmetrical over the tooth length.

Citing (D.W.) Dudley’s *Handbook of Practical Gear Design*: “After quenching, steels are usually tempered or stress-relieved. The tempering operation may be used to reduce the hardness of a part and increase the toughness. By

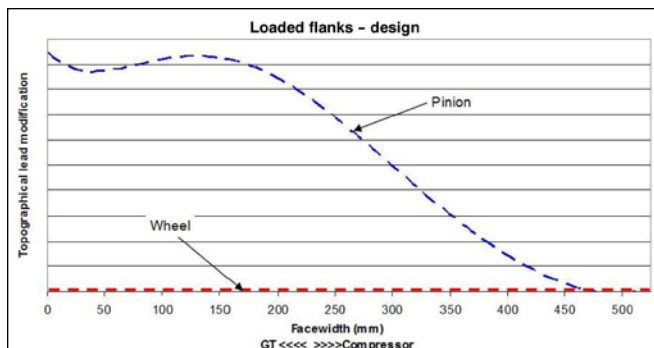

Figure 6—Original tooth modification plan (ordinate values intentionally omitted for proprietary reasons).

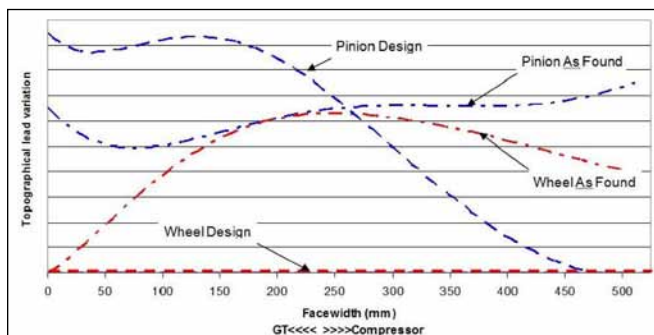

Figure 7—Loaded flank: design and as-found (ordinate values intentionally omitted for proprietary reasons).

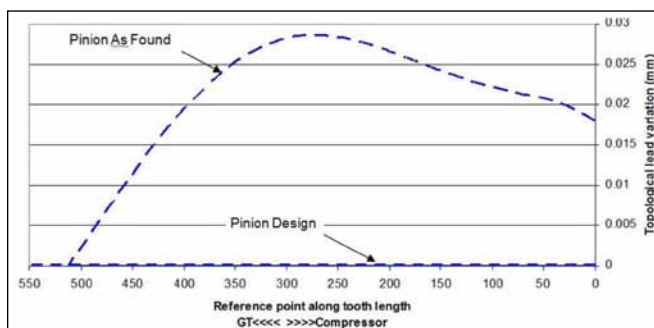

Figure 8—Pinion unloaded flank: design versus as-found.

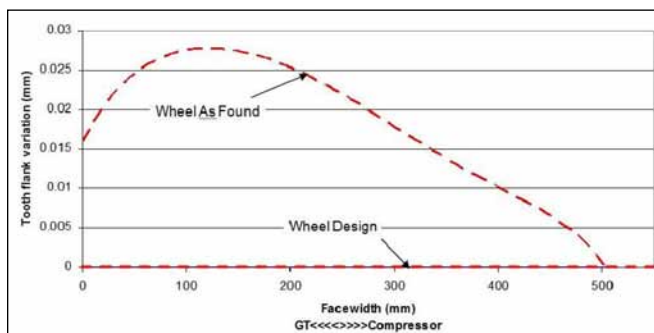

Figure 9—Wheel unloaded flank: design versus actual.

properly adjusting the tempering temperature, hardness values can be obtained over a wide range. Even when no reduction in hardness is desired a low-temperature (250–350 °F) tempering operation is desirable to reduce stresses in the steel and produce a kind of martensite that is tougher than the kind produced immediately upon quenching.”

This temperature range may be achievable in the operational environment of some running gear units.

Load conditions, partial loads vs. full load, tooth module and the level of operating stress numbers relative to gear tooth design may also have contributing influences. An improper design lead correction, manufacturing errors, an improperly set up gear tooth contact pattern during the original installation or changes due to uneven bearing wear or soft foot may also contribute to the described phenomena.

Considering the successful length of service in the noted example, it can be determined with certainty that the gear set was furnished with an optimized lead and, at the outset of service, the unit operated with uniform contact across the entire full face width of the teeth. As service time was accumulated, a segment of the tooth flank increased in temperature and reached the tempering temperature range. This most likely was the result of accumulated varnish staining of the gear teeth. Transformation occurred slowly at first and then increased at a faster rate, reducing flank contact over time. The appearance of significant varnishing of the gear teeth was the cause of this rise in tooth temperature.

**Varnishing does two bad things.** Varnish is an insulator on the gear teeth, thereby reducing the efficiency of the lube oil to cool them. As the varnish builds up, a worsening condition develops. As a result, the gear teeth will become hotter, thereby encouraging tempering of the gear teeth in that regime of the flank.

Varnishing increases the frictional effects of the compressed lube oil and air as they travel longitudinally across the flank, thereby adding additional heat to the tooth flanks.

Regardless of the means of entrainment, the action that leads to varnishing is in place. From here, the failure can proceed with adiabatic compression in the load zone of a lubrication system. Diabatic compression occurs when air bubbles travel from low pressure to high pressure. The air bubble compresses rapidly (implosion), resulting in intense entrainment of the heat and an extreme rise in temperature.

In this example, during the earlier years of service prior to the slow-developing tooth varnishing, the maximum temperature along the tooth length was most likely below the tempering temperature range. As varnish began to deposit on the gear teeth, the temperature gradient increased and gradually entered the tempering temperature range, thus beginning the process of transforming retained austenite to martensite and its attendant expansion. What was ultimately discovered was that the result of what may have occurred over a period of operation was not consistent in a linear sense with the running life of the gear set. In fact, the major transformation period likely started quite some time after the start of service and then changed rapidly— most likely in the last few years

of service. So while there had not been a failure, evidence of surface distress was beginning to develop; the small pitting located on the dedendum of the pinion indicated a failure may have been imminent and was caught in time. Inspection of the rotors revealed an increase in surface hardness of 3–4 Rc (original 58–59 Rc, now 61–62 Rc) as measured at various points on several gear teeth. This is the result of un-tempered martensite transformed from retained austenite. While the transformed surface is harder than the earlier starting condition, it could not possibly sustain the load over such a narrow portion of the face for very much longer. Considering the locally high loads, no additional surface distress was observed, such as more pitting or scuffing. We attributed this to the improved surface condition over running time.

It was reported to us that a small increase in hardness has been observed on many high-speed gear sets inspected after years of running without any measured shift in the contact pattern (hence no expansion of the gear set teeth). We conclude such gears were at the early stages of transformation and/or the retained austenite was less than the reported case study.

It has been observed that even with properly applied design corrections (i.e., correctly designed and manufactured tooth lead, as well as proper alignment in the field) that result in more uniform and distributed longitudinal load, it is not enough to assure this phenomenon can be avoided. From all indications, it would appear this application had an effective lead correction based on the dynamic tooth contact check after commissioning. It is believed that this gear did not varnish or temper for some time, considering the number of load cycles (operating hours). Rather, the high-temperature gradient segment of the gear tooth inclined to reach the highest operating temperatures was mostly responsible for inducing the highest stress on the lube oil film. This in turn began the varnish deposit on the gear flanks, inducing the material transformation.

### Solutions Based on Presented Theory

Consideration is given as follows:

Provide sufficient lubrication for mesh cooling, as this is essential to avoid the tempering effect.

Utilize lube oil with a high resistance against oxidizing under load and, if possible, change routinely (every 25,000 hours).

Install improved filtration systems that reduce or even eliminate varnish deposits. Electrostatic filtration is reputedly a method for treating the problem. With oils of relatively low viscosities, a considerable amount of the sub-micron resinous material can be stripped out of the oil using charged particle separators. Also known as electrostatic filters or precipitators, these units separate carbon and oxidized particles by field-induced electromechanical forces (charges) on polar carbon and oxide insolubles. The charged suspensions precipitate to the collection media or plates of the opposite charge, to which they adhere tightly.

Avoid too much retained austenite in the rotors in heat treat at the time of manufacture; there is a diminishing set of returns in transformation of austenite to martensite. Rotors with 30% retained austenite should be re-tempered. Sufficient iterations of tempering may be required. While care is needed to avoid too much loss in hardness, cold treatment may provide a suitable method after temper and quenching.

Some retained austenite is desirable for good gearing. A recommended target of maximum 20% is advised to minimize the transformation effects during operation. With routine inspections, small amounts of operational transformation can be addressed in the field by small adjustments in the tooth contact. (*Authors' note: Many of the gear units inspected with high operational hours but without evidence of tooth pattern creep are credited with gear rotors where retrained austenite had been properly controlled to lower percent levels. This document reports longitudinal tooth contact pattern shift of high-speed gears caused by an asymmetrical expansion of the rotor teeth width. It reports the mechanical consequences of such phenomena and measures that if implemented may prevent the phenomena. It is not a metallurgical report and therefore does not explain how to effectively limit the amount of retained austenite in carburized rotor forgings.*)

Deepen the lead correction in the region of the highest temperature gradient, particularly for wide face width gears and gears with high PLVs (pitch-line velocities). While this may not be the optimum lead correction, it eases the stress on the lube oil film as it is squeezed through the mesh in the hottest section of the flank, thereby reducing the tendency of varnished particles adhering to the gear teeth in that regime. It will not, however, appreciably change the heat gradient or shift the hot section. For existing gear sets in operation where the tooth expansion has occurred and regrinding is possible, it is reported a deeper correction may benefit potential, continued expansion of the gear set rotor over time. Added life expectancy, rotor condition and operating environment need to be evaluated in determining corrective action.

Super-finishing reputedly can significantly reduce the quenching losses in the mesh by reducing the coefficient of friction along the line of contact. In the convergent zone ahead of the contact area, the sliding component wipes the lubricant sideways over the tooth flanks as the lube oil rapidly travels longitudinally across the tooth flanks.

Encourage periodic shutdown inspections, allowing the gear teeth to be cleaned of any varnish deposits according to the manufacturer's recommendations. 

## References

1. Amendola, J.B. "Defeating Tooth Flank Deformation," *Gear Solutions*, June 2006.
2. Amendola, J.B. "Lead Correction Derivation Method for High-Capacity Turbo-Gears with High-Pitch Line Velocities for Both Single- and Double-Helical Gears," March 2008.
3. Amendola, J.B. III. Field Service Report, August 31, 2010, Unpublished.
4. Dudley, D.W. *Handbook of Practical Gear Design*, CRC Press, 1994, Sect. 4.10–4.11.
5. Pirro, D.M. and A.A. Wessol. *Lubrication Fundamentals*, Marcel Dekker, 2nd Edition, 2001, pp. 211–216.
6. Fitch, J. "Using Oil Analysis to Control Varnish and Sludge," *Machinery Lubrication*, 2010.
7. MAAG. *MAAG Gear Book*, January, 1990, pp. 185–186.
8. MAAG. Tooth Flank Modifications, 1000.09.03.
9. Martinaglia, L. "Thermal Behavior of High-Speed Gears and Tooth Corrections for Such Gears," October 1972, *AGMA FTM*, San Francisco, CA.
10. Swiglo, A. "Principal Associated with Size Changes in Carburized Steel," Artec Machine Systems, January 12, 2011, Unpublished.

**John B. Amendola** holds a 1964 Bachelor Mechanical Engineering degree from Villanova University and a Master Degree from Brooklyn Polytechnic in 1971. He founded Artec in 1972 and held a long relationship with MAAG Gear until their closing. Amendola is active on the AGMA TDEC, serves on AGMA technical committees and is chairman of the HS Committee.

**John B. Amendola III, P.E.**, received his Bachelor Marine Engineering degree in 1982 from the Maine Maritime Academy. He served in the U.S. Navy for four years in Europe and the Atlantic fleet before working in merchant shipping—SUNY Maritime, on board the *Empire State*—and then joining MAAG Gear AG Zurich. Amendola joined Artec in 1993. He is a commander in the USN Active Reserve and is an active AGMA technical committee member.

**Dereck Yatzook** received his Bachelor of Science Mechanical Engineering degree in 2004 from the University of New Haven. He joined Artec in 2002 as an apprentice and gained full employment there in 2004. Yatzook is an active AGMA technical committee member.