

# gear

TECHNOLOGY®

MAY  
2015

## UNLOCKING THE SECRETS OF THE UNIVERSE

WE EXPLORE THE  
LATEST IN NVH  
ANALYSIS SOFTWARE





# Solutions for all your gear cutting tool needs

## Gear cutting tools and services

Star SU offers a wide variety of gear cutting tools and services, including:

- Gear hobs
- Milling cutters
- Indexable Gear Milling Solutions by Sandvik Coromant
- Shaper cutters
- Scudding® and Power Skiving cutters
- Shaving cutters
- Chamfer and deburring tools

- Rack and saw cutters
- Master gears
- Ring and plug gauges
- Advanced coatings including Alcrona Pro
- Tool re-sharpening

## Total tool life cycle management

Control your tool costs and let Star SU manage your tool room. From new tools to design work to re-sharpening and recoating, we have the equipment and resources to help keep your gear cutting operation running smoothly.



SAMPUTENSILI



Phone: 847-649-1450

5200 Prairie Stone Pkwy. • Ste. 100 • Hoffman Estates • IL 60192



PTG-1



GS 400

## Affordable hob sharpening and in-house tool maintenance

Star's PTG-1 sharpens both straight and spiral gash hob designs up to 8" OD x 10" OAL. Additionally, it sharpens disk, shank and helical type shaper cutters and a wide range of round tools, making it a versatile tool room machine.

## Shaving cutter and master gear grinding

Designed to grind shaving cutters and master gears, the GS 400 sets new standards for precision, reliability and ease of use. An integrated measuring unit automatically checks the quality of the first tooth ground without unclamping the workpiece.

**BOURN  
& KOCH**  
INC

**FFG**  
EUROPE

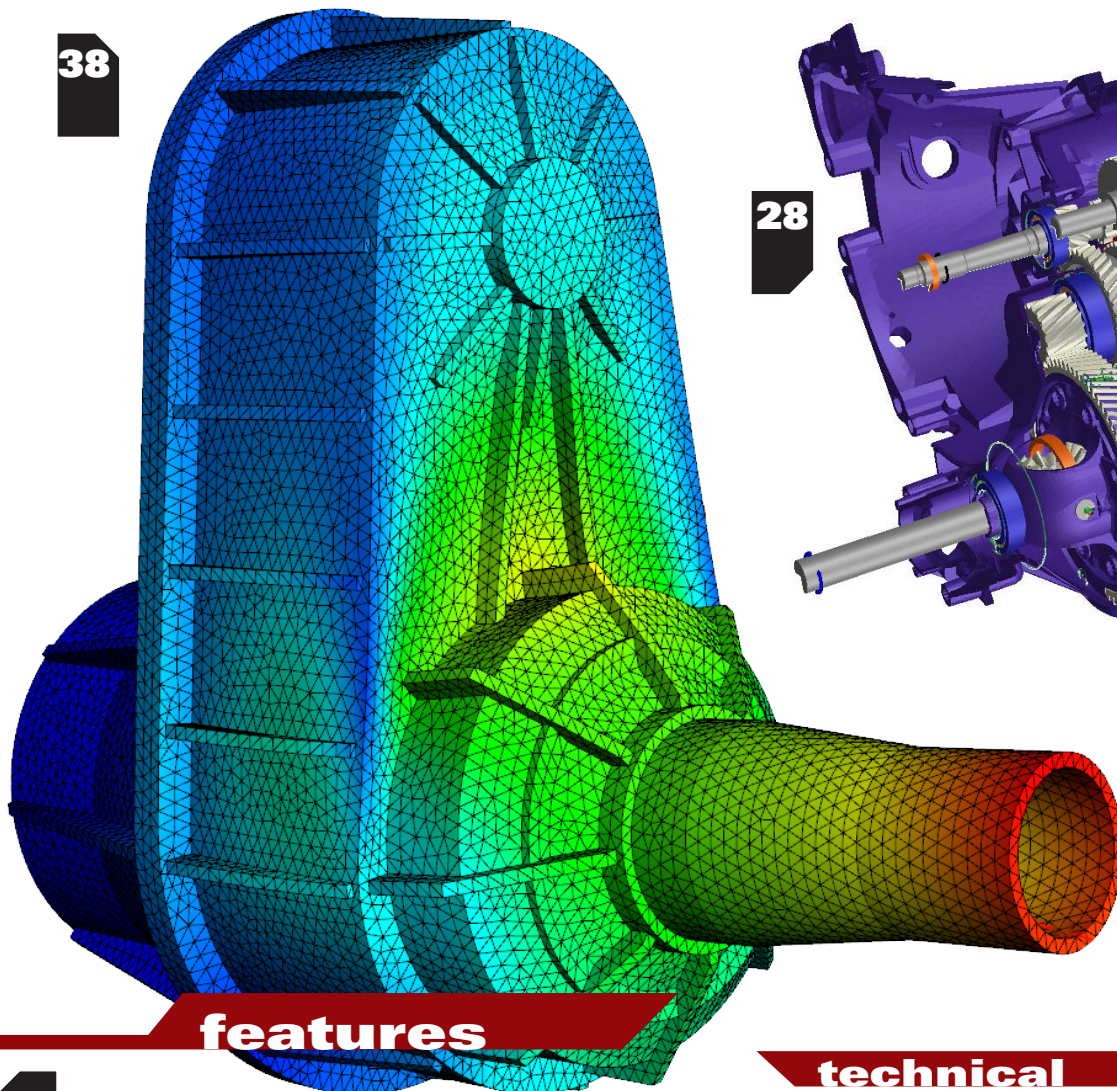
**SANDVIK**  
Coromant



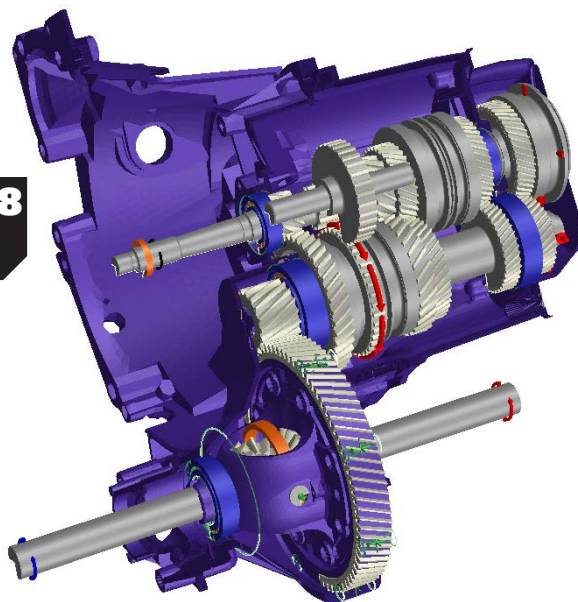
[www.star-su.com](http://www.star-su.com)



38



28



## features

### 22 Times Aren't A-Changin' for Broaching — and that's Just Fine

Broaching technology may be old. It's also irreplaceable.

### 28 NVH Analysis within the Design Process

Software making a fine mesh of things.

### 38 Integrated Software Solutions for Troubleshooting Gear Whine

Gear whine analysis requires a system-level approach.

## technical

### 46 Ask the Expert

Gear pairs: setting and checking for mesh.

### 48 Surface Roughness Measurements of Cylindrical & Bevel Gears on Gear Inspection Machines

Addressing roughness measurement systems on tooth flanks.

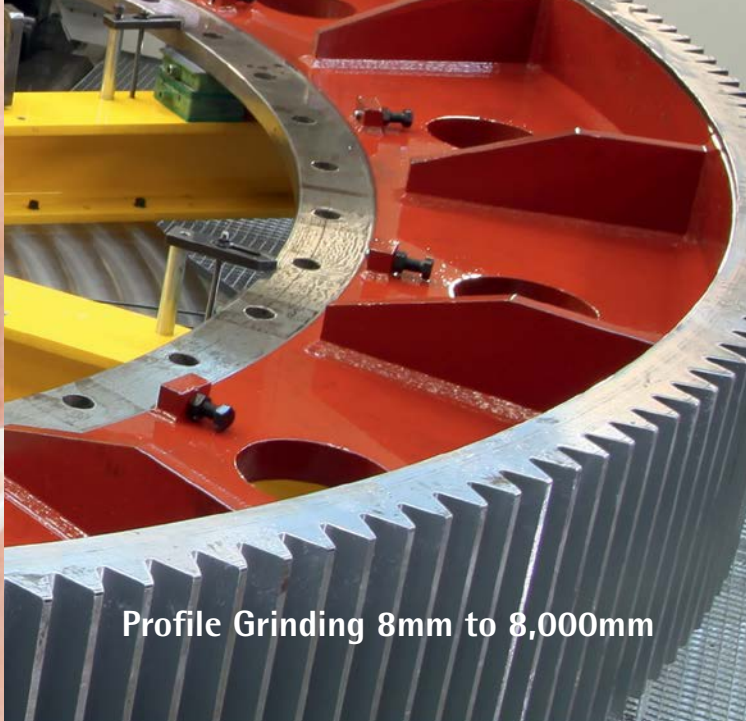
### 56 Hypoid Gears with Involute Teeth

An overview of face cutting techniques prevalent in hypoid gear fabrication is presented.





Generating Grinding 8mm to 1,250mm



Profile Grinding 8mm to 8,000mm

# Handling all your grinding needs... the Smallest and the Largest.



## KAPP KX 100 DYNAMIC

A machine so small you could keep it  
in your garage (really)



## NILES ZP 80

A machine so large you could park a Cessna Skyhawk in it. (really)

KAPP Technologies  
2870 Wilderness Place Boulder, CO 80301  
Phone: (303) 447-1130 Fax: (303) 447-1131



[www.kapp-niles.com](http://www.kapp-niles.com) [info-usa@kapp-niles.com](mailto:info-usa@kapp-niles.com)

# gear

TECHNOLOGY Vol. 32, No. 3




## departments

- 06 GT Extras**  
*A smarter geartechnology.com.*
- 09 Publisher's Page**  
I'm surprised that you're surprised.
- 10 Product News**  
Gleason launches analytical gear inspection system; Kluber intros synthetic grease for extreme conditions.
- 62 Industry News**  
Klingelberg partners with Sandvik Coromant for tool concept project; Rick Falgiatano appointed Star SU vice president of cutting tool sales.
- 68 Calendar of Events**
  - June 15-17:** Western Manufacturing Technology Show (WMTS), Edmonton EXPO Centre, Edmonton, Alberta, Canada
  - June 23-24:** Liebherr Gear Seminar, Ingersoll Cutting Tools, Rockford, IL
- 70 Advertiser Index**  
How and where to reach every advertiser in this issue.
- 71 Classifieds**  
Our products and services marketplace.
- 72 Addendum**  
"A Founding Father of Machine Tool Technology."



**GEAR CUTTING TOOLS**

**MADE IN SWITZERLAND**

**SCHNYDER** US Distributor  
**HANIK CORPORATION**

GEAR CUTTING SOLUTIONS PHONE 630-595-7333  
FAX 630-595-7343  
www.hanikcorp.com email: hanikcorp@aol.com

**60 YEARS OF TOP TECHNOLOGY**

ph: 011-41-32-344-0400 • fax: 011-41-32-344-0404 • www.schnyder.com • mail@schnyder.com

www.framo-morat.com

Made in Germany

Precision Gear Technology

Metal or plastics - we are your reliable partner for customized gear engineering & drive solutions.








Local support in New Mexico, USA  
usa@framo-morat.com ▪ #800-956-6728

 **FramoMorat**  
Franz Morat Group



# New shaping head creates more possibilities.

## Performance and precision with electronic helical guide.

The compact shaping head SKE 120 for the shaping machines LSE 200 – 1600 increases production flexibility. Without changing the shaping guide, this shaping head version is able to machine a large variety of different parts.

- Controlled lead guide for spur and helical gears
- Stroke adjustment range 650 mm
- Shaping spindle with hydrostatic bearings and guide
- Option of helix angle corrections
- Easy workpiece change and short setup times
- 1200 double strokes per minute
- Gears up to module 8 mm
- Stroke length 120 mm



Liebherr Gear Technology, Inc.  
1465 Woodland Drive  
Saline, Michigan 48176-1259  
Phone.: +1 734 429 72 25  
E-mail: info.lgt@liebherr.com  
[www.liebherr.com](http://www.liebherr.com)

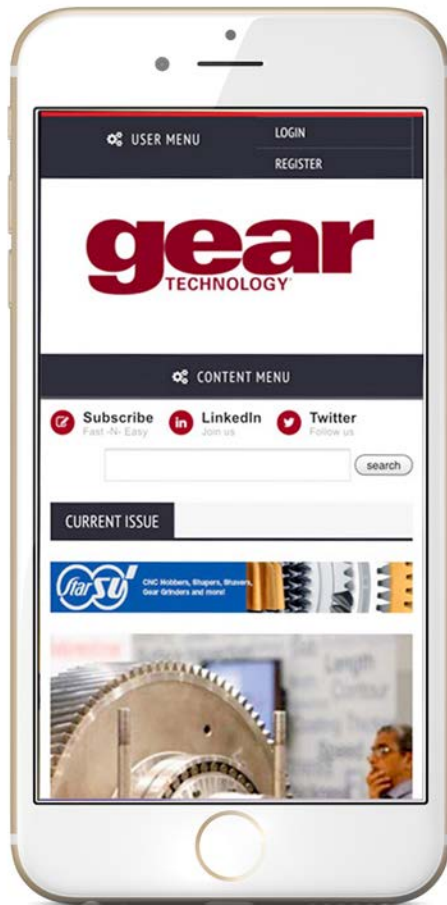
# LIEBHERR

The Group

THE GEAR INDUSTRY'S INFORMATION SOURCE

www.geartechnology.com

A **SMARTER**  
Geartechnology.com



We've created a cleaner, sleeker more user-friendly online experience by completely redesigning the Gear Technology website. Go to [www.geartechnology.com](http://www.geartechnology.com) to see how much easier it is to find what you're looking for!

As part of the redesign, we'll be including some "FEATURED TOPICS" on the home page each month. It's our way of bringing to your attention all the great articles in our 31-year archive. This month's featured topics are "Hobbing" and "Basics"

<p><b>HOBBIING</b> MORE ON HOBBIING +</p> <p>Simulation of Deviations in Hobbing and Generation Grinding</p> <p>The hobbing and generation grinding production processes are complex due to tool geometry and kinema...</p> <p><b>Hob Tool Life Technology Update</b> March/April 2009 Hob Tool Life Technology Update</p> <p><b>An Innovative Way of Designing Gear Hobbing Processes</b> May 2012 F. Kloocke, C. Gergels, R. Schalaster and A. Stuckenberg</p> <p><b>Full Speed Ahead</b> May 2012 Matthew Jaster</p> <p><b>Comparison of PM-HSS and Cemented Carbide Tools in High-Speed Gear Hobbing</b> September/October 2009 Fritz Kloocke, Philipp Kauffmann, Ralf Schalaster and Arne Stuckenberg</p>	<p><b>BASICS</b> MORE ON BASICS +</p> <p>Operating Pressure Angle</p> <p>What is the difference between pressure angle and operating pressure angle ...</p> <p><b>The Process of Gear Shaving</b> January/February 1986 John P. Dugges</p> <p><b>Worm Gears - Ask the Expert</b> October 2013 Joe Mihelick, Charles D. Schultz, Hermann Stadtfeld</p> <p><b>Importance of Contact Pattern in Assembly of Bevel vs Cylindrical Gears</b> August 2014 Hermann J. Stadtfeld</p> <p><b>The Pros and Cons of Fully Ground Root Fillets</b> August 2014 Robert L. Errichello</p>
--	--

# gear TECHNOLOGY

RANDALL PUBLICATIONS LLC  
1840 JARVIS AVENUE  
ELK GROVE VILLAGE, IL 60007

(847) 437-6604  
FAX: (847) 437-6618

**EDITORIAL**

**Publisher & Editor-in-Chief**  
Michael Goldstein  
[publisher@geartechnology.com](mailto:publisher@geartechnology.com)

**Associate Publisher & Managing Editor**  
Randy Stott  
[wrs@geartechnology.com](mailto:wrs@geartechnology.com)

**Senior Editor**  
Jack McGuinn  
[jmcguinn@geartechnology.com](mailto:jmcguinn@geartechnology.com)

**Assistant Editor**  
Erik Schmidt  
[erik@geartechnology.com](mailto:erik@geartechnology.com)

**Editorial Consultant**  
Paul R. Goldstein

**Technical Editors**  
William (Bill) Bradley, Robert Errichello, Octave Labath, P.E., John Lange, Joseph Mihelick, Charles D. Schultz, P.E., Robert E. Smith, Mike Tennutti, Frank Uherek

**DESIGN**

**Art Director**  
David Ropinski  
[dropinski@geartechnology.com](mailto:dropinski@geartechnology.com)

**ADVERTISING**

**Associate Publisher & Advertising Sales Manager**  
Dave Friedman  
[dave@geartechnology.com](mailto:dave@geartechnology.com)

**Materials Coordinator**  
Dorothy Fiandaca  
[dee@randallpublications.com](mailto:dee@randallpublications.com)

**China Sales Agent**  
Eric Wu  
Eastco Industry Co., Ltd.  
Tel: (86)(21) 52305107  
Fax: (86)(21) 52305106  
Cell: (86) 13817160576  
[eric.wu@eastcotec.com](mailto:eric.wu@eastcotec.com)

**ON-LINE**

**Digital Content Manager**  
Kirk Sturgulewski  
[kirk@geartechnology.com](mailto:kirk@geartechnology.com)

**CIRCULATION**

**Circulation Manager**  
Carol Tratar  
[subscribe@geartechnology.com](mailto:subscribe@geartechnology.com)

**Circulation Coordinator**  
Barbara Novak  
[bnovak@geartechnology.com](mailto:bnovak@geartechnology.com)

**RANDALL STAFF**

**President**  
Michael Goldstein

**Accounting**  
Luann Harrold





# For the Last 60 Years, We've Never Stopped Learning

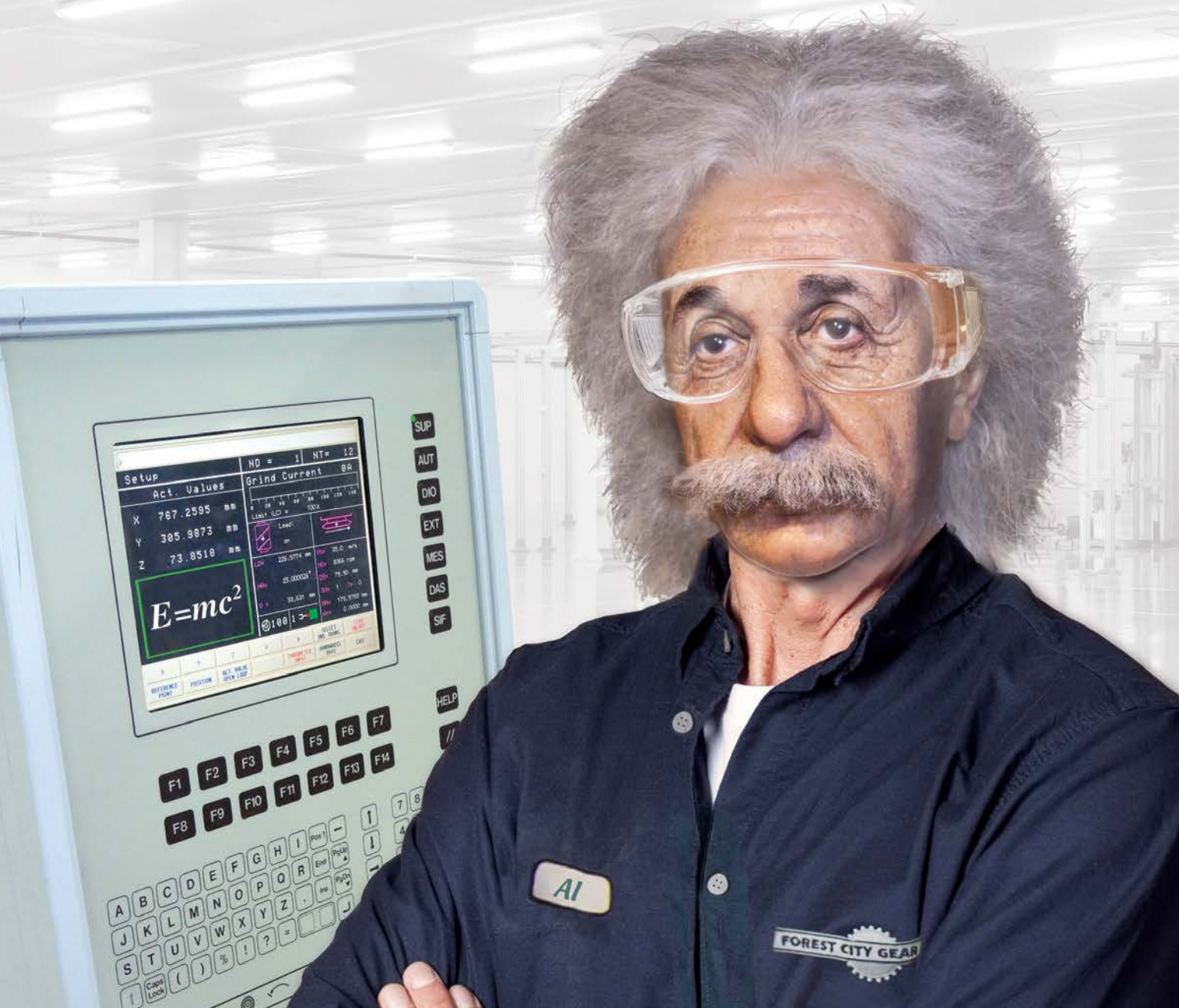
Searching for a higher gear-producing IQ? Make the smart choice today.

Your trusted source for



**FOREST CITY GEAR**

11715 Main Street, Roscoe, IL 61073  
815-623-2168  
[www.forestcitygear.com](http://www.forestcitygear.com)



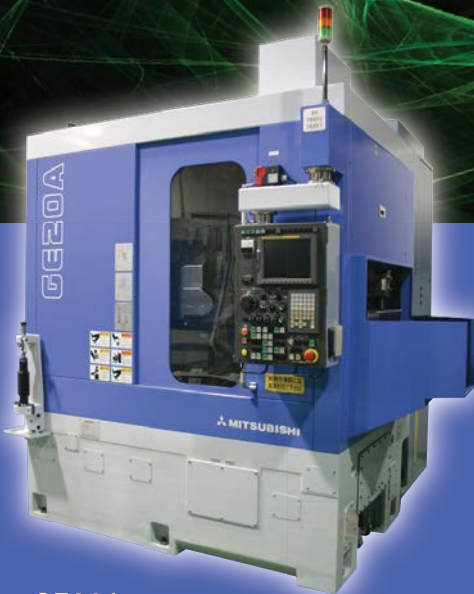




**MITSUBISHI**  
HEAVY INDUSTRIES AMERICA, INC.

Our Technologies, Your Tomorrow

# The Advantage of **Supreme** Productivity



GE20A  
**GE**series

## The Game-Changing Mitsubishi GE Series CNC Gear Hobbing Machines.

A quick glance at Mitsubishi's GE Series Gear hobbing machine doesn't reveal the truth behind its real power. However, when you evaluate the output the full picture is dramatic and clear. With an all new, ultra-efficient dry cutting design, the GE series machines produce gears up to 50% faster than previous technologies—with all the precision your specifications demand. This kind of boost in productivity is sure to help you be more competitive in the marketplace and pump up your profits. Experience the world-class performance of the GE series hobbing machines at [www.mitsubishigearcenter.com](http://www.mitsubishigearcenter.com) or contact sales at 248-669-6136.





# I'm Surprised that You're Surprised

**I've just come back from the AGMA annual meeting in Napa, California, where I had a great time visiting with friends and colleagues in the gear industry.** As always, the annual meeting was a great opportunity to network and meet with other AGMA members.

I enjoy these meetings, as they allow me to catch up with many of the people I've done business with over the years—both as a machine tool dealer and as publisher of *Gear Technology*. In many ways, going to these meetings is like going home. Everyone is familiar with everyone, and you can pick up on conversations that began decades ago.

Naturally, *Gear Technology* has a lot of fans in that environment. I almost always come home with a few “ataboys” and pats on the back for the work we've done over the years. This issue marks our 31<sup>st</sup> anniversary, and many of the people who attend AGMA's annual meeting have been reading *Gear Technology* since it began in 1984. They all know about our dedication to publishing the most relevant, accurate and up to date information available on gear manufacturing. They know we're unique in the industry in that we are gear people that got into publishing, not the other way around. They also know we have a crew of technical editors who are the knowledgeable giants in the industry, who help us by checking the accuracy and relevance of our technical articles before they're published.

Every once in a while, I am surprised to learn that even among our biggest fans, readers often aren't aware of the ways *Gear Technology* has changed and grown over the years. Sure, they know us for our technical articles, and they value the credibility we offer. At this year's meeting, I sat down with a colleague who has been a long-time reader of *Gear Technology*. This is a reader who has saved every issue of the magazine—since the beginning—as part of his personal gear library. He's definitely a fan, but his idea of who we are today and what *Gear Technology* represents was perhaps a little dated. When he and I got to talking about *geartechnology.com* and how all of our technical articles are available for free online, he was quite impressed.

“I didn't know you did that,” my friend told me.

I was surprised that he was surprised. But I guess I shouldn't be. Those of you who have known me for a long time—or who are long-time readers of this column—have probably heard one



**Publisher & Editor-in-Chief**  
Michael Goldstein

of my favorite sayings: “Being good at something and not telling anyone is like winking in the dark. You know what you're doing, but nobody else does.”

Even though I know we make an effort to publicize the capabilities of our website, I realize now that maybe we've been winking in the dark.

So I'm going to take this opportunity to explain it to you. Go to our website. Find the search box (it's at the top of every page). Type something—anything—in the box. Say you want to find articles on bevel gears, the involute curve or ISO 6336. Just type in what you're looking for and the archive will give you a list of relevant matches from our 31-year publishing history.

I've talked to a number of gear engineers who use this feature regularly, so I know it's valuable. But only if you know it's there.

We've recently completed a major redesign of the website in an effort to make it easier to use, no matter what size screen you're looking at. Everything automatically resizes to fit your screen even if you're surfing on a cell phone. Another major feature of the new design takes place behind the scenes. When you find something on our site that interests you, you'll now find related articles and news items just a click away. All of our content is connected via keywords and subject focus areas. We hope this makes it even easier than ever for you to find the gear-related content that's relevant to you.

So here I am, winking in plain view. That's your cue to go to the website and explore. We'd love to know what you think. And you might be surprised at how much information is really at your fingertips.

# Gleason

## INTRODUCES 300GMSP ANALYTICAL GEAR INSPECTION SYSTEM

Gleason Corporation recently introduced its latest gear metrology innovation at the Control Show in Stuttgart, Germany, on May 5.

The 300GMSP Analytical Gear Inspection System is designed to operate in production environments while yielding reliable measurement results, with integrated systems designed to compensate for the typical production floor thermal, vibratory and contamination dynamics that normally compromise the performance of metrology systems.

A patent-pending base design includes a leveling system to attenuate a broad spectrum of normal production environment vibrations, yielding measurement values in parallel with those achieved in controlled calibration laboratories, but without the delay of having to move to the lab location.

Thermal fluctuations normally associated with shop floor environments are proactively compensated for, allowing for reliable inspection results. The system identifies and applies a compensation for factory floor influences in real time.

The 300GMSP Analytical Gear Inspection System is designed and tested to perform as a turn-key gear inspection system in the manufacturing environment, and is the solution to gear inspec-

tion for today's applications in aerospace, automotive, and smaller power transmission industries.

This latest addition to the GMS Series (with models available for gears up to 3,000 mm in diameter) includes features like surface finish measurement and prismatic feature measurement. It is also included the Gleason GAMA 3.0 applications software suite which, like its GAMA 2.0 predecessor, offers users an intuitive user interface and simple input screens for programming of workpiece and cutting tool data. GAMA 3.0 also includes tutorial information on the gear features with verbiage, pictures and videos that are user editable.

The 300GMS P is equipped with a new ergonomically mounted operator workstation and an Advanced Operator Interface—both designed to improve the operator's effectiveness at every stage of the inspection process.

The Advanced Operator Interface puts a number of tools right at the opera-

tor's fingertips, including an environmental monitoring station to record temperature and humidity as well as video telephony, note pad and voice mail messaging capability, Gleason Connect for enhanced remote diagnostic support, creation of standard work instructions, online training tools, multi-lingual communication and more.

### For more information:

Gleason Corporation  
Phone: (585) 473-1000  
[www.gleason.com](http://www.gleason.com)



# Klüber Lubrication

## INTRODUCES SYNTHETIC GREASE FOR EXTREME CLIMATIC CONDITIONS

Klüber Lubrication recently introduced Klübersynth EM 94-102, a fully synthetic lubricating grease incorporating a calcium complex soap thickener. The thickener enables formation of a resil-

ient lubricating film that provides high resistance to mechanical-dynamic loads while enabling wear protection.

Klübersynth EM 94-102 can be used in a variety of applications under different climatic conditions due to its wide service temperature range. As a result, various friction points can be supplied with one single lubricant, avoiding confusion due to multiple lubricant selection and use.

The resistance to water and corrosion pro-

tection properties of Klübersynth EM 94-102 make it suitable for use in wet and humid areas. Examples include rolling and plain bearings for winter sport applications, like ski lift equipment and snow grooming vehicles, or industrial offshore and marine applications.

Klübersynth EM 94-102 is suitable for an array of applications because of its wear protection, adhesion characteristics, load capacity and low-temperature behavior.

### For more information:

Klüber Lubrication North America L.P.  
Phone: (603) 647-4104  
[www.klubersolutions.com](http://www.klubersolutions.com)





# Batch Furnace System – Single-Chain Model



# ATLAS

## Video Brochure

Ipsen's ATLAS atmosphere furnace line, which is manufactured and serviced in the USA, combines the achievements of past atmosphere furnaces with the evolutionary innovations of the future. This video showcases the single-chain model's features, benefits and technological advantages, including:

- Load size of 36" x 48" x 38" (W x L x H)
- Improved functionality and precision of the quenching system – TurboQuench™
- Intelligent controls with predictive process capabilities – Carb-o-Prof®

Call Our Sales Team

**800-727-7625**

International: +1-815-332-2695

Ask for Rene, ext. 2695

Scan the QR code to view the video:



or visit

[IpsenUSA.com/ATLAS-Video-Brochure](http://IpsenUSA.com/ATLAS-Video-Brochure)



# Mesys

## SHAFT SYSTEM SOFTWARE OFFERS ADVANTAGES FOR GEARBOXES

The Mesys shaft and bearing calculation software is mainly purposed for bearing analysis, but it also offers advantages for gearbox manufacturers.

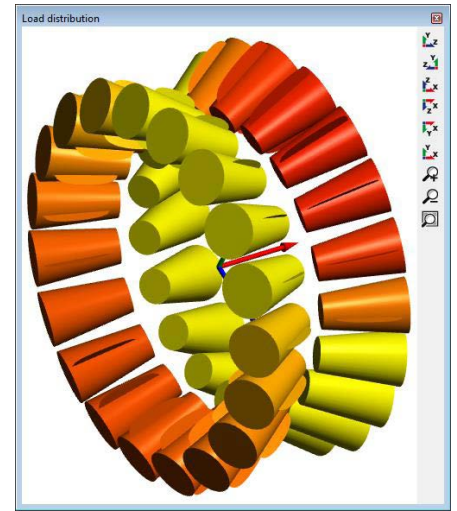
The Mesys shaft system calculations allow the definition of shaft systems coupled by gears and bearings. Cylindrical gear pairs, planetary stages, bevel and worm gears are supported. The software includes rating for bearings and shafts, but no gear calculations. Instead, interfaces to several gear calculation programs are available. Currently interfaces are available to GWJ eAssistant, Hexagon ZARI+, KISSsoft, Dontyne GPS and TBK 2014.

Shaft geometry with loading and supports can be defined for each shaft; gear connections and rules for positioning can be defined and load spectra can be considered. The result overview at the bottom of the program shows bearing life, bearing contact stress, flank and root safety for the gears and safety factors for shaft strength.

Gear connections can be defined by selecting two gears. This information is then also used for positioning. The integration of gear calculation programs is different. The web based eAssistant by GWJ Technology is directly integrated into the user interface and is shown if a gear pair is selected. For other programs an additional window is shown. All gear calculation data is saved with the shaft systems.

For the calculation of the load distribution the shafts are considered as Timoshenko beam elements and the deformation of the teeth are taken into account using the gear mesh stiffness, which can be taken from the gear calculation. As the calculation considers the shaft system, deformations of both shafts are taken into account. Bearing stiffness is considered, housing stiffness matrices could be considered too, if available.

In version 04/2015 an automatic parameter variation is added to the software. This parameter variation is best



used to analyze results dependent on one or two parameters. Unfortunately, many parameters have tolerances. This could be addressed by using the statistical version of the parameter variation. This allows many parameters to vary within ranges and a given distribution.

### For more information:

Mesys AG  
Phone: 41 44 455 68 00  
[www.mesys.ch](http://www.mesys.ch)



# Pioneering China Gear Manufacturing











**ZHENGZHOU RESEARCH INSTITUTE OF MECHANICAL ENGINEERING**

NO. 81 Songshan South Road, Zhengzhou, Henan 450052, China | Tel: 86 371-67710564 | Fax: 86 371-67710565 | Web: [www.zrime.com.cn](http://www.zrime.com.cn) | Email: [cheny@zrime.com.cn](mailto:cheny@zrime.com.cn)





# Seco

## UNVEILS LATEST EVOLUTION IN DURATOMIC TECHNOLOGY WITH THREE NEW GRADES FOR TURNING STEEL

With the unveiling of its next-generation Duratomic Technology, Seco Tools, LLC recently introduced three new turning insert grades that achieve the balance of toughness and hardness when machining steel alloys and other work-piece materials such as cast irons and stainless steels.

The new TP2501, TP1501 and TP0501 represent an expansion of the Duratomic technology introduced by Seco in 2007, which was the industry's first textured, a-based Al<sub>2</sub>O<sub>3</sub> coating. The Duratomic CVD aluminium-oxide coating process manipulates coating components at an atomic level to achieve improved mechanical and thermal properties and enhance performance.

The TP2501, TP1501 and TP0501 combine the benefits of aluminum-oxide coatings with specially developed compositions of the tools' bulk substrates and cobalt-enriched zones. Modifications of those elements make

the new grades both tougher and more wear resistant. According to Seco, the latest Duratomic technology used in TP2501, TP1501 and TP0501 improves productivity by at least 20% in average turning applications as compared with the original TP2500, TP1500 and TP0500 grades.

In addition to achieving the toughness and hardness balance, the new inserts incorporate Edge Intelligence, a used-edge detection technology. The insert surfaces feature an approximately

0.1µm-thick chrome-colored coating. Black aluminum oxide showing through the chrome-colored coating identifies a used insert edge and allows operators on shop floors to spot them. Also, key to Edge Intelligence is that its high-contrast used-edge marks do not impact tool performance or machining-related parameters such as cutting data. As a result, manufacturers can process more parts per edge, limit production interruptions and reduce waste.



## All The Gear Cutting Tools You Will Ever Need Are Right Here DTR is one of the world's largest producers.

### DTR. Your best choice for high quality gear cutting tools.

DTR is a world class supplier of the finest high performance long-life gear manufacturing tools, for small and large gear cutting applications. Established in 1976, we are one of the world's largest producers of cutting tools, shipping to over 20 countries.

DTR offers a full line of gear cutting tools including:

- Hobs
- Carbide Hobs
- Shaper Cutters
- Milling Cutters
- Chamfering and Deburring Tools
- Broaches
- Master Gears

We can produce virtually any tool you need for auto, aerospace, wind, mining, construction and other industrial gears.

Every tool is precision-made utilizing high speed steel, premium powder metal or carbide and the latest in coatings, to achieve superior cutting and long life. DTR uses top of the line equipment including Reischauer CNC grinders and Klingelnberg CNC sharpeners and inspection equipment.

Learn more about our outstanding quality tools at [www.dragon.co.kr](http://www.dragon.co.kr).

Call us at 847-375-8892 for your local sales representative or  
Email [alex@dragon.co.kr](mailto:alex@dragon.co.kr) for a quotation.



# DTOR

PERFECTION MOVES US

(formerly Dragon Precision Tools)

[WWW.DRAGON.CO.KR](http://WWW.DRAGON.CO.KR)

**DTR has sales territories available. Call for more information.**

**U.S. Office Location (Chicago)**

**Email inquiries to:** [alex@dragon.co.kr](mailto:alex@dragon.co.kr)

1865A Hicks Road, Rolling Meadows, IL 60008

**PHONE:** 847-375-8892 **Fax:** 224-220-1311

Headquarters

36B-11L, Namdong Industrial Complex, Namdong-Gu, Incheon, Korea

**PHONE:** +82.32.814.1540

**FAX:** +82.32.814.5381

TP2501, TP1501 and TP0501 are available in a range of insert sizes and geometries to accommodate everything from roughing to finishing operations. Plus, the three grades' application areas overlap, resulting in a seamless progression, without gaps, from inserts engineered to reliably handle a wide range of general applications at moderate cutting speeds through tools that permit process optimization with higher parameters.

TP2501 is a versatile grade with secure edge toughness behavior that brings reli-

able part production to general steel turning applications. TP1501 is a general grade with well-balanced properties that make it suitable for applications requiring high wear resistance in low-alloy steel workpieces.

TP0501 is a general grade suited for stable machining conditions and situations requiring high output. Of the new TP grades, it provides the highest possible wear resistance and/or cutting speeds in high-alloy and abrasive steel turning applications.

**For more information:**

Seco Tools, LLC.  
Phone: (248) 528-5444  
[www.secotools.com/us](http://www.secotools.com/us)

**NPI**

**INTRODUCES MODEL 450 SLIDING-JAW AIR CHUCK**

Northfield Precision Instrument Corporation recently introduced its Model 450 Sliding-Jaw Air Chuck. This air chuck (0.0001" TIR) has special ID-gripping Top Jaws and an Integral Axial Locator.

Northfield Precision Instrument has a customer who inspects and balances torque converters and other driveline parts. The customer requested a chuck that could expand to grip the ID of their female splined shafts while it rotates on their balancing machine. Previously, their customer used a "homemade" fixture that had a slip-fit without the expanding capability to grip the ID of the part. Northfield custom-designed their Model 450 sliding-jaw air chuck to also grip the ID of the part.

Northfield Precision Instrument designs and manufactures the world's most accurate air chucks for any lathe, boring machine, grinder or VMC. Models include through-hole, high-speed and quick-change. Chucks are available in SAE or metric, in sizes starting at 76 mm. Accuracies of 0.001" to 0.00001"(0.254 m) are guaranteed.

**For more information:**

Northfield Precision Instrument Corporation  
Phone: (516) 431-1928  
[www.northfield.com](http://www.northfield.com)



**PROTO** a world of solutions  
MANUFACTURING

**RESIDUAL STRESS & RETAINED AUSTENITE MEASUREMENT**

Choose from one of our portable or laboratory systems, or utilize our ISO 17025 laboratories for accurate and efficient contract measurement services.

For more information contact us at [info@protoxrd.com](mailto:info@protoxrd.com) or 1-313-965-2900

[www.protoxrd.com](http://www.protoxrd.com)

  
LXR  
STANDARD

  
LXR  
WIDEBODY

  
LXR  
MODULAR MAPPING

  
IXR  
STANDARD

  
mXR  
ULTRA PORTABLE





# Walter

## INTRODUCES CAPTO FINE BORING TOOL WITH MODULAR DESIGN

Walter has introduced the B3230 Walter Capto fine boring tool. This highly flexible, single edge precision boring tool, available in diameters ranging from 0.078 to 7.992 in. with an adjustment accuracy of 0.0001 in. on the diameter, can be used for standard as well as reverse machining and features internal coolant supply up to the cutting edge. A range of indexable inserts adapted for precision boring is available for use with this new fine boring tool, allowing for optimal cutting parameters to be employed for each material.

Heightening the B3230's flexibility is the fact that it is available with the Walter Capto™ modular toolholding interface, as well as NCT and ScrewFit. Along with its high clamping force and even force distribution, the Walter Capto interface significantly enhances the new tool's versatility. That's because many of today's machine tools include a Capto interface as standard because Capto is the most universal of interfaces, suitable for turning, drilling, counterboring and precision boring, as well as for milling, in both rotating and static modes. With this unique interface system, all machining operations can be performed on lathes, machining centers and turn-mill centers.

Walter, a global leader in the metal-working industry with over 90 years of experience in precision cutting tools for milling, drilling, turning, boring and specialized tools, helps customers improve process reliability and increase productivity. With Regional Headquarters in Waukesha, WI, Walter markets its competence brands Walter Valenite, Walter Titex, Walter Prototyp and Walter Multiply through a strong network of distributors and field engineers across subsidiaries in the USA, Canada, Mexico, Brazil and Argentina.

**For more information:**  
Walter USA, LLC  
Phone: (800) 945-5554  
[www.walter-tools.com/us](http://www.walter-tools.com/us)



**HIGHEST QUALITY**  
LEADER IN GROUND TOOTH SPIRAL BEVEL GEARS

OUR BRAND-NEW, STATE-OF-THE-ART FACILITY IS AS9100 CERTIFIED, PRODUCING THE HIGHEST QUALITY SPIRAL BEVEL, HYPOID, SPUR, AND HELICAL GEARS.

**FASTEST DELIVERY**  
SPIRAL BEVEL AND HYPOID GEARS FROM DESIGN TO DOORSTEP IN AS LITTLE AS FIVE WEEKS.

OUR CLOSED-LOOP SYSTEM, COUPLED WITH OUR GRIND-FROM-SOLID TECHNOLOGY, ENSURE CONSISTENT QUALITY AND QUICK TURNAROUND.

**RAVE** GEARS AND MACHINING  
TALENT AND TECHNOLOGY DRIVEN

+1 855 RAV GEAR      WWW.RAVEGEARS.COM

# Klingelnberg

## UNVEILS NEW PRODUCTS AT CONTROL IN STUTTGART

Klingelnberg unveiled the P 16, a new solution for efficient measurement of small components, at Control Stuttgart 2015. From May 5-8, the system supplier presented a round of talks covering its entire range of products and services.

The five big segments — “gear measurement,” “shop-floor measurement,” “dimension, form, and position mea-

surement,” “measured value analysis,” and the segment covering Klingelnberg’s wide range of services — together shared a presentation space of 220 m<sup>2</sup>.

“With the P 16, we are offering a machine based on the tried-and-true qualities of the P series, but which comes in below the P 26 in terms of footprint,” said Dr. Christof Gorgels, division man-



ager for measuring instrument construction.

Because the P 16 is based on P series technology, all software application programs are compatible.

The P 16 owes its compact size to a modification: Because of a newly developed workpiece clamping system which is optimally adapted to accommodate small workpieces, there is no need for a counter support. This allowed Klingelnberg to design a relatively small machine.

“The workpiece mounting of small components is often accomplished using a chuck,” said Georg Mies, head of measuring machine development at Klingelnberg “For this reason, we developed for the P 16 an innovative electrical clamping system that has been integrated into the workpiece axis. This clamping system is suitable both for circular and cylindrical components and for mounting short shafts.”

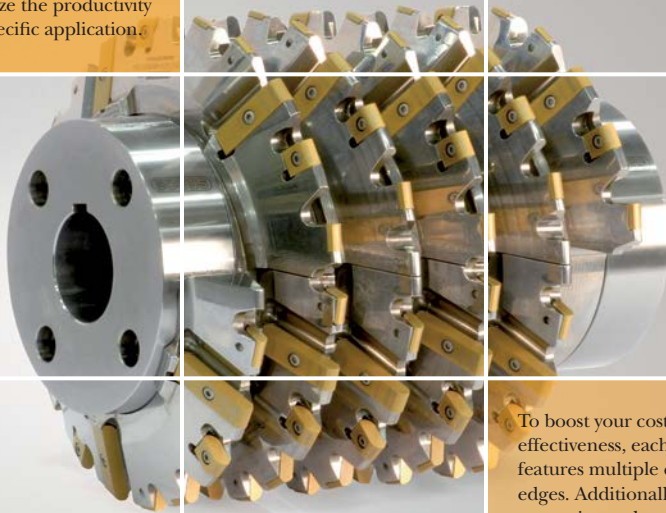
With the new precision measuring center, Klingelnberg is targeting areas in which the demands for precision in volume production are becoming increasingly stringent.

“The P 16 is specifically tailored for the requirements of small components, particularly those required in the automotive, power tools, pumps, e-mobility and small drives market segments,” said Mies.

**For more information:**

Klingelnberg GmbH  
Phone: +49 2192 81-0  
[www.klingelnberg.com](http://www.klingelnberg.com)

Capitalizing on our global experience in gear cutting, Seco has developed a comprehensive line of indexable gear hobs and gashers. This range of cutters incorporates insert grades and coatings that allow you to maximize the productivity of your specific application.



To boost your cost effectiveness, each insert features multiple cutting edges. Additionally, we customize each cutter to your unique needs, ensuring the best possible solution.

## GEAR CUTTERS BACKED BY A WORLD OF EXPERTISE

SECO TOOLS.COM/GEAR1



SCAN THIS QR CODE TO LEARN MORE ABOUT OUR GEAR CUTTERS!





# Heimatec

## INTRODUCES COOLANT-THRU FEATURE

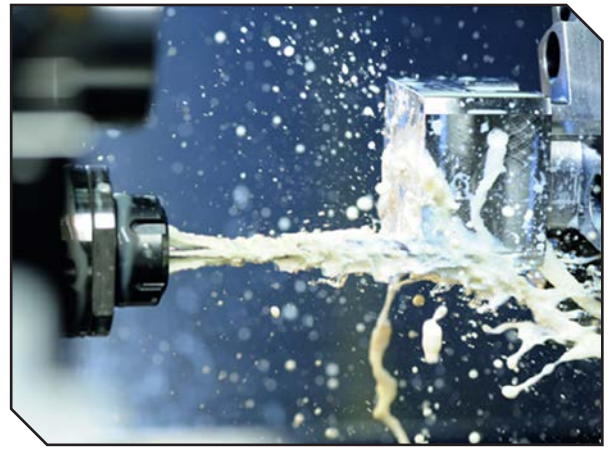
Heimatec recently announced the immediate availability of its newest development, a coolant-thru feature on all the company's current line items.

Coolant-thru technology is often the answer for faster, cleaner cutting on larger and deeper parts, where the chips and excess heat build-up are significant challenges. Heimatec now offers high-pressure coolant-thru designs up to 1000 psi on straight and 2000 psi on angle head tools.

"Production drilling should almost always be done with internal coolant tools and this development means we'll be able to satisfy more customer needs in that area," says Heimatec President Preben Hansen.

### For more information:

Heimatec, Inc.  
Phone: (847) 749-0633  
[www.heimatecinc.com](http://www.heimatecinc.com)



# AKGears

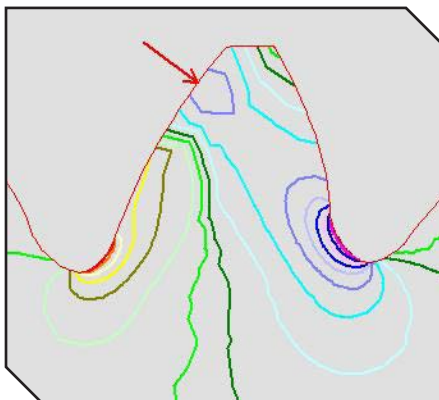
## UNVEILS LATEST TOOTH ROOT FILLET OPTIMIZATION SOFTWARE

AKGears recently introduced the only commercially available tooth root fillet optimization software that defines the tooth root fillet profile to provide minimum bending stress concentration.

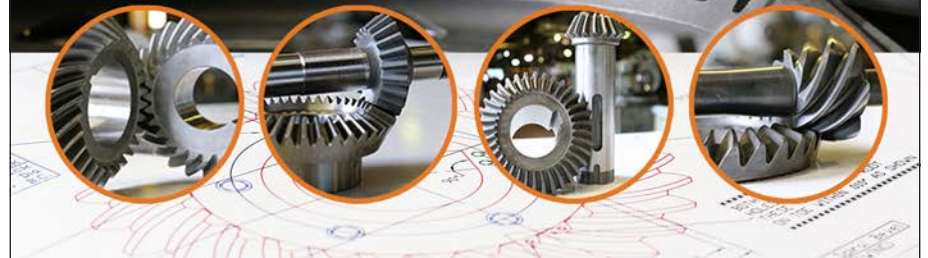
The software allows increasing gear load capacity by 15-25% and is applicable to involute and non-involute gears with external and internal, symmetric and asymmetric teeth. This optimization technique is presently employed in various gear drives for aerospace (Boeing), automotive (Delphi), medical devices (Abbott Labs), consumer products (Panasonic), and many other industries.

### For more information:

AKGears, LLC  
Phone: (651) 308-8899  
[www.akgears.com](http://www.akgears.com)



Gearing your past to power your future.



### Breakdown Services

We understand the urgency of meeting critical deadlines. We offer our customers expedited services without sacrificing quality.

### Heat Treatment

Our in-house heat treat facility performs a full range of services that include annealing, carburizing, and thru hardening.



B&R Machine and Gear Corporation is a full service gear manufacturing facility driven to power your equipment with reliable and durable gears that are built to perform and last. Find the perfect mesh. No matter the gear, we've got you covered.

VISIT OUR WEBSITE [BRGEAR.COM](http://BRGEAR.COM) FOR MORE INFORMATION

# Oelheld

## INTRODUCES AIRFORGE 4027 CLEAN LUBRICATION

Oelheld U.S. recently introduced AirForge 4027, a newly developed protective lubricant for hot forging of steel and alloys.

It's designed to deliver results when metal protection against oxidation, gas diffusion and heat is required. AirForge 4027 is colorless and does not contain graphite. AirForge 4027 is diluted in

water and can be used either by dipping or spraying the metal blanks.

The product is designed for a wide range of operations, even on challenging work piece shapes. It is free of lead or any other toxic components and does not contain solvents.



**For more information:**

Oelheld U.S., Inc.  
Phone: (847) 531-8501  
[www.oelheld.com](http://www.oelheld.com)



### PEOPLE AND TECHNOLOGY MAKE THE DIFFERENCE

At Presrite, our experience, innovation and expertise ensure that you get the best net and near-net forgings. Our new Tech Center has state-of-the-art design, engineering technology and die-making capabilities.

- Dedicated state-of-the-art facility
- Presses up to 6,000 tons of capacity
- .008-.060 stock allowance on gear blanks
- ISO 9001:2008
- TS 16949:2009



[www.presrite.com](http://www.presrite.com) • 216-441-5990



## Ti-Coating

ANNOUNCES ITS TINALOX SN2 COATING FOR APPLICATIONS IN ALL ISO MATERIALS

Ti-Coating recently announced its new PVD coating Tinalox SN2 for indexable carbide tooling. The TiAlN-based coating provides excellent machining characteristics and extends tool life for a variety of applications including turning, threading and milling. The properties of Tinalox SN2 allow it to machine a range of materials from steel to stainless steel and cast iron. The supernitride coating also provides high oxidation resistance.

“With Tinalox SN2, we have a single coating to offer customers who routinely machine a variety of materials,” said Keith Metzinger, sales manager for



# Gleason

## INTRODUCES NEW BEVEL GEAR LAPPING TECHNOLOGY

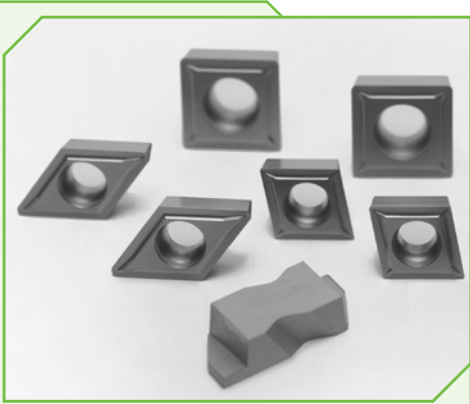
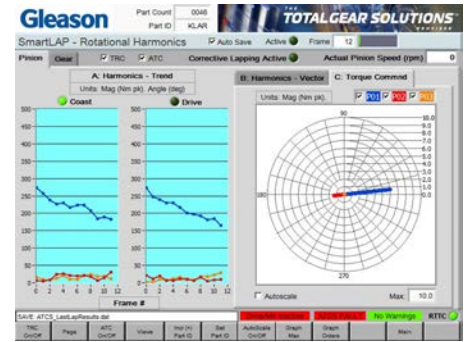
Gleason Corporation recently announced SmartLAP, a technology for lapping bevel gear sets, with increased productivity, control and data collection.

Available on the Gleason 600HTL Turbo Lapper Hypoid Lapping Machine (both new and as a field retrofit), the SmartLAP system combines a unique, yet simple gear spindle design with real-time motion-error measurement. It brings dynamic lapping forces under active servo control. The instantaneous tooth-to-tooth forces are no longer just a function of incoming part quality and passive physics but are instead actively modified by this smart mechatronic system to consistently improve DIN/AGMA part quality.

These enhanced dynamics also enable higher productivity without compromising quality. Pinion speeds and gear torques can now be increased by 30% or more without introducing the spacing errors that previously prevented faster cycles. The system also compensates for workholding run-out errors, making production less sensitive to tooling conditions. In addition, the tester-like data that is collected is displayed during the lapping process, giving users real-time insight into the process.

**For more information:**

Gleason Corporation  
Phone: (585) 473-1000  
[www.gleason.com](http://www.gleason.com)



Ti-Coating. “Furthermore, the coating performs predictably at a range of cutting speeds and applications, from finish to medium. The coating is the latest addition to the company’s range of PVD and CVD coatings.”

**For more information:**

Ti-Coating, Inc  
Phone: (800) 262-5166  
[www.ticoating.com](http://www.ticoating.com)

**1.800.569.1420**

# EXPECT MORE

Our team is committed to keeping our promises and ensuring your complete satisfaction from inquiry to delivery.

“I’ll get your quote within 4 hours.”

Brandy - Inside Sales Associate

**Fast Quoting**

**Exceptional Product Quality**

**On-Time Delivery**

# McINNES ROLLED RINGS

[McInnesRolledRings.com/ExpectMore](http://McInnesRolledRings.com/ExpectMore)

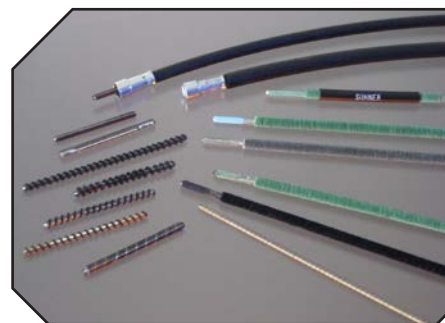
# Suhner

OFFERING SU-FLOCK SILENT FLEX SHAFT FOR NOISE REDUCTION;  
XXL SHAFT FOR DIFFICULT TASKS

Flexible shafts do not create noise, but they can transmit vibrations from the power source, thus creating unacceptable sound levels. Suhner Mfg., Inc. supplies ready-to-use assemblies according to various specs that are proven technologies; simple, ready-to-

use solutions; virtually maintenance-free; rugged and durably designed; and environmentally friendly.

SU-Flock shafts have been especially designed for applications in which noise is a critical factor such as luxury car power seats. There are numerous



**CUBITRON™ II**

Powered  
by precision

## 3M™ Abrasives for Powertrain Components

3M offers one of the world's most extensive portfolios of precision abrasives for grinding and finishing powertrain components – all engineered to take you to the next level of precision and productivity.

Gear up with high-performance 3M abrasives for applications including:

- Gear grinding
- Camshaft and crankshaft grinding
- Cylindrical grinding
- Centerless grinding
- Microfinishing
- Dressing and truing



### NEW! Driven by Innovation



A 16-page brochure devoted exclusively to grinding and finishing powertrain components. To receive your free copy – and to find additional information on 3M abrasives for powertrain components, visit:

[www.3M.com/PrecisionGTAug](http://www.3M.com/PrecisionGTAug)



© 3M 2014. 3M is a trademark of 3M Company. Used under license by 3M subsidiaries and affiliates.

applications in other fields where friction and noise are of critical importance. These shafts are available either spiral flocked or fully flocked.

Suhner also offers a heavy-duty flex-shaft able to exceed 3,500 inch-pound in braking torque while offering a bend radius of less than 20 inches. This 1” core diameter shaft is characterized by its strength and flexibility, allowing it to achieve most difficult tasks.

### For more information:

Suhner Mfg., Inc.  
Phone: (706) 235-8046  
[info.usa@suhner.com](mailto:info.usa@suhner.com)  
[www.suhner.com](http://www.suhner.com)



# Haven't heard about Scudding®? Call Scott and he'll tell you all about it.



## The number is 734-973-7800 and he's waiting to hear from you!

GMTA brings the proven and patented Profilator technology of Scudding® to the North American market, for special gear and spline applications.

With Scudding, quality meets speed in a new dimension of productivity, FIVE TIMES faster than gear shaping. The surface of the workpiece is formed through several small enveloping cuts providing a surface finish and quality level far superior to hobbing, shaping, or broaching.

Scudding is a continuous cutting process that produces external and internal gears/splines as well as spur and helical gearing, with no idle strokes as you have in the shaping process.

Ring gears, sliding sleeves and annulus gearing, whether internal helical shapes or internal spur, blind spline, plus synchronizer parts with block tooth features, and synchronizer hubs are among the many applications for this revolutionary technology from GMTA.

You want to know more, don't you? Call Scott, he's waiting to tell you all about Scudding.



**Profilator**  
Gear Machines, Featuring Our  
Patented Scudding® Technology  
<http://bit.ly/gmtascudding>  
For a preview, scan this QR code



# Times Aren't A-Changin for Broaching, and That's Just Fine

Industry experts give us the cold, hard facts on the current state of broaching

Erik Schmidt, Assistant Editor

**In 1964, a young and tidy Bob Dylan sang away in that infamous voice of his, all nasally and grating yet wonderfully distinct, opining to the fervent masses: "The times, they are a-changin."**

The inherent beauty of the song is that Dylan was musing about everything and nothing all at once, as the timeless lyrics are vague enough to work on a never-ending amount of levels — political, societal, technological, religious, et al.

What Dylan was probably not singing about, however, is broaching.

Broaching machines could accurately be described as dinosaurs — ancient, massive constructs that they are; unwieldy and intimidating, perhaps, but incredibly effective. For years the broaching industry has remained more or less stagnant, though nonetheless strong and undiminished. Maybe it's not exactly trudging forward, but it is strafing sideways with giant, thunderous steps.

As such, there really isn't any new, earth-shattering information to divulge; no clever, fluffy words to weave on the precious pages that follow.

So instead of wasting your time with filler verbiage, we decided we're just going to give it to you straight.

Better yet, we're going to let *them* give it to you:

## Matt Egrin — President of Broaching Machine Specialties (Novi, MI)

"It's the same as ever, in that broaching is still the best way to make a spline — or at least quickly. Other internal shapes, such as hexes and squares are best made by broaching as well and probably always will be. Some of the external or surface broaching operations are being done with CNC now, but there are still cases where the production quantities are such that you still need to broach it because it's the fastest and least expensive way to make them.

"You could make the argument that people coming out of the engineering schools today aren't learning about [broaching], because the technology is so old. It's what people did 50 years ago, so maybe it's true that people don't have the same knowl-

edge of the process as they would have in the past because they're learning about CNC machining and other types of machining, but not the old standby, tried and true technology.

"The thing that people need to be educated about is that [broaching] still is the most efficient and cost-effective way to remove metal. It's possible that some people still







don't know that, or are afraid of it because they don't have experience with it, but it's actually a very simple technology. It's simpler to run and maintain than even a CNC machine.

"Once people get over their initial fears thinking that it's complicated and foreign, they'll realize how easy broaching is and how cost effective it is. My father has been in this business since the 1960s and what he told me 20 years ago is still true today: Once someone buys a broaching machine and discovers for themselves how productive they are and inexpensive to operate they are, they almost always find another application to buy a broach for."

**Tim Espy – General Manager, VW Broaching (Chicago, IL)**

"There's not much new going on in broaching other than customers asking that we hold tighter and tighter tolerances. They're thinking that these are high-end CNC machines but, of course, they're not. So if there's anything new, it's that. Our challenge is always to be more competitive with our tooling and designing our tooling in different ways to accommodate those tighter tolerances.

"[Broaching] is going to become more cost effective as the younger engineers coming out of college are introduced to this method of manufacturing and this method of machining, and they see what it can do. Right now they're really not taught anything about it. It's con-

sidered a blind art. Their instructors kind of steer them away from that and look for alternative method of machining.

"I think [broaching] is going to expand. I think that as people become more conscious of cost and realize that we can hold tolerances and move material faster than any other method of machining – nobody can move metal faster than we can; we can move cubic inches of material in a matter of seconds – I think they're going to be more prone to accept it as a viable method of manufacture for their products.

"As they learn that I think we're going to grow right along with them."

**OPEN DIE FORGINGS & SEAMLESS ROLLED RINGS**



**ALL PARTS ROUGH MACHINED**

**100% UT TESTED**

**108" Max O.D.**

**6" Min O.D.**

**Up to 55,000 lbs**

**FAST QUOTES**

**48 HOURS OR LESS**

**ISO9001:2008 AS9100/2009C**

**All Metals & Forge Group**

**STEELFORGE.COM**

**800.600.9290**

**973.276.5000**

As a value added service to its customers, AM&FG sponsors **Manufacturing Talk Radio**, The Voice of Manufacturing Globally



**MFGTALKRADIO.COM**

**Live Broadcast On the Web Every Tues. at 1PM EST**



**Bob Ezor, Vice President/General Manager – Pioneer Broach Company (Los Angeles, CA)**

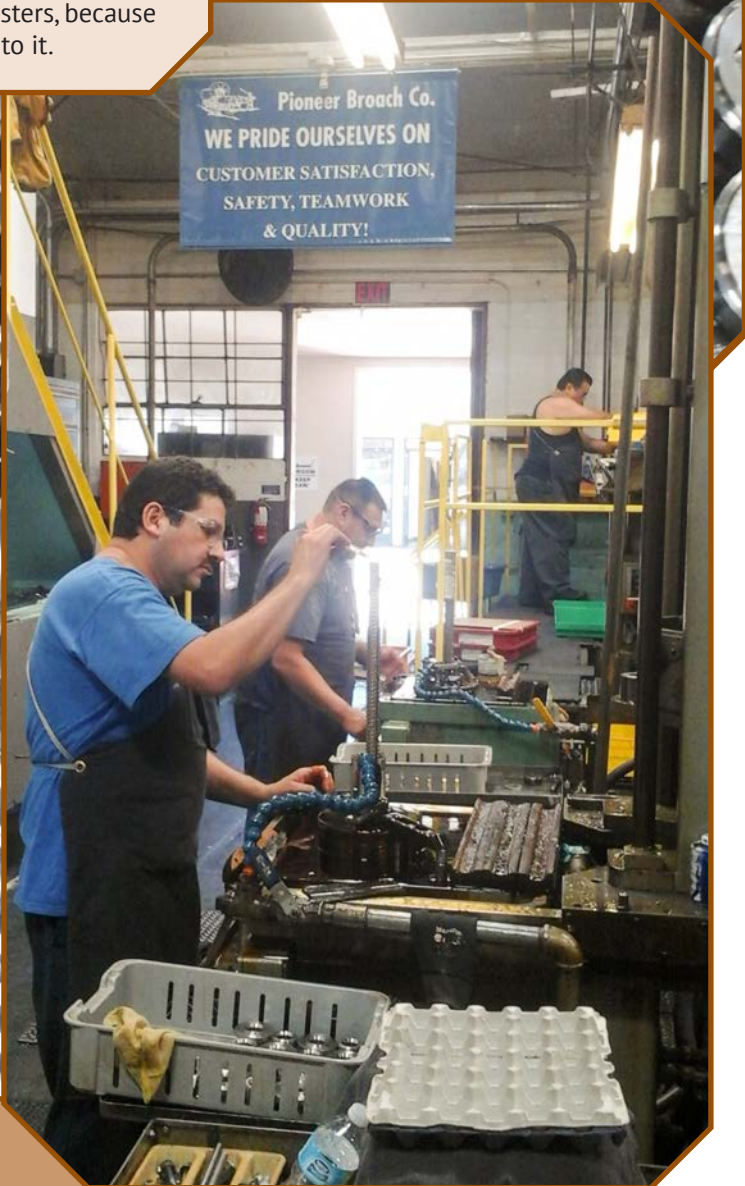
“There’s an art form to what we’re doing. Ultimately, it’s ‘black magic.’ Yeah, it’s a machinist; it’s a grinding process; it’s a production process; but there is an art form to it.

“We have master setup people who are getting towards the end of their career, so what do you do? You get out your camera and you get out your video and you get a young engineer with him and you document everything they’re doing and how they’re doing it. It’s an art form, and our toolmakers are artists at what they’re doing.

“I’ve got jobs where 12 or 13 guys try their hand at it and they can’t do it. The guy who can do it shows them, put your hand

here, apply the right amount of pressure, let it off right at that spot,’ and so on and so forth. Good guys – smart broach guys – nuh-uh, can’t do it. Then I see it and I’m like, ‘How hard could it be? Let me try that’ – no good. The master gets back on there and he gets it, because he’s got feel, he’s an artist – not just anybody can do it.

“You can write it down, you can take pictures, you can even show a guy, but there is an absolute skill level to what we do. It’s just something that if you don’t do it every day – or even if you *do* do it every day – you’re not going to be able to do it like the masters, because there’s a skill level to it.





**Leon Agan, Project  
Manager/Machine  
Estimator – American Broach  
and Machine (Ypsilanti, MI)**

"I think that the demise as a process in high-volume production was overestimated early on. I think it's going to be around for quite a while, because there's still no faster way to cut high volumes of parts. We're probably going to go towards dry broaching processes more and more because coolant disposal and contamination becomes an issue. The only competition for helical ring broaching is skiving operations.

"I think the trend is for hard broaching after a spline is cut into a part and goes through heat treat, they want to go back and run a carbide or some other type of broach to recut the form to size. It's been around for quite a while but people are starting to take note (in the last two or three years) that it's necessary, especially with the tighter tolerances required by automakers and aerospace. Basically, it's overcoming heat treat distortion, because you want to broach up to no higher than 30 R<sub>w</sub> C. If you heat treat the parts and get some sort of distortion, you can go back and recut the spline to the proper size.

"I think the level of interest will probably remain at about the level it is now. I think the driving force is just going to be the sales of automobiles and heavy equipment. As markets expand, more companies are going to need to produce internal splines and things like that.

"The other trend is the move towards electromechanically driven machines, whether that's ball screws, roller screws or rack and pinion, rather than the hydraulically powered machines that are tradition. However, we have found that the hydraulic machines are workhorses and last a long time."



**teco**  
Werkzeugmaschinen  
GmbH & Co. KG

## WELL MAINTAINED Machine Tools from Germany

Our machines run through tests, are supplied with certificates and to be seen under power

### BORERS, HBM

- **CNC SKODA**, 1990/2007, spindle 250 mm, X/Y/Z/W=7000/6100/2000/1600 mm, Z+W=3600 mm, latest CNC
- **CNC TITAN**, 1984/2010, spindle 200 mm, X/Y/Z/W=9000/4000/1200/800 mm, Z+W=2000 mm, latest CNC
- **UNION**, 1984/2011, spindle 110 mm, table type, table 1600 x 1400 mm, latest DRO

### VTLS, DOUBLE COLUMN

- **TITAN**, 1983/2013, faceplate 2000 mm Ø, swing 2200 mm,
- **CNC TITAN**, 1983/2011, faceplate 2500 mm Ø, swing 2700 mm,
- **TITAN** 1987/2012, faceplate 4000 mm Ø, swing 5000 mm,

### GEAR GRINDING

- **CNC REISHAUER RZ 400**, 2002, in state-of-the art, gear-Ø/module 400/8 mm
- **CNC REISHAUER RZ 150**, 2004, gear-Ø/module 150/3 mm
- **CNC REISHAUER RZ 362**, 2000, tested + certified, gear-Ø/module 360/7 mm
- **CNC HÖFLER H 1250+1253**, 1996+1991, tested and certified, gear-Ø/module 1250/25 mm
- **CNC HÖFLER H 2500/3100**, 1994 retrofitted and upgraded with 10 axes CNC, tested and certified. gear-Ø/module 3100/32 mm

### Think SMART and ECONOMICAL

see details + pictures under

[www.teco-germany.com](http://www.teco-germany.com)

**TECO Werkzeugmaschinen GmbH & Co. KG**

Westring 1, 40721 Hilden, Germany

Tel.: +49 2103/3682-0 / Fax: +49 2103/3682-20

E-mail: [info@teco-germany.com](mailto:info@teco-germany.com)

And also gear hobbers, shapers  
+ other machine tools

## GOTTA GET BACK IN TIME...

It may not be as impressive as a DeLorean, but if time travel is your thing, we have you covered at

WWW.

**geartechnology**

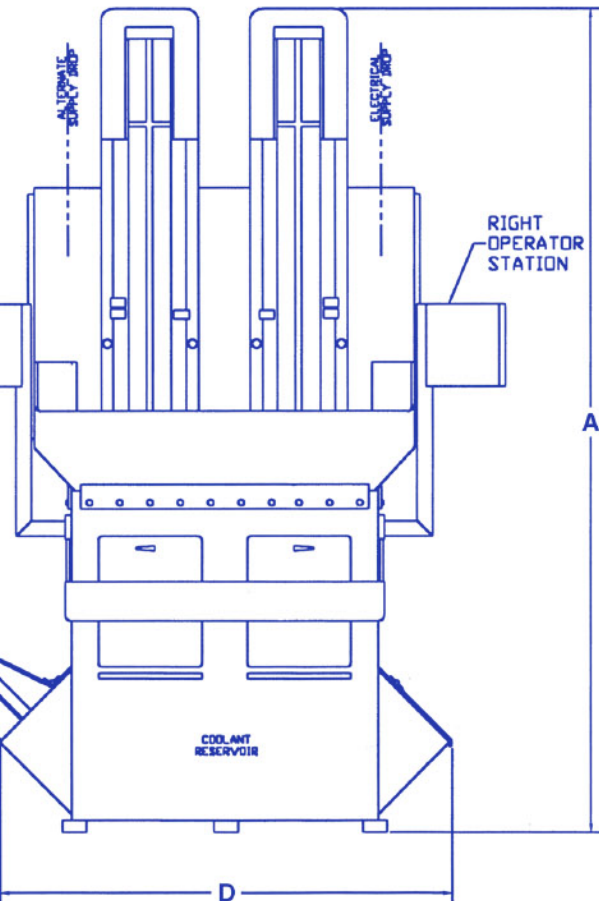
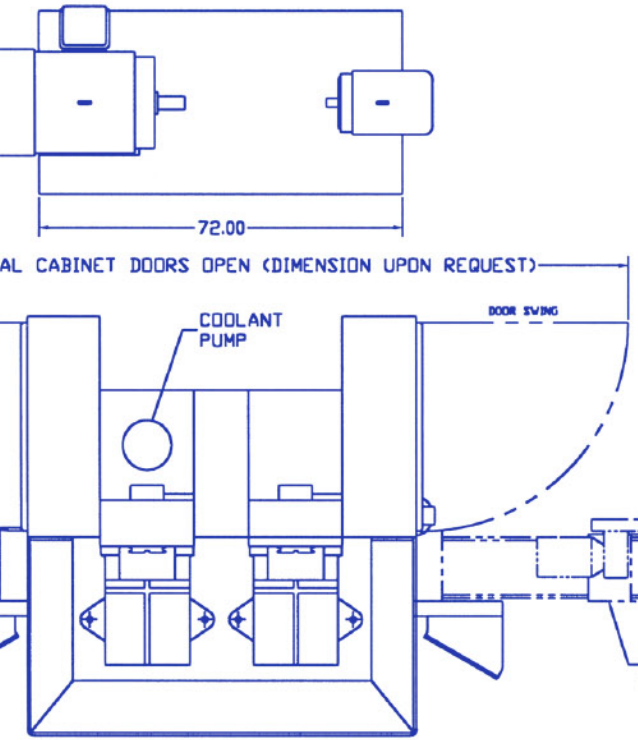
.com

Today, our user-friendly archive (1984 to present) is now available online with an optimized search engine that allows subscribers to locate specific articles using keywords and phrases.

We've created a database where subscribers can peruse more than thirty years of gear manufacturing articles without leaving their desks.

In an era where content is king, let *Gear Technology* be your destination for the past, present and future of gear manufacturing.

[www.geartechnology.com/issues](http://www.geartechnology.com/issues).



**Jeffrey Frantz, Sales Manager – Ohio Broach & Machine (Willoughby, OH)**

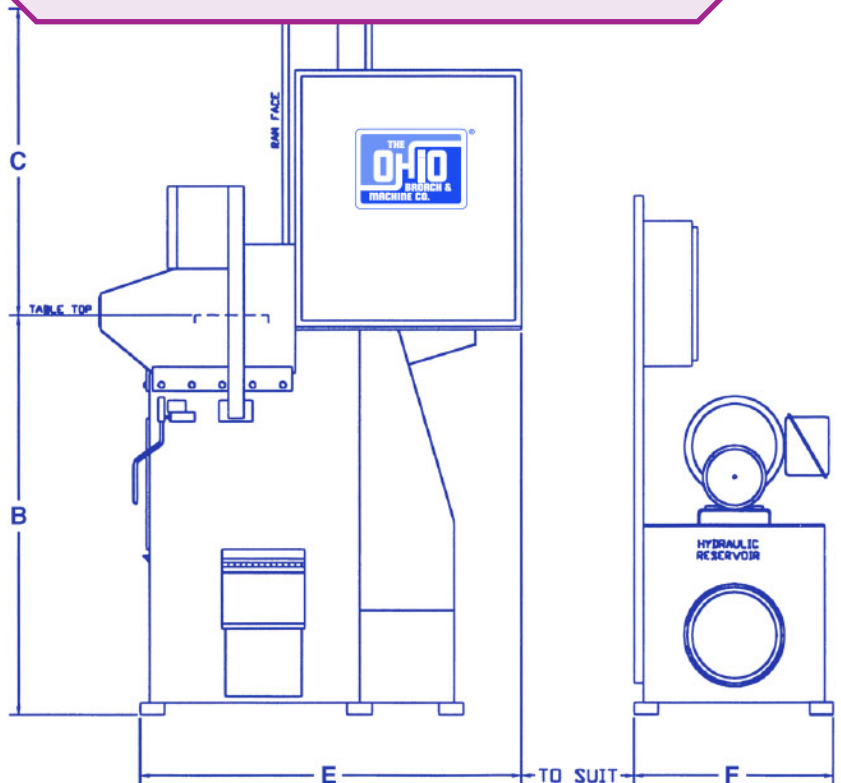
“Broaching really lends itself to high-production. It really lends itself from part to part. It can hold very close tolerances. But in that same token, the tooling is very specific, the setups are long and if your mode of manufacturing is such that you run large numbers of parts, you can’t beat the broaching process. But in today’s world we’re faced with lean manufacturing and they’re not setting up to run large numbers of parts. They want to run 400, 500 parts and then change over to the next part. That is one reason why people are hesitant to go into broaching – because the setups don’t allow you to do that, basically.

“Broaching is basically in two different parts: You’ve got surface broaching, where you broach on the outside of a part, and you’ve got internal broaching, which is probably the most traditional, where you’re putting keyways and splines inside of a hole.

“Surface broaching is in a world of hurt, because of the lean manufacturing. That end of broaching is kind of dying. The internal broaching, there’s still no better way to put those forms into parts. That state of broaching is still going very well, and it’s where our future lies.

“In years past – 20 years or more – organizations like SME were very popular in their meetings. Oftentimes, a broach company would come in and educate a company on broaching. People just aren’t attending those meetings anymore. All external companies are hurting. The young engineers are basically all tuned into the internet.

“So how do I get onto the internet and get the broaching word out to these engineers who have never heard of it or haven’t learned it in school? It’s a challenge, and I don’t know if I have the answer right now.”





For Related Articles Search

broaching

at [www.geartechnology.com](http://www.geartechnology.com)

### Ron Hehn, General Manager – Universal Broaching (Elk Grove, IL)


“The process has remained relatively the same since its inception. There have been new developments from a tool manufacturing standpoint, things like tighter tolerances and holding the broach tools and things like that.

“The thing is, they don’t really teach [broaching in schools] anymore. It’s kind of a black art, to be honest. I think [broaching] is a viable process and will continue to be a viable process, but some people aren’t in-tune to it and are looking at EDM and things like that. Don’t get me wrong, it’s a great process, it’s just when you get into higher productions it’s not a cost-effective method to produce certain figures on parts.

“I think there needs to be a little more emphasis on [broaching] as a process for students going through some type of manufacturing program. It’s such a specialized process and that’s why not everybody does it. That’s kind of why there’s just broaching companies, just like there’s people who do just grinding, because that’s what they specialize in. It’s just that grinding tends to be a little more commonplace than broaching is.

“When looking at the state of broaching, it’s really going to be a reflection on a lot of the major industries, such as automotive or heavy equipment and things like that, where there are a lot of broach components that are used. A lot of external surface broaching has gone down quite a bit over the last 10, 15, 20 years, just with the advent of CNC machines that have live tooling and things like that, where flats or slots or things of that nature can be done right on the same machine instead of a secondary machine like broaching.

“As far as internal shapes like keyways or splines or things like that, there still isn’t a better cost effective method to produce those types of features than broaching – especially when you’re talking about production quantities or higher volumes.

“You’re not going to find a more effective way to do it.” 

#### For more information:

Broaching Machine Specialties  
Phone: (248) 471-4500  
[www.broachingmachine.com](http://www.broachingmachine.com)

Pioneer Broach Company  
Phone: (323) 728-1263  
[www.pioneerbroach.com](http://www.pioneerbroach.com)

VW Broaching Service, Inc.  
Phone: (773) 533-9000  
[www.vwbroaching.com](http://www.vwbroaching.com)

American Broach and Machine  
Phone: (734) 961-0300  
[www.americanbroach.com](http://www.americanbroach.com)

Ohio Broach & Machine Co.  
Phone: (440) 946-1040  
[www.ohiobroach.com](http://www.ohiobroach.com)

Universal Broaching, Inc.  
Phone: (847) 228-1440  
[www.universalbroaching.com](http://www.universalbroaching.com)

# NVH Analysis Within the Design Process

Brian Wilson

“If you want to find the secrets of the universe, think in terms of energy, frequency and vibration.

– Nikola Tesla”

## Introduction

At times, in the midst of troubleshooting an automotive transmission or axle gear whine problem during the launch phase of a new vehicle program, a powertrain NVH (noise, vibration and harshness) engineer might be inclined to agree with Mr. Tesla, that the solution to the issue at hand just might in fact be a secret of the universe. Many such exercises begin with “ear to gear” engineering implemented by an unknowing individual while driving a reportedly noisy vehicle. The timeless engineering process that goes something like: “I hear gear whine; something must be wrong with the gears. Perhaps bent teeth? Fix the gears.” The gear and/or NVH engineering team’s reaction is often a silver bullet approach: trying every countermeasure that has worked in the past, as fast as possible, one at a time. This behavior is not only commonplace, but for the most part, still an accepted practice throughout not only the automotive landscape, but all industries when dealing with passenger compartment gear whine issues.

For a while, at least in the automotive industry, it seemed as if management of passenger compartment gear whine had reached a certain level of containment; road, wind and internal combustion engine noise provided just enough masking, vehicle structural and acoustic sensitivities were being properly managed, and high quality gears were being manufactured, such that tonal noise from the transmission and axle were barely perceptible in most new vehicles, let alone annoying. Major OEMs were grinding gears specifically for controlling quality, and generally, most

gear design engineers understood that high levels of gear transmission error equate to passenger compartment gear whine. Automotive companies were willing to invest in higher levels of sound packaging for vehicles, as well as engineering chassis that were less sensitive to gear mesh forces.

Perhaps it was the dual effects of the Great Recession and the Green Movement, but, in recent years passen-

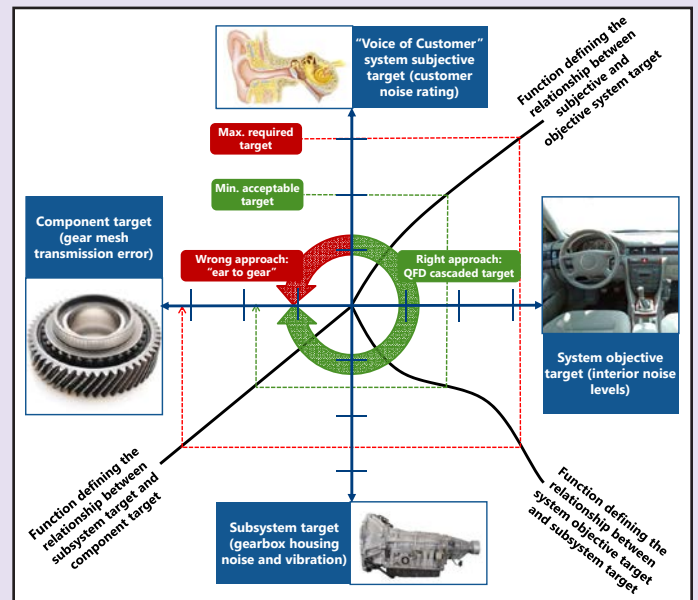
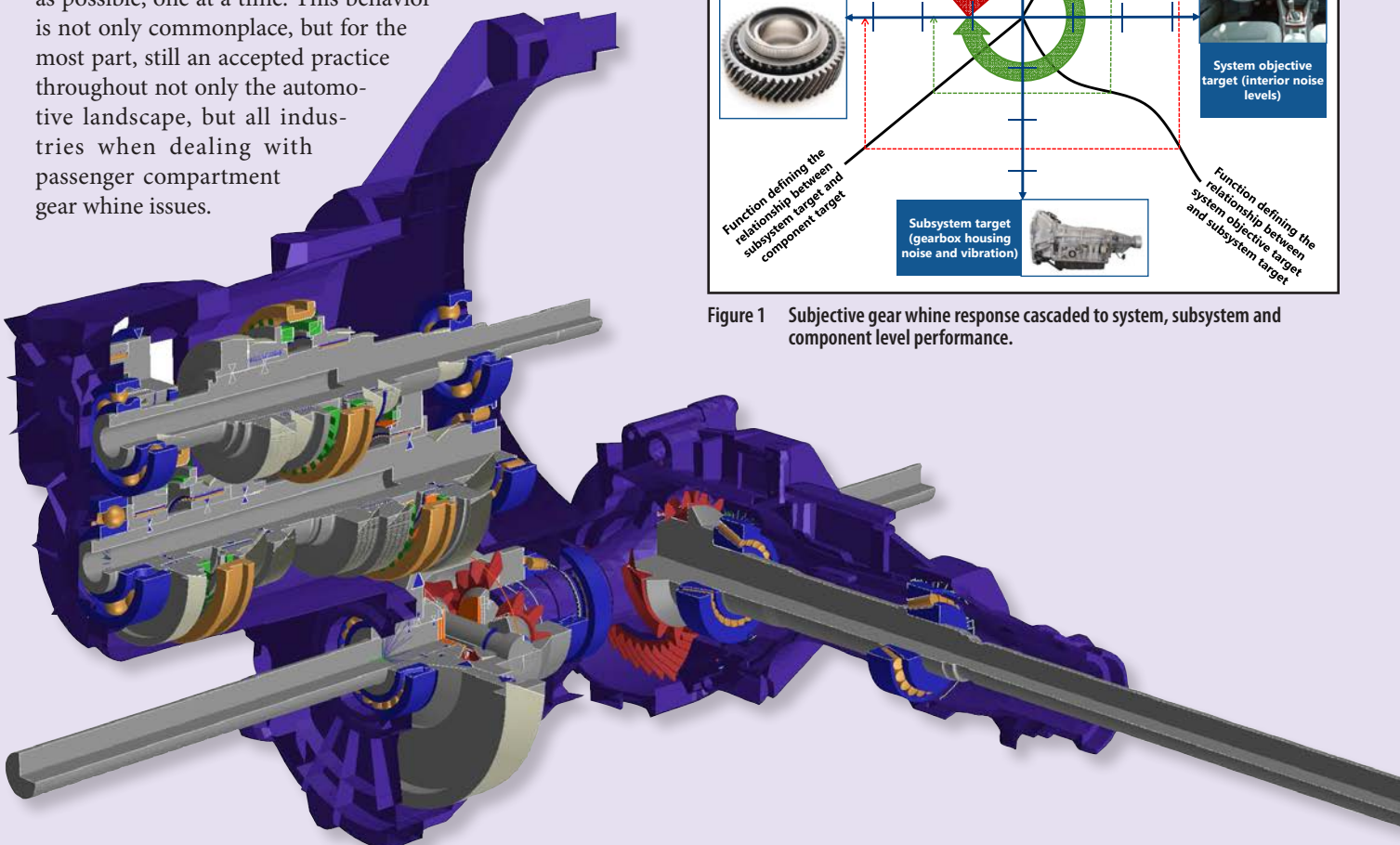


Figure 1 Subjective gear whine response cascaded to system, subsystem and component level performance.





ger compartment refinement of tonal noises has suffered from:

1. less investment in sound packaging,
2. less experienced powertrain and chassis NVH engineers following massive retirements of the skilled work force,
3. alternatives to internal combustion engines, including the increasing popularity of hybrid and electric vehicles, thereby reducing the effects of engine masking, and
4. a slight shift away from expensive gear grinding operations, compromising gear quality.

An additional important trend contributing towards increased passenger compartment gear whine includes the major automotive transmission OEMs producing 8+ speeds in automatic transmissions in order to help improve fuel economy, but struggling to properly manage the planetary mesh forces for optimal NVH. The practice is to select the planetary tooth numbers and spacing (phasing) such that the energy in the mesh is significantly reduced. However, the complexity of such planetary designs often produces unexpected energy in sidebands surrounding the main mesh frequency, and as well as the associated mesh harmonics.

## Ideal Design Process for Managing Gear Whine

The customer is always right. This is a basic principle regarding customer products or services. As such, the “Voice of the Customer” should be factored into the design of all consumer products, including the noise performance of transmission and axles, along with other performance attributes such as durability, efficiency, cost, weight, etc. A quality function deployment (QFD) approach is useful for visualizing how gear micro-

geometry, for instance, could be directly linked to subjective passenger compartment gear whine (Figure 1).

With a little imagination, an allowable variation in passenger compartment subjective ratings could translate into not only gear macro/micro-geometry design targets, but also allowable manufacturing variation for the gears. Practically speaking, the Voice of the Customer should be used to help the manufacturing team decide between rolling, shaving or grinding gears. In

**WHEN YOU NEED IT RIGHT  
THE FIRST TIME**

# The Broach MASTERS

**& Universal Gear**

The quality and precision of our Broaches, Shaper Cutters and Gears have won customers world-wide - from the smallest gear shop to NASA and the Mars Rover.

- Broach & Shaper Cutter manufacturing & repair
- Gear & Spline—prototype to production
- Master Gears & Gages
- Small & fine pitch

**Precision. Performance. Perfection.  
The First time and every time.**

**The Broach Masters, Inc.**  
1605 Industrial Drive  
Auburn, CA 95603  
Phone: (530) 885-1939  
Fax: (530) 885-8157  
Web: [www.broachmasters.com](http://www.broachmasters.com)  
Email: [info@broachmasters.com](mailto:info@broachmasters.com)

MADE IN U.S.A.

QUALITY TOOLS  
SERVICE  
DEDICATED TO EXCELLENCE

Made in USA

**Much More Than Just a Broach Company!**

## The Perfect Geared Assembly

for your Medical, Laboratory, Instrument, Robotics, Semi-Conductor, Automation or other Precision application

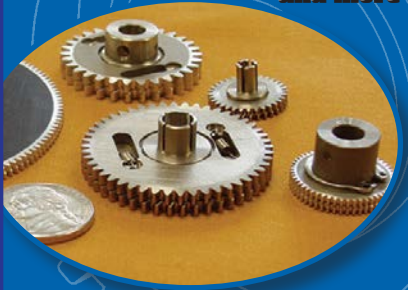
## Custom Solutions

Fully integrated, turnkey solutions including manufacturing, engineering, assembly, testing and custom machining



## Stock Solutions

Choose from over 31,000 standard components, including bearings, belts, couplings, fasteners, gears, gearboxes, linear motion, racks, sprockets, worms and more



WWW.NORDEX.COM

**Nordex**  
INCORPORATED

turnkey solutions with a higher level of intelligence

426 Federal Road  
Brookfield, CT 06804  
Phone (800) 243-0986 or  
(203) 775-4877  
Fax: (203) 775-6552  
sales@nordex.com

Quality Solutions Since 1960

order to establish a firm link between subjective ratings and objective performance measurable by microphones, major automotive OEMs establish tonal noise targets for the passenger compartment based on studies performed and documented by Zwicker and Fastl (Ref. 1). These psychoacoustic theories outline how human hearing processes tonal noise in the presence of both broadband noise (tone-on-random masking) and other tones (tone-on-tone masking) (Ref. 2).

If using a source-path-receiver (SPR) model for gear whine, or any product noise for that matter, the customer derived tonal noise targets fit nicely into the “receiver” category, as shown in Figure 2. Clearly, managing the “path” is equally as important as managing the “source.” Simplistically, for an automotive transmission, the “path” is represented by the transfer of forces from the gear mesh, through the shafts and bearings, ultimately causing the transmission housing to vibrate. Likewise, another “path” follows the forces from the vibrating transmission system through the

various structure-borne and airborne paths of the vehicle, eventually arriving in the passenger compartment. This path from the transmission system to the passenger compartment is often quantified by performing a noise path analysis (NPA), or also commonly referred to as transfer path analysis (TPA); automotive OEMs establish targets for the path parameters, as part of managing the entire chain of passenger compartment gear whine (Ref. 3).

It should be noted that the QFD, SPR, and NPA/TPA quantifications of gear whine can be applied to any product in any industry. For example, wind turbine gearboxes and the resulting neighborhood noise (Ref. 4); agricultural transmissions and axles resulting in extraneous pass-by noise; helicopter gearboxes resulting in operator cabin noise, possibly affecting pilot fatigue. The product list demonstrating signs of gear whine is endless: household appliances, power tools, recreational vehicles, buses, mining trucks, construction equipment, material handling vehicles, etc. In fact, if you know a powertrain NVH engi-

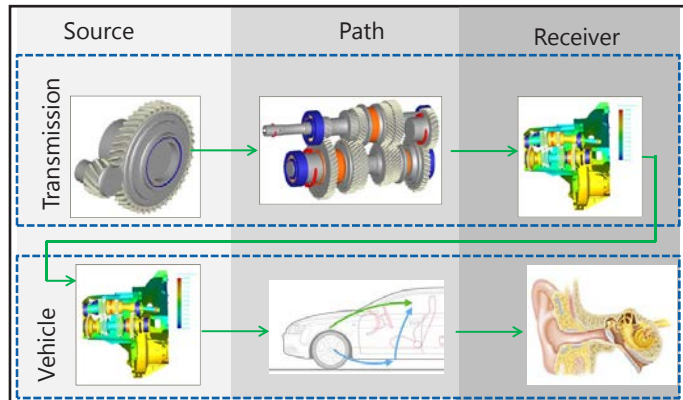


Figure 2 Source-Path-Receiver Models for Transmission and Vehicle Systems

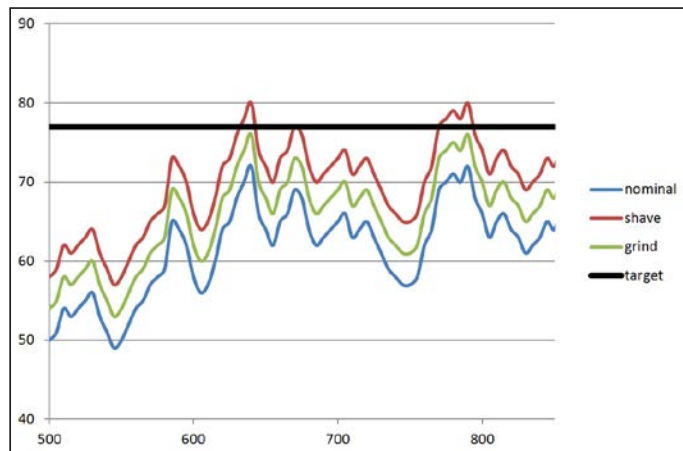


Figure 3 Radiated Gear Noise vs. Tonal Target



neer, you have most likely witnessed the endless subjective ratings of all things in their immediate environment, to the frustration of many spouses. So much to improve upon!

Two schools of practice exist regarding the gearbox design process. Despite the ever-growing reliance on using cutting edge CAE tools up-front in the design process, the experienced-based approach—driven by design rules, a decent spreadsheet for sizing gears, a reliable CAD package, and fundamental know-how about gear and bearings—maintains a strong following, especially in low-volume heavy industrial sectors. The reasons for this are clear: if it works, use it. And, outside of the automotive industry, gear whine issues perhaps are not at the top of every gear train development engineer's list; should an issue arise, it is dealt with appropriately. In recent years, however, I have noticed that on average the experienced gear designers are approaching the twilight of their careers, and despite the best efforts by institutions such as Ohio State University to fill the coffers, experienced-based design work is subsiding naturally due to this attrition. Coupled with the need for all manufactured gearboxes to be competitive globally in terms of cost, weight and performance, regardless of volume, the need to integrate more modern CAE tools is also rising rapidly.

Therefore, using advanced CAE tools focusing on gear and bearing analysis, an engineer with drivetrain design responsibilities is able to predict certain performance behaviors well ahead of any design-freeze dates, and preferably well before the tooling is ordered. In fact, the CAE tools are now advanced to the point where it's possible to simulate a virtual dynamometer, which is able to evaluate the NVH, durability and efficiency performance within the same software environment, for not only a nominal design, but also factoring in manufacturing variation.

Taken a step further, various manufacturing processes may also be evaluated within the context of mass-production. Figure 3 shows such a gear whine prediction exercise, factoring in gear micro-geometry variation due to both a shaving and grinding process, and comparing

the results to a tonal noise target directly related to passenger compartment subjective ratings.

A quick review of the plot shows why gear whine issues may emerge during the critical launch phase. Note the nominal designs all reside below the defined tonal noise target. This is a normal expectation, since prototype gears are often watchfully ground or shaved with non-production tooling, with the intention of producing gears as close to the print design as possible.

But, if the effects of the manufacturing variation are factored in for the shaving process, it's clear that even with all dimensions well under control, a certain percentage of the production population will exceed the allowable tonal noise limits. Alternatively, the predicted noise performance of the population using the grinding tolerances will be under the target.

The purpose isn't to show that grinding is required; the purpose is to show a methodology factoring in relevant

# NACHI



## Products for the Aircraft Manufacturing Industry



**Christmas Tree Forms Broach**  
Create highly accurate form on turbine rotor disk blade of aircraft, ships and generators.



**Surface Broaching Machine**  
High performance and speed production of gas turbine rotors.



**Gear Tools Division**  
Visit Our New Production Facilities ~  
717 Pushville Rd.  
Greenwood, IN 46143

**Dave Petrimoulx**  
586-764-2263  
dpetrimoulx@nachiamerica.com

**www.nachiamerica.com**

population performance when making critical design and manufacturing process decisions, as early as possible. If the program direction from the example is to use shaving, a re-design to improve transmission error is easier to implement before the design freeze and tool-ordering dates. This variation information is practically impossible to acquire using test or, within a certain range of uncertainty, using “experience” only. The advanced CAE tools improve the OEM’s ability to make smarter choices for prototype builds and subsequent testing by pinpointing critical features and identifying worst-case production assemblies, in addition to predicting nominal performance, so the testing can better represent the full range of production possibilities.

### Troubleshooting 101

Invariably, despite the best efforts of both the experience-based approach and the up-front-CAE approach, transmission and axle gear whine issues will often emerge. Complicating the engineering challenge is the trend towards development of traditional multispeed automatic transmissions, with complexity well beyond previous hardware generations, and of single- and two-speed transmissions for electric vehicles, with pitch-line velocities approaching or surpassing those usually associated with superchargers and other high-speed gearing applications. Understanding how the advanced CAE tools can best be used for addressing a current production gear whine issue will help both product and manufacturing engineering teams resolve the issue at hand by using a physics-based approach for developing effective countermeasures.

But first, when presented with an automotive transmission gear whine problem, for instance, the intelligent investigator will ask a series of questions, intended to help focus on the area of greatest concern for development of robust, representative CAE drivetrain models. The questions for an automotive application are provided here for consideration, and can easily be adapted for any gearbox in any industry.

### Automotive Transmission/ Transaxle Gear Whine Standard Troubleshooting Questions

1. What is the nature of the NVH problem? Is it tonal noise?
2. If yes, does it track with engine speed or wheel speed?
3. FWD, RWD-based?
4. If you completely disconnect the shift cable from the transmission/transaxle, does the noise diminish? Show data. Be careful not to run anyone over!
5. Is the tonal noise present in all gears or just some gears?
6. Drive, coast or cruise/float conditions?
7. Is it sensitive to throttle position (gear train load)?
8. Is this a current production vehicle, pre-production/prototype?
9. URGENCY
  - a. How urgent?
  - b. Holding up launch?
  - c. Warranty costs?
10. All vehicles or some vehicles?
11. If this is a current production vehicle, was the gear whine quiet at launch, then it came on recently? Or, was it always present?
12. For the current gear whine issue, are the gears made to print? Show data.
13. Can you identify a “best of the best” (BOB) and “worst of the worst” (WOW) vehicle?
  - a. Swap transmissions. Does the whine follow the transmission or the vehicle?
  - b. If it follows the transmission, tear down the noisy transmission and re-build it. Is the noise still present at the same levels? If so, swap out the suspect gears. Is the noise still present?
14. Tell me about the transmission/transaxle configuration
  - a. Manual
  - b. Automatic
  - c. Dual-clutch transmission
  - d. Are you sure the noise is not: Power-take off
  - e. Are you sure the noise is not: Transfer case
  - f. Are you sure the noise is not: Axle
  - g. Are you sure the noise is not: engine accessory related
15. Does the noise get worse/better/same with temperature?
16. Is the same transmission/transaxle used in another application? Such as a different model, etc. Is the WOW or noisy transmission also noisy in this other application?
17. For FWD, if the noise emerged recently and not always, *something changed*. Was it the half-shafts? Wheel hubs? Mounts? Sound package? Shift cable? Change suppliers/materials on *any* of the above? Are you sure? Sometimes a part may be assigned the same number, and look the same, but tolerancing/materials could be different.
18. Any End-of-line control in transmission/transaxle plant? Gear quality SPC charts? Gear inspections?
19. What is the gear manufacturing process? Did anything change?
20. IMPORTANT: what is the noise path from the gear mesh to the passenger compartment? Are you sure? Show data.
  - a. NPA techniques: inverse matrix, dynamic stiffness
  - b. Poor man’s NPA: various disconnects/wraps
21. Are sidebands present? Spacing?
22. Does the noise occur at a single speed/frequency (“peaky”), or is it present across all speeds/frequencies, or both?

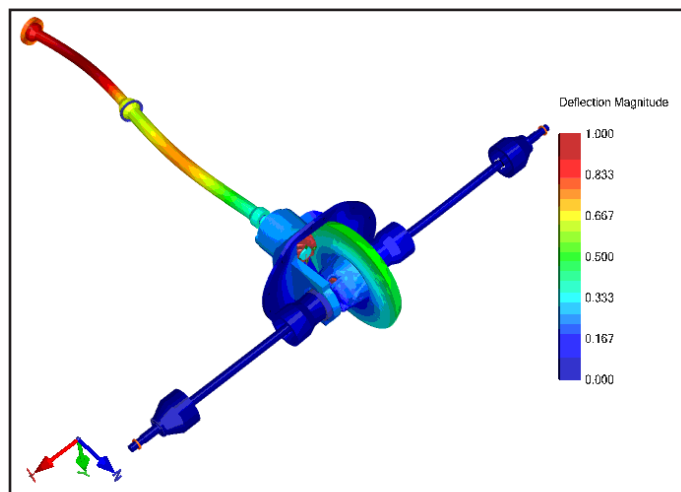


Figure 4 Mode Shape Analysis in RomaxDESIGNER



23. If you perform a neutral engine run-up, is the noise present?

The responses to the questions above will dictate the type of CAE model the investigator needs to create, and, actually establish if the tonal noise is even related to the transmission in question. Often, tonal noise from other sources is confused with transmission noise. If the NVH issue is indeed gear whine, and is present in all transmissions, and not just a few, then the fundamental issue could very well be related to the basic gear design. If limited to only a few transmissions, then the issue could be a special cause in manufacturing, such as an emerging tooling or assembly issue, excessive heat treatment distortion, material quality issues, etc. The CAE approach would be quite different either way.

Likewise, the issue could be related to a changing vehicle path, such as a transmission mount re-design for durability issues, resulting in less isolation for housing vibration; many gear manufacturing engineers have spent many long hours “fixing” gears due to vehicle issues and the application of “ear to gear” engineering as previously explained. The questions above help the troubleshooting team focus on the physics of the problem, not the politics.

A few basic guidelines for creating a robust and representative CAE model of the transmission for gear whine analysis:

**1. Model what is tested; never test what is modelled:** A drivetrain CAE tool capable of analyzing the entire transmission system, including gears, bearings, and housings should be used, especially for planetary-based or multi-mesh drivetrains (Ref. 5). This includes full tooth topologies from multiple teeth from each gear, in order to perform an accurate non-linear gear contact analysis. All flexible elements should be properly modelled with dynamics-quality meshes, including the housing, carriers, ring gears, and shafts for planetary-based transmissions. Carrier pinion spacing errors, gear pitch errors, component eccentricities and concentricities related to assembly variation, and accurate bearing geometries are all critical pieces of information required to build a representative drivetrain dynamics model with proper gear and bearing contact mechanics.

**2. Boundary Conditions:** The drivetrain CAE model should include representations of the boundary conditions that match the actual hardware (Refs. 6, 7). If test-based evaluations are to be performed in-vehicle, on a dynamometer, or in some cases, using the end-of-line test system, then the CAE model needs to perfectly reflect the upstream and downstream hardware in order to properly capture the drivetrain dynamics. The extent of the required boundary conditions will vary, depending on the system under

investigation. See Figure 4 for an example.

**3. Customer-Derived Metric:** The CAE predictions should tie in directly with customer-derived metrics based on an NPA study, such as radiated noise, mount vibration, or output shaft torsional vibration, used in conjunction with derived tonal noise targets based on passenger compartment response. Knowing the magnitude of the required reduction in noise or vibration is important to the development of effective countermeasures.

ORIGINAL SWEDISH STEEL

PURE POWDER - PURE POWER  
**ASP**<sup>®</sup>  
ERASTEEL  
FOR PREMIUM TOOLS

DESIGNED & MANUFACTURED ONLY BY  
**ERASTEEL**

FOR MORE INFORMATION ON ASP,  
ERASTEEL'S UNIQUE RANGE OF POWDER METALLURGY HIGH SPEED STEELS,  
CONTACT: ERASTEEL INC, TOLL FREE (800) 365 1152

[www.erasteel.com](http://www.erasteel.com)

If used effectively in a transmission product development process, the same up-front CAE tool used for establishing the fundamental design can also be used for troubleshooting unexpected hardware issues. This assumes the investigator knows the correct questions to ask, and like Tesla suggested, is able to properly interpret the responses in terms of energy, frequency and vibration. ⚙️

## References

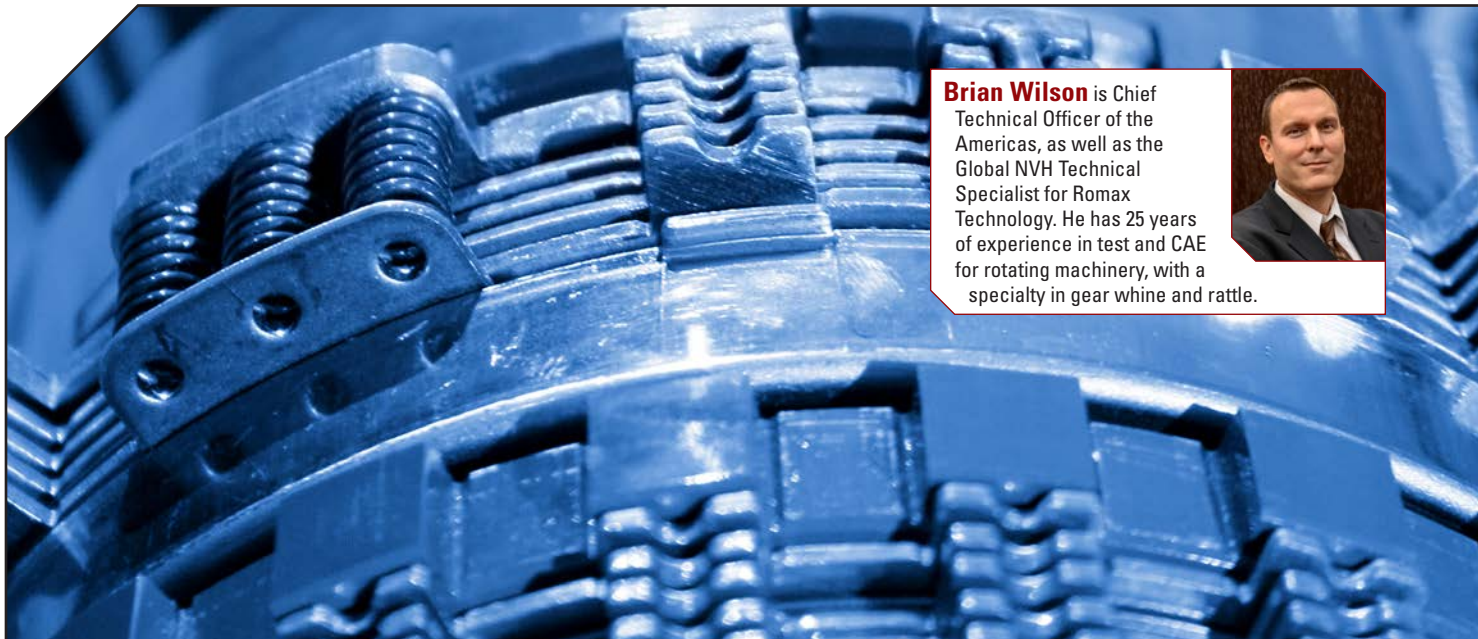
1. Zwicker, E. and H. Fastl, *Psychoacoustics: Facts and Models*, Springer-Verlag, 1990.
2. Blommer, M. and M. Clapper, "Masking Perception Analysis Software (MPAS) for Tonal Noise Setting in Powertrain NVH," SAE 2003-01-1500.
3. Williams, J. S., G.C. Steyer and J. Ditman, "Transmission Tonal Noise: Experimental Analysis of the NVH Characteristics Which Influence Vehicle Sound Quality," *Proceedings of the IMAC XIV*, Feb. 1996.
4. Abe, T., Y. Cheng, K. Nowaczyk and B.K. Wilson, "Practical Methods for Managing the Gear Whine Phenomena," *Proceedings of ASME 2007 10th International Power Transmission and Gearing Conference*, Las Vegas, Nevada, USA.
5. Abe, T., Y. Cheng, M. Felice, J. Pears, M. Platten, A. Smith and B.K. Wilson, "Predicting Variation in the NVH Characteristics of an Automatic Transmission using a Detailed Parametric Modeling Approach," SAE 2007-01-2234.
6. Jamaluddin, R., E. Stilwell, and B.K. Wilson, "Boundary Conditions Affecting Gear Whine of a Gearbox Housing Acting as a Structural Member," SAE Paper 2009-01-2064.
7. Wilson, B., G. Peterson, A. Kulkarni and A. Kanase, "CAE Techniques for System Analysis of Hypoid Gearset Vibration," SAE Technical Paper 2011-01-1502.



For Related Articles Search

noise

at [www.geartechnology.com](http://www.geartechnology.com)



**Brian Wilson** is Chief Technical Officer of the Americas, as well as the Global NVH Technical Specialist for Romax Technology. He has 25 years of experience in test and CAE for rotating machinery, with a specialty in gear whine and rattle.





NLX SERIES | UNIVERSAL TURNING MACHINES

# NLX 2500I700

## Best seller for universal turning and milling.



**CELOS<sup>®</sup>**  
from DMG MORI

### NLX SERIES HIGHLIGHTS

- + **Box ways on all axes** with optimal damping & dynamic rigidity
- + **Integrated coolant circulation** through machine bed for improved thermal stability
- + **BMT<sup>®</sup> turret** (Built-in Motor Turret) for best-in-class milling performance

### APPLICATION EXAMPLES

**Hydraulic valve // Fluid power**  
Material: S45C  
Dimensions:  $\varnothing$  4.7 × 3.9 in.  
Production time: 30 min., 35 sec.

**Guide bushing // Automotive**  
Material: S45C  
Dimensions:  $\varnothing$  3.1 × 3.9 in.  
Production time: 13 min., 29 sec.



1-855-364-6674

Support around the clock!



Technical information & brochures  
available at: [www.dmgmori.com](http://www.dmgmori.com)  
or through your local DMG MORI USA representative

**DMG MORI**

# Gleason

**THE FUTURE'S ARRIVING...  
DON'T MISS IT**



## **GEAR SOLUTIONS FORUM**

Rochester, NY USA September 23-24, 2015

**SOLUTIONS FOR CYLINDRICAL AND BEVEL GEARS OF ALL TYPES AND**

✓ Bevel Gear Solutions,  
Up to 2,500 mm

✓ Cylindrical Gear Solutions,  
Up to 10,000 mm

✓ Metrology Solutions,  
All Types of Gears,  
Gear Tools

✓ Cutting Tools and  
Workholding Solutions,  
All Processes

**For worldwide sales locations and additional information, visit:**



# NS

**It's the single most important gear technology educational event of the year.** With the arrival in September of our 4th Gear Solutions Forum, visitors will spend two full days learning about many of the new technologies that will shape the future of gear manufacturing.

You'll experience:

- ✓ Dozens of live machine demonstrations
- ✓ International experts lecturing on the most important gear production issues
- ✓ Networking opportunities with peers, partners, suppliers.

*Get a head start on the future.*

*Get the details at:*

[www.etches.com/gleasongsf2015](http://www.etches.com/gleasongsf2015)



Your exceptional 2-day learning experience covers bevel and cylindrical gear process breakthroughs, productive new automation concepts, 'smart factory' innovation...and much more.

## SIZES, EVERY PROCESS

- ✓ Global Services, 250 Factory-Trained Personnel in 30 Countries Worldwide



[www.gleason.com](http://www.gleason.com) • [sales@gleason.com](mailto:sales@gleason.com)

# The Importance of Integrated Software Solutions in Troubleshooting Gear Whine

Paul Langlois

**NVH – noise, vibration and harshness – is a key issue in the design and development of modern transmission and driveline systems.** A combination of regulations and consumer expectations drive a demand for reduced noise in all drivetrain components. Further demand is driven by the growing trend towards EV and HEVs where noise from internal combustion engines is intermittent or no longer present and the contribution of transmission noise to overall vehicle noise becomes dominant, making it more difficult to achieve customer satisfaction. So how do these problems occur? How can they be controlled? And what role can integrated software play in the troubleshooting process in order to obtain efficient and effective solutions?

## Gear Whine Analysis Requires a System Level Approach

Gear whine is an NVH phenomenon most commonly sourced from transmission error (TE) at engaged gear meshes. Theoretically, an infinitely stiff gear set with perfect involute form and no misalignment would transfer angular velocity exactly in accordance with the designed ratio. However, in reality, no gear is perfect and, for example, tooth bending and misalignments caused by deflections of the system contribute to real gears not performing to this ideal. TE is the difference between the angular position that the output shaft of a drive would occupy if the drive were perfect and the actual position of the output (Ref. 1). Other potential, but less common, sources of gear whine whose fundamental frequency is also at once-per-tooth include axial shuttling forces — where the axial location of the resultant force varies through the mesh cycle, resulting in a varying moment on the gears; and friction forces from the relative sliding at the gear mesh (Ref. 2).

Transmission error can be considered a periodic relative displacement at the gear mesh in the line of action caused

by less-than-ideal meshing conditions. The TE can dynamically excite the transmission through a path from the gear mesh, through the shafts and bearings and into the transmission housing. Gear whine is the name given to the resulting tonal noise radiated from the housing or transmitted from the housing to be radiated elsewhere. Gear whine should therefore not just be considered a *gear* problem; it is a *system* problem with the gears as the exciters of the system.

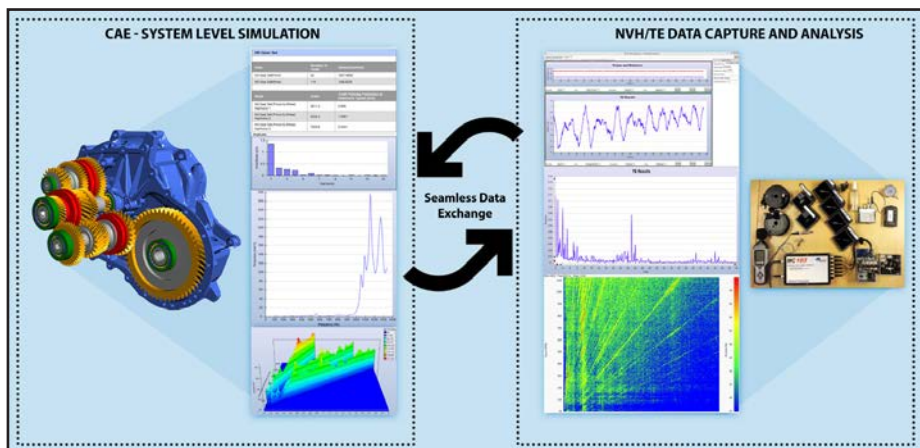
As a typical source-path-responder dynamic phenomenon, gear whine issues can be difficult to troubleshoot. It is often considered that the solution to gear whine can always be found by optimizing the gear microgeometry to minimize the excitation. Although controlling transmission error will reduce gear whine, and can often be the best approach to doing so, a gear mesh with minimal transmission error may still be a cause of gear whine issues if the rest of the system is highly sensitive to excitations at the gear mesh. Each stage of the process should, and may have to, be considered in the search for a potential solution. Further, by increasing the solution space to include the optimization of gear macro geometry for gear whine and via consideration of the stiffness and mass of the supporting structure and housing, greater improvements can be achieved.

As gear whine is a system-level NVH issue, for simulation of these contributions and virtual testing of potential solutions a full system level modelling and analysis approach is required.

## A Full Testing and Simulation Methodology

To solve NVH problems, a combination of experience and the right tools are required to find solutions with minimal cost and timescale. An efficient NVH troubleshooting methodology requires a process where accurate measurements and detailed CAE simulations can be performed side by side and data processed and communicated error-free between testing and analysis teams using integrated software solutions. Integrated software solutions for gear whine NVH are those that can perform measured data capture and analysis and all relevant system-level simulations in one integrated environment with seamless data transfer — such as those, for example, offered by SMT (Fig. 1). The purpose of this article is to discuss the role these integrated software solutions play in this process, with the understanding that it is beyond the scope of this article to describe the complete problem-solving methodology.

The first recommended step would be to check manufacturing and assembly



**Figure 1** An integrated software solution for gear whine combining measured data capture and analysis with system-level simulations in a single environment with seamless data transfer.



# POWERFUL CONNECTIONS

OCTOBER 20-22, 2015  
DETROIT, MI  
COBO CENTER

## SAVE THE DATE

FOR THE DRIVE TECHNOLOGY SHOW OF THE YEAR!

**GEAR EXPO 2015** brings together the full range of experts — design, manufacturing, application engineering — all in the same place — **Cobo Center, Detroit, October 20-22.**

From a single gear to complex drives, **GEAR EXPO** covers it all...

- **More exhibitors** — from gear making machines to systems integrators.
- **More education sessions** — from metallurgy and geometry to maximizing power density.
- **More attendees** — buyers and makers from automotive, construction, mining, agriculture — wherever high-performance drives are critical.
- **More solutions** — meet the experts and evaluate your capabilities.

**GEAR EXPO 2015 is the place to be.**

- Make powerful connections.
- See the latest technology in action.
- Get the inspiration you need to take your products to the next level.

Improved drive technology is critical to achieving higher efficiencies and longer service life. All the information and answers you need will be at **GEAR EXPO 2015.**



Register today at  
**[www.gearexpo/GETech](http://www.gearexpo/GETech)**

Use code GETECH when registering.



quality. If quality is poor, e.g. — outside the required tolerances — then TE can be high and these issues need to be resolved before steps in addressing the design are taken. Software can play an important role even at this stage, where cylindrical gear manufacturing simulation achieved by SMT MASTA software (Ref. 3) can help improve manufacturing quality and resulting TE. In addition, the same software can be used to carry out parametric studies to identify and adjust manufacturing tolerances to reduce assembly-to-assembly-related TE variation.

Software plays two main vital roles in the further troubleshooting process: 1) within the test environment, where high-fidelity data logging is required to capture test results and where results need to be processed using data analysis tools to effectively analyze the measurements and identify the features of interest and the main contributors from the system to those features; and 2) within the simulation environment where state-of-the-art, system-level simulation tools are required to perform a number of simulations of aspects of the system — details of which will be described later in this

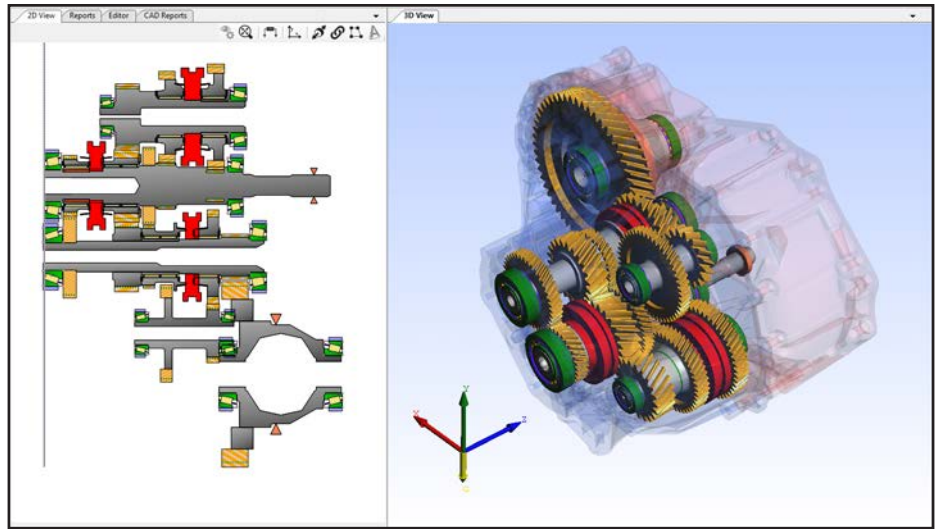


Figure 2 A system-level transmission simulation model.

article. Correlation between simulation and test can be made, and the simulation model then used as a virtual environment for assessing the effect of potential solutions on all requirements and targets. Changing component parameters in a virtual environment is a quick, low-cost approach that minimizes the need for expensive and time-consuming hardware trial-and-error loops.

Integrated software solutions allow all these tasks to be performed in a single software environment. At the testing stage, data from proprietary, portable hardware for both noise, vibration and transmission error measurement can be captured, post-processed, and analyzed, using in this case SMT's TE and NVH data capture and analysis software — MEASA. Further, the measured data analysis tools can be linked to SMT's



**PENTAGEAR  
PRODUCTS**

## Gear Metrology Systems

### NEXT DIMENSION® Gear Measurement Systems



**ND300**



**ND165**

- Analytical Gear Inspection
- DOB/DOP Gages
- Double Flank Testers
- Single Flank Testers
- Gear Burnishing Machines
- Gear Deburring Machines
- Master Gears
- Spline Gauges
- REPOWERED Gear Inspection Machines
- Metrology Services
- Contract Inspection

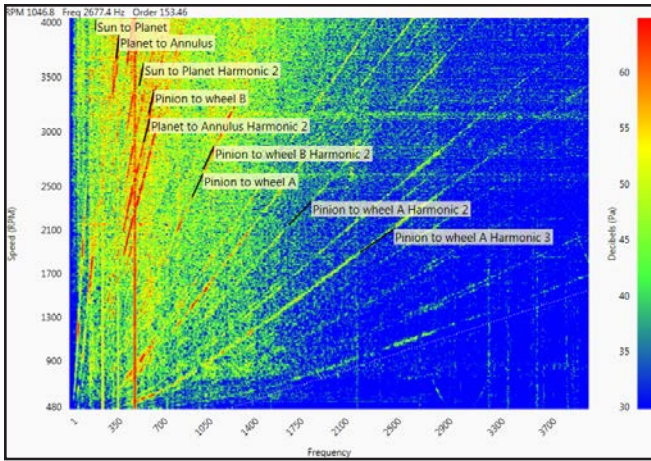
**Windows7 64 Bit OS • Minimal Operator Training Required • Intuitive User Friendly Software**

6161 Webster Street, Dayton, OH 45414  
www.gearinspection.com

Email: sales@pentagear.com

Tel: 937-660-8182  
fax: 937-660-4511





**Figure 3** Measured noise displayed as a waterfall plot with excitation orders automatically labelled via data from a system simulation model.

mentioned transmission design and analysis software, *MASTA* (Ref. 3), where orders from potential excitations within a corresponding analysis model of the system can be passed to easily identify contributions from transmission components while processing measured data.

Within a simulation environment, *MASTA* allows for analysis of many aspects of the problem; a single model of the system is easily built within the

to calculate deflections of the system and their effect on durability of components; quasi-static analyses of the loaded gear mesh contact conditions to calculate contact stresses, root stresses, transmission error and shuttling forces; modal analyses of the full system to calculate system-natural frequencies, mode shapes and modal energy content; and gear whine analyses of the full system to cal-

software (Fig. 2). This single set of parameterized inputs can then be used to perform a number of analyses for a number of failure modes and phenomena of interest, using automatically constructed analysis models of differing levels of fidelity. Analyses of interest for gear whine include: static analyses of the full system under a number of operating loads

calculate the dynamic response of the system to excitation by transmission errors.

### Test Data Capture and Data Analysis Software

For gear whine issues typical measurements considered include noise measurements via microphones, casing vibration measurements via accelerometers, and transmission error measurements via angular encoders.

Measurements of gear whine should include tests performed in-vehicle that capture the full operating range through, for example, vehicle accelerations at different throttle levels and vehicle coast-down. Further dyno rig tests should be performed to isolate and understand transmission and driveline noise sources. Care must be taken in correlating any rig test results with those of vehicle tests and the original subjective noise problem. Different boundary conditions on the rig, as compared to in-vehicle, can significantly change the dynamics of the system and subsequent frequency content of problem areas (Ref. 4).

Accurate data acquisition requires calibrated microphones and acceler-



## HANS-JÜRGEN GEIGER

Maschinen-Vertrieb GmbH

Metzingen / Stuttgart



**High quality used machine tools from Germany since 1968.**

Please visit our showrooms:  
7000 sqm display area with more than 600 machines in best condition.

**HANS-JÜRGEN GEIGER**  
Maschinen-Vertrieb GmbH  
James-Watt-Straße 12  
D-72555 Metzingen (Germany)  
Phone +49 (0) 7123 / 18040  
Fax +49 (0) 7123 / 18384  
E-Mail: geiger@geiger-germany.com

**MIKRON**  
**DMG | DISKUS**  
**TBT | HELLER**  
**ELB | NAGEL**  
**SCHAUDT**  
**KEHREN**  
**KARSTENS**  
**MIKROSA**  
**INDEX | ZEISS**  
**BOEHRINGER**  
**GILDEMEISTER**  
**SCHÜTTE**  
**AGIE | SCHULER**

Gear cutting machines:

**LORENZ | HURTH**  
**PFAUTER | KAPP**  
**KOEPFER | NILES**  
**LIEBHERR**  
**REISHAUER**  
**LINDNER**  
**KLINGELNBERG**  
**GLEASON**  
**WMW**



[www.geiger-germany.com](http://www.geiger-germany.com)

b-werk.de

ometers and high-fidelity data logging. Further, an accurate speed signal is required for analysis of component orders. Measurement data can be captured and analyzed using *MEASA* data capture and analysis software. Data analysis tools allow the user to process the data in a number of ways. By linking to a model of the transmission system under consideration, potential excitation orders and the components and harmonics to which they correspond may be imported into the data analysis tools to allow easy identification of the main contributions to specific orders and to the total noise/vibration content. Critical plots given include waterfall plots and order cuts giving quantitative results for the noise due to specific sources and their prominence with respect to total noise (Fig. 3).

Although less common than noise and vibration measurements, the source of gear whine — loaded transmission

error — can also be measured using angular encoders. For a transmission or driveline system on a test rig, encoders may be placed on the input and output shafts in order to measure the whole gearbox, or may be placed straddling a sub-system to measure just that sub-system. As with noise and vibration test results, TE test results may be captured and analyzed using *MEASA*. Fourier analysis can be performed to identify the contributions from different stages and angular TE values can be converted to linear via the base radius values for the gears. A link to a model of the system allows import of gear mesh orders and their harmonics for easy identification within the data analysis tool.

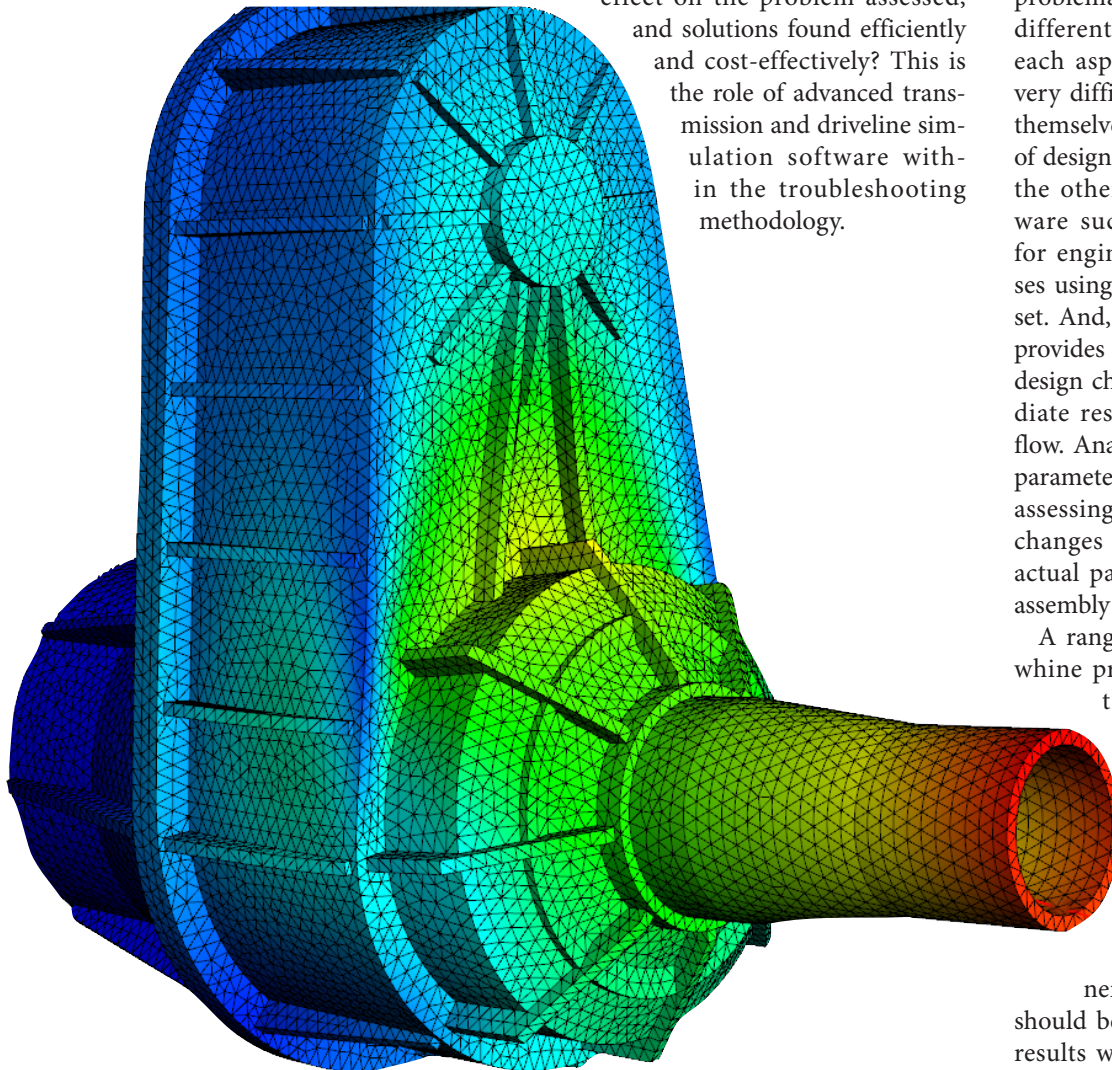
Using these measurement and data analysis techniques, the nature of the noise issue can be quantified and the contributions from the potential excitations in the transmission identified. But how can design changes be made, their effect on the problem assessed, and solutions found efficiently and cost-effectively? This is the role of advanced transmission and driveline simulation software within the troubleshooting methodology.

## Full System Simulation

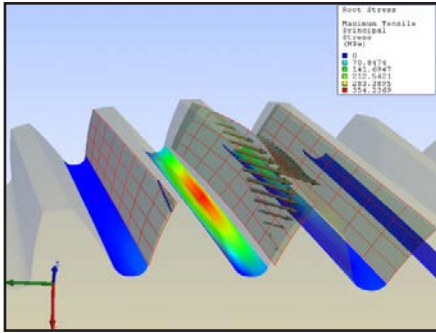
Once a gear whine issue has been identified and the contributions clarified via measurement and data analysis techniques, simulation software plays a vital role in efficiently assessing potential solutions. As gear whine is a system-level issue, where solutions may be considered from gear macro geometry design, gear microgeometry design, system stiffness and mass properties and the transmissibility of TE to the casing, state of the art system-level software is required to be able to perform various analyses of interest. Design changes need to be assessed effectively — not just for their effect on the noise problem at hand — but also for other considerations of importance in the design process so as, for example, not to compromise durability.

Such durability, loaded tooth contact and dynamic response analyses may be performed using standalone commercial FE packages. However, this approach is problematic as it requires models with different levels of fidelity to calculate each aspect. What's more, models are very difficult to set up and do not lend themselves well to analyzing the effects of design changes easily and quickly. On the other hand, integrated CAE software such as *MASTA* provides tools for engineers to perform these analyses using a single model and parameter set. And, model generation is rapid and provides the flexibility to make complex design changes on the fly, seeing immediate results within a seamless workflow. Analyses are fast enough to enable parameter space DOE studies, including assessing the robustness of any design changes to the expected variability in actual parts due to manufacturing and assembly tolerances.

A range of analyses relevant for gear whine problems can be performed on the system-level model. To begin, a number of static analyses are usually performed covering the operating range to calculate deflections of the system, including misalignments at gear meshes, and durability results for components. Baseline durability results should be obtained and compared with results when design changes are made



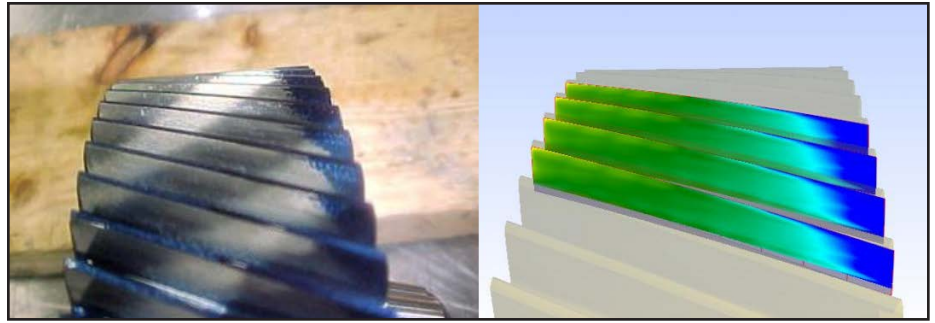




**Figure 4** Hybrid FE and Hertzian-based loaded tooth contact analysis.

to check that no compromise in durability is introduced. The system deflection model consists of an FE-based model where shafts are considered as Timoshenko beam elements; bearings are represented via a bespoke non-linear contact formalism, taking into account the full geometry details; clearances, preloads, etc., gear meshes are represented as bespoke non-linear contact models; and housings and complex asymmetric shafts are included via stiffness and mass matrices obtained via dynamic reduction from a full FE model of the geometry. Durability results for bearings, gears, shafts and other coupling components are obtained by passing deflections and loads from the analysis results to implementations of the relevant international standards (Refs. 5–7).

Although it should be noted that the solution to gear whine does not always lie in optimizing gear microgeometry, this is often the first area of investigation due to its relative ease. Further, if late in the development process, this is often the easiest option to implement due to the minimal change to manufacturing processes and tooling required. Calculation of TE can be performed using a loaded tooth contact analysis (LTCA). Torque, misalignment, gear macro and microgeometry are used as inputs. It is very important to use an accurate LTCA in order to get an accurate calculation of TE. A hybrid FE and Hertzian, contact-based formalism are used to accurately capture the stiffness at each contact location while providing a fast calculation suitable for assessing microgeometry parameter changes and robustness to tolerances (Fig. 4). Such a calculation is comparable in accuracy to a full FE contact analysis while being many orders of magnitude faster. An FE



**Figure 5** Measured and simulated loaded contact patterns.

model of the gear macro geometry is built automatically in the software and used to obtain the overall bending and base rotation stiffness of the gear teeth, with consideration made for coupling between teeth. This bending stiffness is combined with a Hertzian line contact formalism to calculate the overall stiffness of any potential contact points. Potential contact lines are split into strips and force balance and compatibility conditions are formulated and solved (Ref. 8) to calculate the load distribution across the mesh and the transmission error for the input torque. This LTCA can be used to optimize gear microgeometry and macro geometry for minimal transmission error. Consideration must be given to the entire operating range of loads and the robustness of the proposed design to variation in load and misalignments, as well as variation in gear microgeometry within the manufacturable tolerance range.

It is often assumed in the analysis workflow described above that the deflections of the system affect the tooth contact — but the tooth contact conditions do not affect the deflections of the system. Hence, as above, a calculation of misalignments is first performed using a static system-level model, and these misalignments, assumed constant throughout the mesh cycle, are used as inputs into the tooth contact calculation. This assumption is often — but not always — valid. In a number of important cases, such as the tooth contact conditions of a planet gear, the interaction between the two meshes of the planet means that the system deflection and tooth contact conditions need to be solved in a coupled calculation. In such a calculation the assumption of a fixed misalignment throughout the mesh

cycle is removed and the variation in misalignment is calculated. Further, for planetary systems where contact conditions may vary, as the planet carrier rotates, such a coupled calculation is required. The software solutions discussed here also provide such a calculation.

Tooth contact analysis results can often provide good validation that the analysis model is set up and performing correctly. A contact patch test is a relatively easy and common test to perform and contact patch test results can be compared directly against analysis results (Fig. 5). If correlation is good, this gives confidence in the analysis model, implying that calculated misalignments, microgeometry inputs, and calculated load distribution under the tested loads are accurate. Further, if TE measurements have been performed, measured and calculated, TE can be directly compared.

Analysis of the dynamics of the system can be performed via modal and harmonic response analyses. For a modal analysis of the system at a given input load, a linearized model of the non-linear static analysis model at that load is automatically built. The natural frequencies and corresponding mode shapes can therefore be calculated for different operating loads. Campbell diagrams can be used to identify potential excitations of the system where, for example, gear mesh frequencies or their harmonics cross the natural frequencies of the system. Further, the energy content of the mode shapes can be visualized and investigated to identify the main contributing components to those potential resonances (Fig. 6). A target would be to minimize the number of natural frequencies within the operating range

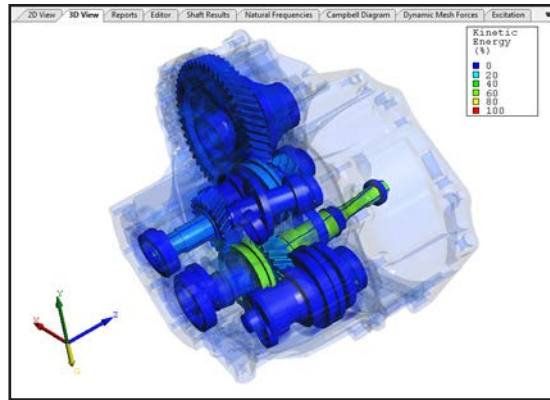
while also separating any way in which do lie within the range from each other.

The method of calculation of the system response to the transmission error introduced by Steyer et al (Ref.9) can be used to calculate the casing acceleration at virtual accelerometer locations. As the excitation is periodic and the stiffness around the loaded condition can be considered linear, the calculation can be performed very quickly in the frequency domain. Static transmission error is the assumed excitation input of the system and the first step is to calculate the dynamic force at the gear meshes, which leads to a relative displacement at the mesh given by this transmission error. This force is known as the dynamic mesh force that is calculated from the dynamic compliances at each side of the gear meshes. The dynamic mesh force is then applied as an excitation to the system model to calculate the response at any point on the system to this excitation. Waterfall charts can be plotted of dynamic response for any point on the model (Fig. 7) and compared with accelerometer and/or microphone data obtained via noise and vibration tests.

Once a virtual model is correlated with test data, contributing modes to problem frequencies can be identified via the waterfall charts and natural frequencies. Then, the contributing components to those modes can be identified with mode shapes and energy contributions. With the results obtained, the design of these components can be adjusted to improve the dynamic response of the analysis model. Once the desired results are obtained, the design changes can be implemented on a prototype and tested again to confirm the expected improvements.

Benefits of an Integrated Software Approach to Troubleshooting Gear Whine

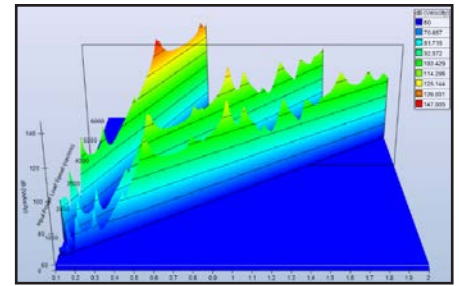
- Reduced product development time by targeting solutions in a virtual testing environment.
- Reduced product development cost by minimizing component testing.
- Allows production variation to be investigated and minimized prior to product launch.



**Figure 6** Mode shape and kinetic energy content of system mode at 701 Hz.

## Summary

The development cycle of transmission systems is a complex and costly process. With increased demands for lower-noise transmissions and drivelines driven by markets such as EV and HEVs, more pressure is being placed on designers to design for low noise and for analysts to solve known gear whine issues quickly and efficiently. Quick solutions with minimal cost can be found with a combination of solid methodology, experience and the right software tools. Software plays a vital role within this process. Assessing, controlling and fine-tuning designs for gear whine within an integrated CAE environment, such as that offered by SMT, where test data capture and data analysis, together with advanced simulation methods, are seamlessly integrated, provides engineers with the flexibility and freedom to achieve new levels of quality otherwise too costly and time-consuming to achieve through physical prototyping alone. ⚙️



**Figure 7** Calculated casing response to excitation by transmission error.

## References

1. Smith, J.D. *Gear Noise and Vibration*, Second Edition, Marcel Dekker, Inc. 2003.
2. D. R. Houser, D.R. et al. "Determining the Source of Gear Whine Noise," *Gear Solutions*, February 2004.
3. [www.smartmt.com/masta](http://www.smartmt.com/masta).
4. Meinhardt, G. et al. "Correlation of Axle End-of-Line (EOL) NVH Performance and Laboratory Dynamometer Performance," *SAE 2005 Noise and Vibration Conference*, 005-01-2306.
5. BS ISO 6336-2: 2006(E). Calculation of Load Capacity of Spur and Helical Gears — Part 2: Calculation of Surface Durability (Pitting), 2006.
6. BS ISO 6336-3: 2006(E). Calculation of Load Capacity of Spur and Helical Gears — Part 3: Calculation of Tooth Bending Strength, 2006.
7. ISO/TS 16281: 2008(E). Rolling Bearings: Methods for Calculating the Modified Reference Rating Life for Universally Loaded Bearings, 2008.
8. Conry, T.F. and A. Seireg. "A Mathematical Programming Method for Design of Elastic Bodies in Contact," *J.A.M. ASME*, 2, 1971
9. Chung, C. and G. Steyer et al. "Gear Noise Reduction Through Transmission Error Control and Gear Blank Dynamic Tuning," *SAE Noise and Vibration Conference* 1999-01-1766.

For Related Articles Search

noise

at [www.geartechnology.com](http://www.geartechnology.com)

### Dr. Paul Langlois is

CAE products development department manager at Smart Manufacturing Technology Ltd. (SMT). Having worked for SMT for 10 years, he has extensive knowledge of transmission analysis methods and their software implementation. He manages the development of SMT's software products and was a main contributor to many aspects of the technical software development, such as MASTA's gear-loaded tooth contact analysis and NVH functionality.





# Hungry for More?



Everything you need to be a world-class gear manufacturer—the suppliers, the technical information and the market intelligence—can be found online

## **gear** TECHNOLOGY®

- Complete archive of back issues and articles, 1984-today
- Directory of suppliers of machine tools, services and tooling
- Product and Industry News updated daily
- Exclusive online content in our e-mail newsletters
- Calendar of upcoming events
- Comprehensive search feature helps you find what you're looking for—fast!

**FREE  
SUBSCRIPTIONS**

**[www.geartechnology.com](http://www.geartechnology.com)**

# Gear Mesh Assembly

Email your question — along with your name, job title and company name (if you wish to remain anonymous, no problem) to: [jmcguinn@geartechnology.com](mailto:jmcguinn@geartechnology.com), or submit your question by visiting [geartechnology.com](http://geartechnology.com).

## QUESTION

**When assembling a pair of gears, what is a good method for setting and checking their mesh?**

### Expert response provided by: Robert Wasilewski, Arrow Gear Company.

Proper setting of gears usually involves checking backlash and tooth contact pattern. Backlash can be checked using a dial test indicator applied to a tooth on one member of the mesh and moving that member back and forth while holding the other member still. Contact pattern checks require painting some or all of the teeth of at least one member with gear marking compound and rotating the gears to see how they contact in the marking compound.

That's the simple answer.

What do you do if you do not like the results you get? This really depends on the type of gears that you are assembling. Parallel axis gearing, spurs and helicals usually offer very little opportunity for change. Most of the time, the two supporting shafts are fixed in their relationship to each other by the location of the gearbox support bearings; all you can do is move the shafts axially in relation to each other. If the gears have crowning, the axial movement can be used to center the contact pattern. The backlash is controlled by tooth thickness and center distance. Since neither can be changed, you cannot adjust backlash; all you can do is measure the backlash in several positions to make sure whatever variation present is acceptable.

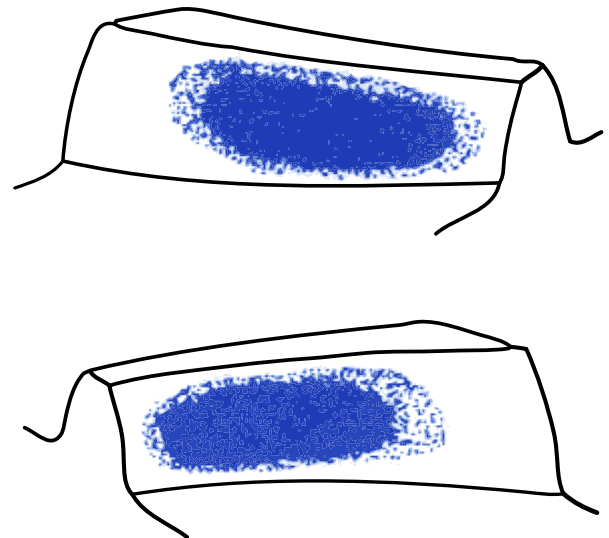
Non-parallel axis gearing is another story. While the shafts are still fixed in their relationship to each other, axial movement can greatly affect the contact pattern and the backlash. This is true for worm, hypoid and bevel gears. How do you get proper contact and backlash? By mounting the gears at the position the manufacturer made them at. Traditionally, bevel and hypoid gears have their mounting dimensions marked on each part. When this is the case you should use those dimensions by measuring the gearbox components that affect the position of the gears and calculate the thickness of any shims used to adjust their position; the shims are generally under bearing retainers or housing flanges. If shims are not in the design, components may have to be machined to adjust the gears position. The most common component to be machined would typically be a steel spacer. It is very important to note that you need to measure the individual components you are using, and do not just use the nominal dimensions from the component drawings. A little bit of adding and subtracting will show that the stack-up of tolerances from all the components can easily place the gears in the wrong position. If you measured correctly and calculated the shim or spacer width correctly, you should get the same contact

pattern and backlash the manufacturer put in to the gear set. If you are rebuilding a gearbox, do not just put back the old shims or spacers without verifying they are the right thickness.

What you cannot do is just put bevel gears together and only check the backlash. This is one of the most common mistakes made at assembly. Bevel gears can be assembled at any number of positions and still have the correct backlash, but only being at or very near the marked mounting distance will yield the correct contact pattern and backlash. By the way, you can have the correct contact pattern and not have the proper backlash too! How can that be? As you increase the ratio in bevel gears, each member begins to have a different amount of effect on the contact pattern and backlash. The pinion becomes the dominant member that controls the contact pattern, while the gear, or wheel, principally controls backlash. So as you get to higher ratios it is more important to position the pinion as close as possible to the marked mounting dimension. The wheel can be brought in to mesh to adjust backlash. Both members control backlash and contact pattern equally when the gear set is at a ratio of 1-to-1. At 1-to-1 ratio, each member must be adjusted.

If the gears are not marked with mounting distances — or it is just too difficult to measure — you have to resort to a trial-and-error method of looking at contact patterns and adjusting the components until you have an acceptable pattern and

Desirable Bearing Pattern





backlash. There are several issues with this method. If the gearbox is not designed with shims but uses ground spacers, it can become an expensive and tedious process. Also, you have to judge if the contact pattern is in fact correct. Contact patterns seldom have the nice picturesque appearance that you see in the literature. The shape and size of the pattern can vary widely from the classic elliptical pattern. If possible, request copies of the contact pattern from the manufacturer of the gears when you order them. These can be transfers of actual marking compound lifted from the tooth surface with transparent tape or photos. Transfers are best. The manufacturer may also be able to leave the pattern and compound on the gears when they ship them to you so you see exactly what it looks like on the teeth. (Make sure you record that because it will change if the gears are assembled and run again at the wrong position). You have to order all of those options; they are not customary.

The position is usually the overriding factor to look at. It is very easy to overlook a positioning error because you do not know how to interpret the appearance of the contact pattern. You need to look at contact patterns on both sides of the teeth—even if the gears only turn in one direction. Assembly people often give up before they get the proper setup.

There is a bit of a technique involved in applying tooth marking compound. Also, if you do not know what the contact pattern is supposed to look like, you need some guidance as to how to move the gears and what to look for. That is beyond the scope of a brief article like this one, but is very well documented in a national standard. ANSI/AGMA 2008-D11 — Assembling Bevel Gears — is available from the American Gear Manufacturers Association — [www.agma.org](http://www.agma.org). The document has examples of contact patterns, and what to do to correct them, as well as a detailed procedure on how to apply and use tooth marking compound. There are also detailed examples of measuring components to calculate shims, as well as tooling examples that can help reduce calculations and assembly time. The document is not only intended for the assembly room, but also gives the gearbox designer a great idea of what to provide to make assembly quicker, better and more accurate.



**Robert Wasilewski** is engineering services manager for Arrow Gear Company, and Chairman of the AGMA Bevel Gearing Committee.



# Surface Roughness Measurements of Cylindrical Gears and Bevel Gears on Gear Inspection Machines

Günter Mikoleizig

Alongside the macro test parameters on tooth flanks for profile and tooth traces, surface properties (roughness) play a decisive role in ensuring proper toothed gear function. This article addresses roughness measurement systems on tooth flanks. In addition to universal test equipment, modified test equipment based on the profile method for use on gears is addressed in particular. The equipment application here refers to cylindrical gear flanks and bevel gear flanks. The most important roughness parameters, as well as the implementation of the precise measurement procedure will also be described under consideration of the applicable DIN EN ISO standards as well as the current VDI/VDE Directive 2612 Sheet 5.

## Introduction

Alongside the macro test parameters on tooth flanks for profile and tooth traces, surface properties (roughness) play a decisive role in ensuring proper toothed gear function. The generally increased load stresses on gear teeth can only be implemented by maintaining precisely defined roughness parameters. Roughness measurements are therefore conducted on the gearing flanks in all highly developed drives, in the automotive industry, aircraft industry, or the area of wind energy drives, for example.

This article addresses roughness measurement systems on tooth flanks. In addition to universal test equipment, modified test equipment based on the profile method for use on gears is addressed in particular. The equipment application here refers to cylindrical gear flanks and bevel gear flanks. The most important roughness parameters, as well as the implementation of the precise measurement procedure will also be described under consideration of the applicable DIN EN ISO standards as well as the current VDI/VDE Directive 2612 Sheet 5.

## The Purpose of Roughness Measurement on Toothed Gear Flanks

Alongside the macro test parameters on tooth flanks for profile and flank lines, surface properties (roughness) play a

decisive role in ensuring proper toothed gear function. Unlike general functional surfaces, the particular shape (curvature) and the slide-roll effect during meshing come into play with tooth flanks. Thus the surface roughness affects the following properties:

- Flank load capacity
- Tooth root load capacity
- Wear load capacity
- Load capacity involving heavy scoring
- Lubrication conditions
- Noise behavior
- Approach behavior

When determining the gearing quality according to DIN/AGMA/ISO standards

via profile and tooth trace, an impression of the existing roughness is also obtained, but this is in no way comparable to roughness measurement performed according to the standard. The correlation is clear when the various probe elements for the measurement are taken into account, for example (Fig. 1). A standard gear measurement is performed with a 1.5 mm probe (radius 750 μm); for a roughness measurement, however, a diamond tip with a radius of 2 μm or 5 μm is used. A roughness measurement therefore measures significantly finer structures on the surfaces. Along with the macro test parameters on tooth flanks

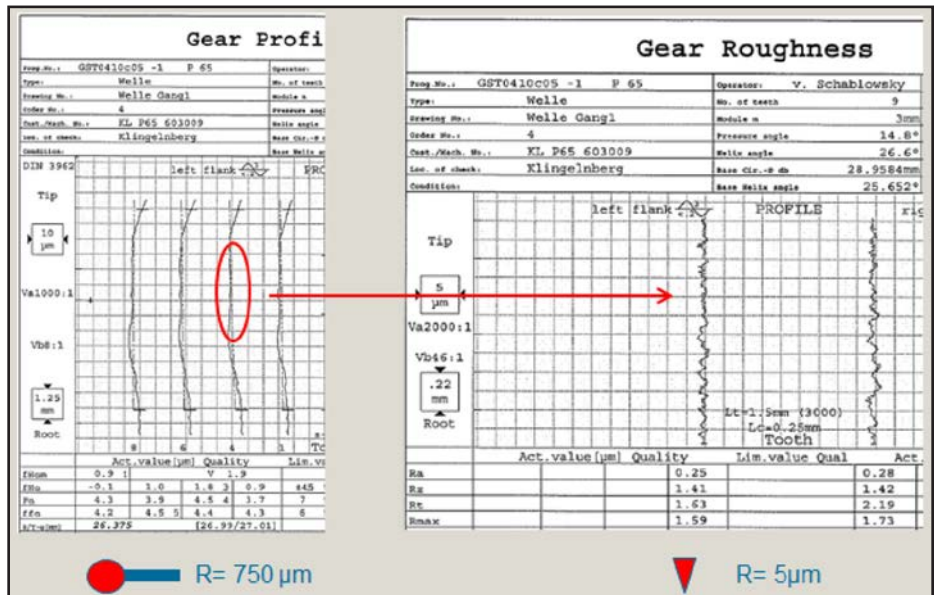


Figure 1 Comparison of measuring results.



according to the gear standards for cylindrical gears, surface properties (roughness) plays an important role in ensuring a proper toothed gear function.

## Overview of Roughness Parameters

The general roughness parameters are defined in the DIN EN ISO 4287 standard. An application of this standard for tooth flank measurements is described in the current VDI/VDE 2612 Sheet 5. In a general roughness measurement, the unfiltered P profile (Ref. 2) is obtained initially. Filtering then produces the long-wave deviation (W profile) or the short-wave deviation (R profile). The short-wave deviations form the basis for the general roughness parameters used (Fig. 2).

During filtering of the recorded profiles, DIN ISO 16610-21 specifications apply, including measuring paths and cut-off wavelength (Fig. 3).

The profiles relevant for the roughness measurement are limited by the lambda C filter (waviness cut-off) and the lambda S filter (cut-off for even finer structures) (Fig. 4).

The most important roughness parameters for flank measurements are shown in Figure 5.

The arithmetic mean roughness value  $R_a$  is the ordinate value of the roughness profile within a single measurement path  $l_r$ . The individual roughness depth  $R_z$  is the sum of the distance between the profile peak and profile valley within a single measurement path  $l_r$ . Like  $R_a$ , the averaged roughness profile  $R_z$  is determined as an arithmetic mean from the individual measurement paths.

The total height of the roughness profile  $R_t$  is the sum of the height of the largest profile peak and the depth of the largest profile valley within the measurement path  $l_n$ . The maximum individual roughness depth  $R_{max}$  is the largest individual roughness depths  $R_z$ . The stock portion  $R_{mr}$  is the ratio of the sum of the stock-filled lengths  $M_{l1}$ - $M_{li}$  for the total measuring path  $l_n$  as a percent value.

The core roughness depth  $R_k$  is the depth of the roughness core profile. The reduced peak height  $R_{pk}$  is the height determined from the peaks projecting beyond the core area. The reduced peak depth  $R_{vk}$  is the height determined

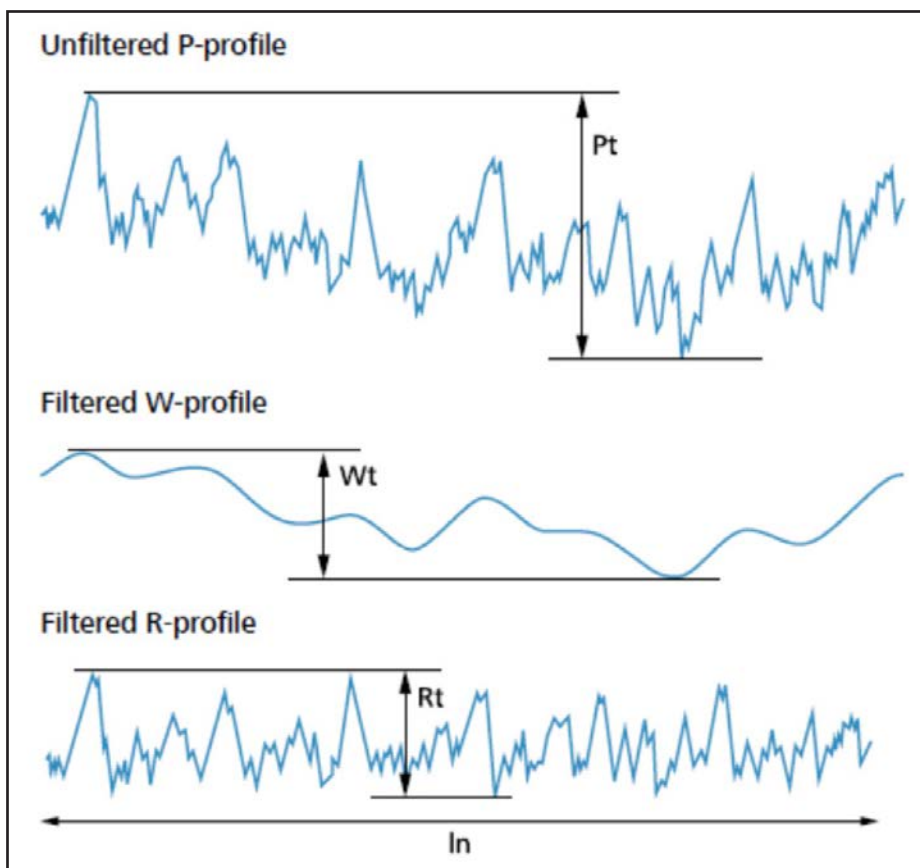


Figure 2 Division of a surface.

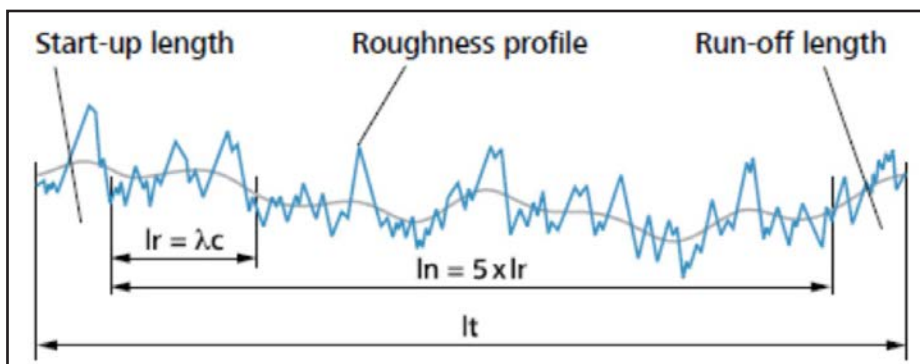


Figure 3 Evaluation lengths-cut off.

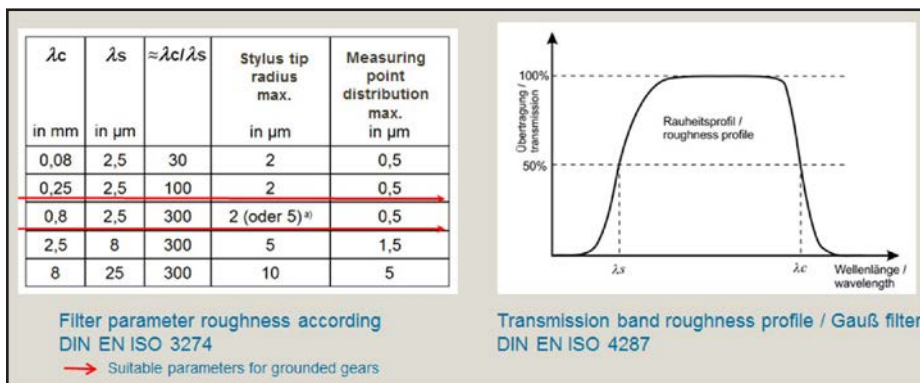


Figure 4 Filter parameters and transmission band for roughness profiles.

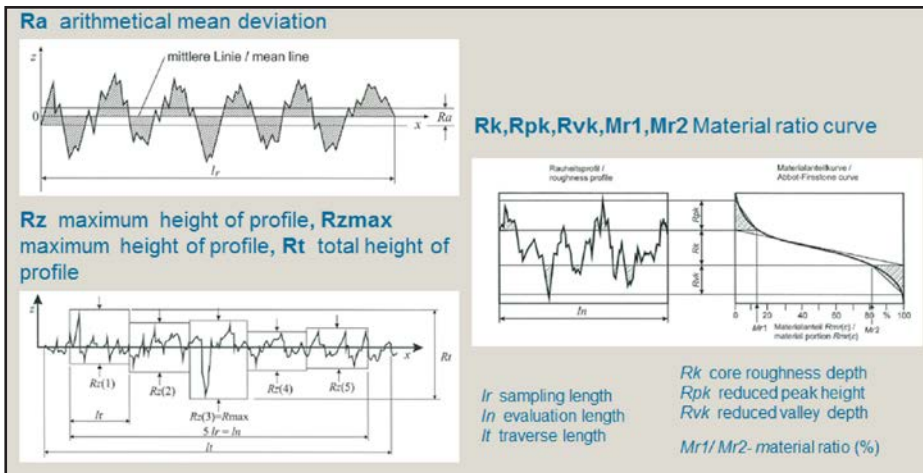


Figure 5 Roughness parameters according to DIN EN ISO 4287/13565.

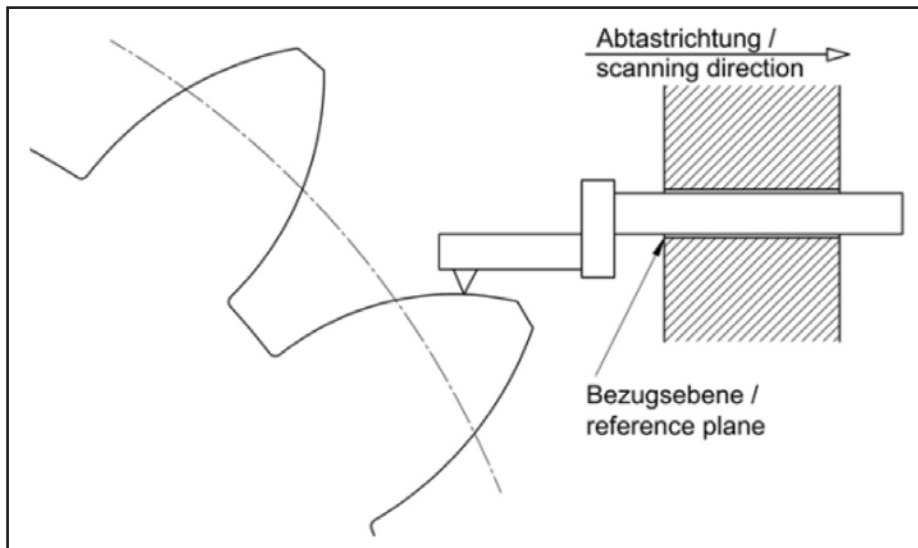


Figure 6 Skid less probing system with plane reference.

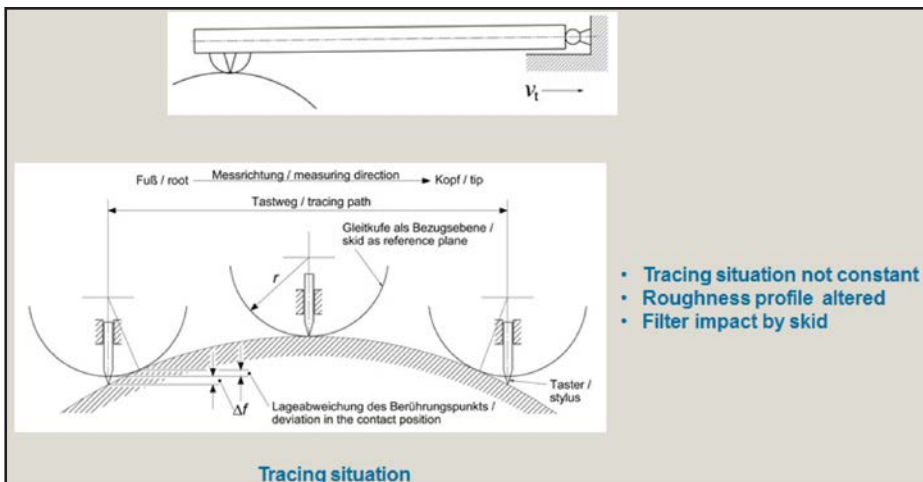


Figure 7 Probe system with side mounted skid probe (VDI/VDE 2612 Sheet 5).

for the striations extending from the core area into the stock. The parameters  $Mr1$  and  $Mr2$  of the stock percentage curve characterize the stock content at the limits of the roughness profile  $Mr$ .

### Measuring Methods and Measuring Equipment for Roughness Measurement

In the VDI/VDE 2602 directive, and the DIN EN ISO 4287 and DIN EN ISO 16610-21 standard, these are profile methods that describe the properties of the profile equipment and the general-case measurement conditions for roughness measurements of surfaces.

Skid-less probing systems and instruments with lateral skid (at the side off) are typically used to measure flank roughness (Ref. 1).

Figure 6 shows the tracing situation of a skid-less probing system in the tooth space. The profile here must be aligned as parallel as possible to the tracing direction of the test device. In the result, however, there is always a difference between the straight trace direction and the curved flank. The overall profile must therefore be corrected with a compensation arc, or residual errors must be eliminated with the lambda C profile filter. The possible trace path is limited due to the curved profile surface and the measuring range of the roughness probe.

The probing conditions of a skid system are shown in Figure 7. The side-mounted probe skid follows the profile of the tooth flank. A deviation due to changing contact conditions during the roughness measurement must be taken into account here. The deviations are relatively small, however, and are largely eliminated due to profile filtering.

For roughness measurement on cylindrical gear flanks, measuring devices with an involute reference (Fig. 8) offer certain advantages. Logging of measured values in profile generation mode on the tooth flank (involute) ensures that the probe tip is always aligned perpendicular to the surface; thus the roughness can theoretically be scanned over the entire profile length. The disadvantage of this type of contact operation, however, is that the scanning speed for measured value logging is not constant, nor is a uniform measuring point distance ensured. But



this is a minor disadvantage, resulting in measured value differences of up to 10%.

On current gear measuring centers, the involute reference is generated via CNC path control and can be used in principle in conjunction with skid-less systems and skid systems. For special profiles and bevel gear flanks with other profile forms, for instance, the CNC-guided path control can also execute reference profiles.

Roughness Measurement Procedure in Practice

The measuring conditions (Ref. 1) must first be defined in order to achieve generally comparable results. The following points must be taken into account to avoid measurement deviations:

- Probe system
- Profile filter
- Alignment of test specimen
- Environmental influences

Refer to Table 1 to select appropriate individual measurement paths and cut-off. As finish-machined surfaces on tooth flanks in particular must be tested, the highlighted values should be used preferentially. The measuring direction for the roughness measurement should be selected according to Table 2, based on the machining method and the resulting structures.

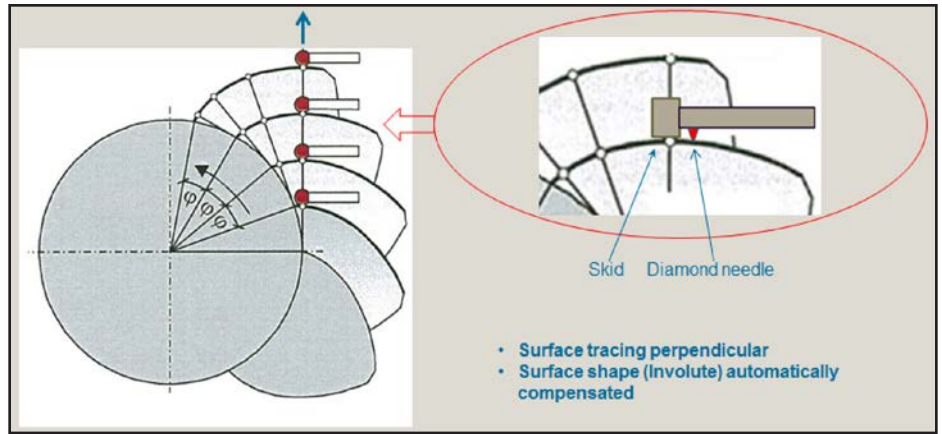


Figure 8 Skid probe system with involute reference (VDI/VDE 2612 Sheet 5).

Periodic profile <i>RSm</i> , mm	Non-periodic profile		Cut-off <sup>1)</sup> <i>λc</i> , mm	Sampling length ( <i>lr</i> )/ Evaluation length ( <i>ln</i> ) <sup>1)</sup> <i>lr/ln</i> , mm
	<i>Rz</i> , μm	<i>Ra</i> , μm		
> 0.013 to 0.04	> -0.025 to 0.1	> -0.006 to 0.02	0.08	0.08/0.40
> 0.04 to 0.13	> 0.1 to 0.5	> 0.02 to 0.1	0.25	0.25/1.25
> 0.13 to 0.4 <sup>2)</sup>	> 0.5 to 10 <sup>2)</sup>	> 0.1 to 2 <sup>2)</sup>	0.80 <sup>2)</sup>	0.8/4.0 <sup>2)</sup>
> 0.4 to 1.3	> 10 to 50	> 2 to 10	2.5	2.5/12.5
> 1.3 to 4.0	> 50 to 200	> 10 to 80	8.0	8.0/40

NOTES:  
 1) Sampling length, evaluation and cut-off according to DIN EN ISO 4288  
 2) Suitable parameters for grounded gears

Table 2 Selection of measuring direction based on machining method showing recommended tracing direction (based on process) (VDI/VDE 2612; Sheet 5)

	Grinding (Höfler)	Grinding (Reishauer)	Crosshatch (Maag 15°)
Tip			
Root			
Tip	Grinding (Maag 0°)	Grinding (form ground)	Hobbing, skiving
Tip			
Root			
Tip	Shaping, planning, broaching	Shaving	Honing
Tip			
Root			

NOTES:  
 Preferred tracing direction  
 Tracing direction for additional information (feed marks)

When selecting the appropriate parameters for the roughness measurement on tooth flanks, the stress on these surfaces due to compression and sliding must be taken into account. The parameter  $R_{max}$  has little meaning for this stress, as individually projecting peaks, which are of little relevance for the load capacity, are taken into account here. The arithmetic mean raw value  $R_a$  is greatly distributed, but correlates the least with the function parameters and therefore should not be used. The preferred parameter for roughness on flank surfaces is  $R_z$ , as it provides a high degree of clarity and makes it possible to draw accurate conclusions about the height of the roughness profile.

In addition to the parameters that describe only the vertical expansion of the roughness profile, it is important to determine the roughness structure in order to determine the wear behavior or

load capacity of a tooth flank. The stock percentage curve (Abbott-Firestone) and the resulting parameters  $R_k$ ,  $R_{pk}$  and  $R_{vk}$  are appropriate for determining the structure of the roughness profile. A nearly S-shaped pattern in the stock percentage curve is ideal. Another appropriate parameter for the stock percentage is  $R_{mr}$  (c). See Table 3 for a comparison of roughness parameters and stock percentage curves.



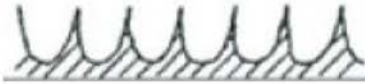



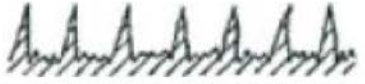
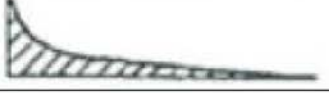








A standard roughness testing device (Ref. 3) is shown in Figure 9. In addition to a feed mechanism with a micro-probe system, the device also features a cross-slide to position and test the workpiece. An additional clamping fixture is generally needed to test toothed gears. According to the figure detail, compact reference area probe systems with an application range from module 0.5 can be used here. A PC computing system

with high-performance software is available to control and evaluate the roughness measurements. The evaluation software takes into account a large number of established roughness measurement standards. A report printout of the measuring results can be custom-designed.

One advantage of the device presented is that general workpieces can also be tested, and a higher standard overall is provided for roughness measurement. It does, however, require more set-up for flank measurements and the device is not suitable for large and heavy workpieces (500 mm in diameter, for example).

**Application example: cylindrical gear/bevel gear measurement on gear measuring centers.** Gear measuring centers are typically equipped with a rotary table for testing rotationally symmetrical workpieces and are suitable for measured value logging on small to very large

**Table 3 Evaluation of roughness profiles and associated stock percentage curves**

Roughness profile	$R_t$	$R_{max}$	$R_z$	$R_a$	$R_{mr}$ (0.25)	Abbott curve
	1	1	1	0.25	75%	
	1	1	1	0.25	15%	
	1	1	1	0.20	85%	
	1	1	1	0.20	20%	
	1	1	0.4	0.08	88%	
	1	1	0.4	0.08	7%	
	1	1	1	0.20	25%	
	1	1	1	0.30	38%	

**NOTES:**

- +  $R_a$
- ++  $R_z$
- +++  $R_k, R_{pk}, R_{vk}$



workpieces, in conjunction with a model series. As previously described, the measuring method used here is the involute reference method in combination with a skid system.

For roughness measurement a special probe system on the adapter plate of the measuring machine's macro probe system is adapted (Fig. 10). An additional electrical connection is provided for transferring the measured values from the integrated micro-probe system for the roughness measurement. For measured value logging in the profile direction, the probe skid rests on the flank to be tested and executes a movement similar to a normal profile measurement for the macrostructure of the flank. As it does so, a diamond needle located in front of the probe skid logs the measured values for the roughness measurement. The probe system represented here is also suitable for measured value logging in the tooth trace direction. The roughness probe system also features an adjustment mechanism enabling the probe needle to be aligned perpendicular to the surface for helical cylindrical gears as well.

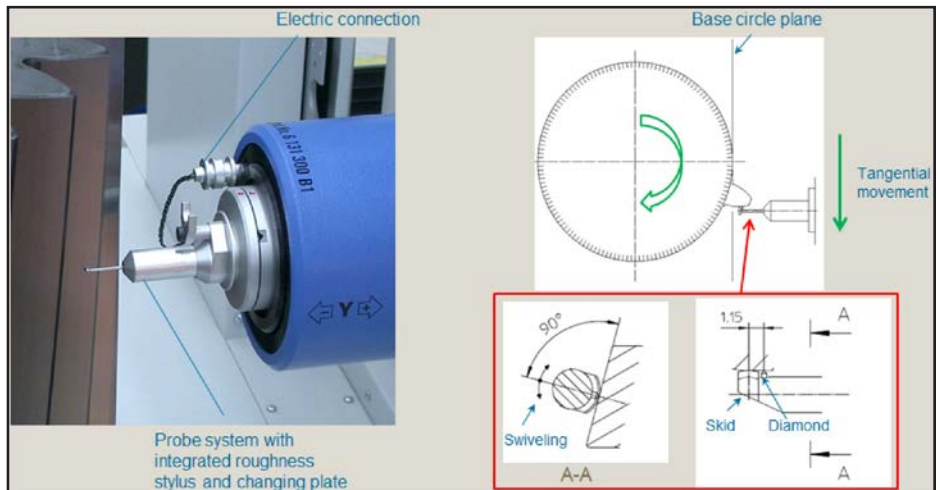
Thus in conjunction with an automatic probe change rack, a fully automatic process can be carried out for the roughness measurement in combination with other gear measurements. Because the measured value logging is controlled by the CNC-guided measuring axes, this results in highly precise positional accuracy and reproducibility for the measuring positions. The most important technical data for the integrated roughness test equipment are shown in Table 4.

To document the measuring results, the roughness parameters can also be documented on the standard measuring sheet for profile and reference tooth traces, or they can be printed as a separate measuring sheet including diagrams (Fig. 11).

Comparable to measured value logging on cylindrical gears, roughness measurements can also be conducted on bevel gears. The profile measurement here takes place based on the calculated nominal data, which are available in high resolution for measuring the macrostructure. Various probe systems are used for measured value logging, depending on



**Figure 9** Standard roughness test device — example stationary surface measuring station for gears (Mahr catalog).



**Figure 10** Roughness testing device (cylindrical gear) on gear measuring centers — roughness inspection in profile direction (involute reference).

Table 4 Technical data for roughness probe systems			
Length	$L_t$ (mm)	1.5	4.8
Cut-off filter	$\lambda_c$ (mm)	0.25	0.8
Technical data:			
Device class to DIN EN ISO 3274 (DIN 4772), Class 1			
Output values to DIN EN ISO 4287 (DIN 4762), $R_a$ , $R_z$ (DIN), $R_t$ , $R_{max}$			
Resolution: $R_a$ 0.01 $\mu\text{m}$ (< 0.1 $\mu\text{m}$ : 0.001 mm), all other parameters: 0.1 $\mu\text{m}$			
Cut-off filter $\lambda_c$ to DIN EN ISO 11562: phase correct digital Gaussian filter (M1)			
Sampling length $L_t$ /Cut-off filter $\lambda_c$ (fixed correlation)			
Micro-roughness filter $\lambda_c$ : 2.5 $\mu\text{m}$			
Evaluation of single measured lengths			
Skid radius: lengthwise 10 mm, crosswise 1.0 mm			
Feed rate $v_t$ : 0.5 mm/sec			
Static probe force on the sliding skid: < 200 Nm (< 20 g)			
Static measuring force on the probe tip: < 0.5 Nm			
Probe tip: diamond, conical form			
Probe tip radius: 5 $\mu\text{m}$			
Probe tip angle 90°			
Offset between probe tip and sliding skid: lengthwise 1 mm, crosswise 0 mm			
Maximum measuring stroke of probe tip: $\pm 100$ mm			

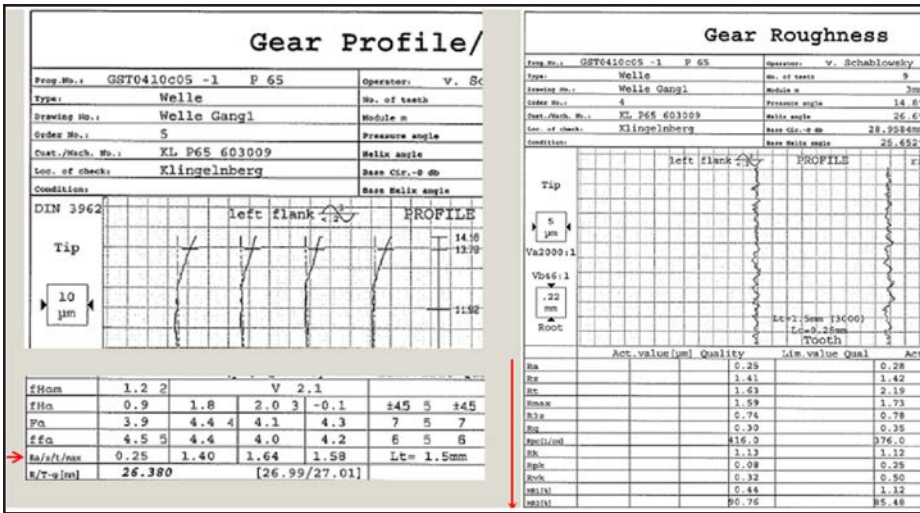


Figure 11 Results output: roughness measurement on gear measuring centers.

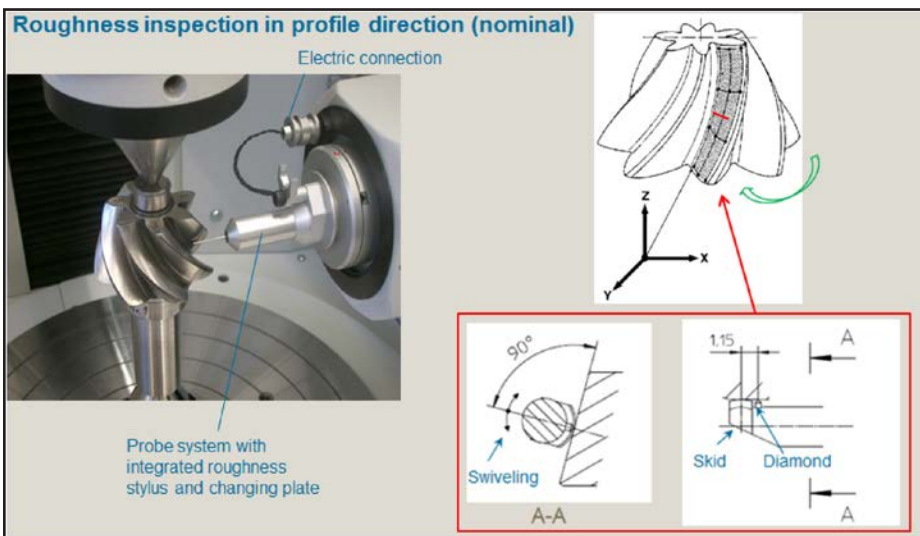


Figure 12 Roughness testing device (bevel gear) on gear measuring centers.

the design of the bevel gears pinions/ ring gears. For pinion shafts a straight probe system is used — exactly like the probe system for cylindrical gears (Fig. 12) — and an angled system is used for ring gears.

A fully automatic test sequence can also be specified via the software operator guidance. Measuring positions, measuring paths, and the number of flanks to be tested, etc., can be programmed individually (Fig. 13). The measuring results are displayed numerically on the screen for the selected flanks (Fig. 14); measured values can also be printed out with diagrams (Fig. 15).

Thus the device presented here offers a reliable, convenient measuring method for roughness measurement on spiral bevel gears with spatially pronounced curves. Large-module bevel gears can also be tested in conjunction with suitable probe systems.

### Concluding Remarks

These important measured values can be carried out quickly and easily in conjunction with conducting roughness measurements of tooth flanks on gear measuring centers using the equipment presented here.

Measurements on both smaller and larger gear teeth can be taken in a single

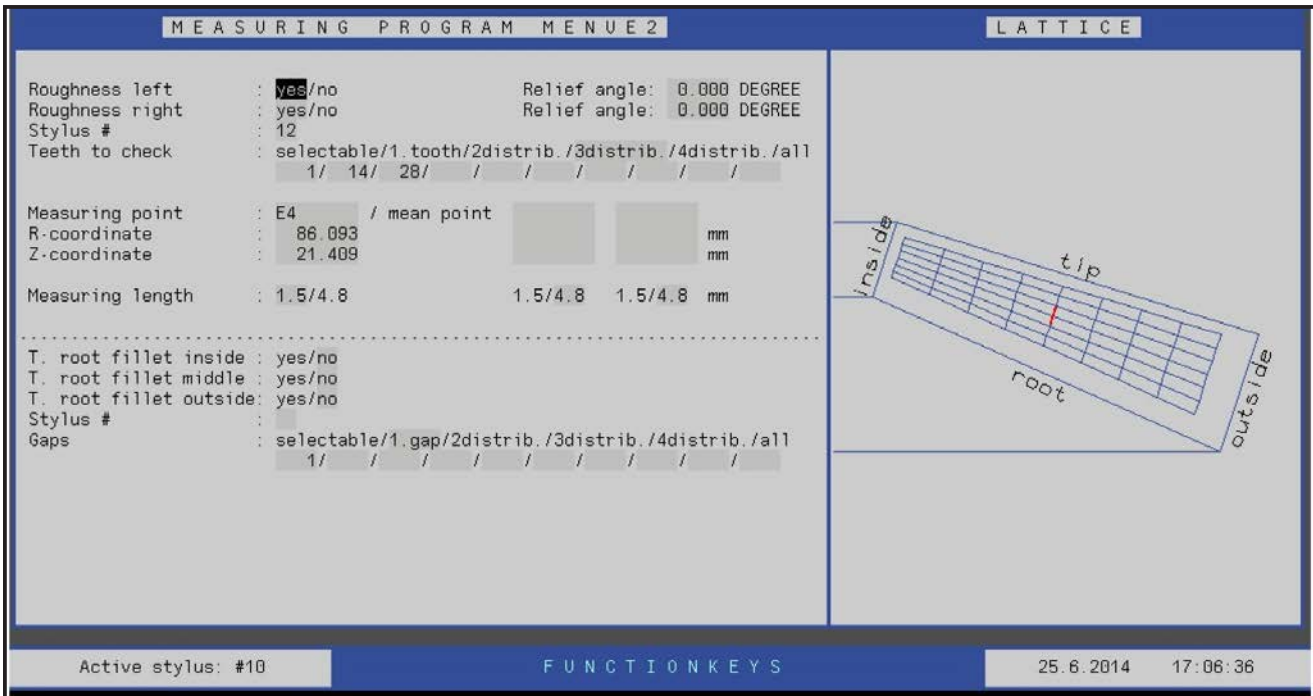


Figure 13 Operator guidance: roughness measurement on gear measuring centers.



Measuring position: E4; R: 86.093; Z: 21.409 mm  
Length of traceline (Lt): 1.500 mm Cutoff filter (Lc): 0.250 mm

Tooth	Flank	Ra μm	Rz(DIN) μm	Rt μm	Rmax μm	R3z μm	Rq μm	Rpc 1/cm	Rk μm	Rpk μm	Rvk μm	MR1 %	MR2 %	R μm	AR μm
1	concave	0.96	6.01	8.42	7.29	1.98	1.27	240.00	3.62	0.69	2.45	0.44	83.3	0.00	0.00
1	convex	0.66	3.66	4.81	4.44	0.98	0.84	232.00	2.61	0.37	1.33	0.40	83.9	0.00	0.00
14	concave	1.04	6.07	8.23	7.15	2.32	1.33	232.00	3.89	0.56	2.50	0.20	83.1	0.00	0.00
14	convex	0.52	3.17	4.77	4.00	1.11	0.66	208.00	2.28	0.58	1.03	0.36	89.7	0.00	0.00
28	concave	0.87	5.68	7.38	7.25	2.09	1.12	352.00	3.44	0.39	1.89	0.64	85.3	0.00	0.00
28	convex	0.70	4.10	6.24	5.91	0.00	0.93	176.00	2.36	0.34	2.15	0.72	82.9	0.00	0.00
Mean	concave	0.96	5.92	8.01	7.23	2.13	1.24	274.67	3.65	0.55	2.28	0.43	83.9	0.00	0.00
Mean	convex	0.63	3.64	5.27	4.78	0.70	0.81	205.33	2.42	0.43	1.50	0.49	85.5	0.00	0.00
Mean	cv.+cx.	0.79	4.78	6.64	6.01	1.41	1.02	240.00	3.03	0.49	1.89	0.46	84.7	0.00	0.00

Figure 14 Results output: roughness measurement on gear measuring centers.

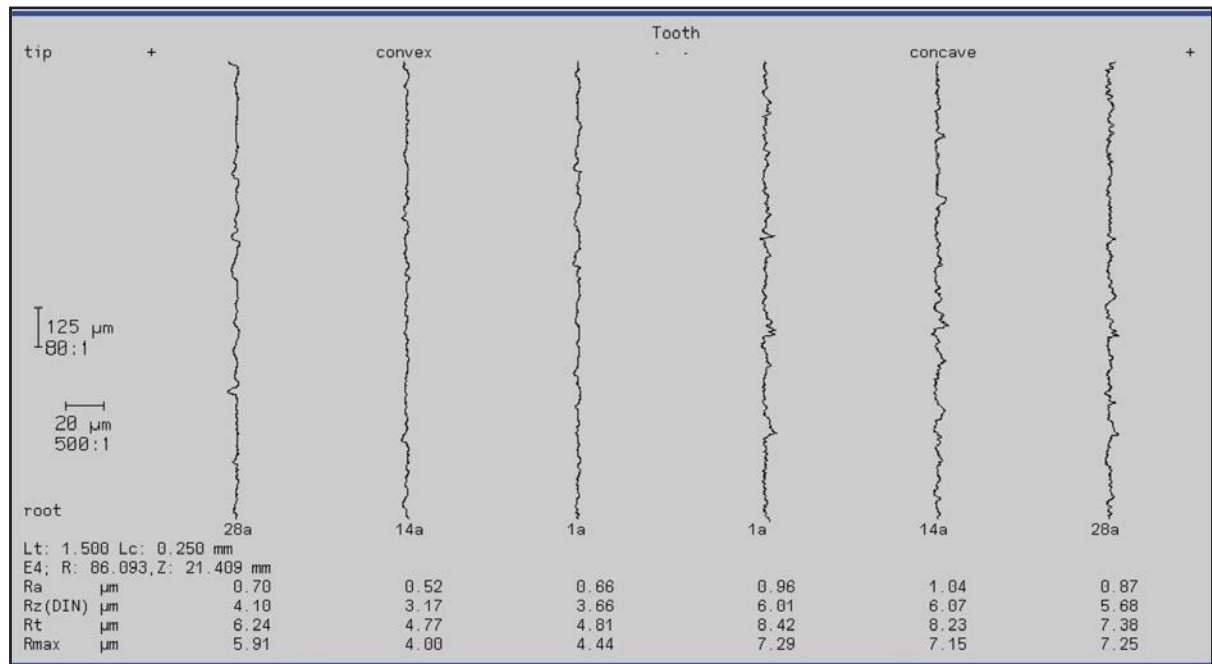


Figure 15 Roughness bevel diagram.

clamping in conjunction with standard test parameters.

The measurement conditions for standardized roughness measurements are largely met by measured value logging in the profile direction with CNC-controlled contouring in generation mode for each tooth profile. ⚙️

## References

1. VDI/VDE 2612; Sheet 5. *Measurement and Testing of Gearing: Surface Roughness Measurement of Cylindrical Gears and Bevel Gears by Means of Stylus-Type Instruments* (Release 2014/2015).
2. Jenoptik publication.
3. Mahr publication. "Mar Surf XR 20 Roughness Testing Device."

**Dipl.-Ing. Guenter Mikoleizig** currently heads the product management and application engineering department for gear inspection machines at Klingelberg GmbH, Germany. With more than 30 years in the field of gear inspection technology, he is fully experienced with the design and development of inspection machines and their product management. He in fact developed a product line of inspection machines for an array of gears and related parts, with small dimensions up to the very large-sized. Mikoleizig has presented papers about gear inspection worldwide and is also an active member of national and international standardization committees.



# Hypoid Gears with Involute Teeth

David B. Dooner

This paper presents the geometric design of hypoid gears with involute gear teeth. An overview of face cutting techniques prevalent in hypoid gear fabrication is presented. Next, the specification of a planar involute rack is reviewed. This rack is used to define a variable diameter cutter based upon a system of cylindroidal coordinates; thus, a cursory presentation of cylindroidal coordinates is included. A mapping transforms the planar involute rack into a variable diameter cutter using the cylindroidal coordinates. Hypoid gears are based on the envelope of this cutter. A hypoid gear set is presented based on an automotive rear axle.

## Background

Cylindrical gearing is the simplest of all gear types and is used more than any other. Bevel and hypoid gear manufacturing analysis entail spatial, geometric relations, whereas spur and helical gear manufacturing analysis entail mostly planar geometric relations. Existing methods of manufacture for different gear forms are type-specific and generally unrelated. For example, the machines used to produce hypoid gears cannot be readily used or for fabricating spur cylindrical gears. The methods of manufacture associated with bevel and hypoid gears do not allow these gears to be treated with the same type of geometric considerations that currently exist for cylindrical gears. To illustrate, spur cylindrical gears are helical gears with a zero helix angle; both gear types can be produced using the same machine. But spur hyperboloidal gears cannot be readily produced using existing fabrication techniques for spiral hyperboloidal gears. The majority of hypoid and bevel gear manufacture today is the focus of The Gleason Corporation and Klingelnberg-Oerlikon. The following three companies provide the machines and machine tools necessary for the production of hypoid gears:

- The Gleason Works ([www.gleason.com](http://www.gleason.com))
- Klingelnberg-Oerlikon ([www.klingelnberg.com](http://www.klingelnberg.com))
- Yutaka Seimitsu Kogyo LTD ([http://www.yutaka.co.jp/Y\\_hp6/default2.htm](http://www.yutaka.co.jp/Y_hp6/default2.htm))

Depicted in Figure 1 are circular face cutters used today for fabricating spiral bevel and hypoid gear elements. Certain limitations of existing crossed-axis gear technology can be realized by focusing on Figure 2. The theoretical or ideal shape of these crossed-axis gears is the “hour-glass” — or hyperboloidal — shape shown. Current design and manufacturing techniques approximate a portion of the hour-glass shape by a conical segment, as shown. This approximation results in the following restrictions:

- Face width
- Minimum number of teeth
- Spiral angle
- Pressure angle

These restrictions in turn limit candidate gear designs. Face cutting further places restrictions on the above limitations,

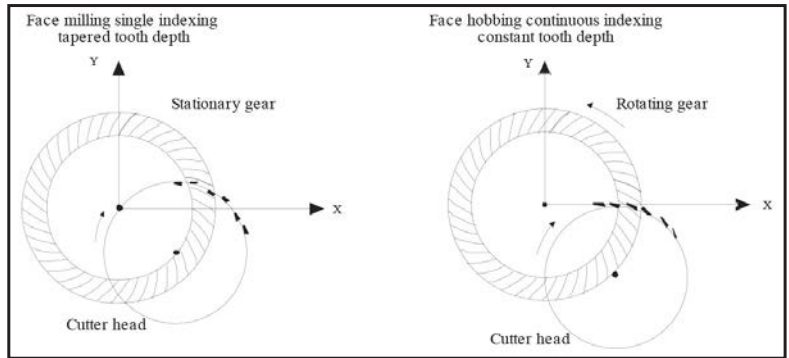


Figure 1 Face cutting.

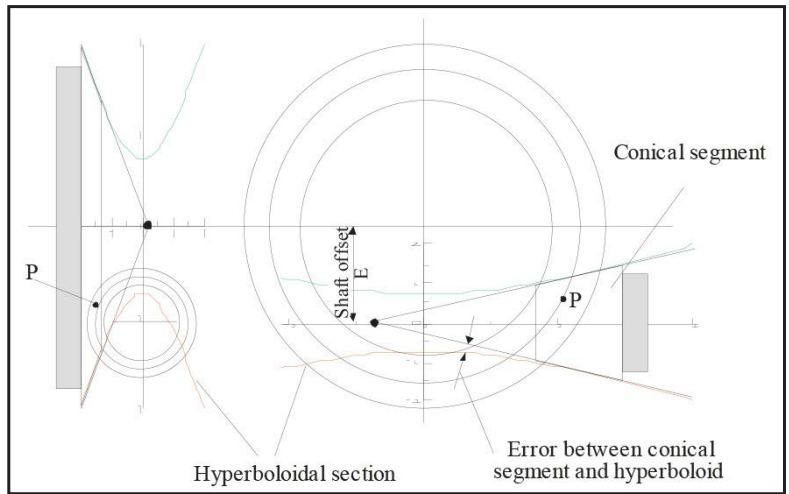


Figure 2 Conical segments for hypoid gears.

together with the gear ratio. An overview of face cutting methods for hypoid gear design and manufacture is provided by Shtipelman (Ref. 1); Stadtfeld (Ref. 2); Wu and Lou (Ref. 3); Wang and Ghosh (Ref. 4); and Litvin and Fuentes (Ref. 5). Radzevich (Ref. 6) and Kapelevich (Ref. 7) provide updated approaches for gear design and manufacture. Preliminary investigations into the “ideal” kinematic geometry of spatial gearing have been recognized by Xiao and Yang (Ref. 8); Figliolini et al. (Ref. 9); Hestenes (Ref. 10); and Ito and Takahashi (Ref. 11). Grill (Ref. 12) uses an “equation of meshing” to establish a relation between the curvature of one body to that of another body and applies his results in the context of gearing. Baozhen et al use Lie Algebra for a coordinate-free approach akin to screw



theory (Ref. 13). Phillips (Ref. 14) proposes a qualitative approach for point contact of hypoid “involute” teeth. A hyperboloidal cutter was proposed as part of a unified methodology for the analysis, synthesis, and manufacture of generalized gear pairs (Ref. 15).

The manufacture of generalized gear elements is proposed by introducing a hyperboloidal or variable diameter cutter to mesh with a desired gear. An illustration of a hyperboloidal hob cutter and hypoid gear/work piece is depicted in Figure 3. The desired gear depends upon the cutter geometry along with its position and orientation relative to the gear. Two toothed bodies in mesh where the sum  $\psi_{pi} + \psi_{po}$  of the spiral angles is non-zero is established to determine the cutter’s position and orientation relative to the gear element.

The most common occurrence where  $\psi_{pi} + \psi_{pc} \neq 0$  is for crossed cylindrical gears. The included angles  $\alpha_{pi}$  and  $\alpha_{pc}$  for cylindrical toothed bodies are zero, and the angle between the two axes  $S_i$  and  $S_c$  reduces to  $\psi_{pi} + \psi_{pc} = \Sigma$ . Meshing conditions where  $\psi_{pi} + \psi_{pc} \neq 0$  and  $\alpha_{pi} + \alpha_{pc} \neq 0$  are defined as *crossed hyperboloidal gears*. The I/O relationship for the meshing or generating cylindroid between two crossed hyperboloidal gears in mesh is identified by an “s” subscript and is uniquely defined as the *swivel I/O relationship*  $g_s$ . Generating conditions are determined using  $g_s$ , the *swivel center distance*  $E_s$ , and the *swivel shaft angle*  $\Sigma_s$ .

### Rack Coordinates

Introducing the rack as an intermediate step for defining a candidate cutter is based on its simplicity and usefulness in transforming rotary motion into linear motion. Rack coordinates used to parameterize a gear tooth repeat each pitch  $P_d$ , thus, it is necessary to parameterize candidate rack tooth profiles for one pitch. The “r” subscript is used to designate that the indicated variable is in regards to the rack. If the teeth are symmetric about a line through the center of the tooth, then candidate tooth profiles need to be specified only for one-half of the pitch  $P_d$ . The Cartesian coordinates  $(x_r, y_r)$  for the rack shown in Figure 4 are divided into three regions — 1) crest; 2) active region; and 3) fillet.

This is achieved by specifying the coordinates  $(x_r, y_r)$  for the active region according to a particular application. For example, if zero errors in the I/O relationship  $g$  must be achieved for small changes in center distance  $E$ , then, as anticipated, the active profile becomes a straight line. Subsequently, the crest is determined by the “optimal” fillet of the generated gear blank. This occurs because the crest of the cutter determines the fillet of the generated blank. The fillet of the cutter is determined such that the crest of one gear pair does not interfere with the fillet of the mating gear.

The diametral pitch  $P_d$  is defined as the number of teeth per inch of pitch diameter for spur circular gears. For two toothed wheels in mesh, this leads to:

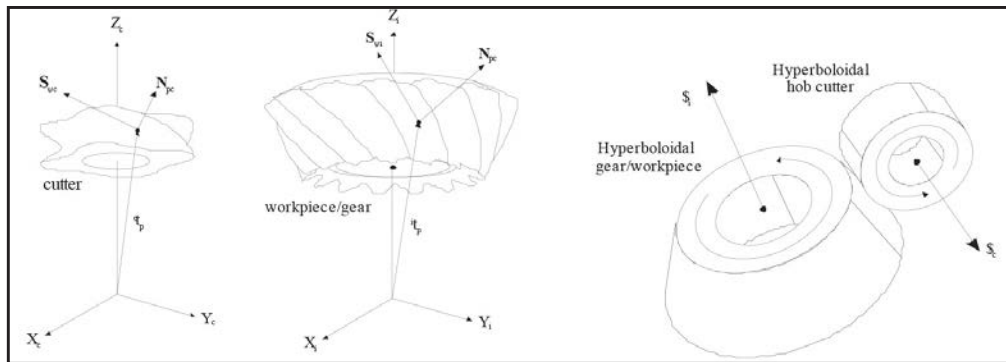


Figure 3 Cutter and gear elements.

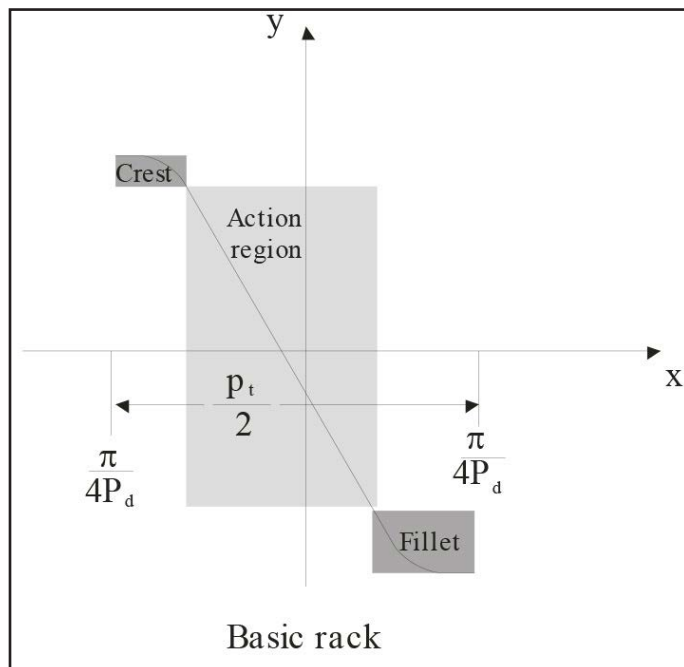


Figure 4 The rack.

(1)

$$P_d = \frac{N_i}{2u_{pi}} = \frac{N_o}{2u_{po}}$$

Where

$N_i$  = Number of teeth on the input

$u_{pi}$  = Pitch radius of the input

$N_o$  = Number of teeth on the output

$u_{po}$  = Pitch radius of the output

Recognizing that  $u_{pi} + u_{po} = E$ , where  $E$  is the distance between the two axes of rotation, the diametral pitch  $P_d$  is expressed:

(2)

$$P_d = \frac{N_i + N_o}{2E}$$

The module  $m_d$  is used in the metric system, where:

(3)

$$m_d = \frac{d_i}{N_i} = \frac{1}{P_d}$$

Such an expression for the tooth size is ingenious and is used to specify the addendum and dedendum height. The distance  $p_n$  between adjacent teeth can also be expressed in terms of diametral pitch  $P_d$ . Two gears in mesh must have the same  $p_n$  or normal pitch. In turn, this normal pitch can be resolved into a transverse pitch  $p_t$  and an axial pitch  $p_a$ . At this point it is con-

venient to temporarily abandon this terminology and introduce the distance between adjacent teeth as the *circular pitch*  $c_p$ , with no indication as to whether it is the transverse, axial, or normal pitch.

A mapping is used to transform the rack coordinates  $(x, y)$  to polar gear tooth coordinates  $(u, v)$ . This transformation can be envisioned as wrapping a rack onto a pitch circle with the desired pitch radius  $u_p$ . This transformation is the envelope of the rack as it meshes with a circle of radius  $u_p$ . Depicted in Figure 5 is a rack being wrapped onto a pitch circle with radius  $u_p$ .

### Cylindroidal Coordinates

A system of curvilinear coordinates is used to parameterize the kinematic geometry of motion transmission between skew axes. These curvilinear coordinates are based upon the cylindroid determined by the two axes of rotation,  $\$_i$  and  $\$_o$ , and are referred to as cylindroidal coordinates. Cylindroidal coordinates consist of families of pitch, transverse, and axial surfaces. Pitch surfaces are specified in terms of the axes of rotation  $\$_i$  and  $\$_o$ .  $\$_i$  is the input axis (pinion) of rotation and  $\$_o$  is the output (ring) axis of rotation. Pitch surfaces are a family of ruled surfaces, and axodes are the unique pitch surfaces that depend upon a par-

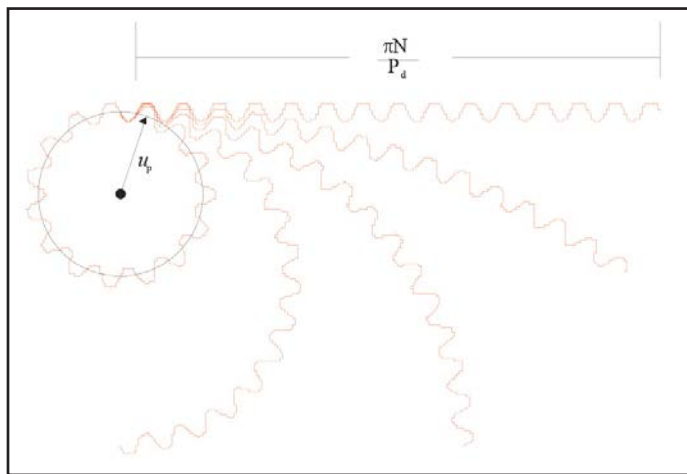


Figure 5 Transforming or “wrapping” the rack onto the desired pitch circle.

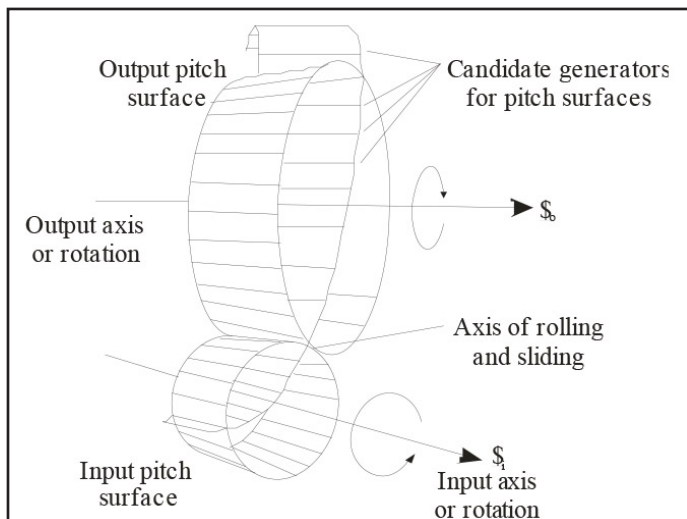


Figure 6 Two friction wheels for motion transmission between skew axes.

ticular I/O relationship. For this reason, the pitch surfaces are referred to as the reference pitch surfaces.

A system of curvilinear coordinates  $(u, v, w)$  is used to describe spiral bevel and hypoid gears. The coordinates  $(u, v, w)$  used to parameterize these families of pitch, transverse, and axial surfaces are formulated using the cylindroid defined by the input and output axes of rotation. A design methodology for spatial gearing analogous to cylindrical gearing begins with the equivalence of friction cylinders. Figure 6 shows two such wheels along with candidate generators. The I/O relationship  $g$  defines which generator of the cylindroid is used to parameterize the input and output friction wheels. These generalized friction surfaces are two ruled surfaces determined by the instantaneous generator. The transmission of motion between the two generally disposed axes  $\$_i$  and  $\$_o$  via two friction surfaces requires knowledge of the instantaneous generator. The location of the instantaneous generator relative to the two axes  $\$_i$  and  $\$_o$  depends upon:

- Distance  $E$  along the common perpendicular to axes of rotation  $\$_i$  and  $\$_o$
- Angle  $\Sigma$  between axes of rotation  $\$_i$  and  $\$_o$
- Magnitude of the I/O relationship  $g$

Motion transmission between the two skew axes  $\$_i$  and  $\$_o$  results in a combination of an angular displacement about the instantaneous generator and a linear displacement along the instantaneous generator. The ratio  $h$  of linear displacement to that of the angular displacement is the *pitch* associated with the instantaneous generator. The pitch  $h_{isa}$  associated with the instantaneous generator is the *instantaneous screw axis*, or ISA.

A transverse surface is an infinitesimally thin surface used to parameterize conjugate surfaces for direct contact between two axes. Candidate generators for the reference pitch surface are determined by the generators of the cylindroid  $(\$_i, \$_o)$ . Given  $g$ , each position angular  $v_i$  and axial position  $w_i$  define a unique point  $p$  in space. Allowing  $g$  to vary from  $-\infty$  to  $\infty$ , the point  $p$  traces a curve in space. Another value of the input position  $v_i$  defines the same cylindroid. There is an angular displacement between these two cylindroids. It is this two-parameter loci of points  $p$  that compose the transverse surface. The Cartesian coordinates  $r$  for the single point  $p$  on the generator  $\$_{ai}$  are:

$$r = u_i \hat{i} + w_i \sin \alpha_i \hat{j} + w_i \cos \alpha_i \hat{k} \tag{4}$$

Rotating the above curve  $r$  about the  $z_i$ -axis an amount  $v_i$  leads to:

$$r = \begin{bmatrix} \cos v_i & \sin v_i & 0 \\ -\sin v_i & \cos v_i & 0 \\ 0 & 0 & 1 \end{bmatrix} \begin{bmatrix} u_i \\ -w_i \sin \alpha_i \\ w_i \cos \alpha_i \end{bmatrix} \tag{5}$$

Where

- $u$  radius of hyperboloidal pitch surface (at throat)
- $v$  angular position of generator on pitch surface
- $w$  axial position along generator of pitch surface
- $\alpha$  angle between generator and central axis of pitch surface

The *axial surface* provides the relationship between successive transverse surfaces. For each value of  $v_i$ , the axial surface is the loci of generators determined by  $g$ , where  $-\infty < g < \infty$ . The curves defined by holding two of the three parameters  $u, v$ , and  $w$  constant are coordinate curves. Two parameters used to define



a surface are the curvilinear coordinates of that surface: the pitch surface by  $v_i$  and  $w_i$  ( $u_i = \text{constant}$ ), the transverse surface by  $u_i$  and  $v_i$  ( $w_i = \text{constant}$ ), and the axial surface by  $u_i$  and  $w_i$  ( $v_i = \text{constant}$ ). Depicted in Figure 7 are the pitch, transverse, and axial surfaces determined using cylindrical coordinates  $(u_i, v_i, w_i)$ . Three surfaces are used to describe the geometry of gear elements.

The curvilinear coordinates  $(u_c, v_c, w_c)$  used to parameterize the proposed cutters are defined by introducing a cutter-cylindroid  $(\mathcal{S}_c; \mathcal{S}_{co})$ . This enables cutters to be designed in pairs analogous to the design of gear pairs where two cutters are proposed for the fabrication of spiral toothed bodies. One feature of the cutter cylindroid is that expressions involving the cutters are obtained by simply changing the trailing subscripts in existing expressions involving the input gear from “ $i$ ” to “ $c$ ”. In order to minimize the notation necessary to distinguish the input cutter from the output cutter, only a “ $c$ ” subscript is used with no indication as to whether it is the input cutter or the output cutter.

Implicit in the cutter designation will be an “ $o$ ” subscript when describing the input gear. Likewise, when describing the output gear body, it will be assumed that associated with the cutter is an “ $i$ ” subscript to identify that it designates the input cutter. The above reasoning is that two toothed bodies in mesh involve an input and an output body. The three possibilities being:

- Input gear body and an output gear body
- Input gear body and an output cutter
- Input cutter and an output gear body

The two twist axes  $\mathcal{S}_{ci}$  and  $\mathcal{S}_{co}$  are the two screws of zero pitch on the cutter cylindroid  $(\mathcal{S}_c; \mathcal{S}_{co})$ . The generators  $\mathcal{S}_{pc}$  are determined by also introducing a cutter I/O relationship  $g_c$ . Expressions for the radius  $u_{ac}$  and the angle  $\alpha_{ac}$  are identical to those for  $u_{ai}$  and  $\alpha_{ai}$ , except  $E, \Sigma,$  and  $g$  are replaced by  $E_c, \Sigma_c,$  and  $g_c$  respectively.

### Hyperboloidal Cutter Coordinates

General hyperboloidal cutter elements are defined by introducing a mapping within a system of cylindrical coordinates. The purpose of this mapping is to utilize knowledge of conjugate curves for motion transmission between parallel axes and apply it to conjugate surfaces for motion transmission between skew axes. A visual representation of this mapping is shown in Figure 8. There exists a single generator within a system of curvilinear coordinates as part of the cylindroid  $(\mathcal{S}_c; \mathcal{S}_{co})$  that is coincident with each point  $(u, v)$ . For an arbitrary axial position  $w_c$  along this generator, a transverse surface exists. Each value  $(u, v)$  defines a different generator. The distance  $w_c$  along each of these generators from  $(u, v)$  to a single transverse surface is constant. It is the image of these datum points  $(u, v)$  upon a given transverse surface that defines the mapping. This mapping is valid for

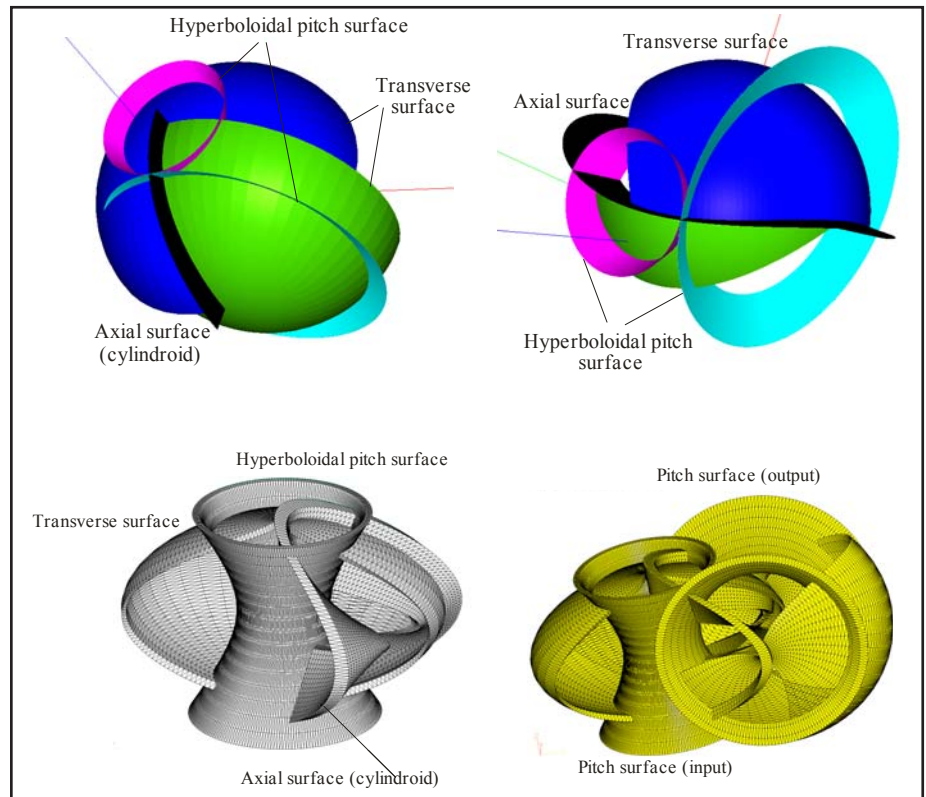


Figure 7 Pitch, transverse, and axial surface for uniform motion transmission.

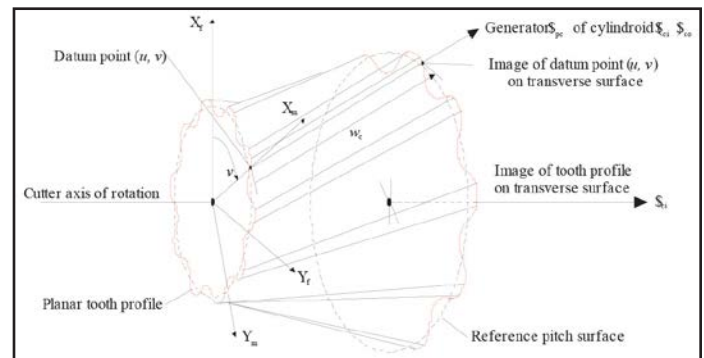


Figure 8 Mapping of planar gear profile onto transverse surface.



any type of cutter tooth profile (viz., involute, cycloidal, circular-arc, and convuloid).

The planar coordinates  $(u, v)$  used to define conjugate curves are polar coordinates where  $v$  is an angular position about the “z-axis” and  $u$  is the corresponding radius. Use of coordinates  $(u, v)$  to specify conjugate curves in the plane are fashioned such that conjugate surfaces in space are obtained using the cylindrical coordinates  $(u_c, v_c, w_c)$ . This is achieved by assigning a value to the axial position  $w_c$  and defining  $u_c \equiv u$  and  $v_c \equiv v$ . Cutter coordinates must be “scaled” to satisfy the appropriate transverse pitches. Such scaling is illustrated in Figure 9 and is obtained by recognizing that the virtual length of the striction curve  $s_{pc}$  is the component of its length perpendicular to the tooth. This scaling is performed prior to the “wrapping” of the rack onto the circular disk depicted in Figure 3 and depends on the diametral pitch. The diametral pitch  $P_d$  used to parameterize the cutter teeth depends on the size or radius of the input and output cutter. The x-scaling or stretch along the x-axis is shown in Figure 9 and depends on the cone angle  $\alpha_{pc}$ ; thus, for an arbitrary angle  $v_c$ , the corresponding parameter  $x_r$  used to evaluate the expressions for the tooth profile becomes:

$$x_c = \chi_x u_{pc} v_c \tag{6}$$

Where

$$\chi_x = \cos \alpha_{pc} \cos \gamma_{pc}$$

The angle  $\alpha_{pc} = \gamma_{pc}$  at the throat (i.e.,  $w_c = 0$ ). It is the diametral pitch at the throat that is used to specify the pitch of the cutter profiles. The cutter is expressed using the Cartesian coordinates  $(x_c, y_c, z_c)$  as follows:

$$\begin{bmatrix} x_c \\ y_c \\ z_c \end{bmatrix} = \begin{bmatrix} \cos v_c & \sin v_c & 0 \\ -\sin v_c & \cos v_c & 0 \\ 0 & 0 & 1 \end{bmatrix} \begin{bmatrix} u_c \\ -w_c \sin v_c \\ w_c \cos v_c \end{bmatrix} \tag{7}$$

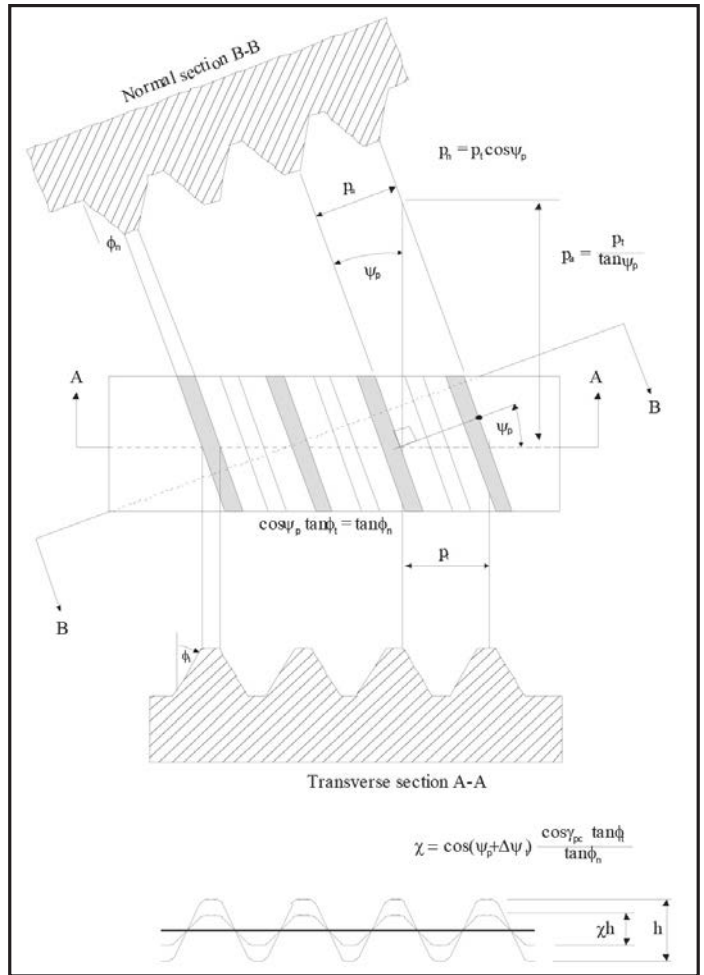
The image of the coordinates  $(x_c, y_c, z_c)$  upon the transverse surfaces must account for the cutter spiral. Consequently, a transverse angular displacement  $\Delta v_{wc}$  is superimposed on the mapping as follows:

$$T_c = \begin{bmatrix} \cos \Delta v_{wc} & \sin \Delta v_{wc} & 0 \\ -\sin \Delta v_{wc} & \cos \Delta v_{wc} & 0 \\ 0 & 0 & 1 \end{bmatrix} \begin{bmatrix} x_c \\ y_c \\ z_c \end{bmatrix} \tag{8}$$

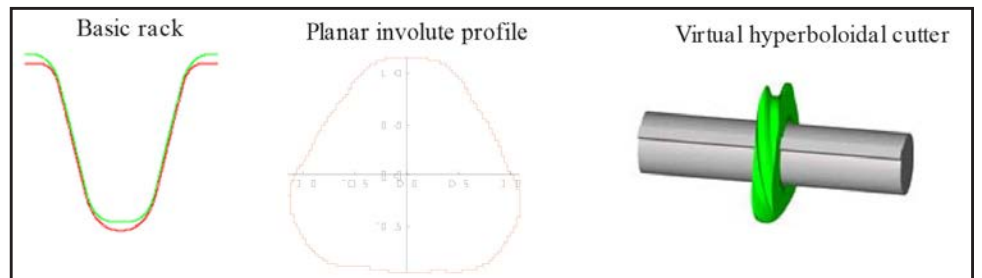
The cutter spiral depends on the ratio between the axial displacement  $\Delta w_{wc}$  and the angular displacement  $\Delta v_{wc}$ . The displacement  $\Delta v_{wc}$  is based on a constant lead for a given transverse surface and the spiral angles  $\psi_c$  for each radii  $u_c$  are different. Note that the displacement  $\Delta v_{wc}$  is based on the lead for the reference pitch surface and the spiral angles  $\psi_c$  change for each radius  $u_c$ .

**Illustrative Example**

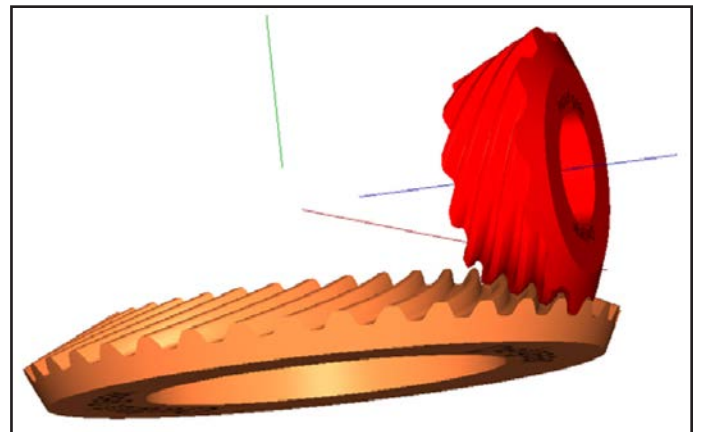
This example presents a spiral hypoid gear set for motion transmission between skew axes using *Delgear* software (Ref. 16). The shaft angle is  $90^\circ$  and the shaft offset is 25 mm. The speed ratio 3.27; 11 teeth on the pinion and 36 teeth on the ring gear. The face width is 35 mm, the axial contact ratio is 3.0 and the nominal spiral angle is  $61^\circ$ . The tooth profile is a standard invo-



**Figure 9** Scaling of tooth profile on cutter element.



**Figure 10** Rack, transverse profile, hyperboloidal cutter.




**Figure 11** Input and output gears with involute teeth.



lute tooth profile. The normal pressure angle is  $20^\circ$ , the transverse contact ratio is 1.25, the addendum constant is 1.0 and the dedendum constant is 1.2. The variable diameter cutter has three teeth and the nominal lead angle is  $10^\circ$ . Figure 10 shows the rack tooth, a transverse segment of the cutter, and a virtual model of the cutter. The gear pair is depicted in mesh in Figure 11.

## Summary

Demonstrated is the specification of involute gear teeth on hypoid gears. This process involves the specification of a classical involute rack, a mapping that transforms this rack to a planar circular profile. A system of cylindrical coordinates is used to define hyperboloidal cutters. Another transformation is used to map the planar circular profile to a hyperboloidal cutter with suitable geometry for specifying general spiral bevel and hypoid gear pairs. An example of an automotive rear differential gear set is presented to illustrate the process. 

## References

1. Shtipelman, B.A. *Design and manufacture of Hypoid Gears*, 1978, John Wiley & Sons, New York.
2. Stadtfeld, H.J. *Handbook of Bevel and Hypoid Gears*, 1993, Rochester Institute of Technology, Rochester.
3. Litvin, F.L. and A. Fuentes. *Gear Geometry and Applied Theory*, 2004, 2nd Ed. Cambridge University Press, London England.
4. Wu, D. and J. Luo. *A Geometric Theory of Conjugate Tooth Surfaces*, 1992, World Scientific, New Jersey.
5. Wang, K.L. and S.K. Ghosh. *Advanced Theories of Hypoid Gears*, 1994, Elsevier, Amsterdam.
6. Radzevich, S. P. *Theory of Gearing: Kinematics, Geometry, and Synthesis*, 2012, CRC Press, Taylor and Francis Group.
7. Kapelevich, A.L. *Direct Gear Design*, 2013, CRC Press, Taylor and Francis Group.
8. Xiao, D.Z. and A.T. Yang. "Kinematics of Three-Dimensional Gearing," 1989, *Mechanism and Machine Theory*, Vol. 24, Issue 4, pp. 245-255.
9. Figliolini, G., H. Stachel and J. Angeles. "The Computational Fundamentals of Spatial Cycloidal Gearing," 2009 *Proceedings of 5th International Workshop on Computational Kinematics*, Dusseldorf Germany, May, pp. 375-384, Springer.
10. Hestenes, D. "Old Wine in New Bottles: a New Algebraic Framework for Computational Geometry," 2001, *Geometric Algebra with Applications in Science and Engineering*, E. Bayro-Corrochano and G. Sobczyk, Eds. pp. 1-16, Birkhauser, Boston, MA.
11. Ito, N. and K. Takahashi. "Extension of the Euler-Savary Equation to Hypoid Gears," 1999, *MSME Mechanical Systems, Machine Elements, and Manufacturing*, Series C, Vol. 42, No. 1.
12. Grill, J. "Calculating and Optimizing of Grinding Wheels for Manufacturing Grounded Gear Hobs," 1999, *4th World Congress on Gearing and Power Transmission*, Paris France, Mar. 16-18, pp. 1661-1671.
13. Baozhen, L., H. Lowe and W. Xumwei. "A New Approach to the Theory of Gearing Using Modern Differential Geometry," 2013, *International Conference on Gears*, Munich Germany, Oct. 7-9, pp. 1379-1390.
14. Phillips, J.R. *Geared Spatial Involute Gearing*, 2003, Springer, Berlin.
15. Dooner, D.B. *Kinematic Geometry of Gearing*, 2012, 2nd Ed., Wiley, London.
16. <http://www.delgear.com>.

# Get the Royal Treatment



Stop being a servant to the search bar—[www.geartechnology.com](http://www.geartechnology.com) is a website fit for a king or queen:

- Complete archive of articles on gears and gear components
- Directory of suppliers of gears
- Product and Industry News updated daily
- Exclusive online content in our e-mail newsletters
- The Gear Technology Blog
- Calendar of upcoming events
- Comprehensive search feature helps you find what you're looking for

# gear

TECHNOLOGY

**David Dooner** graduated from the University of Florida in 1991. Afterwards, he was a visiting scientist with the Russian Academy of Sciences in Moscow and joined the University of Puerto Rico-Mayaguez (UPRM) in 1994. Since joining UPRM, he has been involved with teaching, services, and research. His research focus involves a mathematical approach for the design and manufacture of general hypoid gear pairs. He currently teaches mechanism design, machine design, and senior capstone design. He is currently a member ASME, ASEE, and AGMA.



## Klingelberg

PARTNERS WITH SANDVIK COROMANT  
FOR TOOL CONCEPT PROJECT

Klingelberg GmbH (Germany) and Sandvik Coromant (Sweden) recently came together to work on a new tool concept for the Klingelberg Zyklo-Palloyd gear cutting process, designed to establish dry processing with carbide indexable inserts.

System supplier Klingelberg GmbH, a machine manufacturer in gear technology, and Sandvik Coromant, a provider of tool solutions, joined forces to offer customers end-to-end solutions that take into account and optimize the complete machine, comprising the machine, setting, cutting parameters and tool solution.

“Our goal, of course, is to realize innovative modifications to enable our customers to manufacture their products with maximum flexibility, shorter processing times and lower process costs,” said Dr. Tim Sadek, head of the tool machines product line at Klingelberg.

To accomplish this, both companies are blazing new trails in a joint effort. Together with Sandvik Coromant, Klingelberg has been at work developing a modern tool concept for the Klingelberg Zyklo-Palloyd gear cutting process, which will replace the proven system based on high speed steel materials.

“In the long term, we intend to establish dry processing in this gear cutting process as well, which will entail cost advantages, environmental aspects and ease of operation,” said Sadek.

Jointly conducted basic research and development is a tradition for these two companies. Both have been working on technological solutions in partnership since 2009 and together have developed solutions for hobbing with carbide indexing inserts for production readiness, which are currently on the market.

The partnership intensified in 2012, when both companies committed to the implementation of dry processing with carbide indexing inserts in the Zyklo-Palloyd gear cutting process.



## Rick Falgiatano

APPOINTED STAR SU VICE PRESIDENT OF  
CUTTING TOOL SALES

Star SU (Hoffman Estates, IL) recently appointed **Rick Falgiatano** as vice president of sales for its cutting tool division.

Falgiatano brings 35 years of experience in the cutting tool industry, including 20 years in sales management roles – most recently as district sales manager for Kennametal (Latrobe, PA). Falgiatano has gained expertise in milling and drilling, as well as managing channel partner distribution, integration and integrated programs.

Falgiatano attended the University of Phoenix (Warrenville, IL) and served as past president and charter board member of the Society of Carbide and Tool Engineers (SCTE) Rockford and Chicago chapters.

### For more information:

Star SU, LLC  
Phone: (248) 442-3137  
[www.star-su.com](http://www.star-su.com)



## Michael Cristodoulou

APPOINTED PRESIDENT AND COO OF  
WALTER SURFACE TECHNOLOGIES

Walter Surface Technologies (Windsor, CT) recently announced that **Michael Cristodoulou** has been appointed as president and chief operating officer of the company.

Prior to joining Walter, Cristodoulou was president of Cummins Eastern Canada LP, the distributor for Cummins Inc. Cristodoulou began working for Cummins in 1985 as general manager of parts. His career within this company took him from regional sales manager to president (Cummins Diesel of Canada), including, the position of executive director, PACCAR Business (Cummins - USA), before becoming head of the Cummins Eastern Canada business.

Over the course of his career, Cristodoulou had the opportunity to manage finance, HR, sales, marketing, manufacturing and distribution teams, as well as research and development operations. Cristodoulou has managed teams of up to 500 employees.

“Michael has had an impressive career,” said Pierre Somers, chairman and CEO of Walter Surface Technologies. “His entre-





preneurial skills and strategic vision will play an integral role in driving the business forward for Walter. Michael has a strong track record in delivering results and is a great addition to the team.”

“After more than two decades with Cummins, I am excited to take on a new challenge with Walter” said Christodoulou. “As Walter is a global leader in the metalworking industry, I look forward to engaging with our customers and to helping to drive growth in all of our key business segments.”

## Meghan Summers-West

NAMED PRESIDENT OF CNC SOFTWARE

**Meghan Summers-West** was recently appointed president of CNC Software, Inc. (Tolland, CT), the developer of Mastercam CAD/CAM programming software for CNC machine tools.



“As many people close to the Summers family know, this transition has been almost 32 years in the making,” said former president, now chairman, Mark Summers. “My daughter Meghan was born the same year that my brothers and I officially launched Mastercam and established CNC Software, Inc. in 1983. As a father, I am proud. As a business owner, and to all of you who have contributed so much of yourselves to make this company successful, I am wholly confident in this decision.

“For the majority of you who have watched Meghan grow up in these offices and have been impressed by her warm and direct leadership style, her curiosity and willingness to learn, her product knowledge, and her overall intelligence, I know that you are certain, too, that the future of our flagship product Mastercam and our organization is in very capable hands.”

Summers also said that with the consolidation of many CAD/CAM companies, this decision represents a continuation of CNC Software’s dedication to Mastercam and to Mastercam’s global customer base. He emphasized that appointing Summers-West also demonstrates that the company remains a private entity.

“Today is two things,” Summers-West said. “It’s an acknowledgement of all I have worked for and desired since I can remember. It’s also, more importantly, the beginning of the next 30-plus years for Mastercam and CNC Software. I am honored and excited to take on this role and to continue to work with the sincerest and smartest people in our industry – you and our dedicated and loyal worldwide reseller network and our bright, innovative customers.

“Mastercam plays a vital role in changing lives for the better. It’s used in all facets of industry, from helping to make life-saving medical devices for the human body to parts for planetary exploration, expanding our knowledge of the universe. Mastercam boosts personal and industrial productivity, sup-

## Spiral Bevel Gears

- Spiral & straight bevel gear manufacturing.
- Commercial to aircraft quality gearing.
- Spur, helical, splined shafts, internal & external, shaved & ground gears.
- Spiral bevel grinding.
- Midwest Transmissions & Reducers.
- ISO compliant.



Midwest Gear & Tool, Inc.  
15700 Common Rd., Roseville, MI 48066  
Tel: 586.779.1300 midwestgear@sbcglobal.net

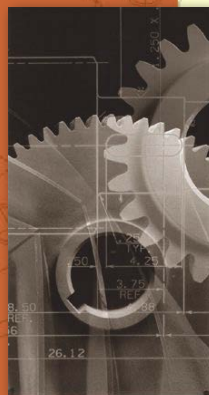


ACCU-DRIVE, INC.  
610 West Pershing Rd.  
Chicago, IL. 60609



### PRECISION GEAR GRINDING

- Spur / Helical up to 59" O.D. – 26" Face
- Accurate quotes – Competitive prices – Fast turn-around
- Emergency “breakdown” support
- Support system for OEM parts
- Full complement of testing equipment for complete and comprehensive charting. Calibrated and certified on a regular schedule.



Trusted by OEM, MRO and Gear Job Shop customers for nearly two decades.

Your project is as important to us as it is to you.

**(773) 376-4906**

[www.Accudrv.com](http://www.Accudrv.com)  
[gears@accudrv.com](mailto:gears@accudrv.com)

porting our global economy as a whole. Mastercam for educators and students helps train future machinists, engineers, and programmers – people who create, solve problems, and enjoy good incomes and satisfying careers.

“Mastercam touches almost every person in every place in some way. We are changing the world, one feature at a time. As such, my intention – with your valuable contributions – is to continue to evolve Mastercam by anticipating manufacturers’ and technology teachers’ needs and wants for decades to come.”

Summers-West has served as operations manager at CNC Software since 2009. She earned a Bachelor of Science degree in Business at Bentley College, Massachusetts and an MBA in Management at Hawaii Pacific University. In 2014, the Society of Manufacturing Engineers named her one of the “30 Under 30 Future Leaders of Manufacturing.” She serves on the Young Professionals Group for HVCC, the local food pantry and human services agency.

## OSG

### PROMOTES JONES TO VICE PRESIDENT-SALES

OSG USA, Inc. (Glendale Heights, IL) recently announced the promotion of **Rick Jones** to vice president-sales.

Jones joined the OSG sales team as a district manager in 1986, and he ascended to various leadership positions such as regional manager, area manager, and most recently, the national sales manager. Jones has overseen the national sales force of OSG’s cutting tool division as the national sales manager since 2013.

In his new role, Jones will also oversee the OSG fastener products division sales team in addition to cutting tool sales.

“With his 29 years of experience and guidance of OSG’s sales, we are certain that he will help OSG reach new heights,” said Mike Grantham, president of OSG.

OSG USA, Inc. is located in Glendale Heights, IL and is a subsidiary of OSG Corporation. OSG Corporation was founded in 1938 and is a publicly held company headquartered in Toyokawa, Japan.



## Oerlikon’s

### DRIVE SYSTEMS SEGMENT INAUGURATES THIRD PLANT IN INDIA

Oerlikon’s Drive Systems Segment recently inaugurated its third plant at Sanand in Gujarat, India. This is the 10th production facility for the Segment globally.

“This inauguration marks an important milestone for the further development of Drive Systems Segment in India,” said Dr. Bernd Matthes, CEO of Oerlikon’s Drive Systems Segment. “With the additional production capacity, we continue our

growth in India and further upgrade our capabilities in high-tech driven products.”

Oerlikon’s Drive Systems Segment has been present in India since 1999, with production sites of both its brands, Oerlikon Graziano and Oerlikon Fairfield, at Greater Noida and Belgaum, respectively.

“In less than two years after the ground breaking ceremony, we have commenced production at Sanand,” said Matthes. “With this new capacity we will continue our journey in India and upgrade our capabilities in high-tech driven products strongly supporting our customers in developing new innovative solutions for the domestic as well as international markets.”

Oerlikon’s Drive Systems Segment has grown from strength to strength in India over the last decade and a half. Today it serves domestic as well as export markets, covering not only the agricultural market, but also construction equipment, commercial and utility vehicles as well as industrial applications. The new plant is spread across 35 acres, and will employ more than 1,000 people when in full production.

“More than a third of the site has been planned to be ‘green,’” said Vivek Prakash, business unit head at Oerlikon’s Drive Systems Segment India. “We have an energy efficient building resulting in 30% reduction in energy requirements, plus zero discharge of water and 100% rain water harvesting and waste water management. We have built the plant to comply with LEED Gold Standard criteria and will be applying for certification shortly. We aspire to be sustainable in all aspects and emerge as the trendsetter amongst our peers in the region.”



## Kitagawa NorthTech

### HIRES DAVID HAWKING AS NATIONAL SALES AND MARKETING MANAGER FOR NORTH AMERICA

Kitagawa NorthTech (Schaumburg, IL) recently announced the hiring of **David Hawking** in the company’s newly created post of national sales and marketing manager for North America.

Hawking will be responsible for driving new sales revenue for Kitagawa NorthTech’s family of workholding and custom engineered solutions. Additionally, he will also be responsible for business development, sales team leadership and management of the company’s field sales, marketing and customer service teams.

Hawking comes to Kitagawa NorthTech with over 25 years of industrial sales experience. Most recently, in his former posi-





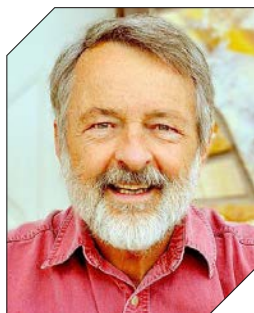
tion at TydenBrooks Security Products as North American sales manager, Hawking was responsible for sales and account management for many large customers of the company throughout North America. He also has sales and market development experience with several industries important for his new role at Kitagawa NorthTech including: aerospace, automotive, machine tool, metalworking, transportation, oil and gas, power generation, petrochemical, utilities and other general industrial markets.

“We are looking forward to David joining our sales management team and bringing his wealth of strategic sales and business development expertise and knowledge to Kitagawa NorthTech,” said Kenn Burns, vice president of Kitagawa NorthTech. “We are confident in his appointment as our national sales and marketing manager; he will be successful in generating new sales growth for our standard workholding and custom engineered solutions and in providing added value to our North American customers.”

## Robert Errichello

### WINS EDMOND E. BISSON AWARD

**Robert Errichello** (Park Ridge, IL) was recently announced as the winner of the 2015 Edmond E. Bisson Award, bestowed annually by the Society of Tribologists and Lubrication Engineers (STLE).



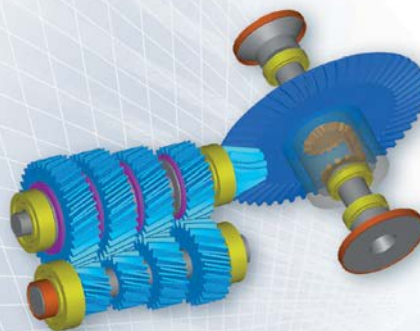
The award was for Errichello’s technical paper – “Investigations of Bearing Failures Associated with White Etching Areas (WEAs) in Wind Turbine Gearboxes.” The winning paper was also previously republished in its entirety in the March 2014 issue of *Power Transmission Engineering* magazine; Errichello is also a longtime contributor and technical editor for *Gear Technology* magazine.

The Bisson Award is named in honor of the late Edmond E. Bisson, the former STLE editor-in-chief whose contributions to the Society’s publications through the years helped to ensure its continuation and fulfill its purpose.

Established in 1991, the award is given annually to the STLE member(s) or non-member(s) for the best written contribution published by the Society in the year preceding the Annual Meeting. The contribution shall deal with tribology, lubrication engineering or allied disciplines. The STLE Awards committee made their selection after careful consideration of many fine candidates and papers. The committee’s recommendation was approved by the board of directors at its January 2015 meeting.

STLE president Maureen Hunter presented the award to Errichello at the Opening General Session on May 18 during the STLE 2015 Annual Meeting in Dallas, TX.

**KISSsoft**  
Calculation programs for machine design



**NEW**  
Release  
03/2015

### KISSsoft Highlights

- Risk assessment of flank fracture for cylindrical gears
- Contact analysis for bevel gears
- Planet carrier deformation with FE calculation
- Housing stiffness in KISSsys
- Modal analysis of shaft systems
- And many more ...

KISSsoft USA, LLC  
3719 N. Spring Grove Road  
Johnsburg, Illinois 60051  
Phone (815) 363 8823  
dan.kondritz@KISSsoft.com

Get your free trial version at  
[www.KISSsoft.com](http://www.KISSsoft.com)

**BEYTA GEAR SERVICE**

**PUTTING  
A LIFETIME**

**OF  
GEAR  
DESIGN  
EXPERIENCE**

**TO WORK FOR YOU**

- Reverse engineering
- Gearbox upgrades
- Custom gearbox design
- Specification development
- Project management
- Vendor qualification
- Design reviews
- Bid evaluations
- Tooling design
- Customized gear training
- Equipment evaluation
- Custom machine design

**Charles D. Schultz**  
[chuck@beytagear.com](mailto:chuck@beytagear.com)  
**[630] 209-1652**

[www.beytagear.com](http://www.beytagear.com)

# Doug Glenn

APPOINTED SECO/WARWICK'S  
DIRECTOR OF SALES AND MARKETING  
FOR NORTH AMERICA

Seco/Warwick Corporation (Meadville, PA) recently announced the appointment of **Doug Glenn** as the North American director of sales and marketing.

"Doug will head the company's sales and marketing network for the North American markets," said Jonathan Markley, Seco/Warwick Corp. managing director. "As the most fully integrated furnace man-



ufacturer in the world, we provide customer access to a wide range of heat treatment resources, including technology, engineering expertise and equipment manufacturing – Doug's industry experience and proven leadership will help us to provide seamless customer service."

Glenn was the publisher of Industrial Heating magazine for 20 years, (1994-2014). During that time he served on the board of directors of both the Industrial Heating Equipment Association (IHEA) and the Metal Treating Institute (MTI) serving a year as president of the latter.

In addition to being one of two founders of Furnaces North America (1996), Glenn and his staff at Industrial Heating started Chinese and Brazilian editions of Industrial Heating, as well as created FORGE magazine, one of the forging industry's leading trade publication. Glenn also founded the Industrial Heating's Economic Indicators that serve as the industry's only industry-specific economic indicators.

# Aichelin-USA

INSTALLS INTEGRAL QUENCH  
FURNACE CELL

Aichelin-USA (Plymouth Charter Township, MI) recently announced the installation of a new multi-chamber Integral Quench hardening furnace cell.

The recently commissioned furnace system includes pre/post-washer, pre-oxidizing furnace, endothermic gas genera-



tor and a chamber gas fired I/Q furnace consists of one loading, two high heat neutral hardening and one oil quench chamber. Afterwards components are washed and tempered. The furnace system is fitted with a moveable cart for loading and unloading tray for each unit.

Aichelin is a provider multi-chamber I/Q furnaces that incorporate a pre-oxidizing and pre heating chambers for faster cycle times, better use of floor space and flexibility in heat treating a wide range of components.

The installed cell was built in the USA and is fully automated with a SCADA system. Aichelin also provided the hoods, stacks, guarding and turnkey installation.

The customer is based in the Southwest USA and has plans for an additional system in the future.

# Holroyd Precision

RECEIVES A QUEEN'S AWARD FOR  
ENTERPRISE

Rochdale-based Holroyd Precision Ltd (United Kingdom) was recently named a winner of the Queen's Award for Enterprise, the UK's highest accolade for business success.

Holroyd received the award for International Trade, having achieved year-on-year growth in exports. It was given in recognition of the company's achievements in developing new markets globally, creating new machine tool technologies with particular focus on those markets, and for Holroyd's successes in exporting its specialized grinding and milling machines to organizations



around the world. Over the last few months alone, Holroyd has secured export orders worth in excess of £7 million.

"We are extremely proud and honoured to have won what is clearly the UK's most prestigious business award," said Holroyd Precision's Chief Executive Officer, Dr. Tony Bannan. "In securing the award, we were able to demonstrate significant growth in overseas trade, something that was achieved in spite of challenging global trading conditions. I would like to thank our staff here in Rochdale and our various support teams globally for the hard work and dedication that has made winning the Queen's Award possible."

Holroyd's recent £3 million development of the Zenith 400 helical profile grinding machine – a technology that has already resulted in orders from the USA, China and Germany – is just one example of its commitment to investment.

The company has a track record of investing in young people at its Rochdale HQ and for ongoing research into milling and grinding technologies at postgraduate and post-doctoral level.



# FEELING SOCIAL?

Interact with your Gear Industry peers at [www.geartechnology.com](http://www.geartechnology.com).

- Gear Technology blog
  - Ask the Expert
- Follow us on Twitter
- Join the *Gear Technology* group on LinkedIn (1,100 members and growing!)



Follow us on Twitter  
[twitter.com/#!/Gear\\_Technology](https://twitter.com/#!/Gear_Technology)



Connect with us on LinkedIn  
[www.linkedin.com/groups/Gear-Technology-Magazine-3893880](http://www.linkedin.com/groups/Gear-Technology-Magazine-3893880)



Subscribe Online  
[www.geartechnology.com/subscribe.htm](http://www.geartechnology.com/subscribe.htm)

### June 9-11 – 2015 Bevel Gear System Design: Manufacture, Heat Treatment, Inspection, & Application

Hyatt Rosemont, Rosemont, IL. The purpose of this seminar is to prepare participants to design and apply bevel gears systems from the initial concept through manufacturing and quality control and on to assembly, installation and maintenance. It is not a theoretical presentation of bevel gear theory rather it is a practical hands on guide to their design, manufacture, quality control, assembly, installation rating, lubrication and, most especially, application. Instructor is Raymond J. Drago. Entry fee is \$1,395 for members and \$1,895. For more information, visit [www.agma.org](http://www.agma.org).

### June 15-17 – Gear Failure Analysis June 2015

Big Sky Resort, Big Sky, MT. The Gear Failure Analysis seminar provides participants the skills necessary to diagnose gear failures and prescribe remedies. This presentation covers six classes of gear tooth failure: overload, bending fatigue, hertzian fatigue, wear, scuffing, and cracking. Each failure mode is illustrated by color slides and field samples because of the magnification inherent in slide projection. However, it is important to examine the field samples because there is no substitute for hands-on experience that students experience. Working in small groups, students participate in a hands-on practical exam using field samples and a case study. For more information, visit [www.agma.org](http://www.agma.org).

### June 15-17 – Western Manufacturing Technology Show

Edmonton EXPO Centre, Edmonton, Alberta, Canada. True to its name, WMTS targets the specific needs of manufacturers in Western Canada. Ever-evolving technology, unique economic challenges, and the heavy influence of the oil and gas industry present a diverse mix of circumstances—and WMTS is up to the task of meeting them. A showcase of top solution providers, the WMTS has the answers attendees are searching for. Walk the show floor and meet face-to-face with the experts who can explain how applying new methods and advanced technology can improve operations and margins. Leading-edge machine tools, tooling and accessories, fabrication, design, automation, process control, and plant maintenance equipment—it's everything businesses need all under one-roof. Combined with an industry keynote, an interactive town hall panel and limitless opportunities to network and share ideas with like-minded colleagues, WMTS is a complete manufacturing experience that will give attendees the practical knowledge needed to stay competitive in Western Canada. For more information, visit [www.wmts.ca](http://www.wmts.ca).

### June 23-24 – Liebherr Gear Seminar

ITC Technical Center, Rockford, Illinois. Co-hosted by Ingersoll Cutting Tools, this event will feature technical presentations of the latest developments in gear cutting and inspection technology by experts from Liebherr Gear Technology, Liebherr Automation Systems, Ingersoll Cutting Tools, Saacke Group, and the Wenzel Group. The Gear Seminar is a well-regarded bi-annual event conducted for nearly 20 years by Liebherr Gear Technology, a leading global developer of advanced gear production machines, tools and processes. Parent company Liebherr Verzahntechnik GmbH is headquartered in Kempten, Germany. In addition, qualified guests will tour the Ingersoll shop floor and witness a hobbing demonstration on Liebherr's LC 500. For more information, visit [www.liebherr-emo.com](http://www.liebherr-emo.com).

**July 14-16 – SEMICON West 2015** Moscone Center, San Francisco, CA. SEMICON West is the premier annual event for the global microelectronics industry, highlighting the latest innovations, products, processes, and services for the design and manufacture of today's most sophisticated electronics. SEMICON West showcases innovations across the microelectronics supply chain, from silicon to system and everything in between. From the latest research on the cutting-edge of transistor technology, to solutions breathing new life into legacy fabs, SEMICON West is the place to connect to what's new and what's next in microelectronics. For more information, visit [www.semiconwest2015.org](http://www.semiconwest2015.org).

### August 6-8 – Asia International Gear Transmission Expo 2015

As Asia's most influential, professional and authoritative gear industry event, GTE has been held 10 years in a row and during that time has obtained the affirmation of a large number of exhibitors and buyers. The exhibition will work with multiple marketplace platforms to create the Asia gear industry's most influential international showcase. With a planned area of 45,000 square meters, the exhibition expects more than 500 exhibitors and 40,000 professional visitors from home and abroad. For more information, visit [www.gte-asia.com](http://www.gte-asia.com).

### September 13-15 – TECHINDIA 2015

Bombay Exhibition Centre, Mumbai, India. TECHINDIA will be the ultimate facilitator for b2b cooperation between manufacturers and consumers of all hues connected to the engineering, machinery and manufacturing industry. This leading business event is co-located with five other industry events to make it an extended platform for metal, engineering, manufacturing and machine tools industry: World of Metal – International Exhibition on Metal Producing, Metal Processing and Metal Working Industry; CWE – International Exhibition on Cutting and Welding Equipment; IMEX – International Exhibition on Machine Tools and Engineering Products; UMEX – International Exhibition on Used Machineries; Hand Tools and Fasteners Expo – International Exhibition on Hand Tools and Fasteners. The co-location of industry events will maximize business opportunities for industry professionals. For more information, visit [techindiaexpo.com](http://techindiaexpo.com).

### September 16-18 – Rocky Mountain Gear Finishing School

Kapp Technologies, Boulder, CO. The Rocky Mountain Gear Finishing School (RMGFS) is a multi-layered program designed to optimize learning and strengthen your understanding of gear finishing processes no matter your experience level. Rocky Mountain Gear Finishing School covers advancements in profile and generating grinding technology in a classroom setting but also through hands-on demonstrations. Participants learn about the principles and mechanics of different gear finishing processes and then have the opportunity to discuss them in smaller workshops as well as see them demonstrated. Visit [www.kapp-usa.com/rmgfs](http://www.kapp-usa.com/rmgfs).

### September 28-October 1 – Gear Dynamics and Gear Noise Short Course

Fawcett Center, The Ohio State University, Columbus, OH. The purpose of this 4-day course is to provide a better understanding of the mechanisms of gear noise generation, methods by which gear noise is measured and predicted, and techniques employed in gear noise and vibration reduction. Over the past 36 years more than 1,850 engineers and technicians from over 360 companies have attended the Gear Noise Short Course. \$2,150 per person. For more information, visit [www.nvhgear.org](http://www.nvhgear.org).



# gear

TECHNOLOGY



## FREE SUBSCRIPTION

You have been selected to receive this FREE sample copy of *Gear Technology*, the world's leading publication on gear design, engineering and manufacturing. Please read through it, and if you like what you see, sign up for a **FREE SUBSCRIPTION** using the form below.

**FIND THE EXACT SUBJECTS YOU ARE LOOKING FOR:** Subscribers now get access to the 30 years of searchable articles in our online archive.

**1**  **YES** I want to receive/continue to receive ***Gear Technology* FREE!**  
 No thank you.

Name: \_\_\_\_\_ JobTitle/Position: \_\_\_\_\_  
(print)

Signature \_\_\_\_\_ Date: \_\_\_\_\_  
(required)

**2** → E-mail \_\_\_\_\_  
(So we can notify you when the online edition is available)

**3** → Please update your contact information or attach you business card here. (No Staples)

Company Name: \_\_\_\_\_  
Address: \_\_\_\_\_  
\_\_\_\_\_  
City: \_\_\_\_\_  
State/Province: \_\_\_\_\_ ZIP+4/Postal Code: \_\_\_\_\_  
Country: \_\_\_\_\_  
Telephone: \_\_\_\_\_ Fax: \_\_\_\_\_  
E-mail: \_\_\_\_\_  
Website: \_\_\_\_\_

**5** → My company's principal product or service is: \_\_\_\_\_

**6** → How are YOU involved with gears (check all that apply)?

My company MAKES gears (20)  
 My company BUYS gears (22)  
 I DESIGN gears (23)  
 I am a SUPPLIER to the GEAR INDUSTRY (please specify product or service) (24)

I ONLY want the digital edition (e-mail required)

**4** → What is your primary JOB FUNCTION (check ONLY one)

<input type="checkbox"/> Corporate Executive (B)	<input type="checkbox"/> Purchasing (L)
<input type="checkbox"/> Manufacturing Production Management (C)	<input type="checkbox"/> Marketing, Sales or Communications (M)
<input type="checkbox"/> Manufacturing Production Department (D)	<input type="checkbox"/> Quality Control Management (P)
<input type="checkbox"/> Manufacturing Engineering Management (E)	<input type="checkbox"/> Quality Control Department (Q)
<input type="checkbox"/> Manufacturing Engineering Department (F)	<input type="checkbox"/> Other (Please describe) (N)
<input type="checkbox"/> Product Design, R&D Management (H)	
<input type="checkbox"/> Product Design, R&D Department (I)	



Is there a colleague within your company that might benefit from having their own copy of ***Gear Technology*** magazine?

Name: \_\_\_\_\_

Title: \_\_\_\_\_

### DIGITAL SUBSCRIPTIONS

- YES**, I want to be notified each issue when *Gear Technology* is available online
- YES**, I would like to receive *Gear Technology's* monthly e-mail newsletter
- YES**, I would like to receive *Gear Technology's* twice monthly e-mail Product Alerts
- YES**, I would like to receive 3rd-party e-mails from *Gear Technology's* advertisers and partners
- YES**, I would like to receive subscription renewal notices by e-mail
- No**, I do not wish to be contacted by e-mail.

**FAX TO 1-847-437-6618 or  
VISIT US ONLINE AT**

**[www.geartechnology.com/subscribe.htm](http://www.geartechnology.com/subscribe.htm)**

**3M Abrasives** – page 20  
[www.3M.com/PrecisionGTAug](http://www.3M.com/PrecisionGTAug)

**Accu-Drive Inc.** – page 63  
[www.accudrv.com](http://www.accudrv.com)

**AGMA (Gear Expo)** – page 39  
[www.gearexpo.com](http://www.gearexpo.com)

**All Metals & Forge Group, LLC** — page 23  
[www.steelforge.com](http://www.steelforge.com)

**B&R Machine & Gear Corp.** — page 17  
[www.brgear.com](http://www.brgear.com)

**Beyta Gear Service** – page 65  
[www.beytagear.com](http://www.beytagear.com)

**The Broach Masters & Universal Gear** – page 29  
[www.broachmasters.com](http://www.broachmasters.com)

**Circle Gear** – page 71  
[www.circlegear.com](http://www.circlegear.com)

**DMG Mori** – page 35  
[www.dmgmori.com](http://www.dmgmori.com)

**DTR Corp.** — page 13  
[www.dragon.co.kr](http://www.dragon.co.kr)

**Erasteel** – page 33  
[www.erasteel.com](http://www.erasteel.com)

**Forest City Gear** — page 7  
[www.forestcitygear.com](http://www.forestcitygear.com)

**Framo Morat** – page 4  
[www.framo-morat.com](http://www.framo-morat.com)

**Gear Expo (AGMA)** – page 39  
[www.gearexpo.com](http://www.gearexpo.com)

**The Gear Machinery Exchange** – pages 70, 71  
[www.gearmachineryexchange.com](http://www.gearmachineryexchange.com)

**German Machine Tools of America** – page 21  
[www.gmtamerica.com](http://www.gmtamerica.com)

**Gleason Corp.** — pages 36-37  
[www.gleason.com](http://www.gleason.com)

**Goldstein Gear Machinery** – pages 70, 71  
[www.goldsteingearmachinery.com](http://www.goldsteingearmachinery.com)

**Hans-Jürgen Geiger Maschinen-Vertrieb GmbH** – page 41  
[www.geiger-germany.com](http://www.geiger-germany.com)

**Index Technologies** – page 71  
[www.gallenco.com](http://www.gallenco.com)

**Ipsen International** —page 11  
[www.ipsenusa.com](http://www.ipsenusa.com)

**Kapp Technologies** — page 3  
[www.kapp-usa.com](http://www.kapp-usa.com)

**KissSoft** – page 65  
[www.kisssoft.com](http://www.kisssoft.com)

**Klingelberg** — Outside Back Cover  
[www.klingelberg.com](http://www.klingelberg.com)

**Koro Sharpening Service** – page 71  
[www.koroind.com](http://www.koroind.com)

**Liebherr** – page 5  
[www.liebherr.com](http://www.liebherr.com)

**McInnes Rolled Rings** — page 19  
[www.mcinnesrolledrings.com](http://www.mcinnesrolledrings.com)

**Micro Surface Corp.** – page 71  
[www.ws2coating.com](http://www.ws2coating.com)

**Midwest Gear & Tool Inc.** — page 63  
[midwestgear@sbcglobal.net](mailto:midwestgear@sbcglobal.net)

**Mitsubishi Heavy Industries** — page 8  
[www.mitsubishigearcenter.com](http://www.mitsubishigearcenter.com)

**Nachi America** – page 31  
[www.nachi-america.com](http://www.nachi-america.com)

**Nordex Inc.** – page 30  
[www.nordex.com](http://www.nordex.com)

**Pentagear Products** – page 40  
[pentagear.com](http://pentagear.com)

**Phoenix Tool & Thread Grinding** – page 71  
[www.phoenixthreadgrinding.com](http://www.phoenixthreadgrinding.com)

**Presrite Corp.** — page 18  
[www.presrite.com](http://www.presrite.com)

**Proto Manufacturing** – page 14  
[www.protoxrd.com](http://www.protoxrd.com)

**Rave Gears & Machining** – page 15  
[www.ravegears.com](http://www.ravegears.com)

**Schnyder S.A.** — page 4  
[www.hanikcorp.com](http://www.hanikcorp.com)

**Seco Tools** – page 16  
[www.secotools.com/us](http://www.secotools.com/us)

**SMT—Smart Manufacturing Technology** – Inside Back Cover  
[masta.smartmt.com](http://masta.smartmt.com)

**Star SU LLC** — pages IFC–1, 71  
[www.star-su.com](http://www.star-su.com)

**TECO Werkzeugmaschinen GmbH & Co. KG** – page 25  
[www.teco-germany.com](http://www.teco-germany.com)

**ZRIME** – page 12  
[www.zrime.com.cn](http://www.zrime.com.cn)

# GLEASON GEAR EQUIPMENT

## GENERATORS

**Model 645 Hypoid Generators**, loaded with every option, from Aircraft 1980

**Model 26 Hypoid**, Rough & Finish Cams, Modified Roll, from Aircraft

**Model 642 G-Plete, Hypoid** 13" (330 mm), Helical Motion, FORMATE, Excellent, 1982

**Model 116 & 118 Hypoid**, Rough & finish Cams, FORMATE, from Aircraft 1967 & 1966

**Model 106 & 108 Hypoid**, Rough & finish Cams, Helical Motion, FORMATE, from Aircraft 1960 & 1964

**Model 14 Coniflex Straight Rough & Finish**, Complete

## TESTERS

**Model 27M Hypoid** 30.5" (925 mm), #60/#39 Tapers, From Aircraft, 1961

**Model 502 Hypoid** 10.5"/6" (270 mm/155 mm) #39/#14 Tapers From Aircraft, 1964

**Model 13 Universal**, 13" (335 mm) #18 From Aircraft

**Model 6 Split Head Universal**, 7.5" (190 mm) From Aircraft, 1958 & 1966

**Model 6 Solid Head Universal**, 7.5" (190 mm), From Aircraft



GEAR  
MACHINERY  
EXCHANGE.COM

[www.gearmachineryexchange.com](http://www.gearmachineryexchange.com)



**KORO** for Quality  
**Hob Sharpening Service**

- ◆ Quick Turnaround 2 Day Service
- ◆ Spur Shaper Cutter Sharpening
- ◆ HSS & Carbide Hob with center hole and straight flutes
- ◆ Thin Film Coatings
- ◆ Length up to 7 inches
- ◆ Diameter up to 5 Inches
- ◆ Precise rake and spacing guaranteed to AGMA standards
- ◆ **RUSH SERVICE AVAILABLE**

Koro Sharpening Service  
 9530 85<sup>th</sup> Ave North  
 Maple Grove, MN 55369  
 763-425-5247  
 info@koroind.com

**PHOENIX**  
 TOOL & THREAD GRINDING

- CNC External Thread Grinding Specialists
- Emergency Service Available
- Any thread form
- Any lead
- Multiple starts

4760 Briar Rd, Cleveland, OH 44135  
 Phone: 216-433-7008 Fax: 216-433-7067  
 Phoenixgrinding@gmail.com  
[www.PhoenixThreadGrinding.com](http://www.PhoenixThreadGrinding.com)

**Sharpening Service**  
 for hobs, milling cutters, shaper cutters, shaving cutters and broaches

Service locations in:

- Hoffman Estates, IL  
 Tel: 847.649.1450 Fax: 847.649.0112
- East Tawas, MI  
 Tel: 989.362.0414 Fax: 989.362.2720
- Querétaro, México  
 Tel: 52 442 217 34 45  
 Fax: 52 442 217 34 46

 sales@star-su.com  
 www.star-su.com

**QUALITY CUSTOM GEARING!**

Documented Quality Control Program

Inspection Lab including Complete Gear Tooth Diagnostics

**Tooth Cutting, Grinding & Shaving Services Available**


**All Sizes & Configurations**

- Reverse Engineering
- Design Analysis
- Complete Machine Shop Including CNC Machining

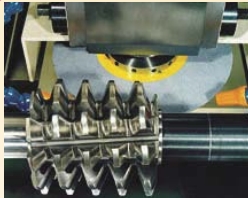
 **Circle Gear and Machine**  
 Since 1951  
 1501 South 55th Ct. • Cicero, IL 60804  
 Ph: 708-652-1000 • Fax: 708-652-1100

Please email your inquiries to sales@circlegear.com • [www.circlegear.com](http://www.circlegear.com)

**HEY #3 Milling & Centering Machines,**  
 27"cc, 15HP, 1980  
 51"cc, 10HP, 1980

  
**GEAR MACHINERY EXCHANGE.COM**  
[www.gearmachineryexchange.com](http://www.gearmachineryexchange.com)

**SHARP HOBS**  
 Change Downtime To Productivity



You Need Your Tools Back **FAST**  
 – Eliminating Downtime & Tuned To Meet or Surpass Original Design Specs and That's Where We Come In


- Stripping & Re-Coating
- Gear Shaper Sharpening
- Milling Cutter Sharpening
- Gear Tool Certifications

  
**Index Technologies**  
 Gear Tool Reconditioning

Tel: 216-642-5900 • Fax: 216-642-8837 • 5755 Canal Road • Valley View, OH 44125  
 Email: gallen@gallenco.com [WWW.GALLENCO.COM](http://WWW.GALLENCO.COM)

**Dry Lube Coating**

- WS<sub>2</sub>
- MoS<sub>2</sub>
- PTFE

  
**MICRO SURFACE CORPORATION**

Call on **MicroSurface** for unbeatable prices!  
 CALL: (408) 723-0700  
 info@ws2coating.com

# Henry Maudslay

## “A Founding Father of machine tool technology”

Jack McGuinn, Senior Editor

**H**ere is some history that bears repeating—or at least re-reading. So take a few minutes to give it up for a long-gone Brit named Henry Maudslay (August 22, 1771 – February 14, 1831)—also known as “A Founding Father of Machine Tool Technology.” You might also consider him an early leader in inspection, as he also invented the first bench micrometer capable of measuring to one ten-thousandth of an inch (0.0001 in  $\approx$  3  $\mu$ m). Maudslay dubbed it the “Lord Chancellor,” as it was used to settle any questions regarding accuracy of workmanship.

Maudslay was the son of a wheelwright in the Royal Engineers who was later a storekeeper. Like many boys of his era, Henry began his work in manufacturing quite young. Upon his father’s death around age 12, he worked as a “powder monkey” at the Royal Engineers Arsenal—i.e., one who filled cartridges at the facility. Within two years he was transferred to the carpenter’s shop, followed by the blacksmith’s shop, where at 15 he began training as a blacksmith. His innate skills allowed him to specialize in the lighter, more complex kind of forge work.

Seemingly born for the work, Maudslay excelled at his craft—so much so that Joseph Bramah (inventor of the hydraulic press) recruited him to work in his shop. Bramah had recently designed and patented an improved type of lock based on the tumbler principle, but was having difficulty in manufacturing the complex lock at reasonable cost. Although only 18, Maudslay quickly demonstrated his ability and was retained in Bramah’s employ. It was Maudslay who built the lock that was in Bramah’s shop window with a notice offering a reward of 200 guineas to anyone who could pick it. Maudslay designed and made a set of special tools and machines that allowed the lock to be made cost-effectively. It resisted all efforts to open it for 47 years.

Bramah had also designed a hydraulic press, but again was having problems closing the deal—this time in sealing both the piston and the piston rod where it fitted into the cylinder. Maudslay designed a leather cup washer that provided a perfect seal. The new hydraulic press worked perfectly thereafter, but again, Maudslay received little recognition—monetarily or otherwise.


When Maudslay first began working for Bramah, the typical lathe was worked by a treadle and the workman held the cutting tool against the workpiece. Precision was almost an afterthought—especially when cutting iron. Maudslay designed a tool holder into which the cutting tool would be clamped and would slide on accurately planed surfaces to allow the cutting tool to move in either direction. The slide

rest was positioned by a lead-screw to which power was transmitted through a pair of changeable gears so that it traveled in proportion to the turning of the work. This allowed screw threads to be precisely cut. Changing the gears gave various pitches. As knowing readers will appreciate, the ability of Maudslay’s slide-rest lathe to produce precision parts revolutionized the production of machine components.

While not its inventor, Maudslay *was* in fact the first to combine the slide rest, lead-screw, *and* change gears in a precision machine—which popularized the concept and caused modern industry to widely adopt it. Maudslay’s original screw-cutting lathe is at the Science Museum in London.

It was in 1797—with Maudslay having toiled for Bramah for eight very productive years—that trouble visited Paradise. Maudslay dared one day to ask for an increase in his wage of only 30s a week. Pennywise, pound-stupid, Bramah refused. Maudslay’s next career move was to set out on his own. He first rented a small shop, and then in 1800 moved to larger premises on Cavendish Square. His first major commission was to build a series of 42 woodworking machines to produce wooden rigging blocks (an order of some magnitude) for the Navy under Sir Marc Isambard Brunel. The machines were installed in the purpose-built Portsmouth Block Mills—which still survive, including some of the original machinery. The machines were capable of making 130,000 ships’ blocks a year, needing only ten unskilled men to operate them, compared with the 110 *skilled workers* needed before their installation. This was the first commonly known example of specialized machinery leading to downsizing.

Maudslay went on to develop in 1800 the first work-practical screw-cutting lathe, thus introducing the very first standardized screw sizes and threads. Until now, screw threads were usually made freehand by chipping and filing with chisels and files. Maudslay standardized the screw threads used in his workshop and produced sets of taps and dies that would make nuts and bolts consistently to those standards, so that any bolt of the appropriate size would fit any nut of the same size—yet another breakthrough.

Henry Maudslay played his part in the development of mechanical engineering when it was in its infancy, but the “Founding Father of Machine Tool Technology” was especially pioneering in the development of machine tools to be used in factories, job shops, and other end-user facilities around the world. (Sources: [britannica.com](http://britannica.com); [todayinscience.com](http://todayinscience.com).) 

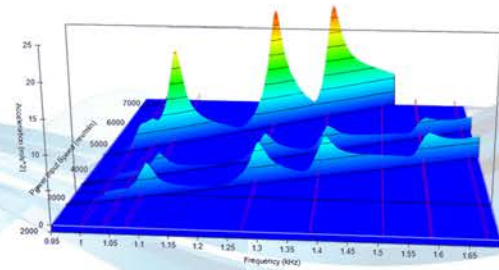
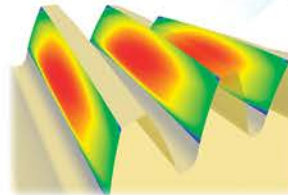
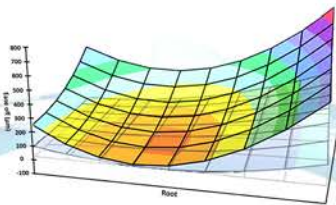




# MASTA

*Empowering engineers to achieve new levels of quality in a fraction of the time!*

AUTOMOTIVE | ENERGY | AEROSPACE | MARINE | INDUSTRIAL



*Of all the decisions I've made over the 40 years working for Joy Global, picking MASTA as our gearcase design software is without doubt the best one!*

MARK L ZIEGLER, PE. - PRINCIPAL ENGINEER

- Accurately and rapidly design transmission systems from scratch or imported concepts
- Comprehensively understand the life of a mechanical part over the customer duty cycle
- Identify potential failure modes early in the product development cycle
- Rapidly predict key performance characteristics at the design stage
- Easily explore changes in transmission layout, component selection and/or design, materials and manufacturing processes in the convenience of a virtual environment
- Perform full system simulations for any transmission or driveline configuration
- Incorporate manufacturing simulation at the design stage to reduce process development time & cost

Evaluate our software and discover for yourself  
Call +44 (0)115 941 9839  
or visit [masta.smartmt.com](http://masta.smartmt.com)

**SMT**   
SMART MANUFACTURING TECHNOLOGY

# HIT THE MARK.



MAXIMUM ACCURACY SOLUTIONS  
FOR BEVEL GEAR MANUFACTURERS  
BY KLINGELBERG



All over the world gear manufacturers highly appreciate Klingelberg solutions. With an Oerlikon spiral bevel gear cutting machine C 50 for gears up to 500 mm in diameter you "draw the bow" like no one else. Combined with a Klingelberg P 65 measuring center, which totally fits to the Oerlikon cutting machine C 50 due to interacting software components, you "hit the mark" with the highest precision.

Take your advantages in gear manufacturing with the accuracy of Klingelberg solutions.

Hit The Mark:  
[www.klingelberg.com](http://www.klingelberg.com)  
[www.hofler.com](http://www.hofler.com)

KLINGELBERG America, Inc.  
p. +1 734 470 6278  
e. [usa.sales@klingelberg.com](mailto:usa.sales@klingelberg.com)

## NEXT FAIRS:



Metalloobrabotka  
May 25 - 29, 2015  
Moscow, Russia



EMO  
October 05 - 10, 2015  
Milan, Italy

SUBJECT TO CHANGES.

**OERLIKON**

BEVEL GEAR TECHNOLOGY

**HÖFLER**

CYLINDRICAL GEAR TECHNOLOGY

**KLINGELBERG**

MEASURING TECHNOLOGY

**KLINGELBERG**

DRIVE TECHNOLOGY