

# gear

TECHNOLOGY®

JUN  
2015

## EMBRACE THE GRIND

THE LATEST DEVELOPMENTS  
THAT ARE MAKING GEARS  
QUIETER, FASTER, STRONGER

PLUS  
PRECISION GEARING LIGHTENING  
THE OFF-HIGHWAY LOAD



# Samputensili G 250 generating and profile grinding machine

The Samputensili G 250 gear grinding machine has been especially developed for very low cycle times and for top-quality and efficient mass production of gears with outside diameters up to 250 mm and shafts with lengths up to 550 mm.

The machine is based on the dual work spindle concept, which eliminates non-productive times almost completely. By means of this feature, the loading/unloading process of a workpiece is carried out in masked time, while simultaneously the manufacturing process proceeds on another workpiece. Simple design concepts in terms of tooling and dressing technology, fast automation and amazing user friendliness are the strengths behind this innovative machine.



**SAMPUTENSILI**

Phone: 847-649-1450 • [sales@star-su.com](mailto:sales@star-su.com)

5200 Prairie Stone Pkwy. • Ste. 100 • Hoffman Estates • IL 60192

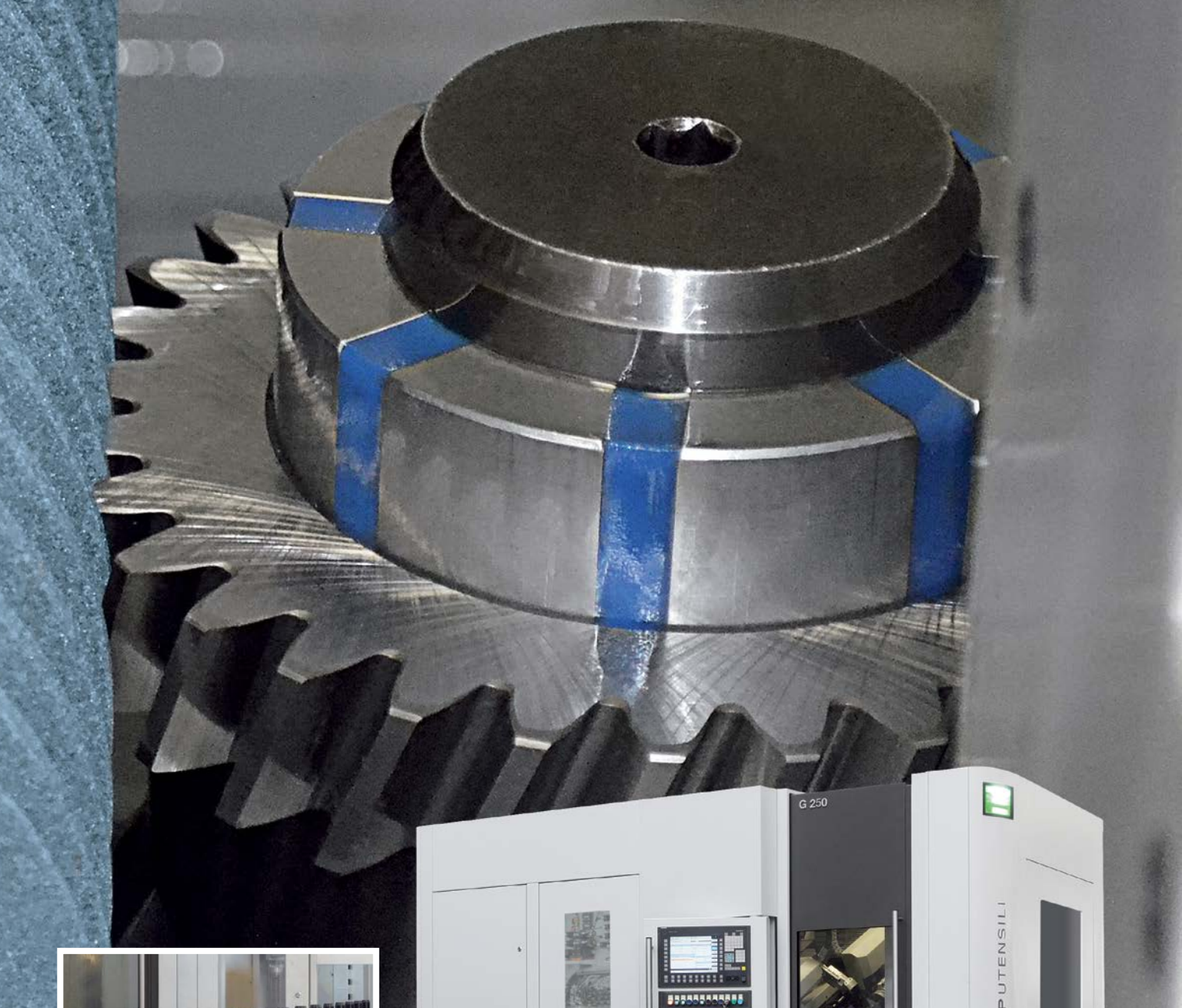

The G 250 / G 450 can be easily equipped with various automation solutions



[www.star-su.com](http://www.star-su.com)



30



20

## features

### 20 Gear Grinding is Getting Easier, Better, Faster, Stronger

NEO modifications, polish grinding among the latest grinding developments.

### 30 Precision Gearing Lightens Load for Off-Highway Equipment

Smoother surface finishes, tighter tolerances provide better tooth-to-tooth contact.

### 34 Off-Highway or Off-Press, Andantex Focuses on Precision

One supplier's take on precision gearing for varied markets.

## technical

### 38 Ask the Expert

Question 1: Gear pairs: setting and checking for mesh.  
Question 2: Evaluating NVH.

### 40 "Introduction to Gear Theory;" First in Series of Chapters from Hermann Stadtfeld's New Gear Book — Gleason Bevel Gear Technology.

### 48 Test Facility Simulation Results for Aerospace Loss-of-Lubrication of Spur Gears

A detailed study of the thermal environment in spur gears during loss of lubrication.

### 54 Optimal Modifications on Helical Gears for Good Load Distribution and Minimal Wear

Wear effects of cratering on helical gear teeth.

### 60 An Approach to Pairing Bevel Gears from Conventional Cutting Machine with Gears Produced on 5-Axis Milling Machine

New method to automatically find optimal topological modification from predetermined measurement grid points for bevel gears.

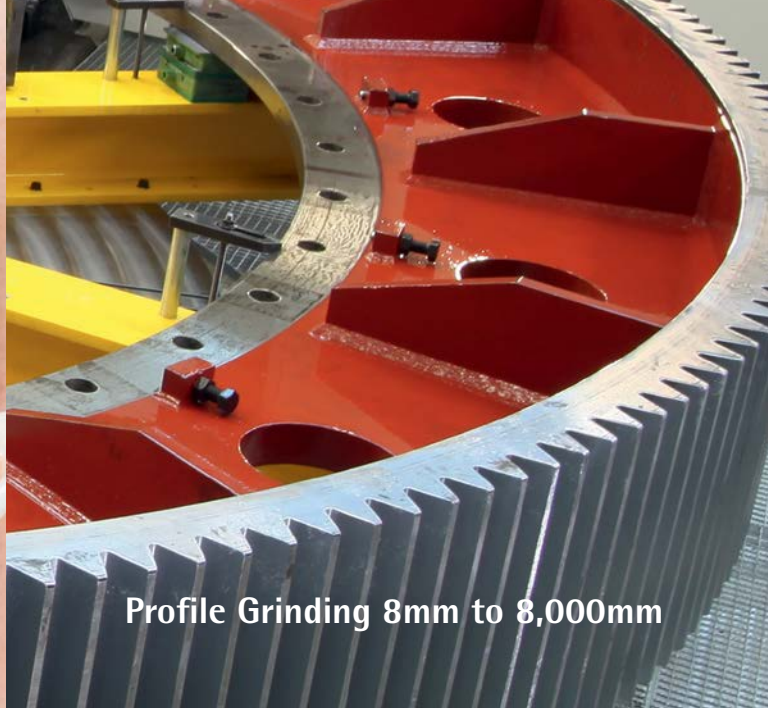

Generating Grinding 8mm to 1,250mm

Profile Grinding 8mm to 8,000mm

# Handling all your grinding needs... the Smallest and the Largest.



## KAPP KX 100 DYNAMIC

So small you could keep it in your garage (really)



## NILES ZP 80

A machine so large you could park a Cessna Skyhawk in it. (really)



**BOOTH 2222**

October 20–22  
Cobo Center  
Detroit, Michigan

KAPP Technologies  
2870 Wilderness Place Boulder, CO 80301  
Phone: (303) 447-1130 Fax: (303) 447-1131





# KAPP NILES



[www.kapp-niles.com](http://www.kapp-niles.com) [info-usa@kapp-niles.com](mailto:info-usa@kapp-niles.com)

**GEAR CUTTING TOOLS**   
**MADE IN SWITZERLAND**

**SCHNYDER** **HANIK**  
 GEAR CUTTING SOLUTIONS **CORPORATION**  
 60 YEARS OF TOP TECHNOLOGY

US Distributor  
 PHONE 630-595-7333  
 FAX 630-595-7343  
 www.hanikcorp.com  
 email: hanikcorp@aol.com



ph: 011-41-32-344-0400 • fax: 011-41-32-344-0404 • www.schnyder.com • mail@schnyder.com

# gear

TECHNOLOGY Vol. 32, No. 4

## departments

- 06 GT Extras**  
The *Gear Technology* Archive. This month we're highlighting Inspection and Grinding.
- 09 Publisher's Page**  
Good morning, class.
- 10 Product News**  
The newest hardware and software
- 66 Industry News**  
New equipment, expansions, accreditations and patents.
- 69 Calendar of Events**  
Upcoming events for the gear industry.
- 70 Advertiser Index**  
How and where to reach every advertiser in this issue.
- 71 Classifieds**  
Our products and services marketplace.
- 72 Addendum**  
Introducing the fixie, the coolest thing on two wheels.

 **Transmission expert.** 

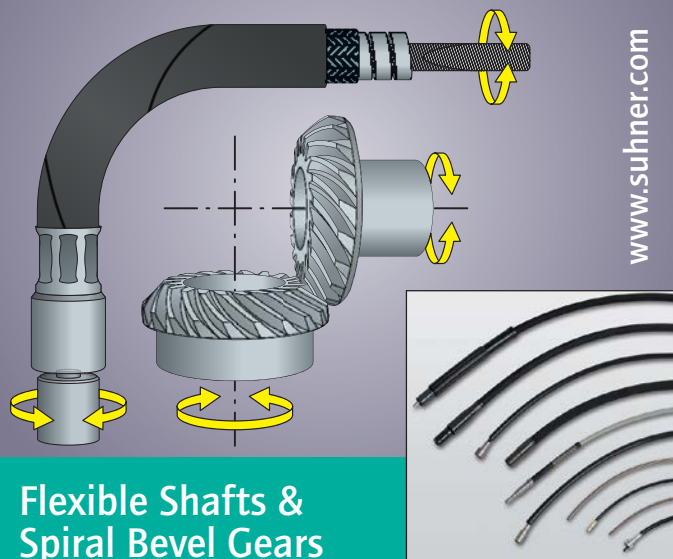

**Flexible Shafts & Spiral Bevel Gears**

Two different ways to transmit rotary motion.

**SUHNER**

SUHNER Manufacturing Inc. · Rome, GA 30161  
 Phone: 706-235-8046 · info.usa@suhner.com



www.suhner.com



Cover photo courtesy of Star SU.

# New shaping head creates more possibilities.

## Performance and precision with electronic helical guide.

The compact shaping head SKE 120 for the shaping machines LSE 200 – 1600 increases production flexibility. Without changing the shaping guide, this shaping head version is able to machine a large variety of different parts.

- Controlled lead guide for spur and helical gears
- Stroke adjustment range 650 mm
- Shaping spindle with hydrostatic bearings and guide
- Option of helix angle corrections
- Easy workpiece change and short setup times
- 1200 double strokes per minute
- Gears up to module 8 mm
- Stroke length 120 mm



Liebherr Gear Technology, Inc.  
1465 Woodland Drive  
Saline, Michigan 48176-1259  
Phone.: +1 734 429 72 25  
E-mail: info.lgt@liebherr.com  
[www.liebherr.com](http://www.liebherr.com)

# LIEBHERR

The Group

THE GEAR INDUSTRY'S INFORMATION SOURCE

www.geartechnology.com

The Gear Technology Archive

Visit [www.geartechnology.com](http://www.geartechnology.com) to view our online archive of more than 31 years of technical content related to gear manufacturing. Articles are indexed by subject, so all you have to do is type what you're looking for into the search bar.

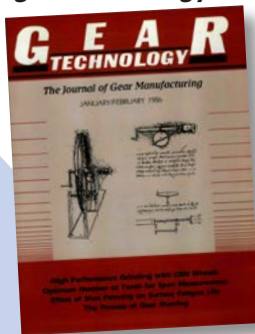

**gear**  
TECHNOLOGY

RANDALL PUBLICATIONS LLC  
1840 JARVIS AVENUE  
ELK GROVE VILLAGE, IL 60007

(847) 437-6604  
FAX: (847) 437-6618

EDITORIAL

**Publisher & Editor-in-Chief**  
Michael Goldstein  
[publisher@geartechnology.com](mailto:publisher@geartechnology.com)

**Associate Publisher & Managing Editor**  
Randy Stott  
[wrs@geartechnology.com](mailto:wrs@geartechnology.com)

**Senior Editor**  
Jack McGuinn  
[jmcguinn@geartechnology.com](mailto:jmcguinn@geartechnology.com)

**Assistant Editor**  
Erik Schmidt  
[erik@geartechnology.com](mailto:erik@geartechnology.com)

**Editorial Consultant**  
Paul R. Goldstein

**Technical Editors**  
William (Bill) Bradley, Robert Errichello,  
Octave Labath, P.E., John Lange, Joseph  
Mihelick, Charles D. Schultz, P.E., Robert  
E. Smith, Mike Tennutti, Frank Uherek

DESIGN

**Art Director**  
David Dopinski  
[dropinski@geartechnology.com](mailto:dropinski@geartechnology.com)

ADVERTISING

**Associate Publisher  
& Advertising Sales Manager**  
Dave Friedman  
[dave@geartechnology.com](mailto:dave@geartechnology.com)

**Materials Coordinator**  
Dorothy Fiandaca  
[dee@randallpublications.com](mailto:dee@randallpublications.com)

**China Sales Agent**  
Eric Wu  
Eastco Industry Co., Ltd.  
Tel: (86)(21) 52305107  
Fax: (86)(21) 52305106  
Cell: (86) 13817160576  
[eric.wu@eastcotec.com](mailto:eric.wu@eastcotec.com)

ON-LINE

**Digital Content Manager**  
Kirk Sturgulewski  
[kirk@geartechnology.com](mailto:kirk@geartechnology.com)

CIRCULATION

**Circulation Manager**  
Carol Tratar  
[subscribe@geartechnology.com](mailto:subscribe@geartechnology.com)

**Circulation Coordinator**  
Barbara Novak  
[bnovak@geartechnology.com](mailto:bnovak@geartechnology.com)











RANDALL STAFF

**President**  
Michael Goldstein  
**Accounting**  
Luann Harrold



This Month's Highlighted Topics:

Grinding  
Inspection

GRINDING	INSPECTION
 <p><b>Gear Grinding Gets Integrated at IMTS 2012</b> The latest machines, tooling and technology for gear grinding were featured at IMTS 2012....</p>	 <p><b>No Compromising on Quality at Allison Transmission</b> Gleason 350GMS helps put higher quality, more reliable gears into its next-generation TC10 automatic....</p>
 <p><b>Effects of Gear Surface Parameters on Flank Wear</b> January/February 2009 J.C. Wang, Dr. Jay Chakraborty, Hai Xia</p>	 <p><b>Better Gears &amp; Splines With Metrology</b> July 2007 Brian Stone</p>
 <p><b>Innovative Concepts for Grinding Wind Power Energy Gears</b> June 2009 A. Tuzsch, C. Kobalika, D. Vucetic</p>	 <p><b>Gear Failure Analysis Involving Grinding Burn</b> January/February 2009 Gregory Blake, Michael Margetta, Wilson Silverthorne</p>
 <p><b>Grinding Gears for Racing Transmissions</b> September/October 2009</p>	 <p><b>Practical Magic - Metrology Products Keep Pace with Machine Technology</b> July 2009 Matthew Jaster</p>
 <p><b>Grinding Induced Changes in Residual Stresses of Carburized Gears</b> March/April 2009 R. LeMaster, B. Boggs, J. Bunn, C. Hubbard and T. Watkins</p>	 <p><b>Extending the Benefits of Elemental Gear Inspection</b> July 2009 Irvyng Leikin</p>

New in the Buyers Guide



Stay Connected



Follow us on Twitter  
[twitter.com/#!/Gear\\_Technology](https://twitter.com/Gear_Technology)



Connect with us on LinkedIn  
[www.linkedin.com/groups/Gear-Technology-Magazine-3893880](http://www.linkedin.com/groups/Gear-Technology-Magazine-3893880)



Subscribe Online  
[www.geartechnology.com/subscribe.htm](http://www.geartechnology.com/subscribe.htm)



# For the Last 60 Years, We've Never Stopped Learning

Searching for a higher gear-producing IQ? Make the smart choice today.

Your trusted source for



**FOREST CITY GEAR**

11715 Main Street, Roscoe, IL 61073  
815-623-2168  
[www.forestcitygear.com](http://www.forestcitygear.com)

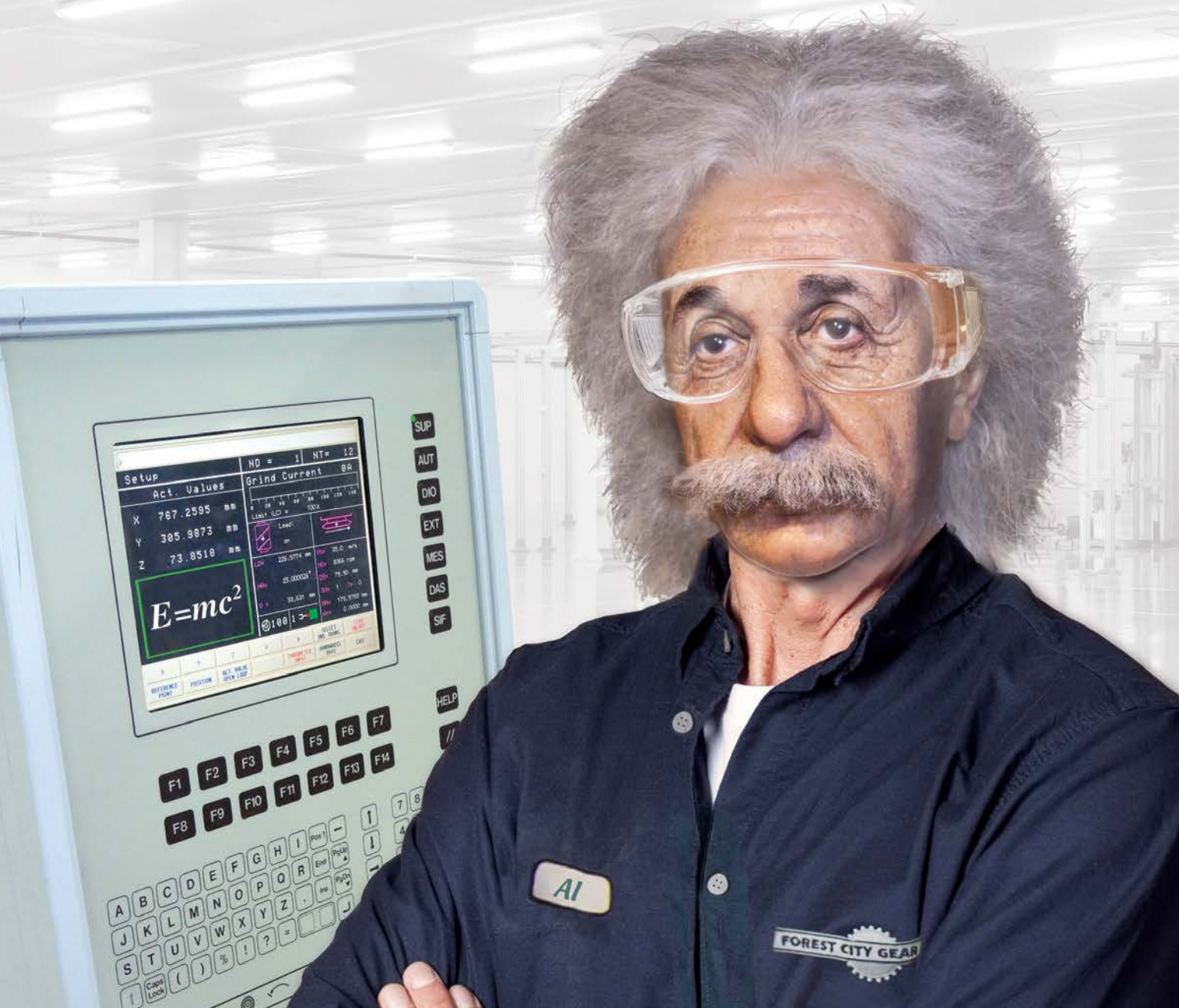



**MITSUBISHI**  
HEAVY INDUSTRIES AMERICA, INC.

Our Technologies, Your Tomorrow

# The Efficiency of Process Integration



ZE40A  
**PROCESS+**integration

## Maximize Production and Profits With Mitsubishi's Multiple Process Capabilities Machines.

When you reduce steps you reduce costs. With that in mind Mitsubishi developed its Process Integration platform. It allows various operations, such as chamfering, deburring, inspection, timing and meshing, to be incorporated into our existing gear machines. The advantage is clear. It's simply more efficient to have one machine completing two or more processes. With numerous options and configurations available you can customize our shaping, grinding or hobbing machines to incorporate the additional services that precisely meet your needs—and maximize your efficiencies, production and profits. To learn how you can leverage all the possibilities of Process Integration visit [www.mitsubishigearcenter.com](http://www.mitsubishigearcenter.com) or contact sales at 248-669-6136.

Inspection Device

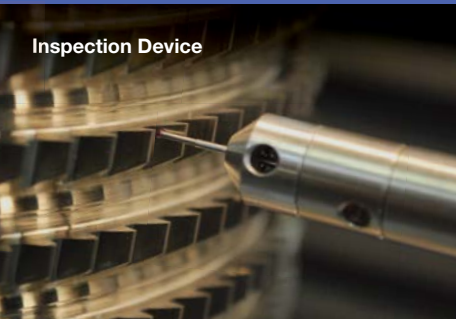

Dress



Automation

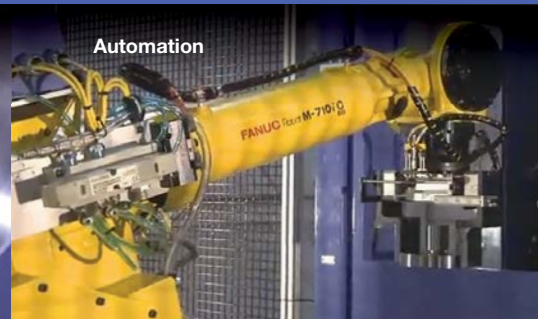

# Good Morning, Class

Since we began publishing in 1984, *Gear Technology's* mission has been to educate our readers. For 31 years, we've shown you the basics of gear manufacturing as well as the cutting edge. We take our educational mission quite seriously, and we go through steps that most publishers don't have time for or wouldn't consider.

For example, most of the technical content in our magazine is reviewed by experts before you see it. We rely on some of the best minds in gear manufacturing—professionals with many decades of experience solving the types of problems you face every day—to help ensure that our articles are accurate, up-to-date and as free from commercial bias as possible (in other words, educational).

So it should be no surprise that we've brought on a couple of top-notch *teachers* as the newest technical editors for the magazine. Both have a wealth of experience teaching gear manufacturers how to make better gears, how to make them more productively and how to understand the nuances of the different manufacturing processes. Many of you have taken their classes or attended their presentations and may be familiar with their expertise.

But for the rest of you, I'm proud to introduce John Lange and Michael Tennutti as the newest technical editors for *Gear Technology*.

Lange began his gear industry career in 1970 with Miller Associated, the North American sales representative for the Maag Gear Wheel Company. From 1971 until 1986, Lange was a gear manufacturing process engineer specializing in Maag cutting, grinding and inspection equipment, as well as Lorenz gear shaping machines. In 1986, Lange joined American Pfauter and began his association with the Pfauter-Maag Gear Cutting School. Gleason acquired the Pfauter Group in 1997, and Lange has been affiliated with Gleason educational programs ever since. In about 1996, he began conducting 3-day cylindrical gear manufacturing seminars in customer plants. He estimates that he's held several hundred of these classes all around the world. Although he retired from Gleason in 2014, Lange is still active with the Gleason gear school and continues to conduct these seminars. He served as chairman of AGMA's Gear Manufacturing Committee for four years and AGMA's Metrification Committee for three years. He's presented numerous technical papers at AGMA and ASME conferences, wrote two chapters for the SAE *Gear Handbook* and has written several articles for *Gear Technology*.

Michael Tennutti has more than 50 years' experience in the cutting tool and gear industry, and he's widely acknowledged as a leading expert in the design and application of gear cutting tools. He's been an instructor for both Gleason Cutting Tools and the AGMA Gear School. He holds two patents—one on hob construction and one on an inserted-blade cutter assembly. He's been involved with the AGMA technical committees for close to 20 years and is the recipient of an AGMA Technical Division Executive Committee Award.



**Publisher & Editor-in-Chief**  
Michael Goldstein

As technical editors for *Gear Tehcnology*, Lange and Tennutti join some of the giants of our industry: Bill Bradley, a recipient of AGMA's lifetime achievement award, who oversaw standards development and served as the chief American liaison to ISO as VP of the AGMA Technical Division; Bob Errichello, recipient of AGMA's lifetime achievement award, whose AGMA Gear Failure Analysis seminar is perennially sold out; Octave Labath, independent consultant who has served on a number of AGMA technical committees and is a recipient of the AGMA TDEC Award; Joseph Mihelick, former member of the AGMA Board of Directors and recipient of the AGMA Board of Directors Award; Chuck Schultz, *Gear Technology's* resident blogger and author of *An Introduction to Gear Design*; Bob Smith, gear inspection expert, longtime employee of the Gleason Works and recipient of numerous AGMA awards, including the Edward P. Connell Award and the TDEC Award; and Frank Uherek, principal gear engineer for Rexnord and recipient of the AGMA Distinguished Service Award.

The brief description given here doesn't do justice to the distinguished careers of these gentlemen. These technical experts have contributed much to our industry.

The fact that we have these experts available to us, and that we use them to inform the content of our magazine, sets us apart from other publishers. They volunteer to help us make our work better. I should point out that they don't do it for the recognition. To a man, they do so because they want to give back to the industry that has supported them. They believe—like we do—that a more educated gear manufacturing community is a far stronger one.

But kudos are well-deserved. So I'd like to take this opportunity to thank all of our technical editors for their support and help in making *Gear Technology* the finest technical publication in the world. We couldn't do it without them.

P.S. One of the best ways for you to show your appreciation is to renew your subscription to *Gear Technology*. Just go to [www.geartechnology.com/subscribe.htm](http://www.geartechnology.com/subscribe.htm). It's FAST, EASY and FREE. You'll be doing us a big favor, and you'll continue to receive *Gear Technology* for another two years.

# Less Manual, More Modular Workholding for Gears

BY TIM ZENOSKI, DIRECTOR, PRODUCT MANAGEMENT WORKHOLDING, THE GLEASON WORKS

*A new generation of modular, quick-change workholding systems requiring fewer tools, less time and minimal operator experience for workpiece changeover has arrived.*

In recent years, gear manufacturers have made enormous strides in reducing cycle times with highly productive new machine and cutting tool technologies. At Gleason, taking cost out of every gear production process doesn't end there. We've long believed that workholding is as important as any other manufacturing component. This has never been more true than in today's just-in-time manufacturing environments. In the past, a volume manufacturer might have purchased a machine dedicated to producing just a single part number throughout the life of the machine. Part changeover requirements were infrequent, if not altogether non-existent. But today,



The operator installs a new Quick-Flex Plus module onto the common workholding interface.

many manufacturers are meeting fast-changing customer demand and marketplace conditions with production of much smaller batch sizes — requiring more frequent part changeover. Setting up a machine to run a new part number quickly, easily and with greater repeatability isn't a once- or twice-a-year thing — it's likely happening several times a day.

**Time is money, and even seconds count.** Preparing a traditional workholding assembly for the production of a new part can typically take anywhere from 20 to 30 minutes and require a high level of operator expertise. First, the machine operator must remove the existing tooling from the work spindle — piece by piece, bolt by bolt, all the while leaning awkwardly into the work envelope and making sure not to drop slippery wrenches and fasteners. Then, with installation of the new assembly, the process gets even slower, more tedious and more operator-intensive.

All the components of the new assembly must of course be perfectly clean and properly lubricated. Even minimal dirt or residual swarf can ultimately cause unacceptable runout in the arbor. And improper lubrication can lead to fretting corrosion, and the potential for parts to seize up and/or fail catastrophically.

Most importantly, the operator must be well-versed in the steps needed to ensure that standard workholding accuracies and repeatability are met — typically  $\pm 0.005$  mm (0.0002") total indicator reading. Arbor body, collet, expander, backing ring — all must be checked and 'trued' as

they're assembled, using indicator gauges. Precise torque specifications must also be observed when tightening arbor body bolts and other fasteners. Repeat this process two or three times over the course of the average workday, and the manufacturer can lose an hour or two of precious spindle time, and hundreds, perhaps thousands of dollars in lost productivity each and every week.

**Making the change from manual to modular.** For those manufacturers unwilling to accept the status quo, there's a completely new technology available that takes most of the time, operator experience, and accuracy variables out of the changeover process. Gleason's modular workholding systems greatly reduce system complexity and, concurrently, most of the time and operator experience required for assembling traditional workholding systems. The best recent example is the new Quik-Flex Plus system for machines producing cylindrical gears that range in size from very small, fine pitch gears to those with diameters as large as 600 mm. Quik-Flex Plus is an improved version of the Gleason Quik-Flex system now in use globally on hundreds of Gleason and non-Gleason machines. With Quik-Flex Plus, even the novice machine operator can change over the workholding for one part type to another in under a minute. Here's how it works:

One of three standard base units (small, medium or large) is mounted to the machine's work spindle during a one-time installation. It's easily 'trued' to zero axial and radial runout and permanently locked in place with torque

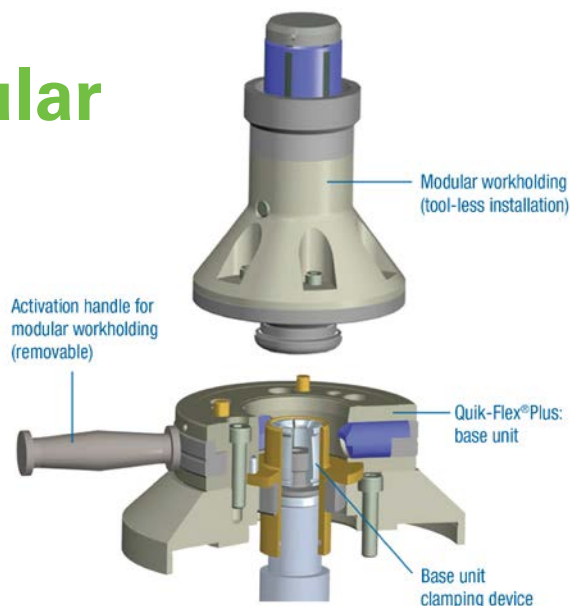



# HIGHEST QUALITY

LEADER IN GROUND TOOTH SPIRAL BEVEL GEARS

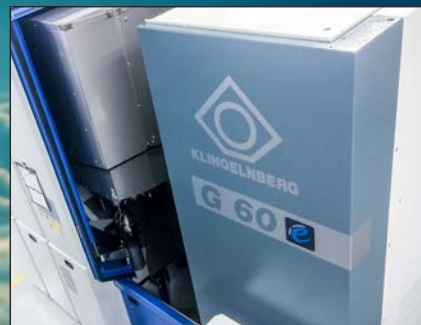

OUR BRAND-NEW, STATE-OF-THE-ART FACILITY IS AS9100 CERTIFIED, PRODUCING THE HIGHEST QUALITY SPIRAL BEVEL, HYPOID, SPUR, AND HELICAL GEARS.

OUR CLOSED-LOOP SYSTEM, COUPLED WITH OUR GRIND-FROM-SOLID TECHNOLOGY, ENSURE CONSISTENT QUALITY AND QUICK TURNAROUND.

# FASTEST DELIVERY

SPIRAL BEVEL AND HYPOID GEARS FROM DESIGN TO DOORSTEP IN AS LITTLE AS FIVE WEEKS.



**RAVE** GEARS  
AND  
MACHINING  
TALENT AND TECHNOLOGY DRIVEN



+1 855 RAV GEAR  
sales@ravegears.com  
[WWW.RAVEGEARS.COM](http://WWW.RAVEGEARS.COM)

425 STREMPER ST., SEGUIN, TX 78155

mounting bolts, essentially making it part of the spindle. Note that the new base unit has been designed both for compactness and to exceed the stiffness requirements for operations that exert significant machining forces, such as deburring and chamfering. (This is in recognition of the increasingly common practice of integrating these processes into a single machine performing multiple operations.) While the base units are designed for Gleason machine spindle specifications, intermediate

plates are available that can match the different bolt patterns found on non-Gleason work spindles. This, along with potentially some minor modifications to accommodate different draw rod heights and/or stroke lengths, enable Quik-Flex Plus to be applied to a very wide range of cylindrical gear production machines.

The operator next installs the only other component required — an expanding collet (typically for gear bore applications) or a contracting collet (for pinion shaft applications), which is a part-spe-



cific module. The operator simply lowers it onto the base unit, fitting the module's retention knob over the base unit's gripper fingers and rotating the module just enough so that three internal clamp lugs in the base unit are aligned. Finally, the installation is completed by turning the removable activation handle clockwise, which causes internal clamp lugs in the base to engage with the module's retention knob, pulling the module down and precisely centering it with the taper built into the tooling. The gripper fingers pull down to securely lock the module in place, and the handle (spring-activated to prevent the handle from being inadvertently left in the machine) is removed. A gear or pinion blank (or line gage) is hand loaded, and then chucked/de-chucked to fully seat the module. The entire process can take as little as 30 seconds.

Because of the popularity and widespread use of Quik-Flex Plus' predecessor — Quik-Flex — provisions have been made as well to make it simple and economical for current Quik-Flex users to continue to use their existing modules. A simple adapter base, available in three sizes, can be retrofitted to an existing module, thus enabling the module to fit onto a new Quik-Flex Plus base.

Quik-Flex is a registered trademark of the Gleason Works.

**For more information:**

The Gleason Works  
1000 University Avenue  
P.O. Box 22970  
Rochester, NY 14692-2970  
[www.gleason.com](http://www.gleason.com)



## AUTOMATED GRINDING OF GEAR SHAFTS AND BORES

LOAD, GRIND, MEASURE, PERFECT AND REPEAT.

With cutting-edge cylindrical grinders that increase performance, enhance efficiency and generate cost-effective processes, whatever "GEAR" you're in, turn to [Weldon Solutions](http://WeldonSolutions.com).



Visit us at GearExpo 2015! **Booth# 2307**

OCTOBER 20-22, 2015 DETROIT, MI COBO CENTER



QUALITY. Over and over again.

[www.weldonsolutions.com](http://www.weldonsolutions.com)



# DO YOU REALLY KNOW

The Hardinge Grinding Group consists of six brands of products offering you the following grinding solutions:

- Universal OD / ID
- Surface, Profile & Creep feed
- Production OD / ID
- CNC Jig



## HARDINGE GRINDING GROUP

KELLENBERGER • JONES & SHIPMAN  
HAUSER • TSCHUDIN • USACH • VOUMARD

[www.HardingeGrindingGroup.com](http://www.HardingeGrindingGroup.com) • 800-843-8801

# KISSsoft

## ADDS FLANK FRACTURE CALCULATION TO LATEST RELEASE

The flank fracture calculation according to ISO/DTR 19042 was recently added to the latest KISSsoft release 03/2015 (module ZZ4). This type of damage manifests itself as crack formation at greater material depths. It can occur on both cylindrical gears and bevel gears. In the majority of cases, flank fracture causes the gear unit to fail completely.

The ISO Committee is currently working on the ISO/DTR 19042 calculation standard for cylindrical gears. This standard includes a method for performing the calculation with simplified load assumptions (Method B) and a local process, which makes it possible to analyze the risk of damage across the entire meshing (Method A). In the new

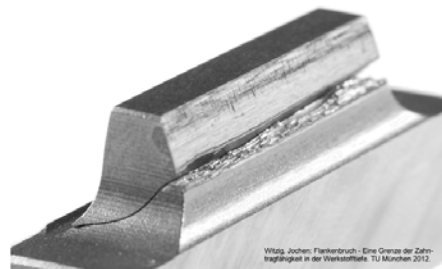

KISSsoft Release 03/2015, both methods are available to users.

**For more information:**  
KISSsoft AG  
Phone: +41 55 254 20 50  
[www.KISSsoft.AG](http://www.KISSsoft.AG)

WHEN YOU NEED IT RIGHT  
THE FIRST TIME

# The Broach MASTERS

**Much More Than Just a Broach Company!**

## & Universal Gear

The quality and precision of our Broaches, Shaper Cutters and Gears have won customers world-wide - from the smallest gear shop to NASA and the Mars Rover.

- Broach & Shaper Cutter manufacturing & repair
- Gear & Spline—prototype to production
- Master Gears & Gages
- Small & fine pitch

**Precision. Performance. Perfection. The First time and every time.**

**The Broach Masters, Inc.**  
QUALITY TOOLS SERVICE "DEDICATED TO EXCELLENCE"

1605 Industrial Drive  
Auburn, CA 95603  
Phone: (530) 885-1939  
Fax: (530) 885-8157  
Web: [www.broachmasters.com](http://www.broachmasters.com)  
Email: [info@broachmasters.com](mailto:info@broachmasters.com)

**U.G.C. MADE IN U.S.A.**

# Santasalo

## LAUNCHES QUATRO+ PLANETARY GEARS

Santasalo recently introduced its new series of planetary gear units to the global industrial market. The new Quatro+ range offers higher torques without the requirement to increase the gear unit size or weight. In addition, an extended bearing life up to 200% higher than the original Quatro series, ensures enhanced availability of the gears and reduced operating costs.

The Quatro+ series offers nominal output torque up to 1,427 kNm, up to 30% increase on the torque of the original Quatro series but with no change to the size and weight of the gear unit. Its design can be highly customized to meet the requirements of applications in many industries.



Santasalo showcased the Quatro+, for the first time, at the 2015 Hannover Fair in Germany in April. Experts on the Santasalo planetary product range were there to represent the product launch and provide experience and knowledge on both the Quatro+ and all other planetary gears offered by the business.

“Upgrading the power rating of Santasalo’s original Quatro series has





# Gear Grinding in Swiss Precision

Since Reishauer Switzerland invented Continuous Generating Gear Grinding, we have constantly been pushing the performance of our machines to new heights: Higher productivity – higher accuracy. That's why the leading automotive companies rely on Reishauer.



## Reishauer AG

Zürich / Switzerland  
+41 44 832 22 11  
info@reishauer.com  
www.reishauer.com

## Reishauer Corporation

Elgin IL / USA  
+1 847 888 38 28  
usa@reishauer.com  
www.reishauer.com

# REISHAUER

Gear Grinding Technology

allowed us to provide our customers with a new range of drives that fulfill the most demanding high torque application



needs,” said Pasi Jokela, senior vice president of Santasalo Capital Sales. “With the Quatro + series, we can deliver very cost competitive drive solutions for, not only new machines, but as a replacement of existing Santasalo Quatro drives and competitor gear units. We are excited to launch this advanced technology to the global market for heavy duty planetary gear units.”

**For more information:**

Santasalo Gears Oy  
Phone: +358 293 401000  
[www.santasalo.com](http://www.santasalo.com)

**NACHI**

**Products for the  
Aircraft  
Manufacturing  
Industry**



**Christmas Tree Forms Broach**

Create highly accurate form on turbine rotor disk blade of aircraft, ships and generators.

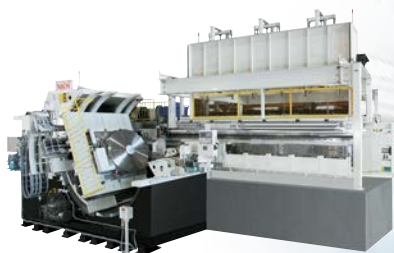
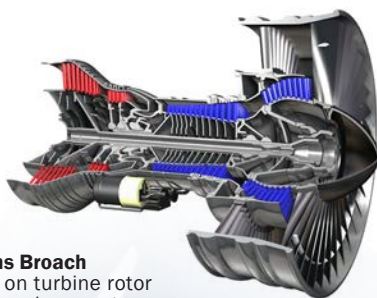

**Surface Broaching Machine**

High performance and speed production of gas turbine rotors.

**Gear Tools Division**

Visit Our New Production Facilities ~  
717 Pushville Rd.  
Greenwood, IN 46143

**Dave Petrimoulx**

586-764-2263

[dpetrimoulx@nachi-america.com](mailto:dpetrimoulx@nachi-america.com)

[www.nachi-america.com](http://www.nachi-america.com)

**Kwik Mark**

**RELEASES PORTABLE  
HANDHELD DOT PEEN  
MARKING SYSTEM**

The Micro Mark portable dot peen marker from Kwik Mark Inc. features a compact (3" x 5" x 6") head size, and a 1.0" x 2.5" marking field to suit most industrial marking applications.

Additional I/O streamlines “hand-shaking” with other machinery when required, and allows importing data from external files. The Micro Mark features automatic line centering to your



part whether it is single or multiple lines, graphics or both with no measuring or operator input required. It is designed for marking around parts such as shafts and pipes.

**For more information:**

Kwik Mark Marking Systems Inc.  
Phone: (815) 363-8268  
[www.kwikmark.com](http://www.kwikmark.com)

# Heidenhain

## INTRODUCES LATEST SOLUTION FOR HEAVY MACHINING

With the advent of Heidenhain's "Dynamic Efficiency" control features, heavy machining solutions that provide new comprehensive process management tools are now readily available through their use in Heidenhain's TNC 640 and iTNC 530 controls.

More specifically, with the concept of Dynamic Efficiency, Heidenhain offers TNC functions that improve efficiency in heavy machining by providing solutions that remove as much material in the shortest amount of time. The goal is to optimize metal removal rates, maximize tool service life and minimize the machine load.



To do this, Dynamic Efficiency comprises these three TNC control functions:

ACC (Active Chatter Control) — this option reduces chatter tendencies and permits greater infeeds; AFC (Adaptive Feed Control) — this option controls the feed rate depending on the machining situation; Trochoidal milling — cycle for the roughing of slots and pockets in a way that eases the load on the tool and the machine.

**For more information:**  
Heidenhain Corporation  
Phone: (877) 920-2703  
[www.heidenhain.us](http://www.heidenhain.us)

A large photograph of a gear being machined on a lathe. The gear is in the foreground, and the background is blurred with bokeh lights. Below the main image, there are four circular insets, each showing a different type of gear: a spur gear, a helical gear, a worm gear, and a bevel gear. The entire advertisement is set against a dark background with a blue footer.

### Gearing your past to power your future.

#### Breakdown Services

We understand the urgency of meeting critical deadlines. We offer our customers expedited services without sacrificing quality.

#### Heat Treatment

Our in-house heat treat facility performs a full range of services that include annealing, carburizing, and thru hardening.

B&R Machine and Gear Corporation is a full service gear manufacturing facility driven to power your equipment with reliable and durable gears that are built to perform and last. Find the perfect mesh. No matter the gear, we've got you covered.

VISIT OUR WEBSITE [BRGEAR.COM](http://BRGEAR.COM) FOR MORE INFORMATION

# Stotz

REPORTS NEW TECHNOLOGIES NOW AVAILABLE TO CONSERVE 40% OR MORE IN DIRECT COSTS

Air gages are typically not in use approximately 90% or more of the time they're in a shop or QC department. Because these gages function through the utilization of clean and dry compressed air in a high controlled flow, this relatively expensive commodity can cost operations unnecessarily when not in use.

It would be impractical and inefficient to turn off the unit when not in use, as doing so would require an extended period of time to restart, balance and stabilize the measurement to achieve the desired accuracies. Since air gaging, by definition, requires the precise measurement of the air flow across the surface of the part



being evaluated, this stabilization in the air flow is critical to running an efficient department and maintaining the proper protocol in measuring procedures.

Technology from is now available and allows users to connect the air column to a digital I/O regulator switch in order to turn down the air flow when the unit is not in use. The air flow can be restricted by as much as 90%, but still flows at a consistent and measured level. By doing so, you can guarantee that the measurements taken when the air returns to full flow will be accurate and repeatable. Meanwhile, the energy savings are substantial.

Such technology, to be optimally beneficial to a shop, must have the proper interface between the column and the power supply to function effectively. In one configuration, a proximity switch is positioned in the gage holder and the air flow can be triggered when the gage is removed from the holder.

Another means of arranging this type of controlled but not entirely restricted air flow is to use a pushbutton actuator on the face of the column control panel, or a foot pedal actuation could be possible.

While it is difficult to calculate the exact cost savings to a shop, owing to the various factors of on-time utilization and local energy costs, the fact remains that, in most shops, air is blowing as much as 95% of the time without being used for gaging. If your compressors don't need to run, in order to produce this unused air flow, the savings can be quite substantial. On average, a 40% or better savings in direct energy costs per compressor would not be unreasonable to expect.

**For more information:**  
Advanced Machine & Engineering Co.  
Phone: (815) 316-5277  
[www.ame.com](http://www.ame.com)



# Powered by precision

## 3M™ Abrasives for Powertrain Components

3M offers one of the world's most extensive portfolios of precision abrasives for grinding and finishing powertrain components – all engineered to take you to the next level of precision and productivity.

Gear up with high-performance 3M abrasives for applications including:

- Gear grinding
- Camshaft and crankshaft grinding
- Cylindrical grinding
- Centerless grinding
- Microfinishing
- Dressing and truing



**NEW! Driven by Innovation**



A 16-page brochure devoted exclusively to grinding and finishing powertrain components. To receive your free copy – and to find additional information on 3M abrasives for powertrain components, visit:

[www.3M.com/PrecisionGTAug](http://www.3M.com/PrecisionGTAug)



© 3M 2014. 3M is a trademark of 3M Company. Used under license by 3M subsidiaries and affiliates.



ARROW  
GEAR  
COMPANY



ARROW  
VISION

SEE IT IN YOUR RESULTS

ARROW GEAR'S  
AEROSPACE  
ADVANTAGE

FOR CARS THAT FLY

In the high-stakes world of auto racing, the difference between winning and losing is measured in milliseconds. Just a small improvement in efficiency, can mean the difference between first and second place.

At Arrow Gear, we apply the same precision used in Aerospace to produce top quality bevel gears for race car transmissions. Our Advanced Design Assistance, precision machining at every phase of production and meticulous inspection provide a winning combination for both Indy Racing League and NASCAR cars. It's the driving force that has helped Arrow Gear make a name for itself in auto racing.

**See it in Your Results.**

Call 630-969-7640 or visit [arrowgear.com](http://arrowgear.com)

# Gear Grinding is Getting Easier, Better, Faster, Stronger

Erik Schmidt, Assistant Editor

**Liebherr is well-known as one of the world's largest privately owned companies—a titan in heavy industry specializing in cranes, trucks and mammoth earth moving and mining equipment.** But Andreas Mehr, grinding and shaping technology developer and consultant at Liebherr Verzahntechnik, GmbH, Kempten, Germany, is one of the world's leading experts in a much smaller area of focus:

## Gears.

The grinding of them, to be exact.

And despite the rather minute scale of a cylindrical gear in comparison to, say, the LTM 11200-9.1, Liebherr's nine-axle mobile crane with a 100 m (328 ft.) telescopic boom, their importance in Liebherr's overall productivity is no small matter.

Quite simply: no gears, no Liebherr.

Recently, *Gear Technology* met with Dr. Mehr at Liebherr Gear Technology, Saline, MI, where he spoke of Liebherr's cutting-edge, state-of-the-art grinding processes to make gears quieter, stronger and more efficient.

## Bring (Down) the Noise

When talking with gear experts like Mehr, Gleason's Dr. Hermann J. Stadtfeld and Dr. Antoine Türich, or David Goodfellow and Mark Ritchie from Star-SU, the main questions they pose when it comes to gear grinding are clear.

"Our customers—automotive, truck transmission, tractors, and also industrial gears—we see the upcoming question: How do you improve the power density per unit?" Mehr says.

"The other thing that customers ask is what possibility do you have to decrease



gear noise? This is especially big in the automotive section, but it's also coming up in the industrial section because if you have a transmission in an escalator it should move nice and quiet. Also transportation systems in production facilities should move without noise. At the moment, these are the two big questions of our customers."

In other words: How do we make gears stronger and quieter?

In terms of advancements with machinery, Liebherr recently introduced the LGG 180 for profile and generating grinding. According to a recent press release, the machine combines short grinding times with consistent high large-scale production quality, thanks to a one-table design and a new-design grinding head. The advantage to the one-table solution is higher quality throughout the entire production. Every machined part is manufactured under the same conditions for the highest reproducibility. The one-table approach provides the statistical capability and reliability in continuously producing controlled  $\mu$ -range finish quality.

The new grinding head allows for rotation speeds up to 10,000 RPM and has spindle power of 35 kW. Given this performance data, the head enables high cutting speeds and high feed rates. The new grinding machine can exploit the considerable potential of the innovative abrasive 3M Cubitron II, the press release said.

But then again, none of that information is necessarily going to stop the presses.

What is groundbreaking, front page material, however, are the processes and the math Liebherr is utilizing to get the most out of its LGG machines.

"We can now do these noise excitation optimized modifications — NEO modifications," Mehr says. "That means we create a defined waviness to reduce noise in a high-frequency whining noise. These modifications are not new. You can make them on the old Maag gear grinders, where they do generate grinding with indexing in a single flank contact. But these machines have completely gone away from the market.

"Now, Liebherr developed the mathematics and the machine dressing and machine movements to bring this cor-

rection possibility into the continuous generating grinding process. That was the trick — and that is absolutely brand new.

Maag machines, which were prominent in the 1970s and 80s, have all but vanished from the market in present times as modern machines have gotten faster and more efficient.

"There are still a few old ones kicking around, but they are tremendously slow," says Scott Yoders, Liebherr's vice president of sales. "The cycle times are like one hour — I'm sorry, one day — for a

part. But [when it comes to NEO modifications] it's the same principle."

Instead of letting a possibly groundbreaking innovation die with the old Maags, Liebherr dusted off the decades old process developed by its very own Dr. Gerd Sulzer and applied it to cutting-edge technology.

And what they discovered was a revelation to modern generating gear grinding.

The situation is that we can now apply [the NEO modifications] to generating

## When You Have Only One Shot At Rotary Accuracy, Make It Count!



### Manual Low-Profile Circle Divider

Basic A.G. Davis CIRCLE DIVIDER™ features standard indexing of 360° or 720° positions. Round or square face plates with diameters up to 48". Patented fail-safe lock. Automatic systems available. 36/72 position economy model also available.

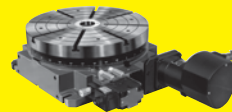

### Ball Bearing Rotary Table

Angular contact, double row, preloaded ball bearings provide the optimum combination of accuracy, stiffness and low friction. Digital readout-radial runout to .000005".



### 5-Axis CMM

The 5-axes computer controlled special coordinate measuring machine has four air bearing precision linear motions and an air bearing rotary table. Laser measurement incorporating a unique path layout and environmental monitoring compensates for pitch and sag. Air bearing electronic probes contact the part contour. The total system accuracy is .0000050" within the envelope of travel.



### Two-Axis Servo/Rate Rotary System

Vertical 16" faceplate dia. table and horizontal 9" dia. air bearing table with integral motor drive and precision encoder.



### Astro Guidance Test Platform

References the north star three axis (Ultradex) index system. System accuracy 0.3 arc second band, PC based control, IEEE-488 interface.



### Air Bearing Rotary Table

The ultimate precision rotary table for CMM and other high accuracy applications. Radial runout to .000001 T.I.R. Can be used vertical or horizontal. Servo or standard motor drives.



### Automatic NC Precision Trunnion

4th & 5th axis machining capabilities. Three available grades of angular accuracy on both the rotational axis and tilting axis:  $\pm 3$  arc second,  $\pm 2$  arc second, and  $\pm 0.25$  arc second. Face plate platens from 350 mm to 630 mm. Larger sizes available upon request.



### 50 inch Precision Centrifuge

- Accelerometer Testing
- Constant "G" within (+/- 0.01%)
- 32 Slipring Channels
- 0.2 to 200 "G" Range
- Outputs for rate sensing
- IEEE - 488 Interface

Inspection  
Radial Milling  
Calibration  
Calibration Services  
Index Position  
Contouring  
Circle Division  
4th - & 5th Axis  
Machining



Contact us direct or visit our website  
**A.G. Davis - AA Gage**

Telephone: 586-977-9000 • Fax: 586-977-9190  
www.agdavis.com e-mail: [agdavis@agdavis.com](mailto:agdavis@agdavis.com)

grinding, says Yoders. “And that is really state of the art.”

### Idle Time is the Devil's Workshop

Türich, vice president of product management - grinding solutions, of Gleason Corporation (Rochester, NY), has also been working on conquering his own burdensome list of gear grinding problems. One of which, like Liebherr, has been noise reduction.

“We have a slogan — which is a bad slogan — but we say, ‘Singing gears are happy gears,’” Türich says. “But nobody wants to hear the gears in the gearbox because it’s a terrible noise. So noise issues are an important factor.”

Another concern, though, is shortening grinding time, a point that brought the conversation tangentially back to both Cubitron II and Liebherr.

“To speed up the process is a never-ending story,” Türich says. “Every time we think, ‘Wow, this must be the pinnacle,’ someone else is coming on the market with a new grinding material and you can once again increase your productivity.

“One important point here is the grinding material Cubitron II, and I’m quite sure [Mehr] over at Liebherr also told you about it, because they are heavily advertising this technology as well — and they are right, it’s really something that is maybe a game changer.”

But grinding time, according to Tuerich, isn’t the only thing that matters.

“It’s not everything,” he says, “because at the end what counts is the cycle time. You also have to add non-productive idle time, which is loading and unloading. If you’re doing gear grinding, you have to index your parts in order to mesh them together with the grinding wheel. If you can grind faster and faster but you’re not working on your idle time, then your idle time, in proportion, will get higher and higher. This is something that customers don’t like.

“This is something that we’ve recently worked on. Our latest development is a new grinding machine called 200GX, which is a new double-spindle grinding machine. There are two work spindles, and on one spindle we are doing the grinding cycle, while on the second

spindle — it’s the non-productive spindle — we are exchanging the workpieces and clamping and indexing the workpieces, to minimize the idle time.

“This is our latest machine development, although I should say this is nothing really new to the market since there is already some competition on the market for a couple of years.”

Among those competitors are Reishauer, which introduced their double-spindle concept several years ago, and Star-SU LLC (Hoffman Estates, IL), a company that prides itself on the uniqueness of its gear grinding machines and its ability to consistently produce products “equal or better” than anything else on the market, according to president David Goodfellow.

“We have a lot of gear grinding equipment in both the horizontal and vertical environment,” says Mark Ritchie, Star-SU’s vice president of sales - engineering. “Right now we’re promoting the G 250, which is our vertical twin-table machine, which is capable of being converted into a single table machine up to 450 mm parts. In conjunction with our

## EXCEL-LENCE AT WORK

# EXCEL CNC RETROFITS – SMART MOVE!

**Your best investment.** We’re now restoring outdated gear machines to like-new condition – and saving our customers thousands of dollars vs. a new machine purchase. With our exceptional engineering and in-house machining and grinding capabilities, EXCEL is the ‘perfect fit’ for CNC retrofits.

*Circa '80s shaper and hobber recently retrofit with powerful new FANUC CNC for a major aerospace manufacturer.*



**Ready to Excel? Contact:**



**A DIVISION OF EXCEL GEAR**

**815.270.1004 / [www.excelgear.com](http://www.excelgear.com)**





# GoldENGINEERING

## ***Gear Up with Ingersoll!***

***Your most experienced source in the design & manufacture of ICI gear machining tools***

### ***Gear Shapers***

- Roughing at three to four times faster than conventional methods

### ***Gear Gashers***

- Custom indexable roughing & finishing cutters
- Designed to your specific tooth profile

### ***Hobbing Cutters***

- Segmented designs with angled screw holes for simple, accurate indexing
- Single, double and even triple-start designs

Member IMC Group  
**Ingersoll**  
Cutting Tools

845 South Lyford Rd · Rockford, IL 61108-2749 · 866/690-1859 · Fax: 815/387-6968 · [www.ingersoll-imc.com](http://www.ingersoll-imc.com)



ability to contour dress and bias grind we also have technology in our control that manages all transmission errors that are known to cause noise issues in a gear set. We have also developed technology that allows us to manage the surface pattern and roughness of the gear surface to further reduce the noise of the gears and increase the surface toughness.

“For us, that’s kind of a unique thing where it gives us a little bit more modularity, if you will. We’re using the same machine for various part sizes. We do have some very interesting technology that is available on the G 250 that we don’t see on a lot of our competitors. We have the ability to use threaded wheels with an outside diameter of 110-90 mm for special applications.

“We also have a spindle multiplier that we use with very small CBN wheels that allows us to do higher production, difficult-type parts up to 24,000 RPM. These are some of the unique features of the G 250.”

The G 250 machine, which debuted at EMO in 2011, is based on the established concepts of the Samputensili S

250/400 G machine—so consider it the latest evolution of a product line that has long been considered one of the industry’s standard bearers.

“The vertical machines are more orientated toward the automotive industry,” Goodfellow says. “Very high-volume production, and of course the trend today in automotive transmission boxes is going away from hob and shaved to hob and ground gears. This leads us, therefore, to the promotion of the G 250 double-spindle machine, which takes cycle time out of the machine. It can change the part very quickly and we’re grinding parts down in about 10 seconds.

“So you need to change the workpiece from the ground piece you just did to the next piece in less than two or three seconds. Otherwise, if you have a five second cycle time between workpieces, then 50% of your grinding cycle is in your workpiece changing.

“Everyone is in a fight now to take the idle time out of the grinding process. That’s the reason for the double spindles.”

## No Money for Capital Equipment Purchases? NO PROBLEM! Let Pentagear REPOWER your Gear Inspection Machines Today!

Same Basic Body... **REPOWERED** By **PENTAGEAR PRODUCTS** **New Smarter Brain!**

**We Put The Smart Stuff Inside!**

### REPOWERED BY Pentagear

- Analytical Inspection Machine
- Roll Testers
- Single Flank
- DOB Inspection Gauges
- Deburr Machines



6161 Webster St. Dayton, OH  
Tel: 937-660-8182 Sales@Pentagear.com  
Fax: 937-660-4521 www.gearinspection.com

Interestingly enough, for a company that routinely throws out the “unique” designation when speaking of its machines, Goodfellow surprisingly downplayed the notion that there’s much of a difference between what companies such as Reishauer, Kapp, Gleason, Liebherr and Star-SU are doing in terms of gear grinding.

“There’s nobody that has a super special, unique thing that is so different that nobody else can do it,” he says. “It’s always about who has the faster load-unload; whose got the more reliable machines; whose got the latest technology; whose got the best accuracy.

“I believe we are equal or better than anybody else that’s out there.”

Goodfellow paused briefly after that confident declaration, and then added:

“You also often don’t know what somebody else has got on the drawing board. But it will certainly be worth visiting us at EMO Milan to see what new technology advancements we’re coming out with.”

## Carrying the Load

Twenty-five years ago, Liebherr’s Sulzer had one of the busiest drawing boards in the industry.

Among several processes Sulzer patented while at Liebherr was one for a form of polish grinding that created a fine surface finish on cylindrical gears.

“It’s an old concept,” Mehr says. “It was from the same guy: Dr. Sulzer. He had a very creative brain. He patented the process in 1988 based on an electroplated CBN tool for roughing and finishing and a resin bonded wheel for super finishing mounted on one arbor ... nobody wants to have it. Twenty-five years running this patent, nobody asks. Now the patents are over and everybody wants to have it.

“Therefore, we had to [change the process a little bit] due to the new abrasives [on the market] — for example, roughing with Cubitron II to get a fast roughing process, then maybe we make a finishing with a finer grit size, and at the end [we use] the resin bonded, synthetic, elastical polishing worm.”

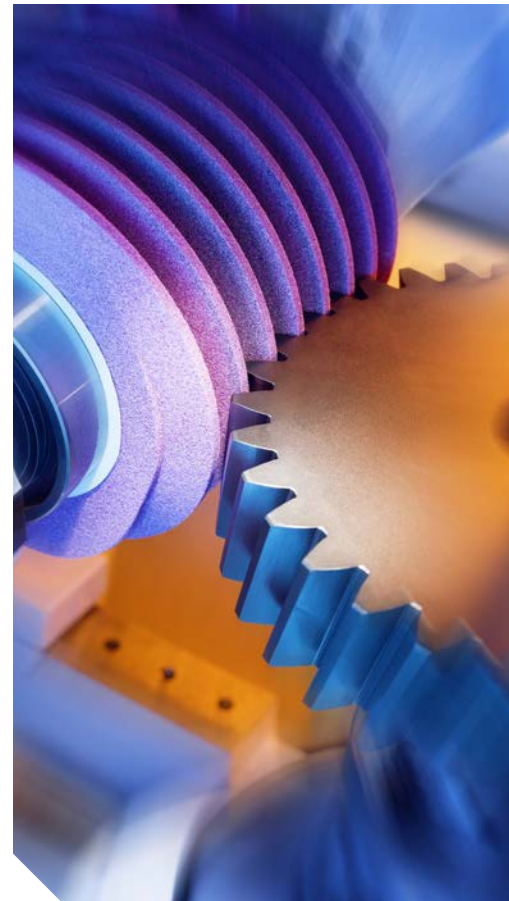

# All The Gear Cutting Tools You Will Ever Need Are Right Here

## DTR is one of the world’s largest producers.

### DTR. Your best choice for high quality gear cutting tools.

DTR is a world class supplier of the finest high performance long-life gear manufacturing tools, for small and large gear cutting applications. Established in 1976, we are one of the world’s largest producers of cutting tools, shipping to over 20 countries.

DTR offers a full line of gear cutting tools including:

- Hobs
- Carbide Hobs
- Shaper Cutters
- Milling Cutters
- Chamfering and Deburring Tools
- Broaches
- Master Gears

We can produce virtually any tool you need for auto, aerospace, wind, mining, construction and other industrial gears.

Every tool is precision-made utilizing high speed steel, premium powder metal or carbide and the latest in coatings, to achieve superior cutting and long life. DTR uses top of the line equipment including Reischauer CNC grinders and Klingelberg CNC sharpeners and inspection equipment.

Learn more about our outstanding quality tools at [www.dragon.co.kr](http://www.dragon.co.kr).

Call us at 847-375-8892 for your local sales representative or Email [alex@dragon.co.kr](mailto:alex@dragon.co.kr) for a quotation.



# DTR

PERFECTION MOVES US

(formerly Dragon Precision Tools)

[WWW.DRAGON.CO.KR](http://WWW.DRAGON.CO.KR)

**DTR has sales territories available. Call for more information.**

**U.S. Office Location (Chicago)**

**Email inquiries to:** [alex@dragon.co.kr](mailto:alex@dragon.co.kr)

1865A Hicks Road, Rolling Meadows, IL 60008

**PHONE: 847-375-8892 Fax: 224-220-1311**

**Headquarters**

36B-11L, Namdong Industrial Complex, Namdong-Gu, Incheon, Korea

**PHONE: +82.32.814.1540**

**FAX: +82.32.814.5381**

Liebherr's polish grinding process is past testing and is close to going into production, Mehr says.

According to Reishauer, polish grinding is a final machining sequence performed on a manufacturer's existing gear grinding machines that consists of one polish grinding pass with a resin bonded section joined to a vitrified bonded threaded grinding wheel, said Walter Graf, marketing manager for Reishauer AG, during a presentation on polish

grinding at the CTI Symposium held in May in Novi, MI.

According to Graf, the aim of polish grinding is a reduction in surface roughness without altering the gears' macro geometry, the gears' flank topography and the material surface structure. The polishing process has to remove the peak surface roughness, reduce the core roughness, but leave intact some of the peak valley roughness such that transmission oil films continue to adhere to the transmission gears. Because the surface rough-

ness of a polish ground gear is substantially reduced, it will cause less friction in a transmission and, consequently, would offer increased load-carrying capacity and a reduction in power loss.

"The reason for [polish grinding] is that some customers want to increase the load carry capacity on the gear flank," Mehr says. "You also can get a better efficiency out of the transmission, because you can change the transmission oil; you can make it more liquid so that the slipping wear when the gears are running through the oil can be reduced.

"It's possible, but not the biggest aim for the customer to reduce gear noise with this. It's really load carrying capacity of the asymmetric gears and the efficiency of the transmission — those are the two big aims."



#### For more information:

Gleason Corporation  
[www.gleason.com](http://www.gleason.com)

Liebherr USA  
[www.liebherr.us](http://www.liebherr.us)

Reishauer AG  
[www.reishauer.com](http://www.reishauer.com)

Star-SU LLC  
Phone: (847) 649-1450  
[www.star-su.com](http://www.star-su.com)

presrite

**PEOPLE AND TECHNOLOGY  
MAKE THE DIFFERENCE**

At Presrite, our experience, innovation and expertise ensure that you get the best net and near-net forgings. Our new Tech Center has state-of-the-art design, engineering technology and die-making capabilities.

- Dedicated state-of-the-art facility
- Presses up to 6,000 tons of capacity
- .008-.060 stock allowance on gear blanks
- ISO 9001:2008
- TS 16949:2009



[www.presrite.com](http://www.presrite.com) • 216-441-5990



[www.geartechnology.com](http://www.geartechnology.com)

# Bevel Grinding 'Rolling' Right Along

When Dr. Hermann J. Stadtfeld speaks, people tend to listen.

Considered one of the world's foremost experts on bevel gears, Stadtfeld, the vice president of bevel gear technology at Gleason, recently revealed several cutting-edge advancements that the company has been working on.

The first of which should have the industry's collective ears firmly planted to the ground.

"We came up with what we call the FormRolling process," Stadtfeld says. "It allows you to make a correction in the gear — a flank-form correction on top of the originally calculated flank-form. This particular correction allows the gear set to be as quiet as the best lapped gear set in face hobbing and the deflection forgiveness is the same or even higher than in face hobbing.

"This is brand new ... and the result is awesome."

According to Stadtfeld and Gleason Gear Process Theoretician Robert T. Donnan, the term FormRolling relates to a method which creates an end relief and which is integrated into the plunging cycle of non-generated bevel gears. This method bases on the idea that the tool after feeding to the correct final tooth forming position (in case of non-generated gears) could be swung sideways out of cutting or grinding contact with the slot instead of a withdraw path which is identical to the plunge path but

moves in the opposite direction. Such a swing motion can be conducted around an axis which is determined in three dimensional space exactly to achieve an end relief with a certain width (in face width direction), a certain magnitude of maximal relief and with a certain function (like relief build up linear, second or higher order relative to the distance from the relief begin).

After the side swing, the tool can move any path which is fast and avoids interference between part and tool in order to prepare for the next slot machining. Because the sideways swing is directly connected to the plunging process and presents the first part of the tool withdrawal, the additional time consumption is nearly negligible, according to Stadtfeld.

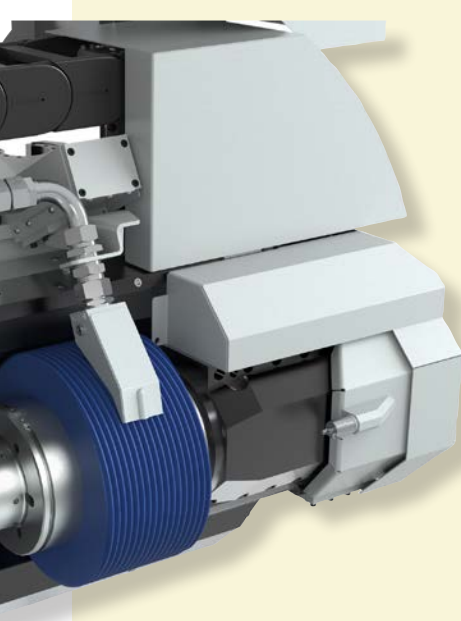

1.800.569.1420

# EXPECT MORE

Our team is committed to keeping our promises and ensuring your complete satisfaction from inquiry to delivery.

**"I'll get your quote within 4 hours."**  
*Brandy - Inside Sales Associate*

**McINNES ROLLED RINGS**

**Fast Quoting**

**Exceptional Product Quality**

**On-Time Delivery**

[McInnesRolledRings.com/ExpectMore](http://McInnesRolledRings.com/ExpectMore)

Stadtfeld summarized the recent innovation by saying that the introduced method of FormRolling to create end relief is not limited to grinding; it is also possible to apply the same swing motions in a cutting process. Within certain limits chamfers can also be generated with this correction feature. The solution of this motion concept in the established V-H setting environment does not require any changes of the common method of cutting and grinding Formate gears.

Also, the closed-loop with corrective V-H settings from G-AGE can be applied without any limitations. Secondary cuts and interferences are avoided by choosing the reference cross section for correction vector and rotation vector in the center of the relief section. The possibility to create end relief without a substantial time penalty will allow the manufacturing of ground bevel and hypoid gear sets with the same or higher insensitivity to

housing, gear and bearing deflections as it was known in the past only from face hobbed geometries, according to Stadtfeld.

“There are new elements (with FormRolling being one of them) that all independently contribute to a higher production stability and economy,” Stadtfeld says. “With these processes you can work faster and you can grind a part faster. There are several elements that when you look at them, they’re completely independent. MicroPulse is independent from FormRolling and Universal Motion is independent from MicroPulse. But you take them all together and you get the first time in history where there’s a grinding process that is more stable than it ever was.

“There is a future grinding process, and that future happens now.” 

#### For more information:

Gleason Corporation  
[www.gleason.com](http://www.gleason.com)



## HANS-JÜRGEN GEIGER

Maschinen-Vertrieb GmbH

Metzingen / Stuttgart



**High quality used machine tools  
from Germany since 1968.**

Please visit our showrooms:  
7000 sqm display area with more than  
600 machines in best condition.

**HANS-JÜRGEN GEIGER**  
Maschinen-Vertrieb GmbH  
James-Watt-Straße 12  
D-72555 Metzingen (Germany)  
Phone +49 (0) 7123 / 18040  
Fax +49 (0) 7123 / 18384  
E-Mail: [geiger@geiger-germany.com](mailto:geiger@geiger-germany.com)

[www.geiger-germany.com](http://www.geiger-germany.com)

**MIKRON**  
**DMG | DISKUS**  
**TBT | HELLER**  
**ELB | NAGEL**  
**SCHAUDT**  
**KEHREN**  
**KARSTENS**  
**MIKROSA**  
**INDEX | ZEISS**  
**BOEHRINGER**  
**GILDEMEISTER**  
**SCHÜTTE**  
**AGIE | SCHULER**

Gear cutting  
machines:

**LORENZ | HURTH**  
**PFAUTER | KAPP**  
**KOEPFER | NILES**  
**LIEBHERR**  
**REISHAUER**  
**LINDNER**  
**KLINGELBERG**  
**GLEASON**  
**WMW**



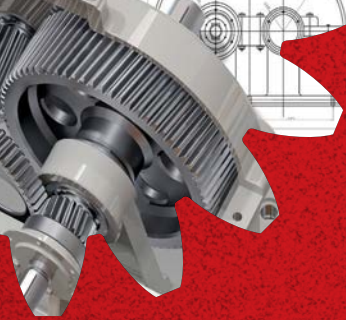

**GEAREXPO**  
**2015**  
THE DRIVE TECHNOLOGY SHOW

# POWERFUL CONNECTIONS

OCTOBER 20-22, 2015  
DETROIT, MI  
COBO CENTER

**REGISTER TODAY**  
FOR THE DRIVE TECHNOLOGY SHOW OF THE YEAR!

**GEAR EXPO 2015** brings together the full range of experts — design, manufacturing, application engineering — all in the same place — **Cobo Center, Detroit, October 20–22.**

From a single gear to complex drives, **GEAR EXPO** covers it all...

- **More exhibitors** — from gear making machines to systems integrators.
- **More education sessions** — from metallurgy and geometry to maximizing power density.
- **More attendees** — buyers and makers from automotive, construction, mining, agriculture — wherever high-performance drives are critical.
- **More solutions** — meet the experts and evaluate your capabilities.

**GEAR EXPO 2015 is the place to be.**

- Make powerful connections.
- See the latest technology in action.
- Get the inspiration you need to take your products to the next level.

Improved drive technology is critical to achieving higher efficiencies and longer service life. All the information and answers you need will be at **GEAR EXPO 2015.**

## VISIT

[www.gearexpo.com/GETECH](http://www.gearexpo.com/GETECH)

Use code **GETECH** when registering.

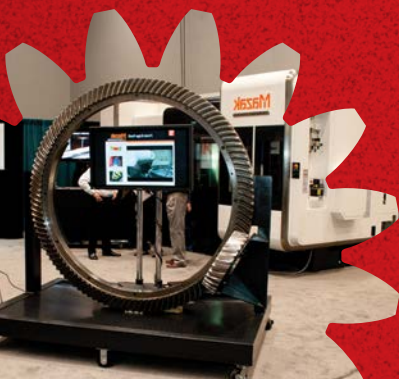

# Precision Gearing Lightens the Load for Off-Highway Equipment

**Smoother surface finishes, tighter tolerances provide better tooth-to-tooth contact**

Jack McGuinn, Senior Editor

**Faith – paraphrasing the gospels of Matthew and Mark – can move mountains.**

But it helps if you have precision-gear equipment.

Now, using precision gearing and off-highway earth-moving vehicles and machinery in the same breath may at first blush seem antithetical, but not so much when you think about it. Ryan Parke, marketing manager for HMC Inc., explains why.

“Other than sub-par manufactured gears that do not mesh well, and eventually break down, I would say the cause (of gear failure) we see most often is either of the following two reasons. The first being improperly installed and aligned gear sets. The first run-off is very crucial, and if everything is not aligned and adjusted properly, the gearing can fail very quickly. The second reason is proper monitoring and maintenance. We have seen customers that have been running without lubrication because there was a problem with the lubrication system and no one noticed for a while. It does not take long for a gear to fail without lubrication.”

Indeed, if you happen to manufacture and sell gears into this highly competitive hornets’ nest of a market, which,



aside from the usual sectors (earth-moving, stone, paper) also includes Navy nuclear propulsion; commercial marine propulsion; hydro power; power generation (coal fired); gas/oil; and on — you appreciate that precision and the maintenance that high-precision gearing requires are givens.

Let’s face it. These days, everyone is fighting over a smaller pie; let’s say — a cherry pie. And in this market no buyer of cherry pies has to settle for one that contains unwanted cherry pits. And besides, many of these applications (see above) already come ready-made with unforgiving tolerances — and standards — to meet. So just to be considered a player requires significant capital (equipment) and human (experience and expertise) investment.

But how does one actually define “precision gearing?” It’s not like it’s a published standard.

“You can always buy “cheaper gearing,” says Parke. “That is to say, gears that are produced on old equipment, or gears that are not held to the kind of tolerances and quality we strive to produce. We generally consider anything above an AGMA quality of 10 to be ‘precision gearing.’”

And the “precision” is found where?

“Smoother surface finishes and tighter tolerances provide better tooth-to-tooth contact,” says Parke. “You want the load spread evenly across the entire tooth. This results in longer gear life, smoother operation, and easier initial installation and alignment.”

Along with the required precision, other challenges remain in manufacturing transmissions for industrial vehicles/equipment. They are not unfamiliar to any manufacturer of complex, high-quality gears for demanding applications.

At HMC, precision’s path typically employs a different process and entails a story, in part, of a lost art.

“The majority of the ‘large gearing’ we manufacture is forged-fabricated,” says Parke. “Meaning, a forged outer



ring and/or hub center section, welded together with structural or forged plate center sections. The lack of quality casting vendors has sent us down this path.

“All of the equipment we use is very specialized. The machines used to produce these parts are more precise, more flexible as far as the shapes and sizes of parts they can accept. They are much more robustly built considering the weights involved, and have enormous technological capabilities as far as on-board inspection.”

### Off-Highway Business Still a Bit Off

By most accounts the collective U.S. heavy equipment industry picture continues on its bumpy path.

According to Brian Langenberg, our dismal science tea reader whose column — Global Industrial Outlook — appears regularly in our sister publication *Power Transmission Engineering*, “The stronger U.S. dollar is enabling Japanese machinery competitors to gain share in the Middle East and Latin America, and lower soft commodity prices translate into a continuing North American decline in demand for farm equipment. Increased Japanese construction equipment competition remains a negative for U.S. manufacturers. And in the long-suffering, crucial mining sector, things only get worse. “Mining,” according to Langenberg, is “not only awful, (but) may be worsening in the U.S. — given continued deterioration in coal fundamentals.”

And in other heavy machinery, he reports “modest incremental demand from non-residential and residential construction markets, but more than offset by soft crane and agricultural markets.”

And last, John Deere, U.S. agriculture’s bell weather (65% market share), finds that its “sales trends are in the tank across every product area, and in particular with larger, high-margin tractors and highly seasonal combines.

Meanwhile, for the industry as a whole the wait continues for Congress to pass some semblance of a long-overdue national infrastructure bill,

As the equipment is specialized, it surely follows that most of the gears it makes are “specialized” — or made-to-order — as well. Which in itself must also present its own set of hurdles, as Parke in fact confirms. As it happens, size not only matters — it complicates things.

“Finding qualified raw material vendors, logistics, specialized and expensive machine tools, and general handling throughout the shop” is a challenge. The fact that very few manufacturers exist in the world today capable

of producing gears of significant size and quality makes everything more difficult. Everything from finding qualified machinists to simply buying a new forklift becomes more and more difficult as size and quality increase.” 

#### For more information:

HMC Gears  
3010 S. Old U.S. Hwy. 41  
Princeton, IN 47670  
(866) 990-9462  
[www.hmcgears.com](http://www.hmcgears.com)

# LUREN

PRECISION CO., LTD.



---

## LWT-3080 WORM & THREAD GRINDING MACHINE





- Combination Direct Drive Motor and Linear Motor
- Smart Grinding- Automatic Stock Dividing
- Automatic Loading and Unloading
- Advanced Grinding for Multiple Worm Types : ZI, ZK, ZA, ZN, ZC
- AGMA Q14 in General Cases

### Our Gear Cutting Tools



Hobs • Shaper Cutters • Master Gears

For over 20 years of manufacturing, Luren offers a wide variety of custom and standard gear cutting tools using the highest quality materials and accuracy to ensure your longest possible tool life.

**Corporate Headquarters**  
Luren Precision Co., Ltd.  
No.1-1, Li-Hsin 1st Road,  
Hsinchu City, Taiwan, 30078  
Phone : +886-3-578-6767  
Email : sales@luren.com.tw  
Website : www.luren.com.tw

**North American Headquarters**  
Luren Precision Chicago Co., Ltd.  
707 Remington Road, Suite 1,  
Schaumburg, IL 60173, U.S.A.  
Phone : 1-847-882-1388  
Email : sales@lurenusa.com  
Website : lurenusa.com



## The Perfect Geared-Assembly

For your Medical, Laboratory, Instrument, Robotics, Semi-Conductor, Automation or other Precision application

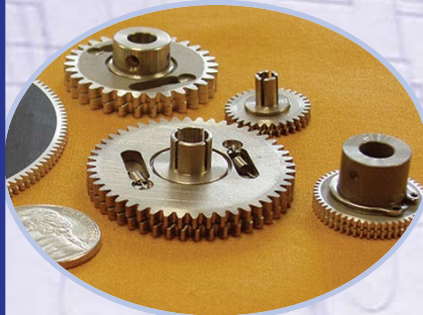

## Custom Solutions

Fully integrated, turnkey solutions including manufacturing, engineering, assembly, testing and custom machining



## Stock Solutions

Choose from over 31,000 standard components, including bearings, belts, couplings, fasteners, gears, gearboxes, linear motion, racks, sprockets, worms and more

  
**Nordex**<sup>®</sup>

INCORPORATED  
Turnkey solutions with a  
higher level of intelligence

**WWW.NORDEX.COM**

**sales@nordex.com**

Phone: (800) 243-0986

or (203) 775-4877

Fax: (203) 775-6552

426 Federal Road Brookfield, CT 06804

**Quality Solutions Since 1960**

which would of course provide a much-needed boost to the heavy machinery sector.

Not going to happen. Not during this Administration, at any rate.

With the 2016 presidential race already underway (in case you didn't notice), much needed action on things like infrastructure repair will take a back seat to debate on red state-blue state issues like gay marriage, gun control, estate taxes and so on.

Following are additional facts and figures, as reported by *Reportlinker*, *Freedonia*, *Hoovers* and *Global Industry Analysts*:

**Market outlook.** The US domestic construction equipment market has seen sales jump almost 60% over the past year. The rebuilding of rental fleets and increased exports in the utility, farming, manufacturing and mining sectors are driving sales higher. Equipment prices have risen just over 1% as production has not yet climbed back up to capacity levels. Prices for equipment and rentals continue to rise due to job site demand as the construction sector rebounds following a slow period caused by the economic downturn.

**Construction equipment and machinery industry market.** Global construction machinery demand is expected to grow at a yearly rate of 6.5% through 2015 to reach a value in excess of \$170 billion, according to *Freedonia*. EU and North America equipment sales

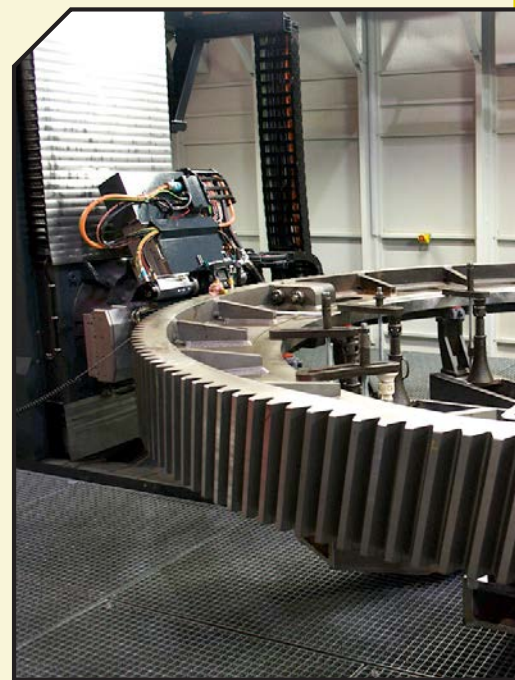

are forecast to rise after an unprofitable period between 2008 and 2010. Growth in other regions such as Asia-Pacific and Africa-Mideast is expected to slow through 2015 in tandem with construction and mining activity.

The construction equipment and machinery industry has been hit by slow economic growth, following the global financial crisis, which took a particular toll on global construction activity. Worldwide demand for construction equipment and machinery suffered a huge falling off after the 2008 economic downturn. Demand fell for three years





All photos courtesy of HMC.

running as investment in construction slowed. In particular, a fall in U.S. domestic housing construction slowed heavy equipment sales.

**Key Market Segments:**

Market growth in terms of sales of excavators, loaders and cranes is forecast to accelerate through 2015. As economic growth picks up again after the slow 2008 to 2010 period, demand for heavy equipment will rebound. Greater investment in urban development - including construction across industrial, commercial and residential sectors - will buoy demand for draglines and cranes. Demand for loaders will also grow as mining output rises. Growing profits in non-building construction

and mining will boost demand for excavators.

**Regional Markets**

- Developed nations are expected to lead demand for equipment, with North America expected to show close to 7% yearly growth in the five-year period ending 2015, according to *Freedonia*. The U.S. market will be driven by residential construction spending gains, as the construction sector rebounds following the 2007 to 2010 downturn. Demand in Mexico is also forecast to grow in the same period.
- There are around 700 companies operating on the U.S. construction machinery manufacturing market, representing combined yearly profit of around \$25 billion, according to *Hoovers*. It is a very concentrated industry, with 85% of overall profit generated by the top 50 companies. U.S. industry leaders include Terex, Hitachi, Caterpillar and Komatsu. Third-quarter construction activity in the U.S. in 2011 pointed to a rebound in the construction industry, boding well for construction equipment demand.
- The largest share of new demand for construction equipment in the five-year period ending 2015 is expected to come from Asia-Pacific, according to *Freedonia*. Construction machinery sales are expected to increase almost 7% a year through 2015, fuelled by a higher degree of mining output and construction spending gains. China will represent almost 40% of new construction machinery demand until 2015, and growth will also accelerate in Indonesia and Malaysia.

For Related Articles Search

off-highway

at [www.geartechnology.com](http://www.geartechnology.com)

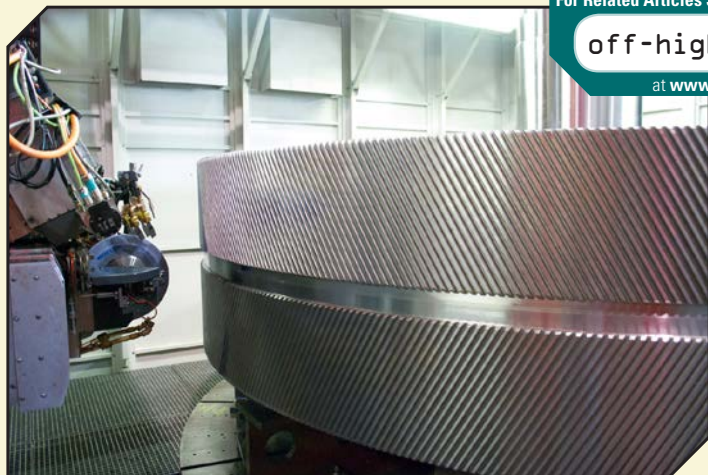

**OPEN DIE FORGINGS & SEAMLESS ROLLED RINGS**



**ALL PARTS ROUGH MACHINED 100% UT TESTED**

**108" Max O.D. 6" Min O.D.**

**Up to 55,000 lbs**

**FAST QUOTES**

**48 HOURS OR LESS**

**ISO9001:2008 AS9100/2009C**

**All Metals & Forge Group**

**STEELFORGE.COM**

**800.600.9290**

**973.276.5000**

As a value added service to its customers, AM&FG sponsors **Manufacturing Talk Radio**, The Voice of Manufacturing Globally



**MFGTALKRADIO.COM**

**Live Broadcast On the Web Every Tues. at 1PM EST**

# Off-Highway or Off-Press, Andantex Focuses on Precision

Jack Mc Guinn, Senior Editor

**Andantex USA is a part of the worldwide Redex group, a long-time provider of high-precision motion control components and systems** (hi-tech planetary reducers, dedicated rack-and-pinion drives; servo reducers; modular rack-and-pin-

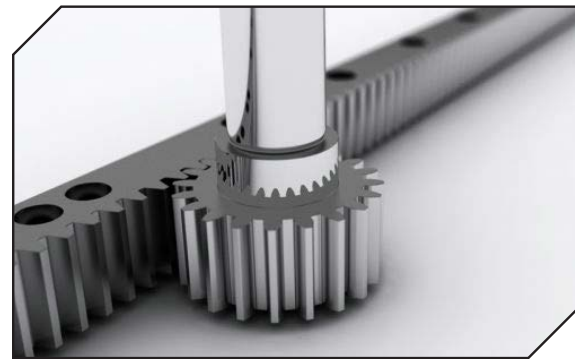

Andantex precision rack-and-pinion system

ions; spindle drive gearboxes; right-angle gearboxes; industrial differentials; multisppeed transmissions; Merobel magnetic particle brakes and clutches; torque limiters; and web tension control systems. The company's long history—both here and in Europe—and reputation for quality precision has made Andantex a choice provider of the machine tool, aerospace; automation/material handling, converting, printing and packaging industries. The company site makes it clear that “all sales, engineering, manufacturing and after-market support” are located at their U.S. headquarters in Wanamassa, New Jersey.

But because much of its business is done in Europe, the gears and gearboxes Andantex manufactures for various applications there must also meet strict CO<sub>2</sub> mandates. And that mandate applies—whether the application is heavy-equipment vehicles, automobiles or commercial vehicles. Here, too, precision is critical, as Regiec confirms regarding gearbox efficiency.

“We (also) supply spiral bevel gearboxes that are used on vehicles to drive pumps for the oil industry,” says Dave Regiec, Andantex USA vice president of engineering. “The primary way that we decrease the CO<sub>2</sub> emissions of those vehicles is by improving the efficiency of the gearboxes to decrease the power losses and use less energy.”

## Gear Workholding.

If it's hard to hold...  
the answer's  
not hard  
to find.

www.forkardt.us

When it comes to workholding solutions for gear machining, ITW Workholding provides a wealth of technical knowledge, expertise and engineering assistance that sets us apart. Our various designs include our N.A. Woodworth Universal Gear (UG) and our newly developed Pitch Line (PLD) diaphragm chucks. We have the product to fit your process. All built with exacting standards to provide the best workholding solutions for gear machining. Give us a call.



**FORKARDT**

2155 Traversefield Drive • Traverse City, MI 49686  
800-544-3823 • sales@forkardt.us

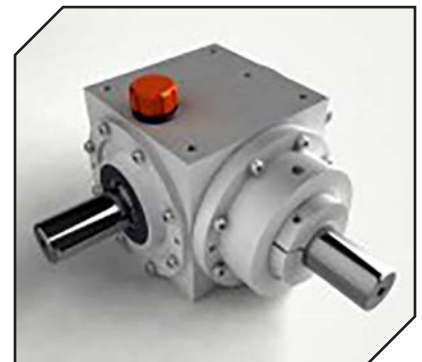

Andantex spiral bevel gearbox

Regiec is a firm believer in that regardless of how well the gears are made, when it comes to maintenance in the field, attention must be paid. Indeed, maintenance requires a precision of its own.

“Maintenance—including oil level checks on a weekly or monthly basis, as well as oil changes every 10,000 hours—are critical to ensure long life.”

## For more information

Andantex USA  
1705 Valley Road  
Wanamassa, New Jersey 07712  
Phone: (800) 713-6170; (732) 493-2812  
Fax: (732) 493-2949  
info@andantex.com

## Redex-Andantex Drives Go Green

*KRP6: the largest low-backlash reducer in the world—with HQ-GF technology.*

High-quality planetary gearboxes are energy-efficient solutions for linear and rotary backlash-free axis drives with efficiencies above 95%.

Redex-Andantex engineers are going one step further, introducing to the machine tool industry a new gear finishing HQ-GF (high-quality gear finishing) technology that insures less noise, higher efficiency, and above all a decrease of more than 15% of power losses. Thousands of kWh saved over a machine lifetime.

This technology was co-developed with the Swiss company Fässler S.A., well known for its honing machines that have revolutionized automotive gearbox production and increased car performance.

Gearboxes supplied by Redex-Andantex to DMG use this high-quality gear finishing technology, giving DMG-DMU600 machine tool, one of the best energy performance ratings in its class.

KRP planetary reducers with HQ-GF are among the many innovations brought to the machine tool industry by Redex-Andantex engineers.

Redex is part of the European Commission Eco-Design of Machine Tool Directive group (based on ErP 2009/125/EC) and is involved in the new ISO 14955 Environmental Evaluation of Machine Tools standard.

Redex-Andantex gearboxes are supplied with recycling guidelines to help OEMs manage the complete gearbox life cycle.



**teco**  
Werkzeugmaschinen  
GmbH & Co. KG

# WELL MAINTAINED Machine Tools from Germany

Our machines run through tests, are supplied with certificates and to be seen under power

## BORERS, HBM

- CNC SKODA, 1990/2007, spindle 250 mm, X/Y/Z/W=7000/6100/2000/1600 mm, Z+W=3600 mm, latest CNC
- CNC TITAN, 1984/2010, spindle 200 mm, X/Y/Z/W=9000/4000/1200/800 mm, Z+W=2000 mm, latest CNC
- UNION, 1984/2011, spindle 110 mm, table type, table 1600 x 1400 mm, latest DRO

## VTLS, DOUBLE COLUMN

- TITAN, 1983/2013, faceplate 2000 mm Ø, swing 2200 mm,
- CNC TITAN, 1983/2011, faceplate 2500 mm Ø, swing 2700 mm,
- TITAN 1987/2012, faceplate 4000 mm Ø, swing 5000 mm,

## GEAR GRINDING

- CNC REISHAUER RZ 400, 2002, in state-of-the art, gear-Ø/module 400/8 mm
- CNC REISHAUER RZ 150, 2004, in state-of-the art, gear-Ø/module 150/3 mm
- CNC REISHAUER RZ 362, 2000, tested + certified, gear-Ø/module 360/7 mm
- CNC HÖFLER H 1250+1253, 1996+1991, tested and certified, gear-Ø/module 1250/25 mm
- CNC HÖFLER H 2500/3100, 1994 retrofitted and upgraded with 10 axes CNC, tested and certified. gear-Ø/module 3100/32 mm

## Think SMART and ECONOMICAL

see details + pictures under

[www.teco-germany.com](http://www.teco-germany.com)

**TECO Werkzeugmaschinen GmbH & Co. KG**

Westring 1, 40721 Hilden, Germany

Tel.: +49 2103/3682-0 / Fax: +49 2103/3682-20

E-mail: [info@teco-germany.com](mailto:info@teco-germany.com)

And also gear hobbers, shapers + other machine tools

## GENIS CF

Vitrified bond CBN grinding tools with composite cores for external cylindrical grinding

GENIS CF was designed with an innovative carbon fiber-reinforced composite core for external cylindrical grinding applications. In addition to a weight reduction of up to 80%, this tool concept is characterized by special damping abilities, which lead to improved grinding quality and increased tool life.



### Benefits of GENIS CF

- + Low weight
- + Best damping
- + Lowest cost per unit
- + Resegmenting available

To learn more about our grinding products please visit [radiac.com](http://radiac.com) or contact our **GEAR TEAM** at 630.566.9785 | [gear@radiac.com](mailto:gear@radiac.com).

A TYROLIT Company  
[www.radiac.com](http://www.radiac.com)

**Radiac**  
Abrasives

# Gleason



**WORKPIECE  
CHANGEOVER –  
IN THE TIME IT  
TAKES TO READ  
THIS AD**

**SOLUTIONS FOR CYLINDRICAL AND BEVEL GEARS OF ALL TYPES AND**

✓ Bevel Gear Solutions,  
Up to 2,500 mm

✓ Cylindrical Gear Solutions,  
Up to 10,000 mm

✓ Metrology Solutions,  
All Types of Gears,  
Gear Tools

✓ Cutting Tools and  
Workholding Solutions,  
All Processes

**For worldwide sales locations and additional information, visit:**



THE  
**TOTAL GEAR**  
**SOLUTIONS™**  
PROVIDER

Changeover slowing you down?  
Gleason's new Quik-Flex®Plus  
workholding system can:

- ✓ Cut cylindrical gear changeover time to just 30 seconds or less.
- ✓ Eliminate all the usual tools and hardware.
- ✓ Help ensure exceptional accuracy and repeatability.



It's just one of a new generation of quick-change workholding solutions for many gear, and non-gear, applications.

Make the change today.  
Visit: [www.gleason.com/QF](http://www.gleason.com/QF)



*Install a new Quik-Flex®Plus module onto the common workholding interface...*



*With just the twist of the activation handle installation is now complete.*

**Put Quik-Flex®Plus to the test:  
September 23-24, 2015**

Take the Quik-Flex®Plus challenge at the 4th Gear Solutions Forum, in Rochester, NY. It's just one of dozens of demos, lectures and networking opportunities at the gear technology educational event of the year.

Get a head start on the future.  
Get the details at:  
[www.etches.com/gleasonsfs2015](http://www.etches.com/gleasonsfs2015)

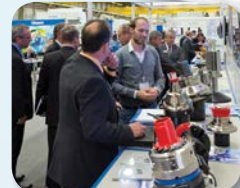

**SIZES, EVERY PROCESS**

- ✓ Global Services, 250 Factory-Trained Personnel in 30 Countries Worldwide

**Gleason**

# Gear Mesh

## QUESTION #1

When assembling a pair of gears, what is a good method for setting and checking their mesh?

**Expert response provided by: Dr. Robert Winfough and N.K. (Chinn) Chinnusamy** (A previous answer to this question, written by Robert Wasilewski of Arrow Gear, appeared in the May 2015 issue).

The question is quite broad, as there are different methods for setting various types of gears and complexity of gear assemblies, but all gears have a few things in common.

When assembling spur or helical gears, backlash and contact pattern are important. Depending on the precision of the gear boxes, inspecting other items prior to assembly may also be wise. Before assembling high-speed gearboxes, all gears should be visually inspected to make sure there are no burrs or damage

which will contribute to noise and premature wear. The gear housing should be CMM-inspected for center distance and alignment of bores to make sure they are within the tolerance specified. When multiple gear centers are involved, it is often difficult to check backlash; hopefully the gearbox design allows for inspection access. The backlash within each mesh should be checked along with contact pattern before assembling other gear centerlines. Bearing preload or controlled looseness are also important, depending on the speed. Of course, proper lubrication of gears and bearings should be considered for long gear and bearing life.

Bevel gears are generally manufactured as matched sets; individual members are not interchangeable between

sets unless ground to a master. The quality of performance that is designed and manufactured into a set of bevel gears can only be achieved by correct mounting of gears at assembly. Gears assembled with improper mounting will wear excessively, operate noisily and possibly fail. Here again, checking the backlash and contact pattern should be done.

In assembling bevel gear (straight, spiral, and hypoid) the following must be observed.

Understanding of the need for correct positioning of bevel gears

Inspection data necessary for correct assembly and positioning of bevel gears in the housing

Instruction to assembly personnel for obtaining tooth contact patterns, for interpreting tooth contact patterns, and

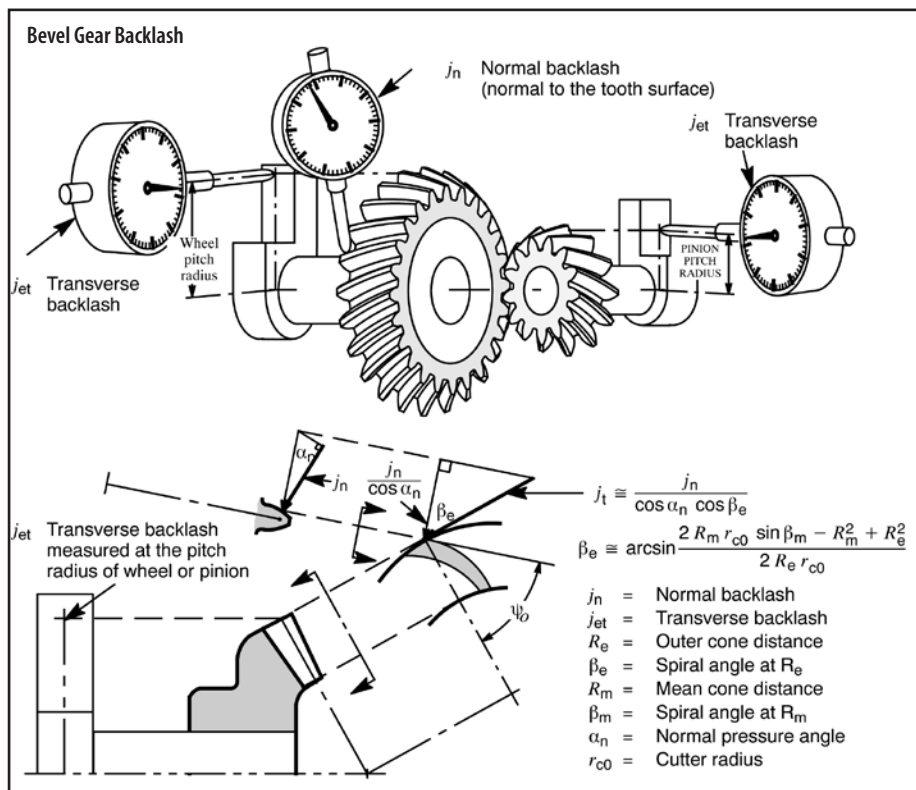

Extracted from ANSI/AGMA 2008 - D11, Assembling Bevel Gears, with the permission of the publisher, the American Gear Manufacturers Association, 1001 North Fairfax Street, Suite 500, Alexandria, Virginia 22314.





# NVH Evaluation

## QUESTION #2

We are designing a DCT gearbox for 249Nm engine torque. To evaluate for NVH we have initially calculated the gear mesh frequency for 1, 2, 3 order. We have observed there is only a 5% difference between gear mesh frequency of 1st order and 3rd order when 6th gear engaged. Could you please suggest what should be minimum acceptable difference between 1st-, 2nd- and 3rd-order gear mesh frequency to avoid resonance, and why?

adjusting the position of members to change tooth contact patterns and backlash

For more detailed assembly instruction, please refer to ANSI /AGMA 2008 D11 standard.

Answer provided by N.K. Chinnusamy at Excel Gear in Roscoe, IL ([NChinnusamy@excelgear.com](mailto:NChinnusamy@excelgear.com)); and Dr. Bob Winfough of Hypergears LLC ([info@hypergears.com](mailto:info@hypergears.com)).

For Related Articles Search

assembly

at [www.geartechnology.com](http://www.geartechnology.com)

Proper bevel gear assembly can be confirmed by checking the contact pattern via marking compound.



### Expert response provided by Robert Winfough:

When evaluating a gear system for noise, vibration and harshness (NVH) regardless of the type of gear box, one will have design requirements of interest. Noise and vibration are often set by subjective feel and then converted to an engineering unit. In the question it is stated that there exists a 1<sup>st</sup> order and 3<sup>rd</sup> order that are only 5% different when engaging 6th gear. The question is— can one suggest a minimal acceptable difference between first-, second-, and third-order gear mesh frequency to avoid, and why?

Breaking the question into several parts might be best.

First and foremost, the lower orders of a gear box are often NOT the most significant in terms of creating issues. The order that is most important is the order that aligns with the most flexible natural mode of vibration. Aligning more than one shaft or mesh on top of these flexible natural modes is the biggest issue. These issues are the ones in which issues can be catastrophic and are often missed in design as typical modal analysis does not effectively shows the relative stiffness of the assembly.

It is most common in gear boxes to pay close attention to intentionally mismatching orders as is suggested and referenced by the comment of delta between two meshes of 5%. What is the acceptable difference? This is a difficult question as the design requirements for the gear box really control the amount of acceptance. For example the noise

from a farm implement gear box and that of a luxury automobile will be different. However some physics regardless of the type of gear box is the separation of the orders should be maximized to prevent the real parts of the frequency response functions from summing together. By reviewing orders, one is looking more closely to the peak of the forcing function. Shifting the orders by several times the modal damping ratio is best. A typical damping ratio is heavily dependent on the bearing structure, assuming the assembly is constructed of a rolling element, such as ball, roller, tapered bearing of some sort, the shafts of interest is likely to have 2 to 3% damping. So shifting the orders from 8-12% is probably good enough in nearly all cases, but further is best. Many shafts will only have 1% damping or less, so in those cases proportionally lower limit may work well. If a prototype exists, understanding the measured gear box frequency response function may help substantially.

Now to the second part, why is it set so far away? Aligning multiple shaft forcing functions can cause premature wear as a result of the resonance that is being driven. It can also create extra noise in a cabin of automobile. Noise a large contributor to warranty returns, to the tune of millions of dollars in warranty annual for automakers.

For Related Articles Search

noise

at [www.geartechnology.com](http://www.geartechnology.com)

# The Basics of Gear Theory

Hermann J. Stadtfeld

## Bevel Gears: By the Book

Beginning with our June Issue, *Gear Technology* is pleased to present a series of full-length chapters excerpted from Dr. Hermann J. Stadtfeld's latest scholarly — yet practical — contribution to the gear industry — *Gleason Bevel Gear Technology*. Released in March, 2014 the book boasts 365 figures intended to add graphic support of a better understanding and easier recollection of the covered material.

Who should read this book?

*Gleason Bevel Gear Technology* is written for specialists in planning, engineering, gear design and manufacturing; in short — *you*. This work also addresses the technical information needs of researchers, scientists and students who deal with the theory and practice of bevel gears and other angular gear systems. Indeed — it is the first textbook available worldwide that not only addresses all the above — it also provides methods and practical hints for their application.

The introductory chapters lead engineers — and students without gear experience — in easy-to-understand language (and nomenclature) through the basics of modern cylindrical and bevel gear technology. Next, the fields of industrial application of bevel gears are illustrated via vivid photographs of examples with supplemental explanation of why such products require bevel or hypoid gears. The third part of the book is dedicated to roll testing, coordinate measurement and corrections of bevel gears. The heat treatment of bevel gears appears after the chapters on manufacturing methods. Because heat treatment is not a bevel gear-specific technology, this progression of chapters makes sense in terms of enhancing continuity and flow in reading.

Following is the first half of Chapter 1: "The Basics of Gear Theory."

### Introduction

The most basic case of a gear train is the transmission of rotation and power between two parallel shafts. This is a two-dimensional case which allows for observation in a plane. If the transmission of rotation should occur with a constant ratio, which means that in case of a constant input RPM the same or different, constant output RPM is required, then it is necessary to satisfy the following form of the gearing law:

$$IN_1 \times R_1 \cdot i = IN_2 \times R_2 \cdot i = \text{const} \quad (1)$$

where:

- $N_1$ ... normal vector tooth flank point 1
- $R_1$ ... radius vector tooth flank point 1
- $N_2$ ... normal vector tooth flank point 2
- $R_2$ ... radius vector tooth flank point 2
- $i$ ... transmission ratio

The requirement of Equation 1 has to be fulfilled for an infinite number of points which are involved in the rolling process of a tooth pair. In other words, a continuum of point pairs that fulfill Equation 1 is required, which will form two lines, each of which is connected to an axis of rotation (this line is the two-dimensional form of the tooth flank). For gear drives, in contrast to traction drives or belt drives, it was found acceptable that the constant rotational transmission

is limited to a discrete angular increment (employing the described pair of lines), if a smooth transition to a following pair of lines is possible. The pairs of lines are tooth profiles in a plane, perpendicular to the axes of rotation. The idea to employ discrete elements on the circumference of two disks in order to transmit rotation that is constant and smooth was the invention of gears. This principle, which was revealed in Antiquity, poses many questions:

Are there flank forms which can satisfy the mentioned requirements? Is it possible to manufacture those flank forms efficiently? Will there be sufficient overlap during the change from one pair of teeth to the next? And, even then, will the engagement of the consecutive tooth pairs be smooth or will there generally be a load dependent impact?

The search for a suitable flank form is the subject of this paper. Therefore, a

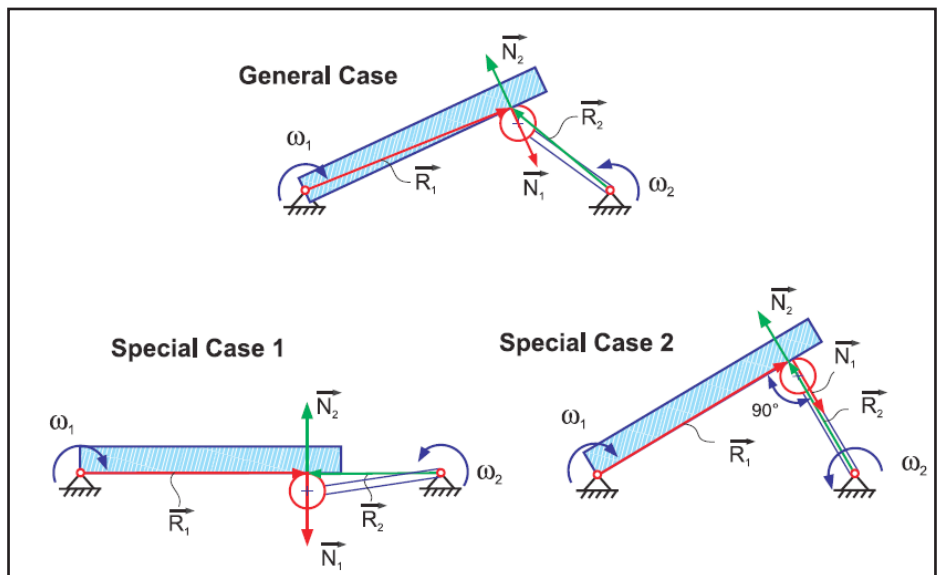

Figure 1 General transmission case and its two special cases.

general case and its two special cases will be observed.

The top graphic in Figure 1 shows the general case of contact between a circle and a straight line. The configuration between the contacting elements and the two axes of rotation establishes a certain transmission ratio between the axes where the question is: Does this ratio remain constant if the transmission elements are rotated incrementally; i.e. — which requirement to the flank form has to be fulfilled in order to achieve a constant ratio? The two special cases (lower section, Fig. 1) have been constructed to elaborate on those questions. The left, lower graphic in Figure 1 shows the case of parallel radius vectors. The normal vectors are oriented perpendicular to the radius vectors, which is why the vector products of Equation 1 equal the magnitudes of the radius vectors within the absolute symbols. The result is an instant ratio of:

$$i = R_2/R_1 \quad (2)$$

The right lower graphic in Figure 1 shows the second extreme. The two radius vectors are perpendicular to each other, which causes the pair of normal vectors to be perpendicular to  $R_1$ —but parallel to  $R_2$ . The left vector product in Equation 3 delivers therefore the absolute amount of  $R_1$ , where the right vector product delivers the “zero” as a result.

$$i = 0/R_1 = \omega_1/\omega_2 = 0 \quad (3)$$

where:

- $\omega_1$  angular velocity member 1
- $\omega_2$  angular velocity member 2

This means that an instant rotation of element 2 has no influence on the position of element 1. The three discussed cases show an extreme change of the transmission ratio dependent on the rotational position of the contacting elements (Ref. 1).

### The suitable flank form

Based on the teachings of Figure 1, a flank form is wanted, whose vector product from radius and normal direction in any instant transmitting point remains constant during rotation (i.e., in any angular position). This flank form should favorably be developed without knowledge of the mating flank. The last claim becomes important in connection with

profile shift and center distance change, which is the subject of a later section, “Generating the Involute.”

A crossed belt drive presents similar conditions (Fig. 2) (a straight line connects two circles). The material elements of the belt, when shifted along the connecting straight line, result in a constant transmission ratio between disk 1 and disk 2. If one imagines finite surface elements whose normal direction in any case are consistent with the direction of the connecting line, then the requirements for a constant transmission ratio are fulfilled. The vector product only yields the perpendicular portions of the two multiplied vectors, which is why the solution for Equation 1 is given for any point along the connecting line as:

$$R_{b1} \cdot i = R_{b2} \quad (4)$$

where:

- $R_{b1}$  radius magnitude of base circle 1
- $R_{b2}$  radius magnitude of base circle 2

If the finite surface elements are connected with the respective disk, then based on disk 1 in Figure 3, the rotation of the surface element “a” around Axis 1 about the angular increment between  $R_a$  and  $R_b$  rotates the green element “a” up, in the position at the arrow tip of  $R_b$ . This equals the rotation required in order to move from contacting point “a” to contacting point “b” along the connecting line (Fig. 2). The connecting line (Fig. 1) 2 becomes the line of engagement in Figure 3. If the explained construction is applied to the surface elements “a”

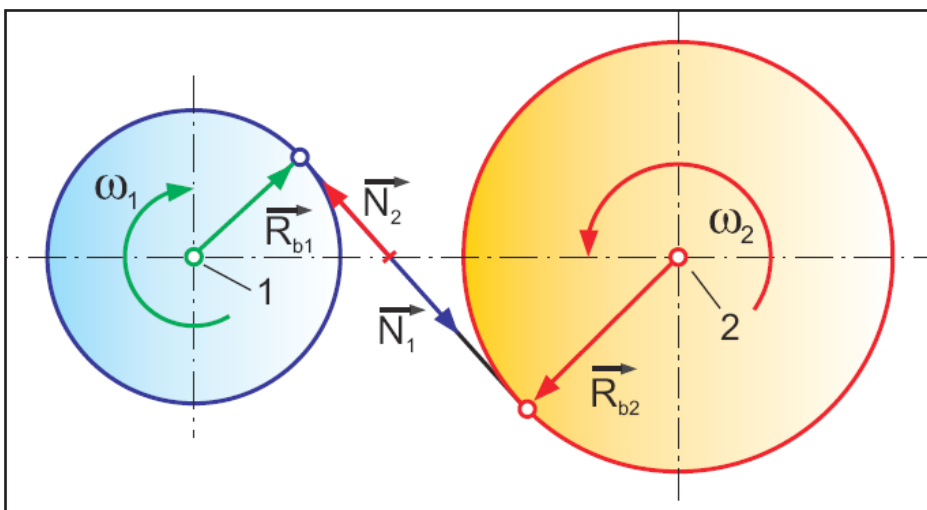

Figure 2 Line of constant vector products.

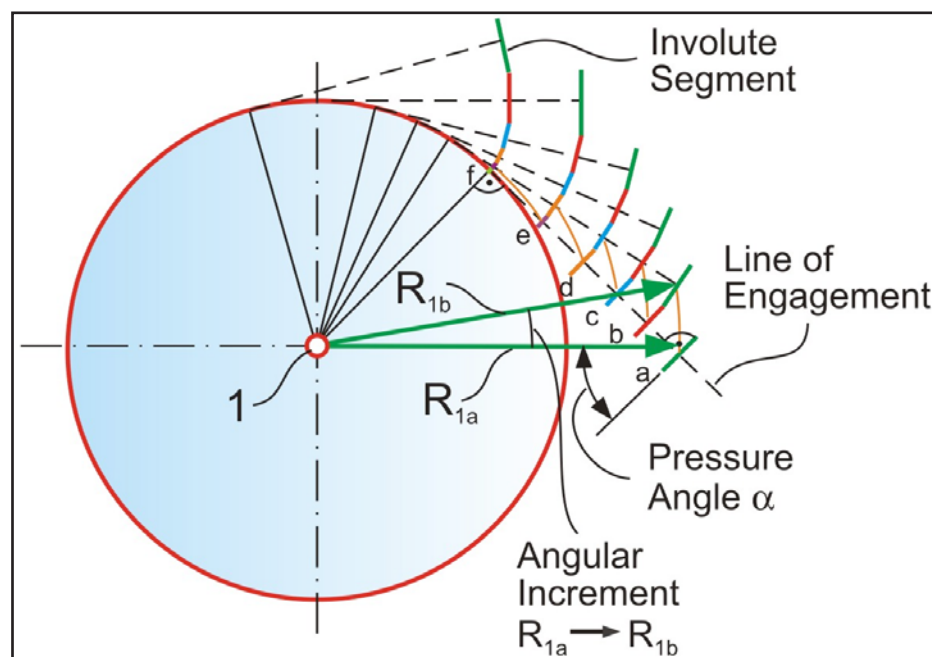

Figure 3 Surface elements that fulfill constant vector products.

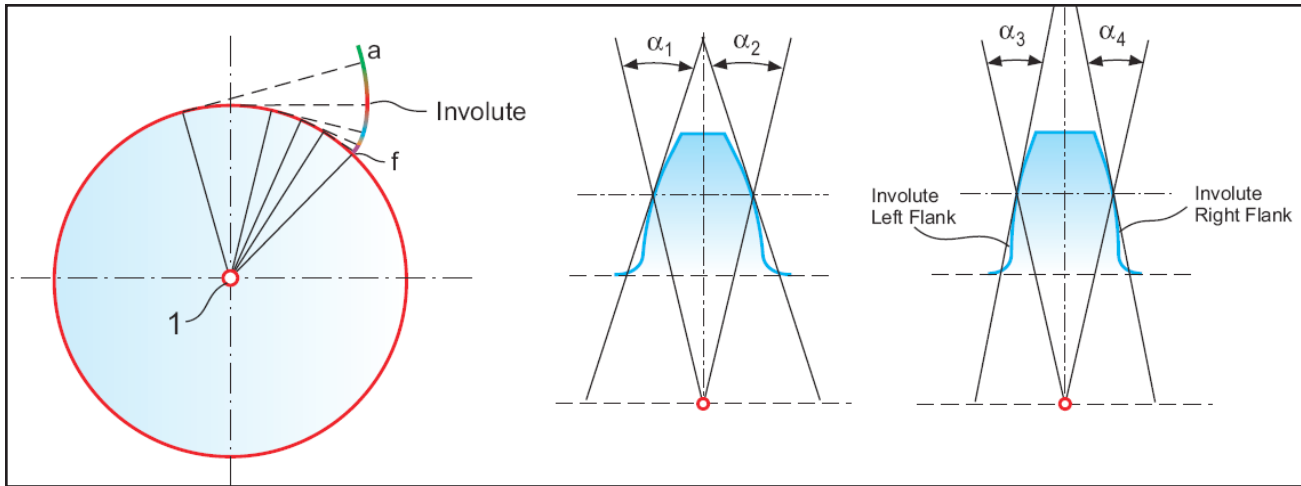

Figure 4 Continuum of connecting points.

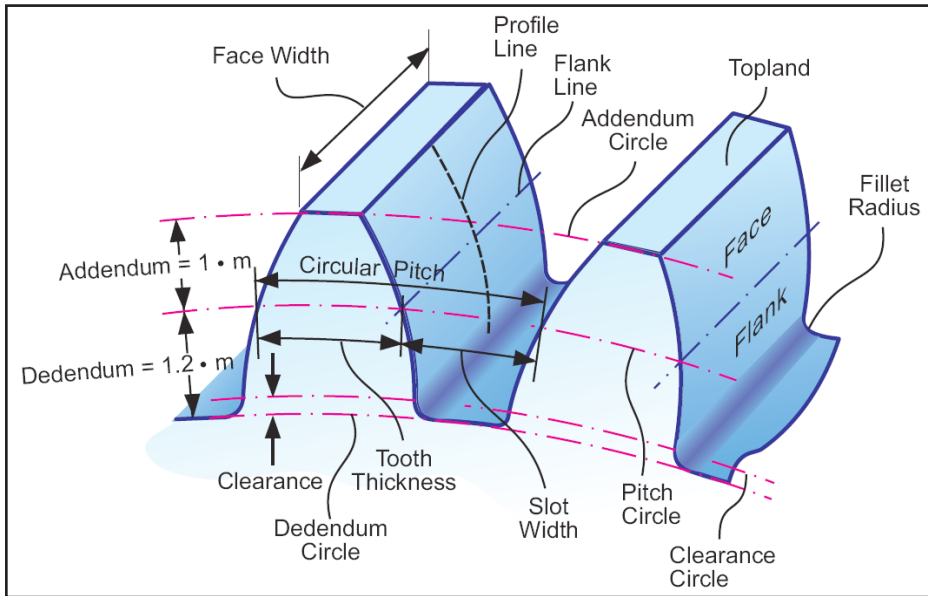

Figure 5 Tooth proportions.

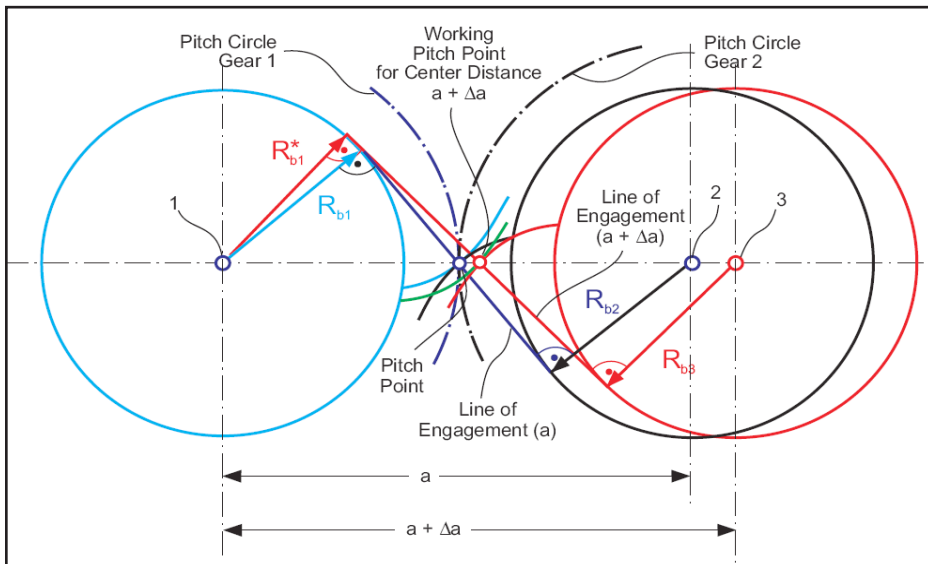

Figure 6 Center distance insensitivity of involute gearing.

through “*f*,” then a flank form with variable curvature — as shown above position “*f*” — is the result. Studying the construction of the resulting flank form in Figure 3 shows the analogy to the involute construction with a cord. The cord in this case is wound around the base circle and then gets unwound, with its end under tension, from position “*f*” to position “*a*.”

The dashed lines in Figure 4 symbolize the cord in discrete, unwound positions. The end of the unwound cord traces a curve — i.e., flank form — which mathematically represents an involute. The right part of Figure 4 demonstrates the tooth form in case of a standard pressure angle ( $\alpha_{1,2}$ ) and in case of a small pressure angle ( $\alpha_{3,4}$ ), assembled from a left and right flank. Both tooth forms (pressure angles) can be generated from the same involute (Fig. 4, left) by choosing the section of the tooth depth (height) closer to the base circle (small pressure angle) or radially farther away from the base circle. If the pitch diameter should remain constant during a pressure angle change, it is, for example, possible to reduce the base circle diameter in order to increase the pressure angle.

The requirement to keep the cross-product for each of the transmission elements independent from one another and constant, as well as the idea of employing the functionality of a crossed belt drive as an example for the movements of finite surface elements, led without any mathematical derivations or analysis to an interesting solution. The involute has a number of remarkable properties (in contrast to other flank forms), like its manufacturability via a simple trap-

ezoidal rack profile and its insensitivity to center distance changes between two engaged gears.

A continuous transmission of rotation between two axes is not possible with only a single involute on the circumference of each of two engaged disks. A continuous transmission requires the continuation of the rotational transmission process by the discrete pair of involutes on several positions along the circumference of each disk. The repetition of the flank structure is illustrated in Figure 5. The angular distance of the teeth along the circumference of a disk is called “pitch” or “circular pitch.” Using the relationship between module and pitch in Equation 6 assures sufficient overlap during the change of transmission contact from one pair of teeth to the next. In order to allow transmission in both rotational directions it is necessary to develop an opposite involute as a mirror image of the first developed involute. The opposite involute can be developed using a line of engagement which corresponds to the second part of the crossed belt. The angular distance between the two involutes of one tooth is normally defined as half-a-pitch reduced by half-the-amount of the desired backlash.

$$p_w = 360^\circ/z ; p_B = (d_0 \cdot \pi)/z \quad (5)$$

where:

- $p_w$  angular pitch
- $p_B$  circular pitch
- $d_0$  pitch diameter
- $z$  number of teeth

The module is introduced in order to standardize the tooth proportions; Figure 5 includes the most important tooth proportions.

Common values for the tooth proportions are:

$$p_B = \pi \cdot m \quad (6)$$

$$h_K = 1.0 \cdot m \quad (7)$$

$$h_F = 1.2 \cdot m \quad (8)$$

$$H = h_K + h_F = 2.2 \cdot m \quad (9)$$

where:

- $m$  module
- $h_K$  addendum
- $h_F$  dedendum
- $H$  whole depth

The addendum is larger than the dedendum to assure that the tops of the mating gear teeth can pass the root area

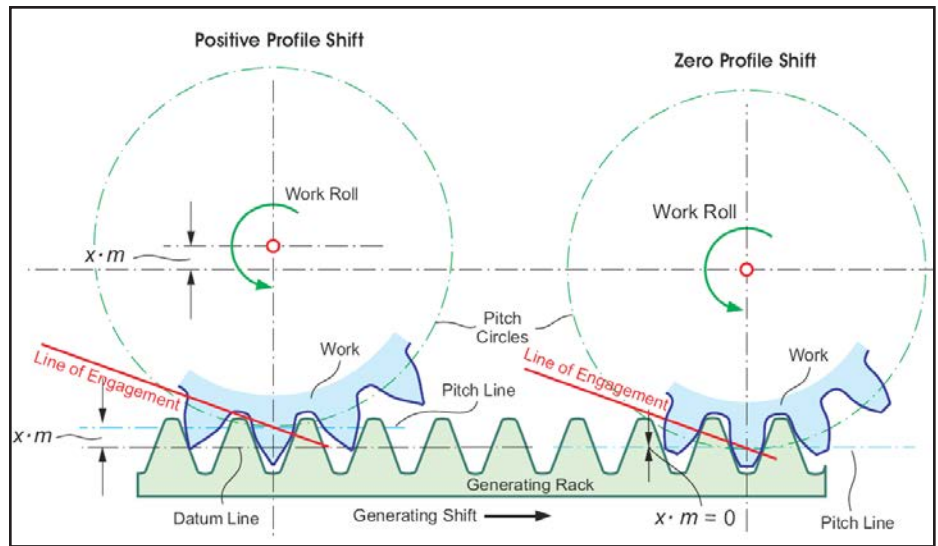

Figure 7 Involute development with straight generating rack.

without interference. In addition, the extra space in the root area is used for a root fillet radius as a transition between the involute flank and root bottom.

### Involutes and Center Distances

The interaction between two involutes is schematically shown (Fig. 6). The pitch circles divide the center distance into the two operating radii for transmission of the rotation. The connecting line between the two axes intersects with the line of engagement at the tangential contacting point of the two pitch circles (pitch point). If the two meshing involutes are rotated until their contacting point matches the pitch point, then a condition of rolling without sliding exists. A further rotation to contacting points — above or below the center distance connection line — changes the pure rolling to a combination of rolling and sliding (general mesh condition). The angle between the center distance connection and a line perpendicular to the line of engagement is called the pressure angle (Fig. 3). A shifting of gear “2” with its center into position “3” ( $a + \Delta a$ ) results in a new line of engagement. With a small rotation of the two gears 1 and 3 the contacting point can be moved to lie again on the center distance connection. This point is called the “working pitch point” because here only rolling without sliding occurs. The working pitch point divides the center distance (just like the pitch point before) according to the transmission ratio. A rotation of gear 1 in clockwise direction shifts the contact

point along the line of engagement (like in case of the original center distance “ $a$ ”) where the surface normals of the flank contacting point will match the direction of the new line of engagement. Therefore, the absolute amount of the vector product between the normal vectors and the radius vectors will also here equal the magnitude of the base circle radii. This in turn causes the ratio between gear 1 and gear 2 to be identical to that between gear 1 and gear 3. This particular effect is called the “center distance insensitivity of involute gearing.”

### Generating the Involute

A generating rack as shown (bottom, Fig. 7) has cutting edges that are oriented perpendicular to the line of engagement. One edge of the trapezoidal profile (Fig. 7) is drawn to match the pitch point. A horizontal shifting of the generating rack to the right creates at the right side of the observed center tooth the addendum profile (or the lower part of the involute in Figure 7); and on the left side of the same tooth the dedendum profile. The gear is rotated counter-clockwise during this generating rack shift as if the pitch circle of the gear would roll on the pitch line of the generating rack without any sliding. The straight cutting edge profile will be perpendicular to the line of engagement in any shift position — which is why this arrangement fulfills the requirements of the involute forming process — as shown with the cord construction.

The right part of Figure 7 explains how a work gear shift away from the rack

with an amount of  $\times .m$  leads to a shorter involute between the pitch line and the root and to an extended involute between the pitch line and the tip of the tooth (a different section of the same involute is used). As result, a stubby tooth with larger tooth root thickness and reduced tip thickness is generated. The tendency of a so-called “undercut” condition (compare Figure 7, left and right) is eliminated due to this work gear shift. The work gear shift is called “profile shift” (or addendum modification).

If the gear with profile shift is mated with a “zero profile shift gear,” then the pair has a center distance, which is enlarged by the amount of the profile shift. In order to re-establish the theoretical center distance, the mating gear can be manufactured with the same amount of profile shift—but with a negative sign. Such a gearset is called a “V0 pair;” it can be exchanged in an existing gearbox with a non-profile shifted set. V0 pairs keep their pitch circles as operating roll circles. In the case of varying profile shifted pairs—in addition to the change in center distance—a change in the operating roll circle and a change in the operating pressure angle is observed. Every combination between varying profile shifted gears is possible and has no influence on the transmission ratio; i.e.—the constant transmission of rotation (Refs. 2–3).

This manufacturing principle via toothed rack exists in practical form as a planing method (Fig. 8, left). A reciprocating planing rack—which performs a combination of cutting and withdrawn reverse stroke—is shifted sideways while the work gear rotates a predetermined amount in order to generate the involute profile.

For soft cutting, “threaded” hobs (Fig. 8, right) are mostly used. The discrete cutting blades are grouped along a helix on the surface of a cylinder. Hobs are swiveled to an angular position in order to compensate for the helix lead angle. During the continuous hob rotation, a feed motion moves the hob along the face width of the work gear (“E” in Fig. 8). In case of a single start hob, the work gear will rotate one tooth (one pitch) during one hob rotation. A number of other methods for the manufacture of involute gears are also derived from the generating principle with a trapezoidal rack.

The so called profile cutting or grinding methods are based on cutting or grinding tools whose tooth forming profile sections represent a negative “involute.” Profile tools are more difficult to manufacture than generating tools, and are more sensitive to positioning errors and process related kinematic, i.e.—dynamic influences.

## The Conclusion from the Cylindrical Gear to the Bevel Gear

It is possible to apply the conclusions of the preceding sections in a similar form also to three-dimensional gearing applications. If motion and force should be transmitted between two non-parallel axes, the solution beyond to worm gear drives and crossed helical gear drives is the most remarkable case in gearing—bevel gears. These are angular transmissions with conical gears that have straight or curved teeth in direction of the face width. Depending on the axes orientation, bevel gears are divided in straight or spiral bevel gears with intersecting axes, and hypoid gears with crossing axes which are separated by an offset. The different bevel gear types are explained in Chapter 3 in detail with their properties and applications.

The conclusion from “N to N+1” from the cylindrical gear to the bevel gear can be created intuitively if the generating rack (Fig. 8) is placed on a flat surface and then bent around a vertical axis (Fig. 9). If the rack is imagined to consist of thin, elastic material, then only the cylindrical section through the middle of the face width of the toothed ring (Fig. 9) shows the original trapezoidal rack profile (Fig. 8), i.e.—rolled on the surface of said cylinder.

The trapezoidal profile reduces in size proportionally towards the center and enlarges proportionally towards the outside. If this proportional profile distortion does not only apply in circumferential direction but also in vertical direction, then the optimal generating gear for straight bevel gears has been created. This leads to a simple explanation of the generating principle in Figure 9. If a disk from modeling clay is pressed from the top into the profile of the generating gear and a slip free rotation between disk and generating gear occurs, then teeth with nearly involute profiles are formed. The profiles formed in this experiment are spherical involutes, or octoids of the first kind. If the same experiment is repeated with a disk from modeling clay from the lower side of the generating gear, then a second bevel gear with an octoid profile is created. Remarkably enough, in the conducted brain experiment the most elementary case of the kinematic coupling requirements between two gears has been realized. If it is possible for the

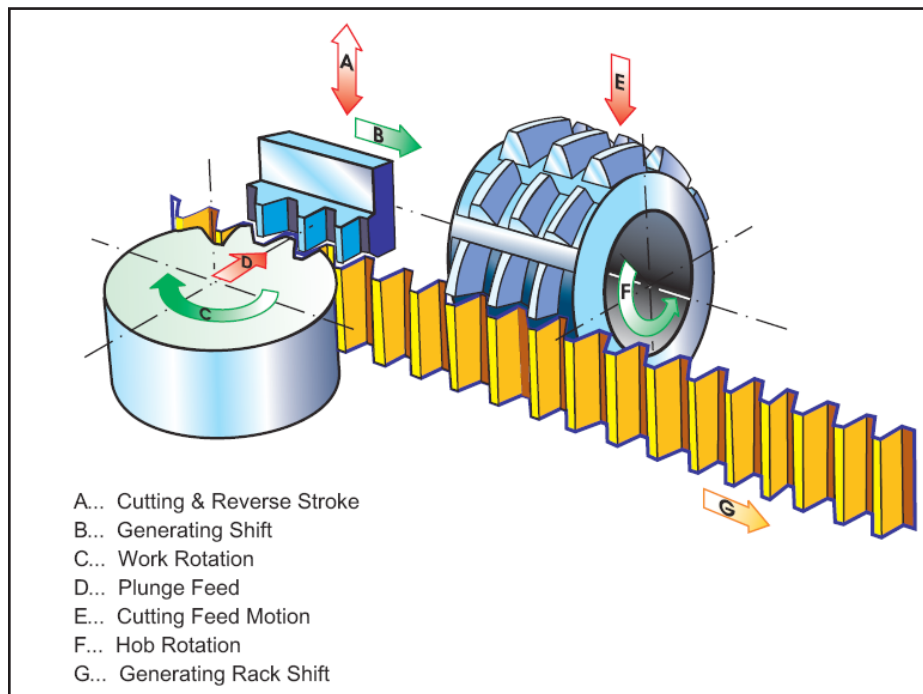

Figure 8 Manufacturing of involute tooth forms.

upper bevel gear to engage in a perfect meshing condition with the generating gear — and if the lower bevel gear can engage in a perfect meshing condition with the mirror-imaged bottom side of the generating gear — then the generating gear (which has only a virtual character) can be removed and the two bevel gears will mesh perfectly with each other as well. This leads to the formal definition of the kinematic coupling requirements.

### Kinematic Coupling Requirements

1. The flank surfaces of the generating gears of the two mating bevel gears are congruent (same shape but mirror images (Fig. 9))
2. The generating gears of the two mating bevel gears require identical axes of rotation (top/bottom sides of generating gear in Figure 9 form the same generating gear which rotates in both cases around the same axis and therefore satisfies condition 2)
3. The surface of engagement of pinion and ring gear must be identical to the surface of engagement between pinion and generating gear, and also to the one between ring gear and generating gear (without detailed knowledge of the surfaces of engagement, the global condition in Figure 9 seems to satisfy this requirement)

With all coupling requirements satisfied, the ring gear flanks are conjugate to the pinion flanks. (The term conjugate is used in mathematics for two or more surfaces which contact each other along a line. Since the 1980s the term conjugate is also employed in the gear technology literature to define the “exact” gear pair which presents a triple plurality of line contact between two gear flanks during the meshing process (Ref. 4). This book will apply this application of the term conjugate according to the following definition, since it is commonly used today.

### Definition of the Conjugate Gear Pair

1. The flanks contact along a line (contact line), which is only limited by the boundaries of the teeth, i.e. — the overlapped area
2. The line contact between the flanks exists within the entire area of engagement in every mesh position
3. Line contact is maintained in the entire area of engagement even if pinion and ring gear are rotated by angular incre-

ments as long as those increments exactly fulfill the transmission ratio

A functional and conjugate bevel gear set can be generated even if not all requirements from above are fulfilled. This will require the implementation of certain corrections. However, the robustness and stability of a certain design will be diminished when fewer of the kinematic coupling requirements are satisfied.

The violation of a coupling requirement and the resulting consequences to the functionality are not connected like binary conditions. An increasing deviation from a single requirement results in an increased limitation in the roll and transmission quality of a gearset.

When the involute flank generation of cylindrical gears was applied to bevel gears in Figure 9, the trapezoidal gener-

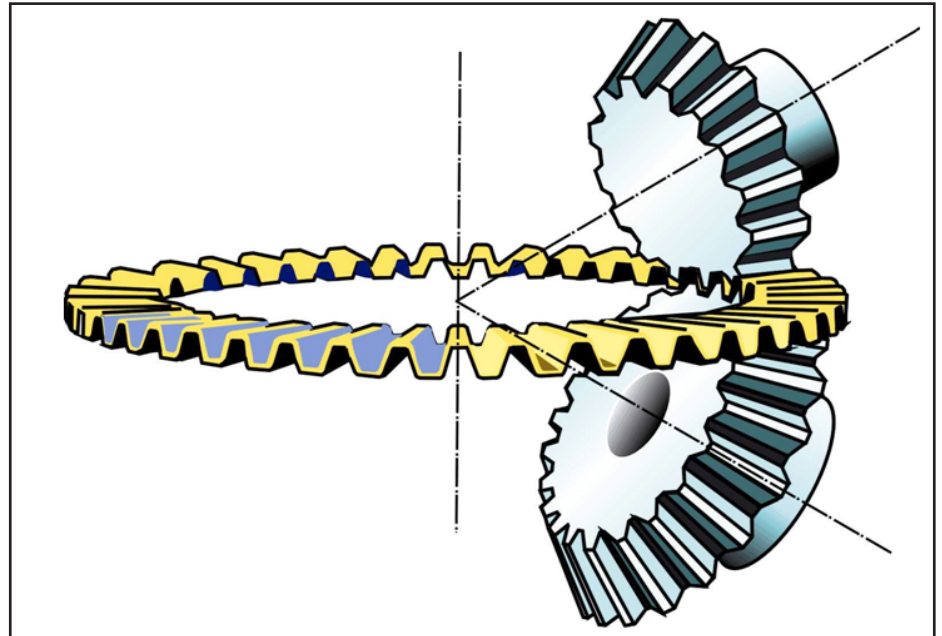

Figure 9 Generating principle of straight bevel gears.

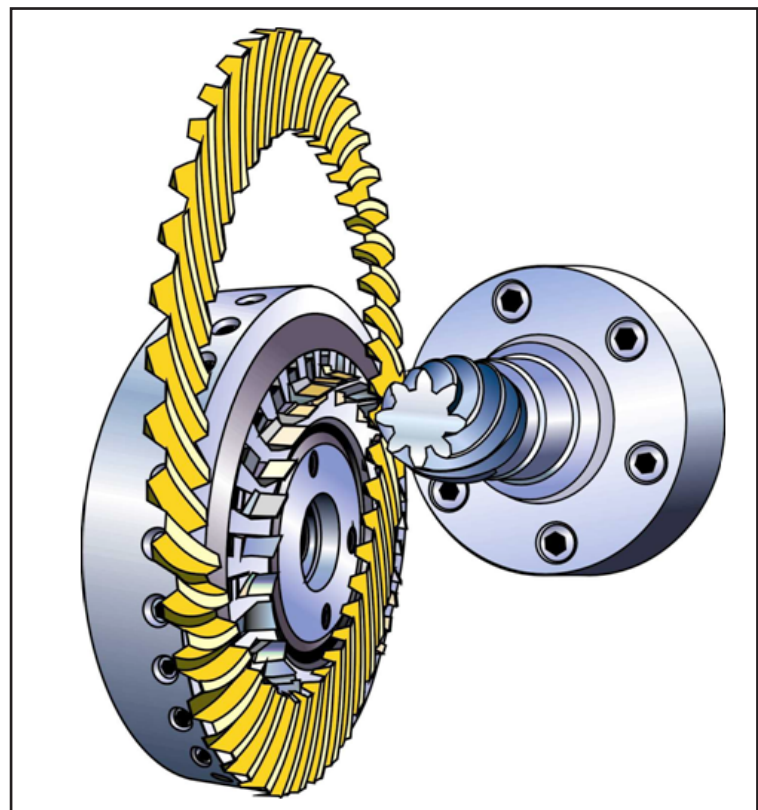

Figure 10 Generating principle of spiral bevel gears.

ating profile with plain “side walls” was used as the basis for the plain generating gear for straight bevel gears. The generating principle of conjugate flank pairs between pinion and ring gear works for a wide variety of flank length forms as long as certain rules are respected.

It is, for example, possible to expand the function of the straight tooth plain generating gear of Figure 9 to a plain generating gear with curved teeth and subsequently arrive at Figure 10. At the left side of the generating gear (Fig. 10), a cutter head is shown that has blades that are oriented a certain distance from the cutter head center, which represent one tooth of the generating gear. This arrangement allows for a continuous rotation of the cutter head that results in an efficient chip removal in the tooth slots. The teeth of the resulting spiral bevel gear are oriented under an angle to the radial orientation of the straight bevel gear teeth (Fig. 9). A radial section (with an axial plane) will cut through two or even more teeth. This means for the pinions and gears manufactured with the generating gear in Figure 10, that more than one pair of teeth is in mesh and participates in the transmission at any time. This effect, called the “modified

contact ratio,” results in larger transmittable torques and a smoother rolling of the flanks.

An intuitive justification of the step from straight teeth to curved teeth is demonstrated in Figure 11. The straight teeth to the left (Fig. 11, top) are divided into more and more segments; the segments are then rotated along the face width from left to right. An infinite number of segments with infinitesimally small rotations deliver eventually the spiral bevel teeth (right, Fig. 11, top). The definition of the spiral angle is demonstrated in the lower part of the same figure (the drawing plane is equal to the generating plane). The rules regarding the shape of the flank line curves (and pressure angle) that have to be followed in order to assure undisturbed meshing will be summarized in the second half of this chapter, which will appear in the next issue of *Gear Technology*. The second half also delves into more detail with regard to the different methods of generating bevel gear teeth.

**Summary**

- At the beginning of this chapter some thoughts about plausible explanations of the gearing law were discussed.

- Involute gearing was then presented as the consequential result of the engineering demand for a robustly functioning, easy-to-manufacture tooth form.

**References**

1. Buckingham, E. *Spur Gears*, McGraw-Hill Book Company, Inc., New York and London 1928.
2. Niemann, G. and H. Winter. *Maschinenelemente I, II & III*, Springer-Verlag Berlin, Heidelberg, New York, Tokyo, 1983.
3. Dudley, D. *Dudley's Gear Handbook*, McGraw-Hill, Inc. New York 1991.
4. Schriefer, H. “Verzahnungsgeometrie und Laufverhalten bogenverzahnter Kegelradgetriebe,” Dissertation, RWTH Aachen, 1983.
5. Stadtfeld, H.J. “Anforderungsgerechte Auslegung bogenverzahnter Kegel-Radgetriebe,” Dissertation, RWTH Aachen, 1987.
6. Brandner, G. “Kreisbogenverzahnte Kegelräder,” *Maschinenbautechnik*, 3. Jg. Issue 5 May 1954.
7. Richter, E.H. “Geometrische Grundlagen der Kreisbogenverzahnung und ihre Herstellung,” *Konstruktion*, Issue 3, 1958.

**Gleason Bevel Gear Technology can be purchased (\$68; 50% student discount) via the Gleason Website by clicking “About Gleason” – followed by “Gleason Company Store” – and then “Promotional Items.”**

For Related Articles Search  
**basics**  
 at [www.geartechnology.com](http://www.geartechnology.com)

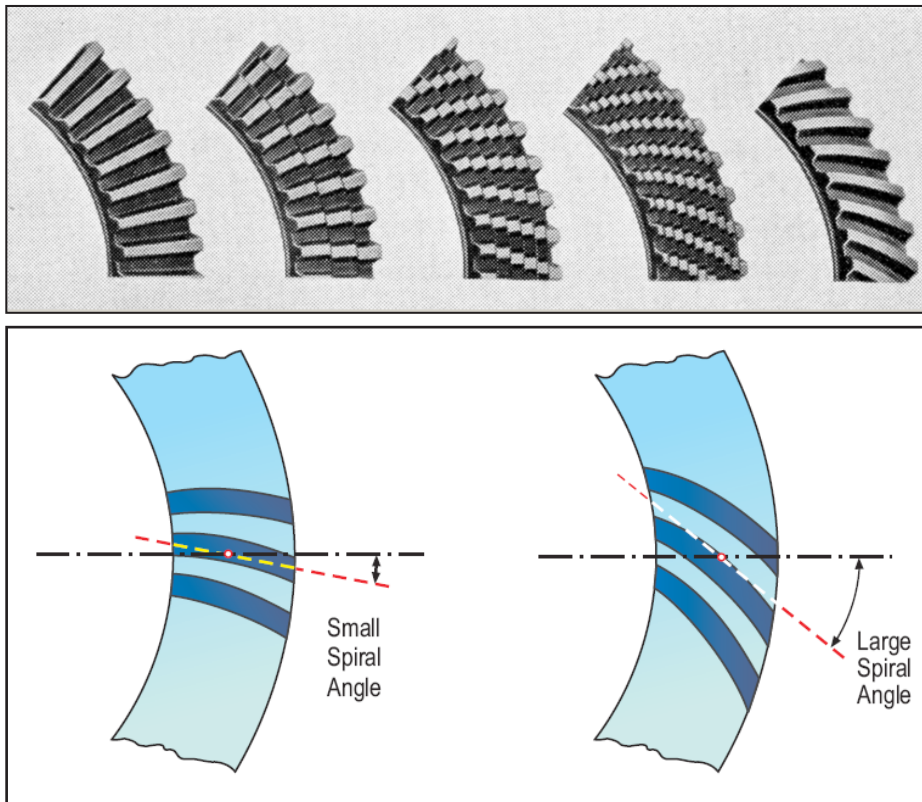

**Figure 11 Model for creation of curved teeth and explanation of spiral angle.**

**Dr. Hermann J. Stadtfeld**

received in 1978 his B.S. and in 1982 his M.S. degrees in mechanical engineering at the Technical University in Aachen, Germany; upon receiving his Doctorate, he remained as a research scientist at the University's Machine Tool Laboratory. In 1987, he accepted the position of head of engineering and R&D of the Bevel Gear Machine Tool Division of Oerlikon Buehrle AG in Zurich and, in 1992, returned to academia as visiting professor at the Rochester Institute of Technology. Dr. Stadtfeld returned to the commercial workplace in 1994—joining The Gleason Works—also in Rochester—first as director of R&D, and, in 1996, as vice president R&D. During a three-year hiatus (2002-2005) from Gleason, he established a gear research company in Germany while simultaneously accepting a professorship to teach gear technology courses at the University of Ilmenau. Stadtfeld subsequently returned to the Gleason Corporation in 2005, where he currently holds the position of vice president, bevel gear technology and R&D. A prolific author (and frequent contributor to *Gear Technology*), Dr. Stadtfeld has published more than 200 technical papers and 10 books on bevel gear technology; he also controls more than 50 international patents on gear design, gear process, tools and machinery.





# COBO HALL

DETROIT, MICHIGAN

October 20 & 21, 2015

*Gear Technology* Presents

## ASK-THE-EXPERT LIVE!

An All-Star Review, Featuring Some of the  
TOP NAMES in Gear Technology.

Bring your toughest gear manufacturing  
questions and get the answers, LIVE on the  
show floor:

- **Cutting Tools**
- **Bevel Gears**
- **Gear Design**
- **Inspection**

And much, much more...

**Booth # 2030, Gear Expo  
Cobo Hall, Detroit Michigan**



**gear**  
TECHNOLOGY

NO SEATS RESERVED

# Test Facility Simulation Results for Aerospace Loss-of-Lubrication of Spur Gears

Robert F. Handschuh and Lucas J. Gargano

Prior to receiving airworthiness certification, extensive testing is required during the development of rotary wing aircraft drive systems. Many of these tests are conducted to demonstrate the drive system's ability to operate at extreme conditions, i.e. — beyond that called for in the normal to maximum power operating range.

One of the most extreme tests is referred to as the “loss-of-lubrication” or “run dry” test.

Failure of this test can lead to a partial redesign of the drive system or the addition of an emergency lubrication system. Either of these solutions can greatly increase the aircraft drive system cost and weight — and extend the schedule for obtaining airworthiness certification. Recent work at NASA Glenn Research Center (Cleveland, OH) focused on performing tests in a relevant aerospace environment in order to simulate the behavior of spur gears under loss-of-lubrication conditions. Recent testing has focused on newer aerospace gear steels and imbedding thermocouples in the shrouding to measure the air/oil temperatures flung off the gear teeth.

Along with the instrumented shrouding, an instrumented spur gear was also tested.

The data from these two types of measurements provided important information as to the thermal environment during the loss-of-lubrication event. This data is necessary to validate ongoing modeling efforts.

## Background, Introduction

As mentioned, the drive system used in rotorcraft applications is required to pass a 30-minute loss-of-lubrication test prior to aircraft certification. This means that the drive system must continue to operate for 30 minutes with the primary lubrication system inoperative (Ref. 1). To achieve this capability, gears become extremely susceptible to failure due to a starved lubrication condition. High load, high pitch line velocity — or the combination of both — can cause the gears, due to the meshing process, to heat to the point of failing.

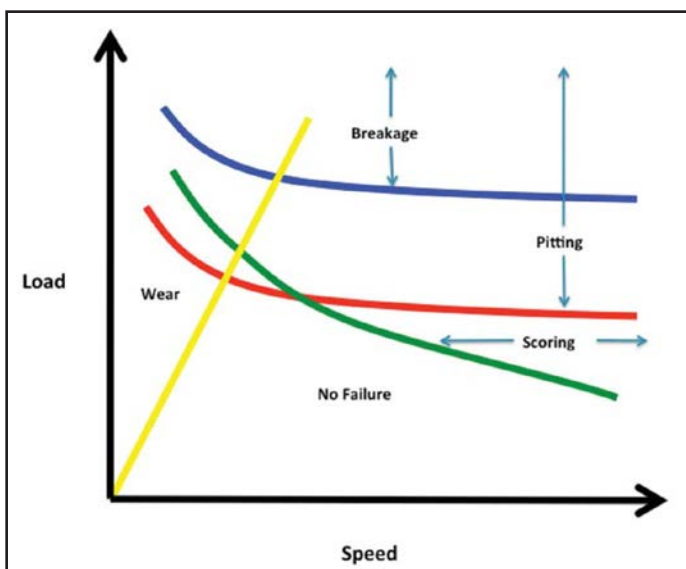

Figure 1 Effects of speed and load on gear wear mechanisms.

Failure mechanisms of gear contacts are summarized in Figure 1 (Ref. 2). Here, two of the mechanisms are of most importance for loss-of-lubrication; the first is the wear region where extreme loading at slower sliding speeds under starved lubrication conditions generates sufficient heat to expedite wear; the other region is the scoring region where high relative sliding of the teeth influences the heat being generated. In either case the friction coefficient increases due to the loss of the full elasto-hydrodynamic fluid film — thus increasing the heat generation rate.

Recent studies (Refs. 3–5) made initial attempts at evaluating the loss-of-lubrication behavior of tested components typically used at NASA Glenn for contact fatigue studies. In prior and current NASA testing, all tests were run in a dry-sump manor, where all lubrication is jet-fed and gravity-drained. This type of lubrication system results in efficient operation of the drive system and is the lubrication mode typical in all rotorcraft main transmissions.

In these prior tests many aspects were considered, including run-dry conditions, vapor-mist lubrication, grease lubrication, test gearbox drainage, and shrouding. These results indicated that testing in a relevant environment was essential for the generation of useful results; therefore the current test arrangement evolved to represent an aerospace environment. Gear shrouding was used in all tests conducted in this paper.

The test results described in this paper document the ongoing research assessment of aerospace-quality components subjected to loss-of-lubrication conditions. Static instrumentation located in the gear shrouding was used on all tests. Also, one test gear was instrumented with thermocouples to provide temperature

data on the gear. This gear was subjected to normal and loss-of-lubrication conditions. Results from these tests are described in this report.

## Test Facility

The test facility used for conducting all loss-of-lubrication simulation tests is the NASA Glenn contact fatigue test facility (Refs. 6–8) (Fig. 2). The facility is a torque regenerative test rig that locks torque in the loop via rotating torque applicier. The test gears have a 1:1 ratio. Facility speed and torque can be varied as needed during a test. The basic gear design information of the tested gears is listed in Table 1.

Table 1 Basic gear design information	
	28 tooth gear
Module, mm [diametral pitch (1/in.)]	3.175 (8)
Pressure angle (deg.)	20
Pitch diameter, mm (in.)	88.9 (3.5)
Addendum, mm (in.)	3.175 (0.125)
Whole depth, mm (in.)	7.14 (0.281)
Chordal tooth thickness, mm (in.)	4.85(0.191)
Face width, mm (in.)	6.35 (0.25)

As previously mentioned, the facility went through an evolutionary period (Ref. 5) where shrouding, visual access, gearbox lubricant removal, and instrumentation were added to the test section. A photograph of the current test gearbox arrangement is shown in Figure 3.

Static shroud thermocouples were utilized during all tests. High-temperature glass was also utilized as the outside shroud to encase the gears. Ballistic plastic and another layer of high-temperature glass provided visual (and video) access to the gears during operation. Lubricant for normal operation was fed at the into-mesh location through part of the shroud (Fig. 4). The normal operational flow rate was approximately 0.42 l/min (0.11 gpm), at 207 kPa (30 psig) jet pressure, with the lubricant inlet temperature of ~110°C (230°F). Instrumentation and normal lubricant jet locations are shown (Fig. 4). A turbine engine with drive system lubricant MIL-L-85734 was used during the testing at hand.

## Testing Methodology

Prior to the reported loss-of-lubrication testing, the gears were broken-in to allow normal run-in wear to occur. The gears were operated for at least 1 hour at ~50 percent maximum torque and at full facility speed (10,000 rpm). After this period the load was then increased to the maximum load and run for at least several more hours prior to conducting a loss-of-lubrication test. Most tests were run until the teeth failed to continue to carry torque (plastically deformed), or were stopped just prior to this condition.

During all tests the static instrumentation and live video were carefully monitored. Data from all sensors were collected at 1 Hz and stored for post-processing.

## Testing and Discussion of Results

The test results described in this report were from the same lot of gears manufactured to the basic gear design information provided in Table 1. The gear material was an aerospace gear steel (Ref. 9) that was carburized and final-ground; the surface roughness was 0.41 micro-meters (16 micro-inch) or better. The

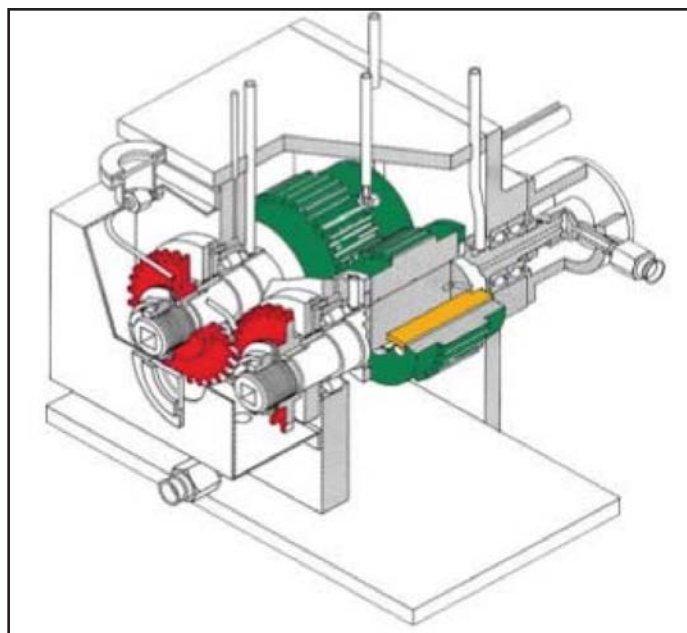

Figure 2 Cross-sectional sketch of the test gearbox used for loss-of-lubrication testing.

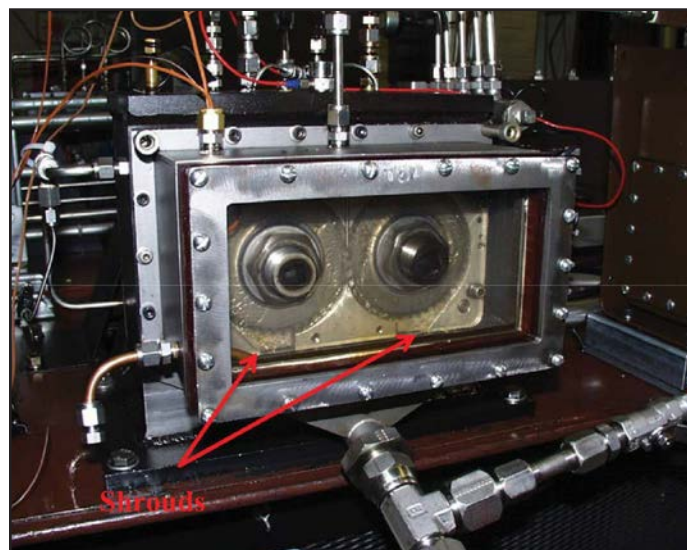

Figure 3 Current test gearbox arrangement utilizing shrouds (bottom exit shown).

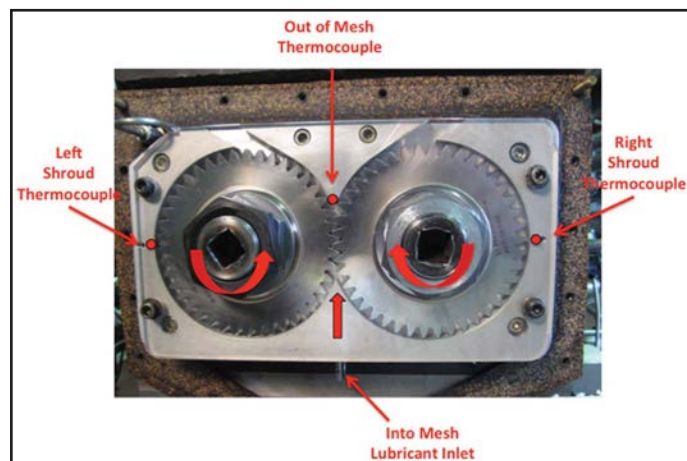

Figure 4 Example of test gear arrangement with outer gearbox cover removed, top exit shrouds shown.

gears have some tip relief starting at the highest point of single-tooth contact and a small amount of crowning across the face width that is symmetric.

Five test results are described in this report. The tests in the loss-of-lubrication condition were conducted at one of two load levels, and are documented in Table 2. The basic gear design information, along with the load level, produced maximum levels of bending and contact stress, found via the analysis technique in Reference 10.

An example of each of the two load levels will now be described.

Torque	Maximum contact stress	Maximum bending stress
N*m (in*lb)	GPa (ksi)	GPa (ksi)
59.3 (525)	1.67 (242)	0.214 (30.9)
83.6 (740)	1.88 (272)	0.296 (43)

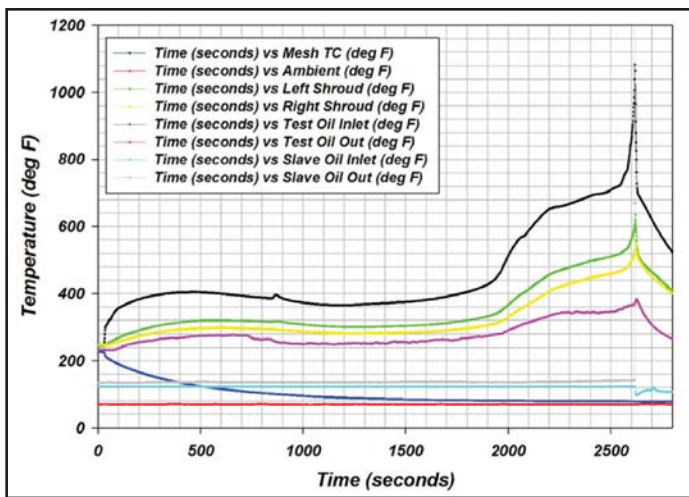

**Figure 5** LOL (loss of lubrication) data for 1.72 kPa (250 psi) load pressure ~ 59.3 N\*m (540 in\*lb) torque tested at 10,000 rpm.

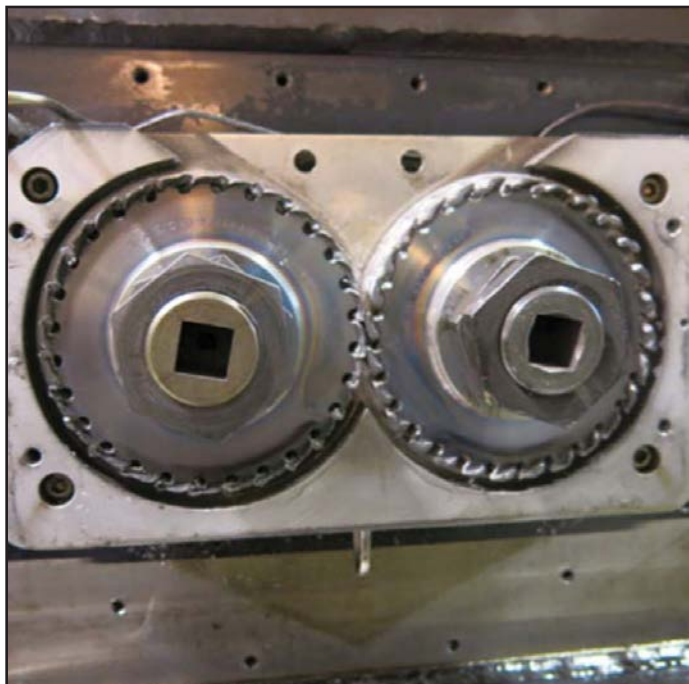

**Figure 6** Post-test condition of the gears (gearbox cover and outer high-temperature glass removed).

At the lower level of the two loads, two tests were conducted with the loss-of-lubrication time of 40.8 and 43.1 min in length. The data from the static thermocouples imbedded in the shrouds, along with other facility temperatures, is shown in Figure 5.

The gears in the post-test condition are shown in Figure 6. Note that the test was conducted until the gear tooth meshing heat generation and resultant temperature were high enough to plastically deform the gear teeth. This type of post-test condition occurred whenever the test was permitted to continue until total loss-of-torque-delivery was achieved; a typical loss-of-lubrication failure at this condition is shown (Fig. 7).

Two other tests were conducted at an elevated level of load, i.e. — ~83.6 N\*m (740 in\*lb). These tests, in the loss-of-lubrication mode, produced failures in 7.9 and 9.2 minutes. The test temperature data from the 7.9-minute loss-of-lubrication test is shown (Fig. 8). As can be seen from this data, the temperature did not reach an increased steady-state condition prior to increasing to failure, as it did in the test shown in Figure 5. After the primary lubrication system was disconnected, the temperature just continued to rise. The post-test condition of the test gears is shown (Fig. 9) with the gearbox cover removed.

**Instrumented Gear Test**

The most desired test for loss-of-lubrication behavior includes employing on-component information. While it would be of great benefit to have instrumentation at the gear-meshing sur-

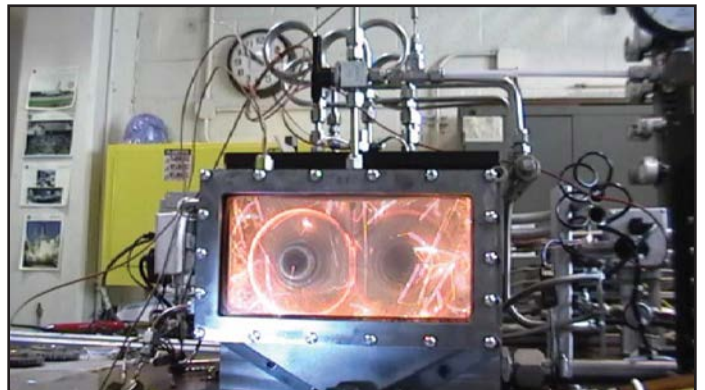

**Figure 7** Example of loss-of-lubrication test during final seconds of operation.

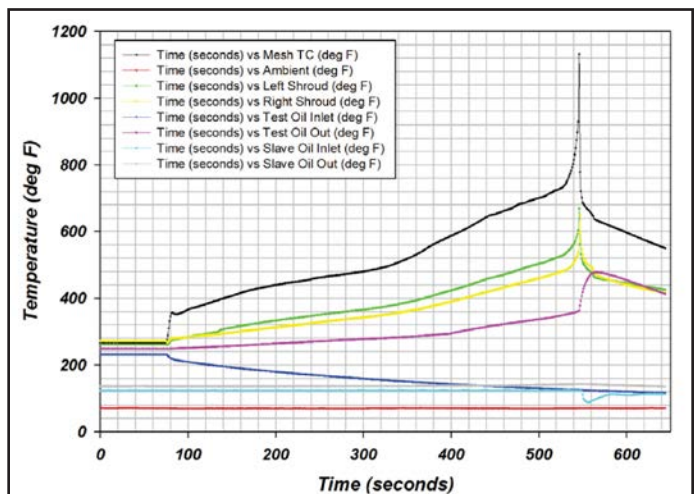

**Figure 8** Loss-of-lubrication data from higher load test 83.6 N\*m (740 in\*lb).

face, this has been shown to be very difficult to accomplish. Even with full elastohydrodynamic film, the lubricant viscosity of turbine engine lubricants — as used in rotorcraft drive systems — is insufficient to develop films thick enough to keep the on-surface instrumentation from wearing away. Therefore thermocouples were installed at locations in areas of the gear where contact does not occur.

The gear used in these tests is shown (Fig. 10); it is the gear that was installed in the left side of the gearbox. The left-side gear acts as the driving gear of the test section of the facility. A total of five thermocouples were attached to the gear at: the tooth tip mid-face width; root mid-face width; on the side of the gear at the pitch radius; root radius; and mid-web locations. As shown (Fig. 10), the thermocouple wires were covered by a thin metal foil that was spot-welded to the side of the gear to protect the instrumentation during operation. The rest of the required

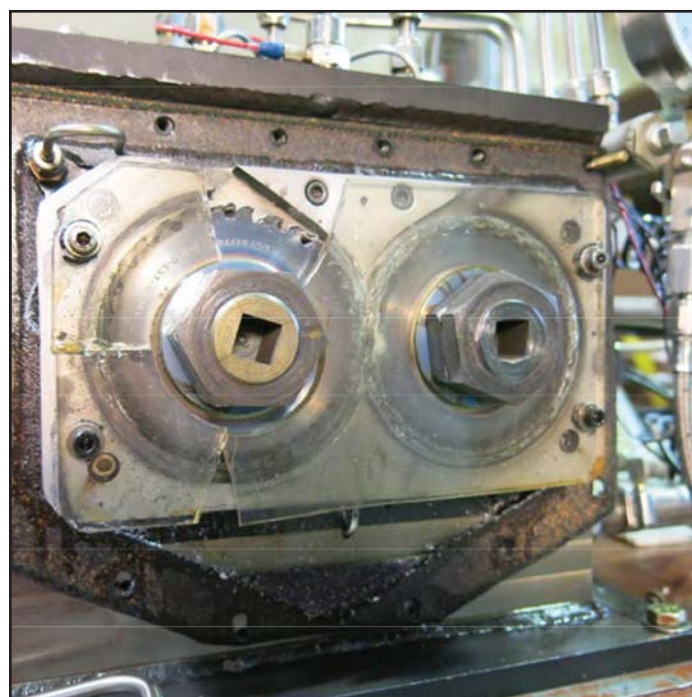

Figure 9 Post-test photograph of increased load test gears with outer shroud high-temperature glass fractured.

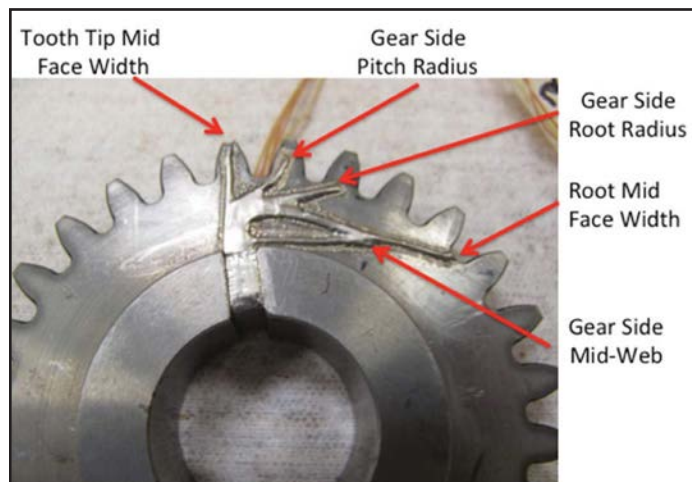

Figure 10 Instrumented LOL test specimen before testing.

hardware is shown (Fig. 11) prior to installation in the test rig; the assembly in the test rig is shown (Fig. 12).

The initial data for warm-up and operation of the facility in the normal-to-loss-of-lubrication mode is shown (Fig. 13).



Figure 11 Loss-of-lubrication test specimen and related components.



Figure 12 Test set-up for instrumented test gear.

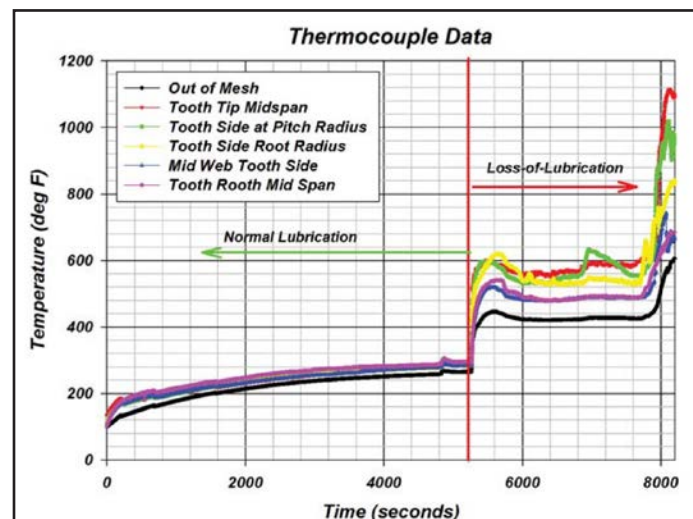

Figure 13 On-gear and out-of-mesh thermocouple data from start-up to instrumentation failure during loss-of-lubrication.

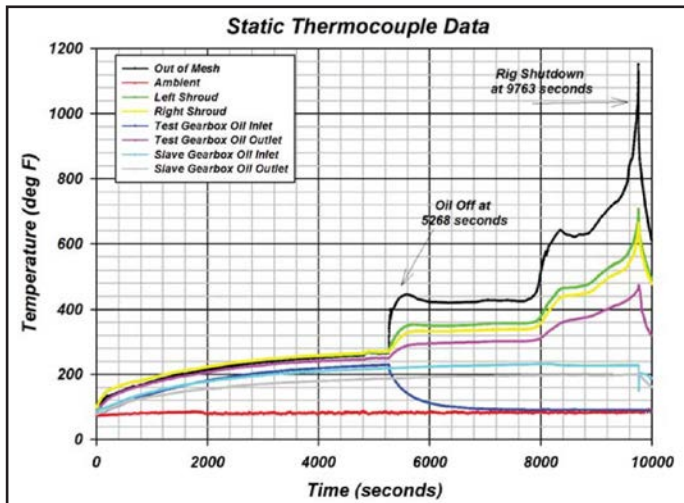

Figure 14 Data from shroud and facility (static) thermocouples.

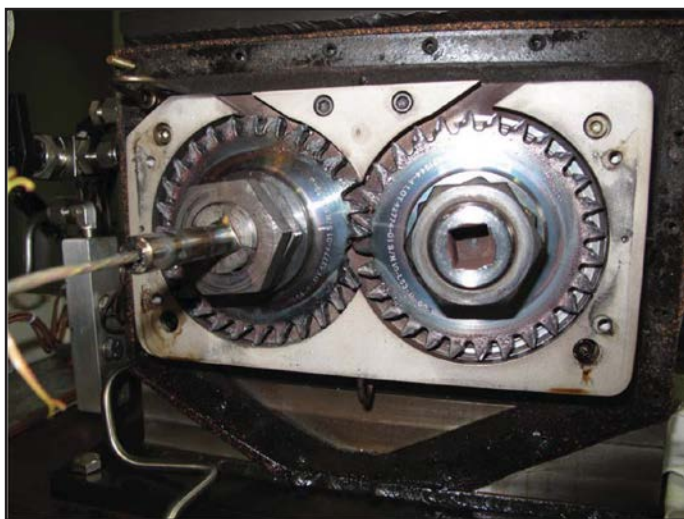

Figure 15 Post-test condition after loss-of-lubrication test was completed. Gearbox housing, slip ring and outer high temperature glass removed.

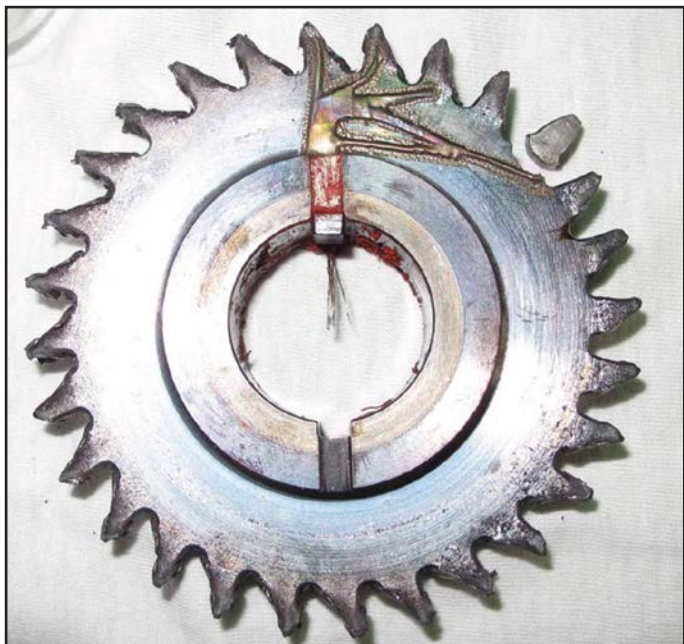

Figure 16 Instrumented spur gear post-loss-of-lubrication test condition.

During this same test the lubricant was shut off and the test run until failure. The data from loss-of-lubrication initiation to failure for the shroud (static) and other facility thermocouples is shown (Fig. 14).

The data in Figures 13 and 14 indicate that the bulk temperatures of the gear were exceeding the temperature that was found from the static shroud thermocouples. In the normal lubrication condition this value was 20 to 40°F—depending on the location. In loss-of-lubrication mode this amount was as much as 500°F higher on the gear than that of the static shroud thermocouples. In Figure 13 the data beyond 8,200" is believed to be invalid due to post-test inspection of the thermocouple wiring that was melted together at the common locations through the shaft. The thermocouple wiring coating was exposed to bulk temperatures in the gear beyond the melting point of the wire coating.

The post-test condition of the gears used in this test is shown (Fig. 15). What can be noted is that a bending failure occurred before the loss-of-lubrication test—as the failed tooth has no evidence of running in this post-test condition. A hypothesis is that tooth failure was initiated by a spot-weld in the root fillet region from the thin metal protection strap that was used to cover the thermocouple wiring.

In Figure 16 the tooth that failed in bending shows no apparent damage from loss-of-lubrication, since it occurred before this lubrication condition was initiated. Upon closer examination, the thin metal strapping used to overcoat the wiring that was spot-welded to the tooth was found to be the initiation site of the bending failure. Future testing of hardware for this purpose will not have this as a hold-down feature for the tooth root-fillet area.

### Conclusions

A series of five loss-of-lubrication tests were conducted in an aerospace-simulated environment using consistent sets of test hardware. Following is a summary of the test results:

Applied torque can have a drastic effect on loss-of-lubrication time. An increase of torque by 40%, 59.3 to 83.6 N\*m (525 to 740 in.-lbs), resulted in a decrease in loss-of-lubrication operation time by 75% (42 to 8 min).

Operation in loss-of-lubrication mode at lower torque produced an elevated steady-state temperature condition. The higher torque level did not have this operating time at an elevated steady-state temperature condition. During the higher torque tests the temperature continued to increase until failure of the teeth.

On-component thermocouple data revealed that the gears under normal conditions have bulk temperatures that are 20 to 40°F higher than the fling-off temperatures measured by the static shroud thermocouples.

On-component thermocouple data indicated that during loss-of-lubrication, conditions bulk temperatures on the gear are from 150° to 500°F higher at certain times during this test mode, when compared to the static shroud temperatures.

## References

1. ADS-50-PRE. "Aeronautical Design Standard, Rotorcraft Propulsion Performance and Qualification Requirements and Guidelines," U. S. Army Aviation Troop Command, April 1996.
2. Handschuh, R. "Thermal Behavior of Spiral Bevel Gears," NASA-TM-106518, ARL-TR-403, January 1995.
3. Morales, W. and R. Handschuh. "A Preliminary Study on the Vapor/Mist Phase Lubrication of a Spur Gearbox," NASA TM-1999-208833, February 1999.
4. Morales, W., R. Handschuh and T. Krantz. "Feasibility Study of Vapor-Mist Phase Reaction Lubrication Using a Thioether Liquid," NASA/TM—2007-215035, December 2007.
5. Handschuh, R., J. Polly and W. Morales. "Gear Mesh Loss-of-Lubrication Experiments and Analytical Simulation," NASA/TM—2011-217106, November 2011.
6. Oswald, F. "Mechanical Components Branch Test Facilities and Capabilities," NASA/TM—2004-212722, January 2004.
7. Krantz, T. and A. Kahraman. "An Experimental Investigation of the Influence of the Lubricant Viscosity and Additives on Gear Wear," NASA/TM—2005-213956, ARL-TR-3126, October 2005.
8. Krantz, T. "The Influence of Roughness on Gear Surface Fatigue," NASA/TM—2005-213958, October, 2005.
9. Pyrowear Alloy 53. Carpenter Technology Corporation, AMS 6308B.
10. Vijayakar, S. and S. Abad. *Helical 3-D User's Manual*, Advanced Numerical Solutions, Hilliard, OH, February 2005.

**Dr. Robert F. Handschuh** has over 30 years of experience with NASA and Department of Defense rotorcraft drive system analysis and experimental methods. He has served as the Drive Systems team leader for the Tribology & Mechanical Components Branch at NASA Glenn Research Center in Cleveland, Ohio for over 15 years, and currently leads the research there in high-speed gearing, including windage, loss-of-lubrication technology, and hybrid gearing. Handschuh is credited with successfully developing many experimental research test facilities at Glenn, and has conducted testing in the following areas: high-temperature, ceramic seal erosion; blade-shroud seal rub; planetary geartrains; spiral bevel gears and face gears; high-speed, helical geartrains; single-tooth-bending fatigue; and high-speed gear windage.



**Lucas J. Gargano** is a NASA Glenn Research Center LERCIP intern.

# FEELING SOCIAL?

Interact with your Gear Industry peers  
at [www.geartechnology.com](http://www.geartechnology.com).



- Gear Technology blog
- Ask the Expert
- Follow us on Twitter
- Join the Gear Technology group on LinkedIn (1,100 members and growing!)



Follow us on Twitter  
[twitter.com/#!/Gear\\_Technology](https://twitter.com/#!/Gear_Technology)



Connect with us on LinkedIn  
[www.linkedin.com/groups/Gear-Technology-Magazine-3893880](http://www.linkedin.com/groups/Gear-Technology-Magazine-3893880)



Subscribe Online  
[www.geartechnology.com/subscribe.htm](http://www.geartechnology.com/subscribe.htm)

# Optimal Modifications on Helical Gears for Good Load Distribution and Minimal Wear

Christoph Lohmann, Matthias Walkowiak and Peter Johannes Tenberge

Helical gear teeth are affected by cratering wear—particularly in the regions of low oil film thicknesses, high flank pressures and high sliding speeds. The greatest wear occurs on the pinion—in the area of negative specific sliding. Here the tooth tip radius of the driven gear makes contact with the flank of the driving gear with maximum sliding speed and pressure. In order to understand this phenomenon more precisely, a wear simulation model is presented. Based on an accurate meshing simulation—used to determine the correct path-of-contact by considering tip relief and wear—pressure distribution, sliding speeds and oil film thicknesses across contact lines are calculated. Thus local wear on the teeth of pinion and wheel is calculated via consideration of their roughness. A verification of the model is presented by a comparison of the simulation results with experimental results. Furthermore, a crack criterion to determine critical surface areas regarding micropitting and pitting is presented.

## Introduction

Gears can fail due to various damage patterns. Especially in view of the tooth flank fatigue damage such as micropitting or pitting, it is important to be able to recognize and predict the fatigue time. Micropitting starts with fine cracks and small out-breaks on the surface of the flank. It can progressively develop to a cratering wear. Thus, the load capacity of the tooth flank is reduced, additional dynamic loads are arisen and the gear box gets a higher noise level. For a better description of the micropitting area and the wear rate it is necessary to specify the local complex tribological system of the tooth flank.

Experimental results which are presented in Figure 1 have shown that different profile modifications have influence on the micropitting and the wear rate. The commercial calculations accordance to ISO/TR 15144-1 (Ref. 1) does not exactly show the influence of the profile modifications. An optimal modification based on a cubical tip relief with an additional big tooth tip radius causes a smaller micropitting area and wear rate as a modification without a tooth tip radius (Fig. 1). Therefore, the pressure peaks in the first contact area smaller and the risk of the fatigue damage are also smaller.

The meshing engagement of a pair of teeth of a spur gear begins with a first contact of the newly engaging teeth in a contact of the tooth tip radius of the driven gear on the flank of the driving tooth. Meanwhile another pair of teeth is already engaged. In this regard, as the new pair of teeth gets more and more load, the amount of load of the already meshing pair of teeth decreases. In order to take this process accurately into consideration, a precise computation of the path of contact is required. Therewith, the areas of first and last contact starting and leaving the contact at a contact force of zero are consid-

ered within a load computation. In case a tip relief and a radius among the flank and head diameter being applied on the teeth, the path of contact differs significantly from the theoretical path of contact of an involute gear without any modifications and sharp edges. The correct path of contact for an improved computation of the load distribution results from a meshing simulation of the actual tooth flanks by taking tooth corrections and wear into consideration. Herewith, it is possible to determine the influence of tip reliefs and tooth tip radii on the load and pressure distribution across the tooth flank, especially in the area of first and last contact, more precise than today.

Based on the local flank pressures, sliding speeds and oil film thicknesses, cratering wear occurs on the teeth of spur gears. Thereby cratering wear occurs especially on the pinion in the area beneath the pitch point where the tooth tip radius of the driven gear gets into contact at a maximum of sliding speed. By taking all the physically relevant parameters into account such a wear mechanism can be computed so that the increase of wear on the tooth flanks can be simulated.

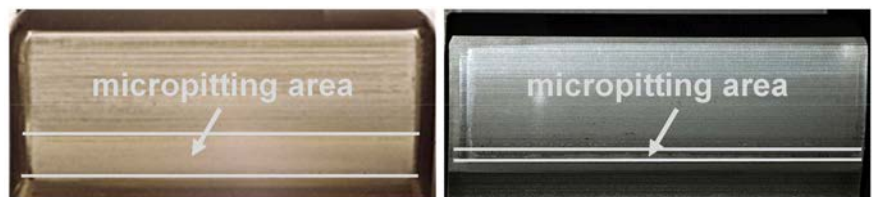

Figure 1 Tooth flanks with micropitting: a) linear tip relief of ca=170 μm without an additional tooth tip radius; b) linear tip relief of ca=170 μm with an additional tooth tip radius.

## Meshing Simulation: Actual Path of Contact

Based on the manufacturing process it is possible to obtain the equations describing the theoretical involute spline of a pinion and a gear wheel within the coordinate system in Figure 2.



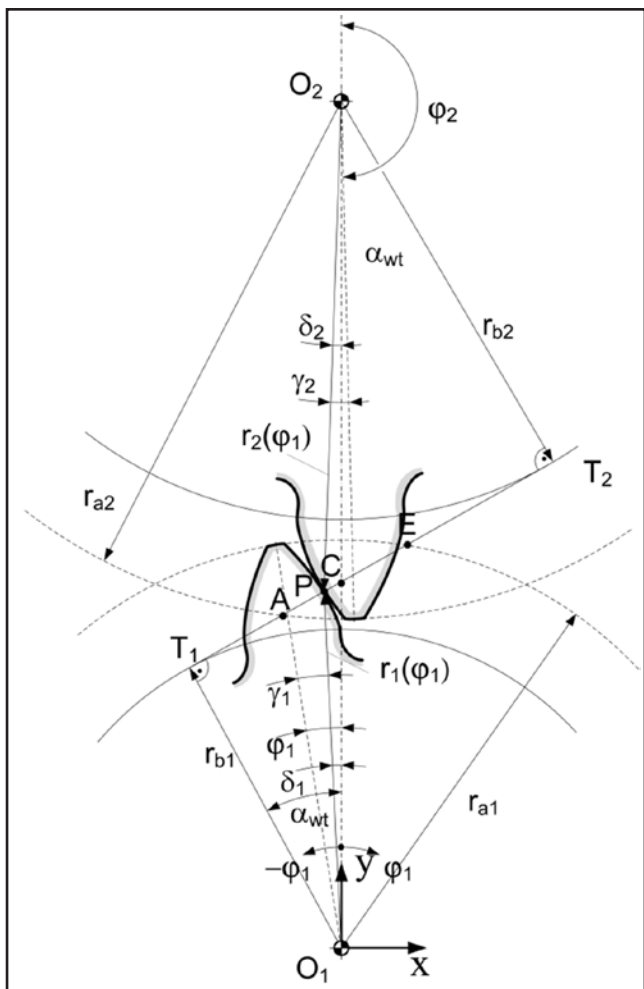

Figure 2 Random position in meshing simulation.

With a meshing simulation the contact points of the pinion and the gear wheel can be found and a line of action can be calculated. The meshing engagement of a pair of teeth of a pinion and a gear wheel begins with a first deflection of the newly-engaging teeth in a contact of the head-edge of the driven tooth on the flank of the driving tooth, while another pair of teeth is already engaged. In that extend as the new pair of teeth gets more and more load, the load on the already meshing tooth pair decreases until it is fully released and tops out.

To calculate this process correctly within a load distribution computation, it requires a precise extension of the line of action up to these areas of first getting in contact at a contact force of zero and leaving the contact at a contact force of again zero. If the teeth have a tip relief and a radius between flank and head-diameter this line of action differs significantly from the theoretical line of action of an involute gear. The correct line of action for an improved load distribution calculation results from a meshing simulation of the actual tooth flanks from the foot-radius beyond the tip radius.

Then it is possible to calculate the influence of different tip reliefs and tip radii on the load distribution on the teeth as well as the pressure distribution.

Therewith, an accurate detection of the point of the first and last contact of gear pairs with profile modifications and cratering wear is possible.

## Load Distribution: Local Pressure Distribution

Once the path of contact is derived within a meshing simulation, the load distribution across the contact lines can be computed for a certain number of engagement positions by using contact influence figures (Ref. 5). If the tooth profile has profile corrections or wear, the contact normal forces are not rectified and parallel anymore. This has got to be taken into consideration while formulating the load conservation equation. For a certain amount  $m$  of teeth in contact, discretized with a specified number of contact-points  $n$ , the discrete load conservation equation arises to Equation 1:

$$T_{ges} = \sum_{i=1}^m \sum_{k=1}^n r_{w,i,k} F'_{n,i,k} \quad (1)$$

By knowing the parameterized tooth profile, the effective radius  $r_w$  arises to Equation 2:

$$r_{w,i,k}(r_{y,i,k}) = r_{y,i,k} \cos \left( \arctan \left( -\frac{dx_{evo,kor}(r_{y,i,k})}{dy_{evo,kor}(r_{y,i,k})} \right) + \arctan \left( -\frac{x_{evo,kor}(r_{y,i,k})}{y_{evo,kor}(r_{y,i,k})} \right) \right) \quad (2)$$

Because of the fact, that the contact area as well as the load distribution across the contact line and therewith the local Hertzian deformation is unknown, the contact problem has to be solved within an iterative process.

Resulting from the parameterized profile, the local radius of curvature arises to Equation 3, taking profile corrections and wear into consideration. Based on the local radius of curvature:

$$\rho_{1/2}(r_{y,i,k}) = \frac{[x'_{evo,kor}(r_{y,i,k})^2 + y'_{evo,kor}(r_{y,i,k})^2]^{3/2}}{|x'_{evo,kor}(r_{y,i,k})y''_{evo,kor}(r_{y,i,k}) - x''_{evo,kor}(r_{y,i,k})y'_{evo,kor}(r_{y,i,k})|} \quad (3)$$

the load distribution resulting from Equation 1 across the path of contact and material constants, the local Hertz contact pressure results from Equation 4:

$$p_{H,i,k} = \sqrt{\frac{F_{i,k}}{\Delta l} \frac{1}{\rho_{i,k}} \frac{1}{\pi \left( \frac{1-v_1^2}{E_1} + \frac{1-v_2^2}{E_2} \right)}} \quad (4)$$

$$\rho_{i,k} = \frac{\rho_{1,i,k} \rho_{2,i,k}}{\rho_{1,i,k} + \rho_{2,i,k}} \quad (5)$$

## Wear-Simulation

Wear on tooth flanks occurs as a result of high sliding speeds, high contact pressure and low oil film thicknesses. Assuming unlimited oil supply and neglecting thermal influences, the local oil film thickness can be computed using Equation 6 with regard to Dowson (Ref. 6), where  $G$  is a material coefficient;  $U$  a velocity coefficient;  $W$  a load coefficient; and  $\rho$  the replacement radius of curvature obtained by Equation 5:

$$h_{min} = 2,65 \frac{G^{0,54} U^{0,7}}{W^{0,13}} \rho \quad (6)$$

On the basis of accurate local contact pressures, sliding speeds, specific sliding, local oil film thickness and material hardness, an empirical equation for wear on tooth flanks — such as Equation 7 — can be formulated in accordance with Archard and Holm (Refs. 6, 7, 18):

$$\frac{dW}{dN} = k_s \cdot k_w \left( \frac{p_H}{2000 \text{ MPa}} \right)^\alpha \left( \frac{|v_g|}{2 \text{ m/s}} \right)^\beta \quad (7)$$

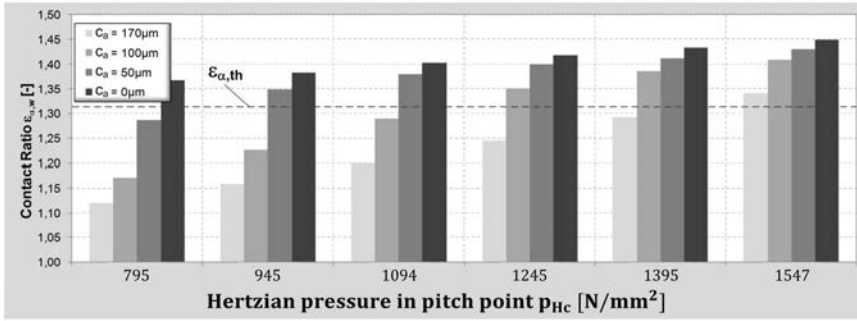

Figure 3 Contact ratio—different profile relief—without wear.

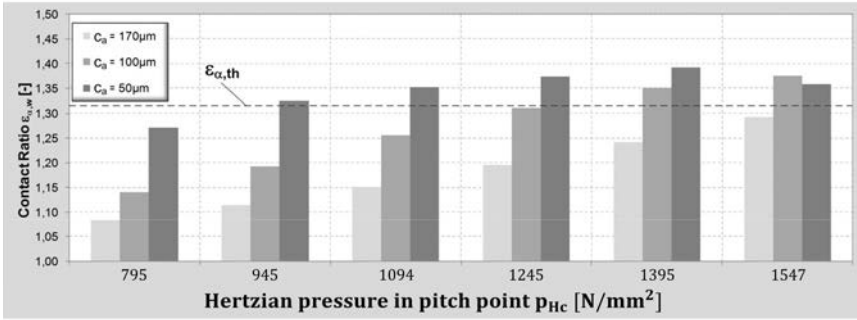

Figure 4 Contact ratio at different profile reliefs—including wear.

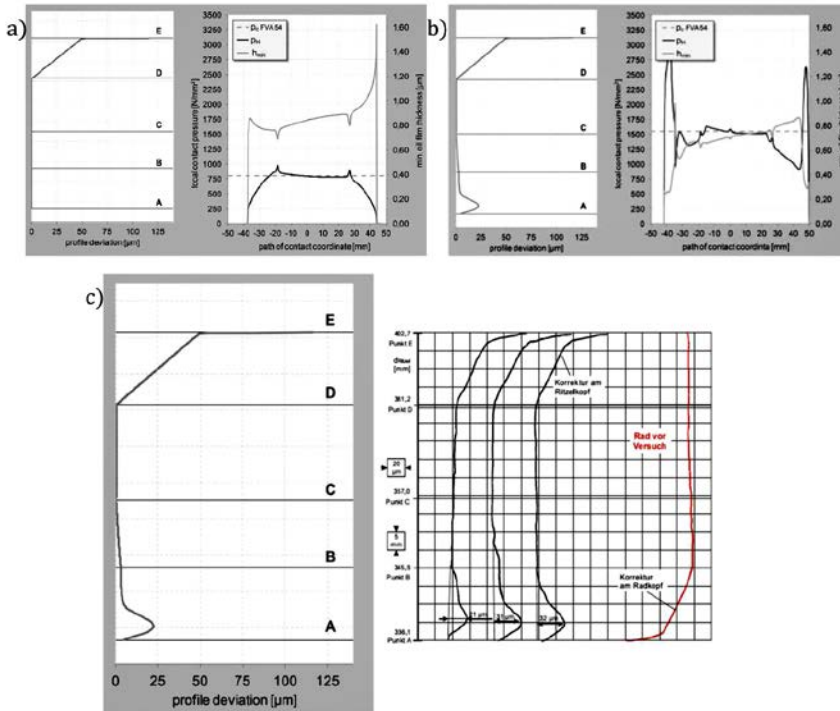

Figure 5 Contact pressure, min. oil film thickness, profile deviation for tip relief  $c_a = 50 \mu\text{m}$ : a) before LS5; b) after LS10; c) comparison to test results (Ref. 3).

$$\left(1 - \left(\frac{0,5\mu\text{m}}{\sum R_a}\right)^k \frac{v_g}{v_\Sigma}\right)^x \left(\frac{\sum R_a}{h_{\text{min}}}\right)^y \left(\frac{700\text{HV}}{\text{HV}_i}\right)^\delta \left[\frac{\mu\text{m}}{10^6}\right]$$

Herewith the factor  $k_S$  considers the chemical characteristics of the lubricant and the factor  $k_W$  includes the material properties of the gears. Solving the differential Equation 7 for a specific amount of load cycles  $dN$  leads to a certain amount of wear that is transferred onto the tooth profile. Carrying out a new meshing simulation with the newly worn out teeth leads to a changing path of contact in terms of the path of contact of unworn teeth and therewith to an altering load distribution throughout the wear simulation. Thus it is possible to simulate the micropitting test with reference to FVA 54 (Ref. 9). The factor  $k_S$  depends on oil type and chemical additive. For each type of lubricant this factor must be governed by an experimental test; it therefore may be used the FZG gear test rig, according to DIN 51354-1.

### Comparison to Test Results: Discussion

Subject of the investigation is the influence of the magnitude of tip reliefs on the profile deviation during the micropitting step test in terms of the FVA 54 (Ref. 9) test procedure at an average roughness of  $R_a = 0.5 \mu\text{m}$ .

Therefore, load steps five to ten are simulated and the computed profile deviation is compared to the profile deviation obtained with the test bench (Ref. 3); gear data used within the experimental tests and the simulation is listed in Table 1.

Taking load into consideration, the effective contact ratio can be computed by solving Equation 1 for a certain number of engagement positions. Figure 3 shows the true contact ratio  $\epsilon_{a,w}$  for the investigated tip reliefs for the load steps LS5 to LS10 without wear. A higher amount of tip relief results in a lower effective contact ratio within all six load steps.

Table 1 Gear set data			pinion	wheel
Normal module	$m_n$	[mm]	22	
Nuber of teeth	$z$	[-]	16	24
Profile shift factor	$x$	[-]	0,1817	0,1715
Helix angle	$\beta$	[°]	0	
Pressure angle	$\alpha_n$	[°]	20	
Operating pressure angle	$\alpha_{wt}$	[°]	22,4	
Center distance	$a$	[mm]	447,334	
Face width	$b$	[mm]	105	100
Profile contact ratio	$\epsilon_a$	[-]	1,31	
Average roughness	$R_a$	$\mu\text{m}$	0,5	0,5
Speed	$n$	[1/min]	450	300
Tip diameter	$d_a$	[mm]	402,69	570,62
Root diameter	$d_f$	[mm]	304,96	480,55
Oil viscosity	$\nu_{40}$	[mm <sup>2</sup> /s]	220	
Oil type		[-]	mineral oil with A99	

With increasing load, the effective contact ratio increases.

Within the simulation process, wear is computed for a specific amount of load cycles  $dN$  using Equation 7 and transferred onto the tooth profile. This leads to an altering circumferential backlash throughout time. In Figure 4 the effective contact ratio  $\varepsilon_{aw}$  is shown after  $2.1 \cdot 10^6$  load cycles for each load step.

For a tip relief of  $c_a = 50 \mu\text{m}$ , the effective contact ratio increases with the load step till load step LS9. Within load step LS10 the growth of wear due to contact pressure and sliding speeds in the area of first contact causes a decrease in the effective contact ratio. For a tip relief of  $c_a = 100 \mu\text{m}$  and  $c_a = 170 \mu\text{m}$  the effective contact ratio increases with load, but basically the effective contact ratio is less compared to the simulation without wear.

Figure 5 a) left shows the simulated profile deviation of the pinion before start of load step LS5 with a tip relief of  $c_a = 50 \mu\text{m}$ . On the right, the course of the contact pressure and oil film thickness vs. path-of-contact coordinate is depicted. In the area of first and last contact the contact pressure declines to zero. At the engagement points *B* and *D* the linear tip relief converges into the involute spline — which results into a small local radius of curvature and therefore an increase in the local pressure and a decrease in the local oil film thickness.

Figure 5 b) left shows the simulated profile deviation of the pinion after finishing LS10 with  $12.6 \cdot 10^6$  load cycles. In the area of first contact with the highest amount of sliding speeds, the oil film thickness collapses because of aggravating contact conditions due to the occurring wear. Within this area cratering wear occurs on the pinion. A comparison of the simulated wear with the test results in Figure 5 c) shows a very good correlation between the simulation and the experimental results.

Figure 6 a) left shows the simulated profile deviation of the pinion before start of load step LS5 with a tip relief of  $c_a = 100 \mu\text{m}$ . Comparing Figure 6 a) right to Figure 5 a) right, it can be stated that the effective contact ratio decreases with an increase in the amount of tip relief. The small radius of curvature at the engagement points *B* and *D*, where the linear tip relief converges into the involute spline, causes peaks within the course of the local contact pressure, and a collapse in the local oil film thickness.

Figure 6 b) left shows the simulated profile deviation of the pinion after finishing load step LS10. Due to the higher amount of tip relief

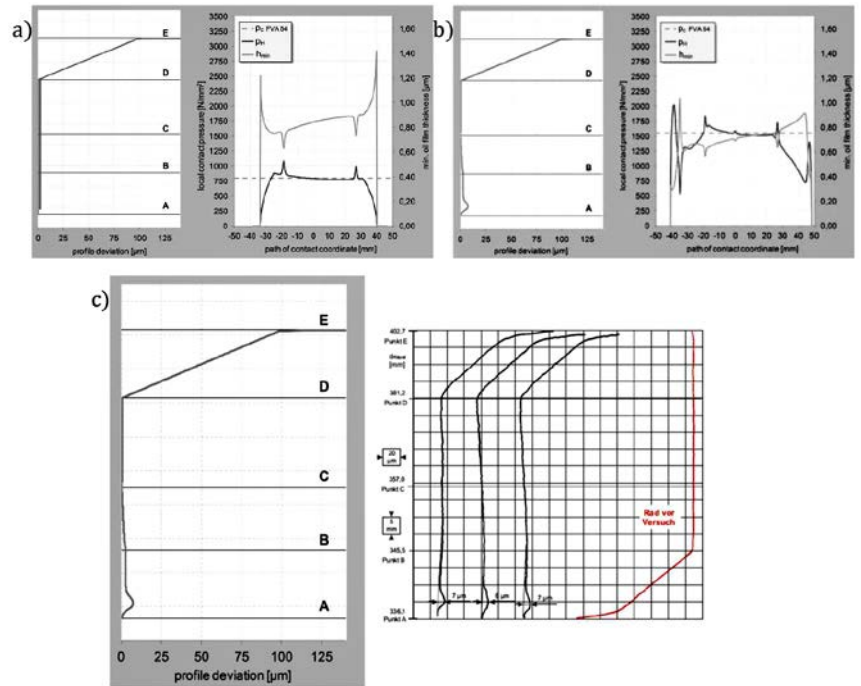

**Figure 6** Contact pressure, min. oil film thickness, profile deviation for tip relief  $c_a = 100 \mu\text{m}$ : a) before LS5; b) after LS10; c) comparison to test results (Ref. 3).

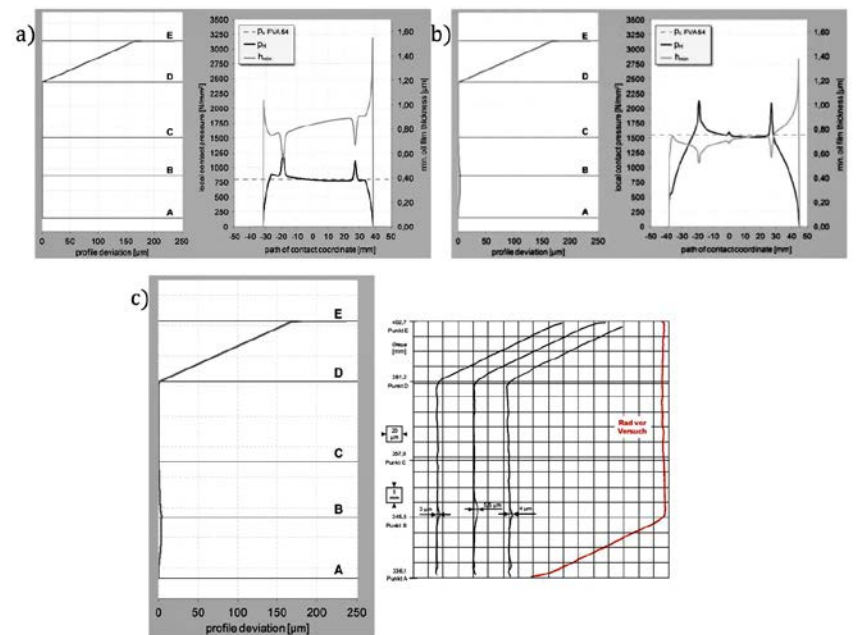

**Figure 7** Contact pressure, min. oil film thickness, profile deviation for tip relief  $c_a = 170 \mu\text{m}$ : a) before LS5; b) after LS10; c) comparison to test results (Ref. 3).

the magnitude of wear in the area of first contact is less compared to Figure 5 b) left, but cratering wear still occurs.

A comparison of the simulated wear with the test results in Figure 6 c) shows a very good correlation between the simulation and the experimental results.

Figure 7 a) left shows the simulated profile deviation of the pinion before start of LS5 with a tip relief of  $c_a = 170 \mu\text{m}$ .

Again, the small radius of curvature at the engagement points B and D causes peaks within the course of the local contact pressure and a collapse in the local oil film thickness.

Due to the applied tip relief of  $c_a = 170 \mu\text{m}$ , the point of first contact occurs subsequently and the effective contact ratio declines in comparison to variants with less tip relief. After finishing load step LS10, the maximum local contact pressure and the minimum oil film thickness occur at the engagement point

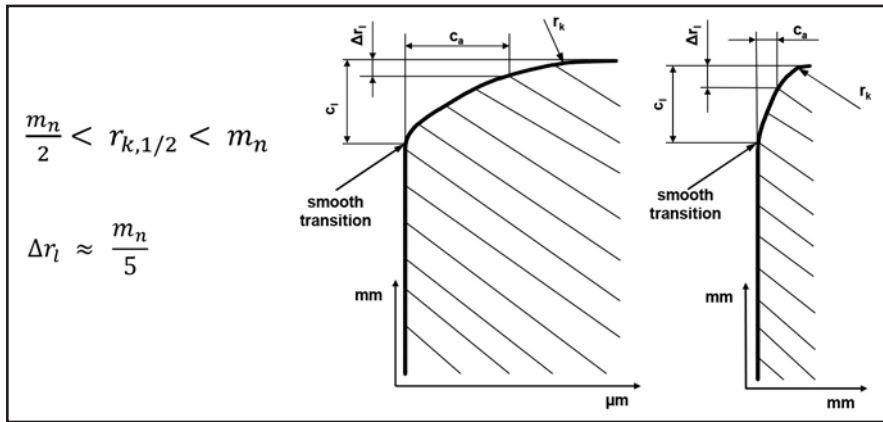

Figure 8 Optimal profile modification.

B. Therefore the location of maximum wear shifts from the point of first contact to the engagement point B.

A comparison of the simulated wear with the test results in Figure 7 c) shows a very good correlation between the simulation and the experimental results.

With an optimal profile modification pressure peaks could be avoided. An optimal profile modification consists of a smooth transition without sharp edges between involute profile and profile modifications and an additional tooth tip radius for smooth first contact. Figure 8 shows an optimal profile modification.

**Crack Criterion**

Micropitting or grey staining is a fatigue failure on tooth flanks, which is mainly influenced by local contact pressures, sliding speeds and lubrication conditions. It starts with micro-cracks on the surface of the flanks. Herewith, micropitting acts like a profile deviation on flanks in the area of negative specific sliding. Within this area, the tooth tip radius of the driven gear gets into contact with the dedendum of the driving gear.

Based on the fatigue phenomenon, the fatigue processes in the tooth flank contact can be described in detail. Two stages are distinguished here: Stage 1, the crack initiation, and Stage 2, the crack growth. Cracks occur where specific crack criteria are satisfied. Because of periodic stress in the tooth contact, the cracks can grow in their crack tips.

Cracks occur because of the stress superposition from the Hertzian contact stresses and near-surface shear stresses. The

near-surface shear stresses result from the sliding speed on the tooth flanks and the friction coefficient between the contact bodies. Boundary and hydrodynamic friction are separated here.

Containing the local flank pressures, the local rolling and sliding speeds, the local film thicknesses and further parameters from the meshing simulation, an empirical criterion for the initial cracking is presented for the contact of two tooth flanks. It is based on the Ruiz-Chen criterion (Ref. 4). It states that if two bodies are under dynamic load in contact, the product of the sliding path and shear stress is responsible for the first crack; this product can be regarded as friction energy. But the tangential tensile stress in the direction of the slip is also important for the crack beginning and for the crack characteristics. This is transferred to a gear and for the description of the tribological system the factor is upgraded with the relative lubricant film thickness. Equation 8 shows a first approach for such a crack criterion:

$$R = \frac{1}{750} \left( \frac{p_H}{[\text{MPa}]} \right)^\alpha \left( \frac{s_g}{[\text{mm}]} \right)^\beta e^{-(\gamma\lambda)} \left( 1 - \frac{v_g}{v_c} \right) \tag{8}$$

The crack criterion implies that in the case of two contacting tooth flanks under load, the product of an equivalent stress  $\sigma_{vG}^\alpha$ , sliding path  $S_g^\beta$  and the relative film thickness  $\lambda$  in the area of negative specific sliding, are responsible for the crack initiation. Thus an equivalent stress needs to be defined; for example, by means of the stresses of the Hertzian contact and the near-surface tangential stresses.

The equivalent stress must have a maximum in an angle, which is determined by experimental results of micropitting.

The sliding path between two contacting tooth flanks is given by Equation 9 from the product of the sliding speed  $v_g$  and the time  $\Delta t$ . The sliding path is limited by the Hertzian contact width  $2b_H$ . During the time  $\Delta t$  the flank area  $2b_H$  is in contact with the opposite flank by the rolling speed  $v_t$ .

$$s_g = \Delta t v_g = \frac{2b_H}{v_t^{1/2}} v_g \tag{9}$$

The relative lubricant film thickness  $\lambda$  is the ratio of the minimum lubricant film thickness and the surface roughness of the tooth flanks. Reference 3 shows that the reduction of the relative film thickness, increased by growing roughness, leads to micropitting. Therefore the Ruiz-Chen criterion is extended by this factor.

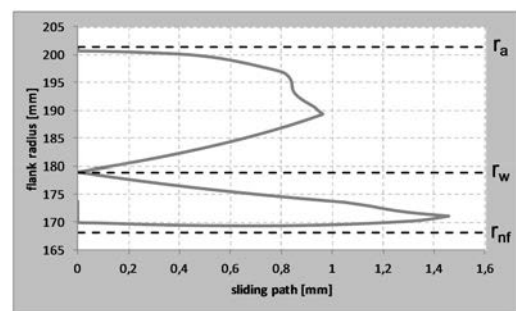
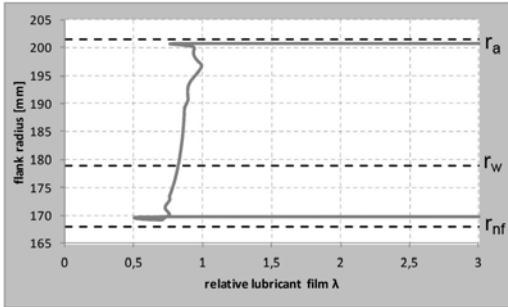

Figure 9 Sliding path over the flank area of the driven gear  $m_n = 22 \text{ mm}$ .

$$\lambda = \frac{h_{min}}{\frac{1}{n} \sum_{i=1}^n Ra_i}$$



**Figure 10** Relative oil film thickness versus the flank area of the driven gear  $m_n = 22$  mm

Micropitting preferentially occurs in the area of negative specific sliding, where the material is drifted due to the opposite direction of rolling and sliding speed. In this flank area the risk of cracks is significantly higher. This characteristic is included in Equation 8, with the factor  $(1 - \frac{v_g}{v_s})$ .

By means of such an empirical crack criterion, Equation 8, which is taking into account the stress conditions, the sliding speeds of the surface, and the lubrication condition, the critical surface areas regarding micropitting can be detected (Fig. 10). The exponents  $\alpha$ ,  $\beta$  and  $\gamma$  of Equation 8 must be determined with experimental results. Furthermore, a critical value  $R_{crit}$  must be defined, which indicates an increased risk of micropitting if the critical value is exceeded. The crack criterion is normalized to  $R_{crit} = 1$ . The criterion was validated by using the results of experimental results of Reference 3, (Fig. 10). The crack criterion agreed very well with the experimental results.

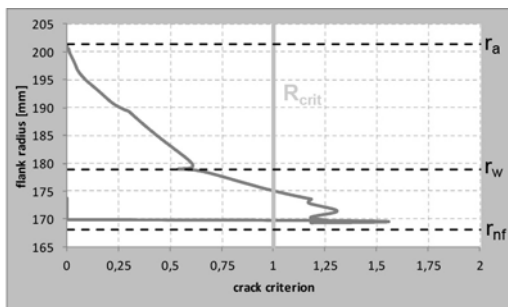

**Figure 11** Crack criterion indicating the flank region with higher risk of cracking.

## Summary

The presented algorithm combines a meshing simulation based on the tooth profile, taking corrections and wear into consideration, with a load algorithm including shaft and bearing deformation. It therefore follows that an accurate detection of the point of first and last contact is possible.

Based on the precise computation of the contact pressure, sliding speeds, and oil film thicknesses, a wear simulation for load and rotation spectra is presented. A comparison of the simulation with test results demonstrates a good accordance and confirms the approach. Therefore, an optimal profile modification with a quadratic or cubical tip relief and a tooth tip radius can calculate against micropitting or pitting. Furthermore, a crack criterion to determine the locations of micropitting is presented. 

## References

- ISO/TR 15144-1. Calculation of Micropitting Load Capacity of Cylindrical Spur and Helical Gears — Part 1: Introduction and Basic Principles, 2010.
- Linke, H. *Stirnradverzahnung – Berechnung Werkstoffe Fertigung*, Carl Hanser Verlag Munchen Wien, 1996 Gottingen.
- Lutzig, G. *Gro.getriebe-Graufleckigkeit: Einfluss von Flankenmodifikationen und Oberflächenrauheit*, Dissertation, Ruhr-Universität Bochum, Bochum, 2006.
- Ruiz, C. and K.C. Chen. “Life Assessment of Dovetail Joints Between Blades and Discs in Aero Engines,” *Fatigue of Engineering and Structures*, Institute of Mechanical Engineers, London, 1986, 187-194.
- Kunert, J. “Experimentell Gestützte Untersuchung zum Verformungs- und Spannungsverhalten an au.Enverzahnnten Stirnrädern für eine Verbesserte Beanspruchungsanalyse,” Dissertation, Technische Universität Dresden, August 1998.
- Wisniewski, M. “Elastohydrodynamische Schmierung, Grundlagen und Anwendungen, Handbuch der Tribologie und Schmieringstechnik,” Band 9, Expert-Verlag, Renningen-Malmsheim, 2000.
- Suh, N. P. “The Delamination Theory of Wear,” *Wear* 25, 1973.
- Kragelskij, I.V., N. Dobyčín and V. “Kombalov. Sergeevič: Grundlagen der Berechnung von Reibung und Verschleiß,” Munchen, Wien: Hanser, 1983.
- FVA - Informationsblatt Nr. 54/I – IV. “Testverfahren zur Untersuchung des Schmierstoffeinflusses auf die Entstehung von Grauflecken bei Zahnradern,” Frankfurt, 1993
- Walkowiak, M. “Örtliche Belastungen und Verschleißssituation in den Zahnengriffen Profilkorrigierter,” Gerad- und Schragverzahnter Stirnradgetriebe Zwischen Einfederungsbeginn und Ausfederungsende, Dissertation, Ruhr-Universität Bochum, Bochum 2013.

**Christoph Lohmann** studied mechanical engineering at the University of Applied Sciences of the Lower Rhine in Krefeld and at the Ruhr University Bochum, graduating as a cooperative engineer-in-training at Bayer AG. He concluded his studies in 2012 with his master's thesis — “Simulation of System Dynamics of Heavy Drivetrains with Multi-Body Simulation” — at SEW-Eurodrive GmbH & Co KG in Bruchsal. In 2012 he started as a research assistant at the Chair of Industrial and Automotive Drivetrains of Prof. P. Tenberge. Lohmann's fields of research are tooth contact analysis, tooth profile modifications, fatigue failure and tribological stresses.



**Prof. Dr.-Ing. Peter Johannes Tenberge** since 2012 is Chair of industrial and automotive drivetrains at Ruhr-University Bochum. He has previously served (1994-2012) as professor for machine elements at Chemnitz University; (1992-1994) general manager for development and sales of INA Motorenelemente Schaeffler KG; (1989-1992) head of R&D of INA Wälzlager Schaeffler KG; and (1986-1989) as a project engineer at Zahnradfabrik Friedrichshafen AG. Tenberge has, in his career thus far, proposed for automotive applications several transmission concepts for AT, DCT, CVT and Hybrids, and in 2012 was awarded the SAE/Timken Howard Simpson Automotive Transmission and Driveline Innovation Award. He also keeps busy working on various industrial applications in which he works on design, development and simulation tools for a more precise and quicker layout of transfer gears, worms gear, bevel gears and planetary gears. Tenberge is also the holder or co-holder of more than 200 national and international patent applications.



**Dr.-Ing. Matthias Walkowiak** has since 2013 worked as a calculation and development engineer at SEW-Eurodrive GmbH & Co KG in Bruchsal. Upon receipt of his engineering degree he began his career at the chair of Machine Elements, Gears and Motor Vehicles of Prof. W. Predki at the Ruhr University Bochum as a research assistant. He completed his PhD successfully in 2013 with the doctoral thesis, “Local Loads and Wear Simulation of Tooth Meshing on Spur and Helical Gears with Profile Modifications Between the Beginning and the Ending of the Deflection,” at the chair of Industrial and Automotive Drivetrains of Prof. P. Tenberge.



# An Approach to Pairing Bevel Gears from Conventional Cutting Machine with Gears Produced on 5-Axis Milling Machine

Inho Bae and Virgilio Schirru

Developed here is a new method to automatically find the optimal topological modification from the predetermined measurement grid points for bevel gears. Employing this method enables the duplication of any flank form of a bevel gear given by the measurement points and the creation of a 3-D model for CAM machining in a very short time. This method not only allows the user to model existing flank forms into 3-D models, but also can be applied for various other purposes, such as compensating for hardening distortions and manufacturing deviations which are very important issues but not yet solved in the practical milling process.

## Introduction

Recently, cutting bevel gears on universal 5-axis milling machines has been widely accepted as a promising solution to replace the conventional cutting process. The process is highly flexible and does not require special tools. Thus, it is particularly suitable for small batches, prototypes, and repairs in use having unacceptably high lead times. In order to apply the milling process for bevel gear cutting, we should provide feasible solid models. However, the kinematic geometry of bevel gears is relatively complicated in accordance with the variety of the cutting method, such as Gleason (fixed settings, Duplex and Zerol), Klingelnberg (Cyclo-Paloid and Palloid) and Oerlikon, and it's not easy to generate the 3-D geometry model proper for milling.

In the calculation software *KISSsoft* (Ref. 1), the geometry calculation of straight and skew bevel gears for standard cone types has been available for many years, in accordance with ISO 23509 (Ref. 2). Then, the expansion to 3-D models of spiral bevel gears was made covering all cone types four years ago. Since the 3-D models of the spiral bevel gears have been available, there has been much interest from many companies worldwide. The first prototype based on the 3-D model was machined by Breton (Ref. 7), one of the major 5-axis milling machine manufacturers, and enjoyed very satisfactory results. Then one of

their customers, who is using a 5-axis milling machine, wanted to produce a very large bevel gear pair to replace an existing pair. However, they had a special, hard to resolve problem in that the pinion shaft having a 1,500 mm length was too long to be cut on the Breton machine. So the pinion was produced on a conventional Gleason machine, but the customer wanted to produce the gear ( $d_{e2} = 500$  mm) on the Breton machine. We always recommend to our users that the model for the pinion and gear must be generated by the same software and thus the combination of a pinion, manufactured on a Gleason machine, should not be combined with a gear based on the model. But the customer insisted, so we had to invent something!

We got the basic gear data and the measurement grid points of the flank form of the gear produced by their Gleason software from the customer.

However, the design data didn't include the formal definition of the flank modifications. Thus, the comparison of these measurement points with the 3-D model naturally showed small deviations. The deviation could not be eliminated easily by varying the geometric parameters and applying typical modifications such as barreling (profile crowning) and lead crowning. Thus, we developed a creative solution to generate a 3-D model of the gear and to adapt it to the given grid point from Gleason. In the following chapters we will show the procedure of the method and the application results.

## Topological Modification of the Bevel Gear

The basic cone geometry of the bevel gear can be defined in accordance with ISO 23509, and the flank form is defined from the transverse tooth forms calculated along the face width. The trace form

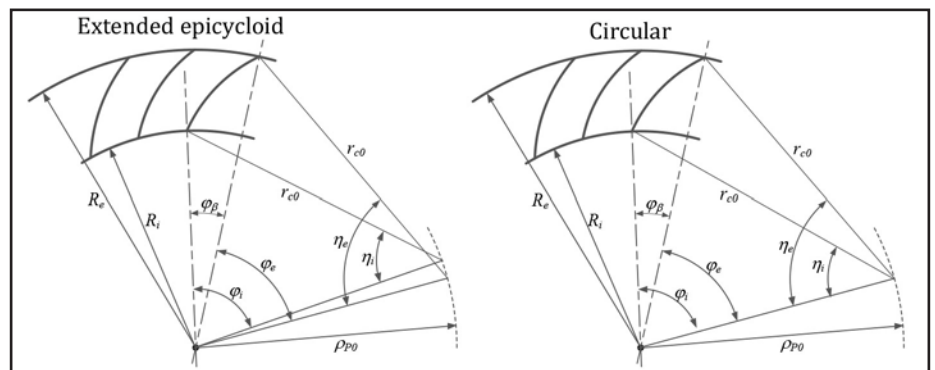

Figure 1 Face hobbing (left) and face milling (right) processes.

This paper was originally presented at the 2014 International Gear Conference, Lyon Villeurbanne, France and is republished here with the authors' permission.

will be the extended epicycloid form by face hobbing process or circular form by face milling (Fig. 1). In *KISSsoft*, the tooth form is supposed to be the planar involutes of the virtual spur gear in transverse section. Then, the tooth flank surface is generated by splining the tooth forms of each section.

Bevel gear machine tool manufacturers (such as Klingelnberg and Gleason) have their own methods to generate the tooth form based on the generating motion of the cutter. The tooth form is known as an octoid and is slightly different from spherical or planar involute tooth form. However, the difference of the tooth forms is normally less than the tolerance range and will pose no problem in practical use. This can be verified from the fact that the bevel gears are always produced in pairs by the same process in order to achieve a good contact pattern in practice. In order to validate the practical usage of the 3-D model we compared our model with reference models of manufacturer programs and also carried out the contact pattern check with the actual model. The results showed the tooth flanks along the face width of the two models are very well matched with only slight differences (Ref.3).

One of the most important tasks is to find the optimal modification to give good contact pattern in a bevel gear pair. The contact pattern of the bevel gear pair can be easily optimized by using proper modifications (Fig. 2). There are eight types of modifications available for bevel gears in *KISSsoft* (profile; crowning; eccentric profile crowning; pressure angle modification; helix angle modification; lead crowning; eccentric lead crowning; twist; and topological modification). The user can define different combinations of modification for drive and coast flanks to optimize the contact pattern separately.

However, if the target modification has highly non-linear or irregular pattern, the simple combination of the conventional modifications cannot be applied. In that case, the topological modification should be used to allow the user to freely define any type of modification that can't be covered by the conventional modifications. The user can define the modifications in a data map of factors at any position along the face width and along the tooth height by using the topological

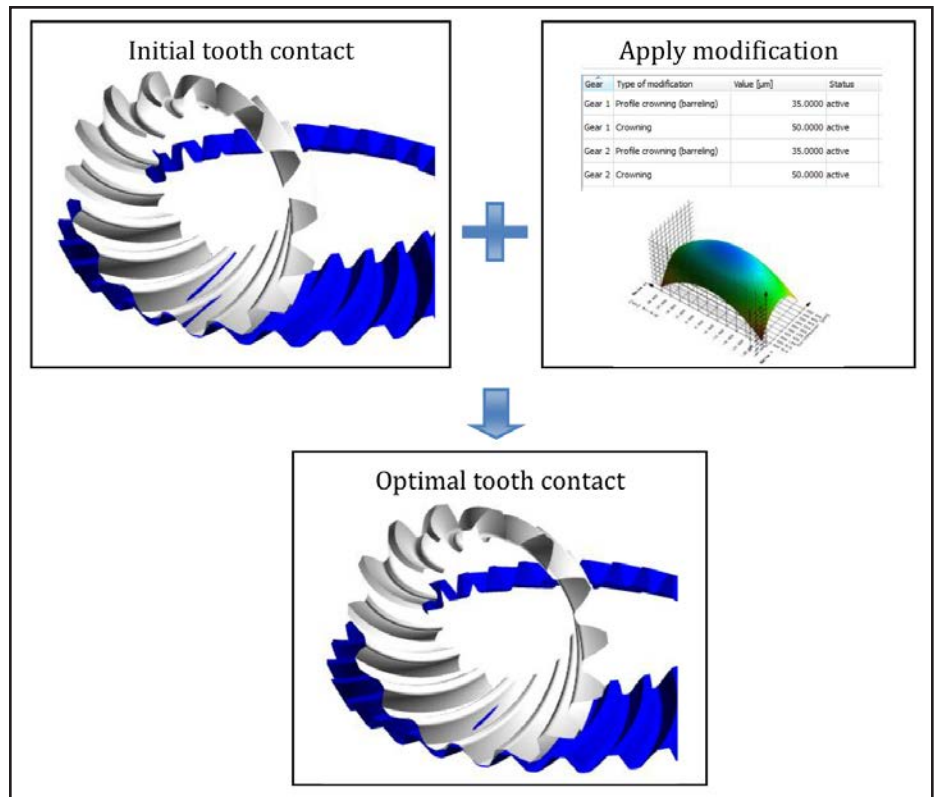

Figure 2 Optimal contact pattern with flank modifications.

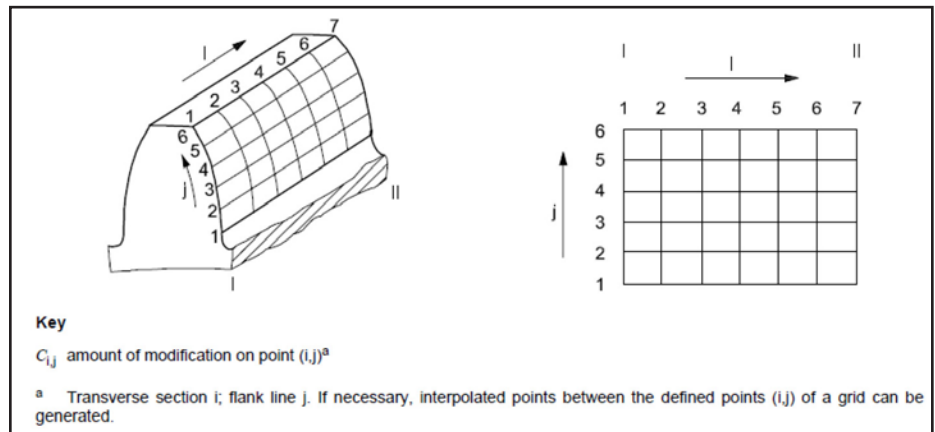

Figure 3 Definition of topological modification in ISO 21771 (Ref. 5).

modification following the convention in ISO 21771 (Ref.4) as shown in Figure 3.

Figure 4 shows an example of the file structure of the modification used in KISSsoft. The example data map defines the progressive tip relief on Side I and no modification on Side II. Note that the modification values in the data map are normalized and the actual local modifications are calculated with  $Ca_{local} = fij * Ca$ , where  $fij$  is the modification factor at  $(i, j)$  node and  $Ca$  is the amount of modification. The intermediate values in between the data can be interpolated by linear, quadratic, or spline

approximation along the tooth width and height, respectively.

The adjustment of the bevel gear models to any predetermined measurement grid points should now be possible by applying the topological modification. That is, the modification can be calculated as the deviation between the surface of the 3-D model and the measurement grid points of the target model. The measurement grid points report contains the Cartesian coordinates and the normal vectors of the grid points with the format of  $(XP YP ZP XN YN ZN)$ . The reference coordinate system of the data is different according to the measurement

machines. For example, the reference coordinate system of Klingelnberg format is using the convention shown in Figure 5. The order of the indexes for the points and the sections are defined according to ISO/TR 10064-6 (Ref.5) as well as the convention from the manufacturers such as Klingelnberg (Ref.6). Here the index of the lines starts from the root to the tip, and the index of the columns from Side II (heel) to Side I (toe).

In applying the modification, however, various problems have arisen. The definition of topological modification surface in helical gears is located between the tip and the root form diameters, but the diameters over the tooth width for bevel gears are changing.

On the other hand, the effort to transform the measured grid points to the format of the topological modifications is greatly increased. While the measurement direction of the distance between the two corresponding grid points for adjustment calculation is different from the normal of the tooth form (that is, the path of contact) along which the modification is applied. Moreover, even the deviation values are given correctly, we cannot easily reach to the exact surface points because the target modification can have highly nonlinear pattern.

Thus, the procedure to get the topological modification, so that the final model becomes equivalent with the target model, cannot be finished in just a single step but requires rather several iterations (Fig.6). In each step, the distance between the corresponding measurement points are calculated and converted into the dimension in the virtual cylindrical gear. Then the topological modification is calculated based on these values and applied to generate a new measurement grid. The procedure iterates until the given acceptance criteria are met. The acceptance criteria are given as the maximum distance between the surface of the 3-D model and the corresponding measurement points is smaller than the user-defined tolerance.

**Application and Result**

We used 11x7 points for the measurement and topology template definition; that is, 11 points starting from Side I (toe) to Side II (heel), and 7 points from the root form diameter to the tip diam-

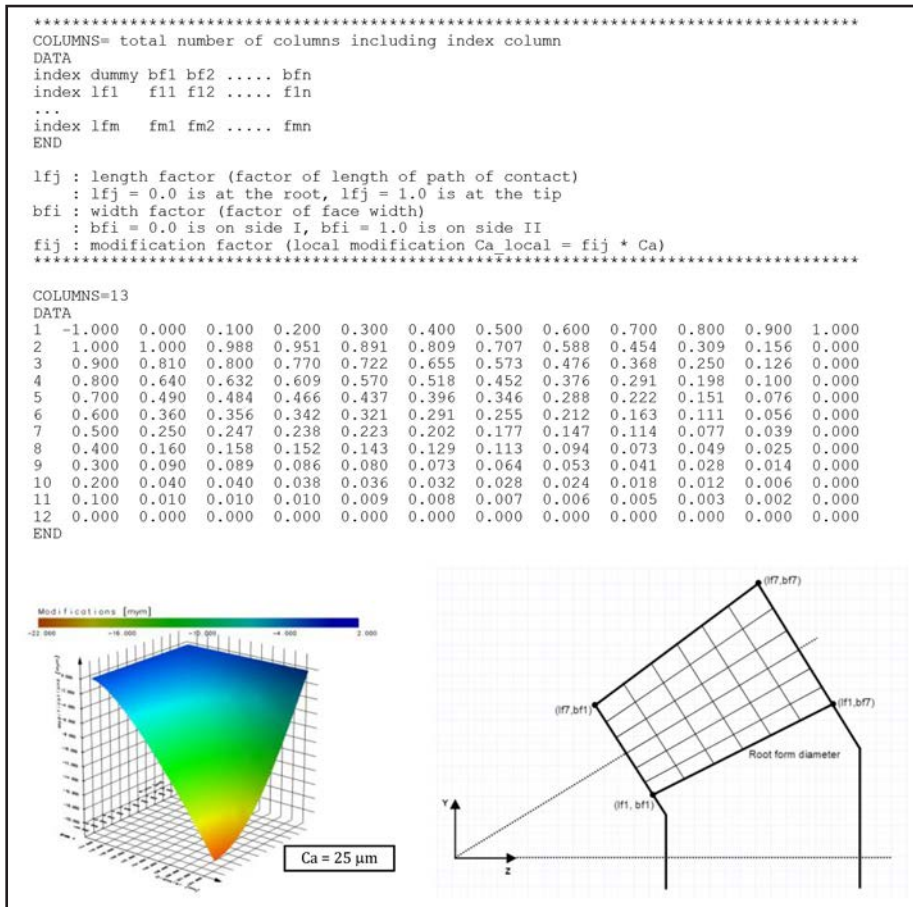

Figure 4 Definition of topological modification and example.

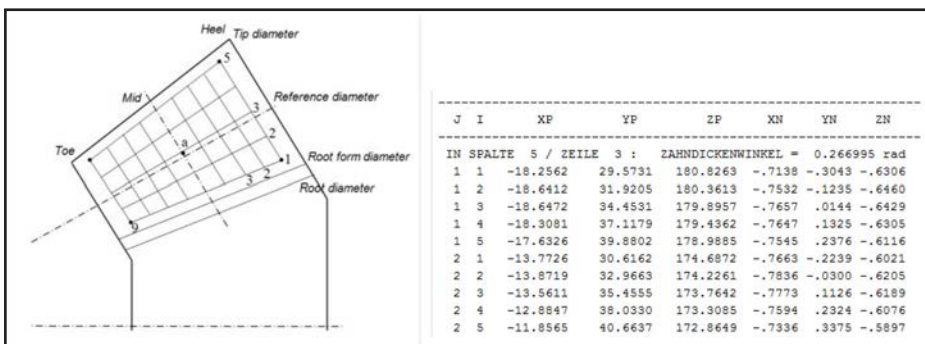

Figure 5 Measurement grid convention of Klingelnberg machine format.



eter without margins. The position of each measurement point is defined as the length factor of the path of contact from the root form diameter to the tip diameter (column values in yellow in Table 1) and the face width factor from Side I to Side II (row values in yellow in Table 1).

**Topological modification for the right flank.** Table 1 shows the topological deviation and modification template values for the right flank according to the calculation steps. In the calculation, we set the acceptable maximum deviation to 5  $\mu\text{m}$ .

**Step 1.** In the first step we measure the deviation by the normal distance between the measurement points of the Gleason model with the flank surface of 3-D model (see Deviation 1 in Table 1). Then, we use the Deviation 1 as the initial topological template, Modification 1. The green-colored fields in the table indicate the border of the tooth flank. In our modeling strategy we use a slightly bigger surface area to cover the real gear surface and it's not possible to measure correct distances at the borders. Thus we ignore the border values in the acceptance checking in the calculation procedure and use the extrapolated values for the values. The maximum distance of the initial step gives 575  $\mu\text{m}$  at the position (0.965, 0.696). The deviation shows relatively big values because we intentionally increased the tooth thickness of the *KISSsoft* model to completely cover the surface of the target model and to give positive distances. Thus, the final model is compensating not only the topological deviation of the surface but also the tooth thickness deviation of the model.

**Step 2.** After applying the topological modification of the first step, the maximum distance at the position (0.965, 0.696) reduced to 65  $\mu\text{m}$  and the new maximum distance is 135  $\mu\text{m}$  at the position (0, 0.879) (see Deviation 2 in Table 1). From Deviation 2 you will see the three points at (0, 0.089), (0.522, 0.089) and (0.965, 0.193) have deviations less than the acceptance criteria of 5  $\mu\text{m}$  (values in blue). In this case we use the same topological modification values of the last step at those positions. For the remaining positions we build a new topological modification by linear summation of the deviation of each point and the last topological modification, which is:

$$\text{Modification 2} = \text{Modification 1} + \text{Deviation 2}$$

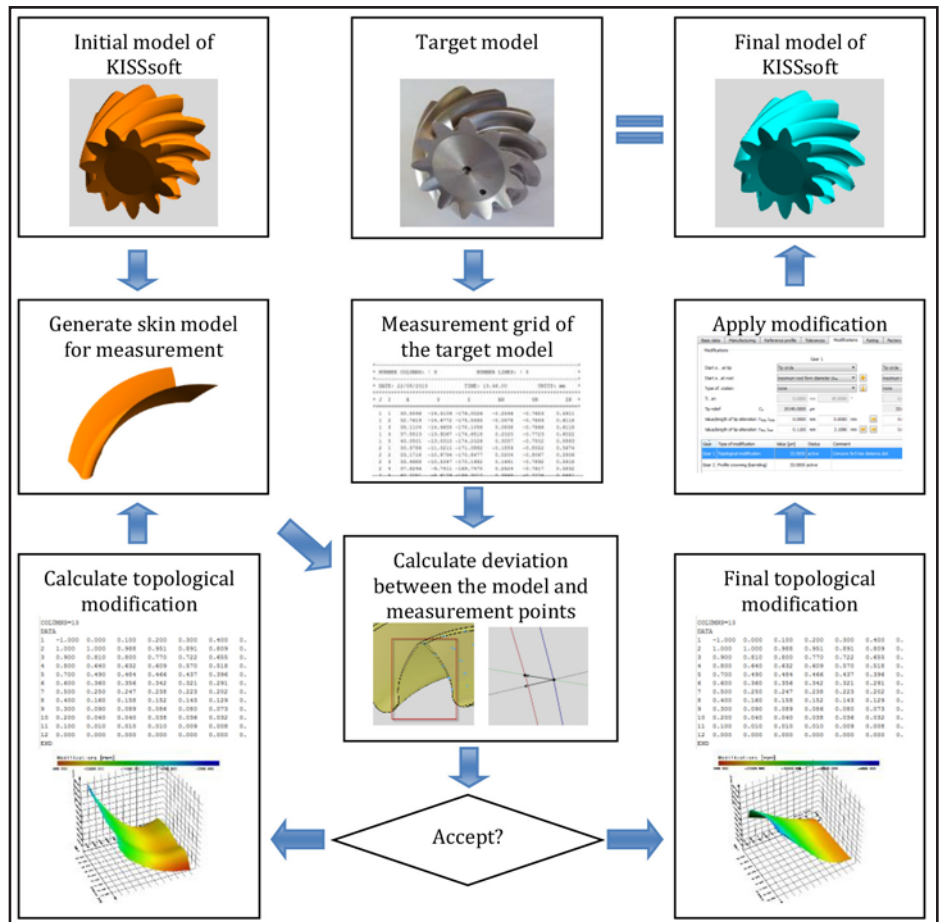

Figure 6 Procedure to get topological modification for target model.

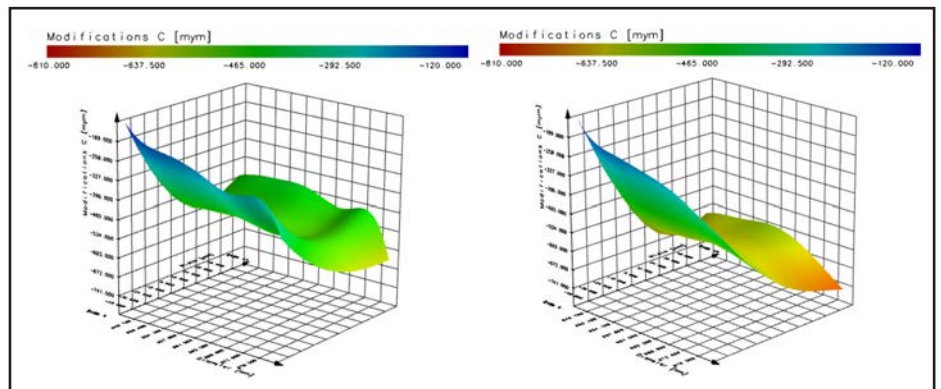

Figure 7 Modifications for right flank at Step 1 (left) and Step 11 (right).

**Table 1 Topological deviations and modifications according to iteration steps (right flank, values in  $\mu\text{m}$ )**

Deviation 1	1	-1	0	0.089	0.193	0.297	0.399	0.5	0.599	0.696	0.789	0.879	1
<b>Modification 1</b>	2	1	395	446	496	536	567	591	608	619	626	629	631
	3	0.965	342	397	451	495	528	552	568	575	574	566	558
	4	0.744	289	348	407	453	489	514	527	530	523	504	484
	5	0.522	245	311	376	428	468	495	510	511	500	473	446
	6	0.301	207	280	353	412	458	490	508	510	498	467	436
	7	0.08	168	251	333	401	455	493	515	521	510	479	447
	8	0	129	222	314	390	451	495	523	532	522	490	459
<b>Deviation 2</b>	1	-1	0	0.089	0.193	0.297	0.399	0.5	0.599	0.696	0.789	0.879	1
	2	1	22	-7	-36	-18	-2	10	20	26	27	21	15
	3	0.965	19	12	4	19	33	46	56	65	71	72	73
	4	0.744	16	30	44	57	69	82	93	104	115	123	131
	5	0.522	-15	4	22	39	55	70	81	92	102	106	111
	6	0.301	-4	14	32	49	66	82	93	105	115	121	127
	7	0.08	-14	8	30	49	67	84	98	111	122	128	134
	8	0	-24	3	29	49	69	87	103	116	129	135	141
<b>Modification 2</b>	1	-1	0	0.089	0.193	0.297	0.399	0.5	0.599	0.696	0.789	0.879	1
	2	1	382	414	451	515	561	598	625	641	646	640	631
	3	0.965	373	409	451	514	561	598	624	640	645	638	629
	4	0.744	316	378	451	510	558	596	620	634	638	627	612
	5	0.522	237	311	398	467	523	565	591	603	602	579	548
	6	0.301	216	294	385	461	524	572	601	615	613	588	554
	7	0.08	170	259	363	450	522	577	613	632	632	607	573
	8	0	118	222	343	439	520	582	626	648	651	625	590
<b>Deviation 3</b>	1	-1	0	0.089	0.193	0.297	0.399	0.5	0.599	0.696	0.789	0.879	1
	2	1	-45	14	72	74	75	77	81	88	104	122	141
	3	0.965	-11	14	39	38	39	41	45	51	60	70	81
	4	0.744	22	14	6	1	2	6	10	13	16	18	20
	5	0.522	0	0	0	5	8	12	17	20	23	27	30
	6	0.301	4	5	6	11	12	15	19	23	27	30	34
	7	0.08	6	4	2	6	9	14	18	21	26	30	33
	8	0	7	2	-3	2	6	12	17	20	26	29	32
<b>Modification 3</b>	1	-1	0	0.089	0.193	0.297	0.399	0.5	0.599	0.696	0.789	0.879	1
	2	1	383	395	410	471	516	645	675	698	713	718	725
	3	0.965	377	395	416	476	522	639	669	691	705	708	712
	4	0.744	336	392	457	510	558	602	630	647	654	645	633
	5	0.522	237	311	398	467	531	577	608	623	625	606	580
	6	0.301	211	294	391	472	536	587	620	638	640	618	588
	7	0.08	170	259	363	456	531	591	631	653	658	637	609
	8	0	118	222	343	439	526	594	643	668	677	654	623
<b>Modification 11 (Final step)</b>	1	-1	0	0.089	0.193	0.297	0.399	0.5	0.599	0.696	0.789	0.879	1
	2	1	376	432	498	555	602	645	675	698	713	726	744
	3	0.965	364	422	490	548	595	639	669	691	705	715	728
	4	0.744	288	357	438	505	552	602	630	647	654	645	633
	5	0.522	246	319	404	476	537	577	608	629	633	615	591
	6	0.301	218	298	391	472	536	587	620	638	640	625	605
	7	0.08	170	259	363	456	531	591	631	653	664	644	617
	8	0	123	225	343	439	526	594	643	667	683	660	629
<b>Deviation 12 (Final step)</b>	1	-1	0	0.089	0.193	0.297	0.399	0.5	0.599	0.696	0.789	0.879	1
	2	1	19	10	1	-2	3	-5	0	2	6	-2	-11
	3	0.965	8	5	2	0	2	0	2	3	4	0	-3
	4	0.744	-2	1	4	2	2	5	4	4	2	3	4
	5	0.522	4	3	2	2	3	4	4	2	2	4	5
	6	0.301	3	3	2	2	1	1	2	2	3	0	-3
	7	0.08	5	3	0	1	1	0	3	4	2	1	1
	8	0	8	3	-2	1	1	0	3	5	0	2	4

**Step 3.** Now Deviation 3 after applying Modification 2 shows smaller distances than Deviation 2, and more positions fitting into the acceptance deviation. The new maximum distance is  $70\mu\text{m}$  at the position (0.965, 0.879) (see Deviation 2 in Table 1). However, the deviation in several positions—such as the positions at (0.956, 0.089) and (0.956, 0.193)—increased because the surface is generated by spline approximation from the topological modification template (values in red). In this case we build a new topological modification from the last topological modification, that is:

$$\text{Modification3} = \text{Modification2} - \text{SIGN}(\text{Modification2} - \text{Modification1}) * (\text{Deviation2}) + (\text{SIGN}(\text{Deviation2}) + \text{SIGN}(\text{Deviation3})) / 2 * (\text{Deviation2} - \text{Deviation3}).$$

**Step 11 (final step).** We then needed to iterate 11 steps until all deviations fit into the acceptance criteria. You can find the final topological modification as Modification 11, and the final deviation as Deviation 12, in Table 1. Now all the deviation values are less than the maximum deviation of  $5\mu\text{m}$ —except the values at the border.

The graphical comparison of the modification surfaces of Step 1 and the Step 11 (final step) are shown in Figure 1. As you can expect, the final modification surface doesn't show a regular pattern, and it's impossible to achieve the modification by simple combination of the conventional modification types such as crowning and barrelling.

**Topological Modification for the Left Flank**

After finishing the calculation for the right flank, we applied the same procedure for the left flank. Table 2 shows the topological deviation and modification template values according to the calculation steps for the left flank.

**Step 1.** In the first step the maximum distance of the left flank shows  $570\mu\text{m}$  at the position (0.965, 0.789).

**Step 14 (final step).** We could reach the final topological modification after 14 steps for the left flank. You can find the final modification as Modification 14 and the final deviation as Deviation 15. You can see all the deviation values

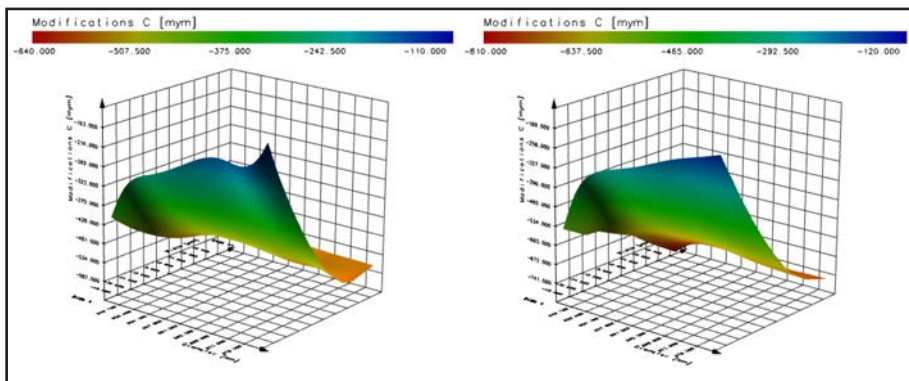

Figure 8 Modifications for left flank at Step 1 (left) and Step 14 (right).

are less than the maximum deviation of 5 μm, except the values at the border. The graphical comparison of the modification surfaces of Step 1 and the Step 14 (final step) are shown in Figure 8.

## Conclusions

The developed method makes it possible to incorporate any desired flank form of a bevel gear given by grid points, and provides the model for the CAM machining in a very short time from the simplest way. That is, the macrogeometry is generally assumed by existing standards or data sheets, and the microgeometry is created by a difference of unmodified real flank-to-the-flank created by topological modifications with the help of *KISSsoft*. The results showed that the final flank with the topological modification gives the deviation of less than 5 μm, which can be ignored, considering the manufacturing tolerance in practical situations.

The method presented here has considerably high potential for practical usage because it allows not only the modeling of all existing flank forms into 3-D models, but also can be applied for various other purposes, such as to compensate hardening distortions and cutting deviations of 5-axis milling models. These are very important features in practice, and were unresolved issues in the 5-axis milling process. ⚙️

## References

1. KISSsoft AG. Calculation Program for Machine Design. <http://www.kisssoft.ch>.
2. ISO 23509 (2006). Bevel and Hypoid Gear Geometry. <http://www.iso.org>.
3. Bae, I. and J. Langhart. "Können 5-Achsgefräste 3D-Kegelräder mit Konventionell Hergestellten Kegelrädern Gepaart Werden?" 2013, *Dresdner Maschinenelemente Kolloquium* 2013, 135-152
4. ISO 21771 (2007). Gears: Cylindrical Involute Gears and Gear Pairs — Concepts and Geometry.
5. ISO/TR 10064-6 (2009). Code of Inspection Practice — Part 6: Bevel Gear Measurement Methods.
6. Klingelnberg, J. *Kegelräder*, 2008, Springer.
7. Breton S.p.A., <http://www.breton.it>

**Table 2 Topological deviations and modifications according to iteration steps (left flank, values in μm)**

Deviation 1	1	-1	0	0.089	0.193	0.297	0.399	0.5	0.599	0.696	0.789	0.879	1
Modification 1	2	1	110	199	287	365	434	493	538	568	578	569	559
	3	0.965	145	225	306	375	438	490	531	558	570	564	558
	4	0.744	181	252	324	386	441	488	524	549	561	559	556
	5	0.522	219	281	344	397	444	484	515	537	548	549	549
	6	0.301	269	320	372	416	454	487	513	531	541	543	545
	7	0.08	342	382	423	456	486	511	531	544	552	555	559
	8	0	415	444	473	497	518	535	548	557	563	568	572
Deviation 2	1	-1	0	0.089	0.193	0.297	0.399	0.5	0.599	0.696	0.789	0.879	1
	2	1	63	62	60	63	67	70	77	87	105	120	135
	3	0.965	34	38	43	53	63	73	84	96	112	125	138
	4	0.744	4	15	27	44	59	77	92	106	119	130	141
	5	0.522	33	38	43	53	63	75	87	100	114	127	140
	6	0.301	35	40	46	57	68	80	91	105	118	132	145
	7	0.08	65	66	66	73	81	90	100	113	126	140	154
	8	0	95	91	87	90	94	100	109	121	135	149	163
Modification 2	1	-1	0	0.089	0.193	0.297	0.399	0.5	0.599	0.696	0.789	0.879	1
	2	1	188	262	349	428	501	563	615	654	682	689	698
	3	0.965	189	263	349	428	501	563	615	654	682	689	698
	4	0.744	195	267	351	430	500	565	616	655	680	689	701
	5	0.522	261	319	387	450	507	559	602	637	662	676	695
	6	0.301	310	360	418	473	522	567	604	636	659	675	697
	7	0.08	413	448	489	529	567	601	631	657	678	695	718
	8	0	514	535	560	587	612	635	657	678	698	717	743
Deviation 3	1	-1	0	0.089	0.193	0.297	0.399	0.5	0.599	0.696	0.789	0.879	1
	2	1	49	33	16	-2	1	16	30	36	36	34	32
	3	0.965	27	20	12	3	5	14	22	27	30	31	33
	4	0.744	6	7	7	7	9	11	14	18	23	28	33
	5	0.522	6	6	6	7	9	11	15	19	24	28	33
	6	0.301	1	3	5	8	11	15	18	22	26	30	35
	7	0.08	18	17	16	15	16	18	21	25	29	34	39
	8	0	35	31	27	23	21	21	23	27	33	39	44
Modification 3	1	-1	0	0.089	0.193	0.297	0.399	0.5	0.599	0.696	0.789	0.879	1
	2	1	218	284	361	427	500	577	638	682	713	720	730
	3	0.965	216	283	361	428	501	577	637	681	712	720	731
	4	0.744	202	274	358	437	509	576	630	673	703	717	736
	5	0.522	267	325	393	457	516	570	617	656	686	704	728
	6	0.301	310	360	418	481	533	582	622	658	685	705	732
	7	0.08	431	465	505	544	583	619	652	682	707	729	759
	8	0	548	566	587	610	633	656	680	705	731	756	790
Modification 14 (Final step)	1	-1	0	0.089	0.193	0.297	0.399	0.5	0.599	0.696	0.789	0.879	1
	2	1	158	241	337	427	506	577	638	682	713	728	747
	3	0.965	166	246	340	428	506	577	637	681	712	727	747
	4	0.744	211	279	358	437	509	576	630	673	703	723	750
	5	0.522	267	325	393	457	516	570	617	656	686	710	742
	6	0.301	310	360	418	481	533	582	622	658	690	712	742
	7	0.08	436	474	518	546	583	619	652	682	714	738	770
	8	0	554	579	608	610	633	655	675	709	740	767	803
Deviation 15 (Final step)	1	-1	0	0.089	0.193	0.297	0.399	0.5	0.599	0.696	0.789	0.879	1
	2	1	2	1	0	0	-1	2	5	6	5	0	-4
	3	0.965	0	1	2	1	1	2	3	4	4	1	-3
	4	0.744	-1	1	4	2	3	2	2	2	3	1	-2
	5	0.522	6	4	1	0	2	3	4	5	5	1	-4
	6	0.301	2	3	4	2	2	3	3	4	2	2	1
	7	0.08	6	3	1	3	4	3	4	5	2	3	3
	8	0	11	4	-3	5	5	3	5	5	2	4	5



**Inho Bae, Ph.D.**, received his doctorate in 2002 from Hanyang University in Korea by the research on the design of multi-stage gearboxes. After working as a post-doctoral research fellow at Kyoto University, he moved in 2008 to KISSsoft AG in Switzerland as a development engineer. Dr. Bae is the head of technical support and also working on the development of the KISSsoft and KISSsys software suites.



**Virgilio Schirru** was trained as a mechanical engineer at the University of Cagliari in Italy and at the Glasgow University of Scotland. After working for M.g. Mini Gears S.p.a. in their sintering and cut steel department for cylindrical and bevel gears, Schirru joined KISSsoft AG as a support/development engineer.



# Index

## INVESTS IN LEITZ CMM

Index Corporation recently took delivery of a Leitz CMM (coordinate measuring machine) Model PMM XI for its metrology lab. The machine will be used to check customer workpieces produced in run-offs at Index's 50,000 sq ft demonstration and engineering facility here.

"With this high-end measuring machine, we will be able to prove the effectiveness of Index and Traub machining processes to our customers and assure them of our machines' ability to consistently produce top quality parts for their customers," said Jeffrey Reinert, Index president.

Leitz CMMs are ultra-high precision coordinate measuring machines for quick inspection of basic geometries (i.e. cylinder blocks, gear boxes), and most types of special geometries found in precision machined parts as produced by Index and Traub machines. These include mechanical parts, automotive parts, valve parts, electronic connectors as well as gears, camshafts, worms, screw compressors. Form inspection is fast and easy using Leitz 3D probe technology, integrated with high-speed-scanning which permits rapid collection of a large number of data points quickly.



Index has already used the Leitz machine to good effect in proving its machining processes produce parts that meet the quality specifications of its customers.

"Part of the value to us of having this particular CMM is to provide inarguable proof that machine performance is as we assert," said Reinert. "Leitz is a recognized world leader in high-precision measurement."

# Hewland

## EXPANDS GRINDING, INSPECTION CAPABILITIES

Hewland Engineering recently announced a multi-million pound investment in state-of-the-art spiral level grinding capability, due to arrive in autumn 2015.

The new Klingelnberg Oerlikon G60 Spiral Bevel Gear Grinding Machine and Klingelnberg P65 Gear Measuring Center will increase final-drive performance, durability and precision, while also increasing manufacturing capacity to provide clients with market-leading delivery times.

The G60 and P65 will utilize a closed-loop monitoring system to provide active feedback, ensuring every component can meet the demands of its application, be it in motorsport, aerospace, OEM or defense.

With the G60 capable of grinding forms up to 600 mm in diameter to consistent DIN 4 accuracy, the machine will enable production of spiral bevel gears to suit almost any application, while the P65 gear measuring center (with a capacity of 650 mm) ensures that all surfaces are machined to the exacting tolerances required in the precision manufacturing sectors.

With the capability to machine to fine (Formula One-grade) tolerances post-heat-treatment, the new machinery will deliver improvements in efficiency, reduced gearbox temperatures and increased component life.

For bespoke and made-to-drawing applications, new software will allow faster setup, with on-machine dressable grinding wheels negating the need for bespoke tooling. This will result in shorter lead times, improved quality and a reduction in up-front costs.

"The expansion of our grinding capabilities ensures we continue to provide components and transmissions of the utmost quality," said Hewland Company Chairman William Hewland. "Transmission efficiency is of paramount importance in our industry, particularly with the rapid emergence of Electric Vehicle technology. Hewland is already a global market leader in this field, as well as in the general motorsport sector, and this state-of-the-art machinery will herald a new era of performance for all present and future clients."



# Solar Atmospheres

## RECEIVES FIRST MEDACCRED ACCREDITATION

Solar Atmospheres, Inc. recently announced that it has become the first company to receive MedAccred accreditation.

Medical prime contractors are demanding that environmental conditions are controlled, processes validated, and the risk of foreign object debris (FOD) reduced. Performance Review Institute (PRI) states that MedAccred is an industry managed supply chain oversight program that bolsters patient safety. It does this through clarification of requirements and better identifying how they apply to critical processes used in the production of medical devices.

“Achieving MedAccred accreditation is not easy: It is one of the ways in which the medical device manufacturing industry identifies those suppliers capable of providing superior critical process manufacturing to the device industry,” said Joe Pinto, executive vice president and chief operating officer at PRI. “Solar Atmospheres has worked hard to obtain this status and they should be justifiably proud of it.

“PRI is proud to support continual improvement in the medical device manufacturing industry by helping companies such as Solar Atmospheres be successful and we look forward to continuing to assist the industry moving forward. I would like to add my personal congratulations to everyone at Solar Atmospheres, as the company has been actively involved in the MedAccred program for some time now, and volunteered to pioneer this process. Their positivity and diligence has paid off and I am delighted to award them the first ever MedAccred certificate.”

Benefits of MedAccred include: providing consistent/standardized critical process accreditation accepted by the medical device industry, resulting in fewer redundant onsite audits by multiple OEMs; conducting in-depth critical process audits that are compliant and consistent to accepted industry/technical standards and conducted by subject matter experts; providing greater visibility of the supply chain to all levels and sub-tiers that provide critical processes, consistent with regulatory requirements (e.g. FDA, ISO 13485, MDD, etc.); improving



# Spiral Bevel Gears

- Spiral & straight bevel gear manufacturing.
- Commercial to aircraft quality gearing.
- Spur, helical, splined shafts, internal & external, shaved & ground gears.
- Spiral bevel grinding.
- Midwest Transmissions & Reducers.
- ISO compliant.



Midwest Gear & Tool, Inc.  
15700 Common Rd., Roseville, MI 48066  
Tel: 586.779.1300 midwestgear@sbcglobal.net



ACCU-DRIVE, INC.  
610 West Pershing Rd.  
Chicago, IL. 60609



## PRECISION GEAR GRINDING

- Spur / Helical up to 59" O.D. – 26" Face
- Accurate quotes – Competitive prices – Fast turn-around
- Emergency “breakdown” support
- Support system for OEM parts
- Full complement of testing equipment for complete and comprehensive charting. Calibrated and certified on a regular schedule.

Trusted by OEM, MRO and Gear Job Shop customers for nearly two decades.

Your project is as important to us as it is to you.

**(773) 376-4906**

[www.Accudrv.com](http://www.Accudrv.com)  
[gears@accudrv.com](mailto:gears@accudrv.com)

**KISSsoft**  
Calculation programs for machine design

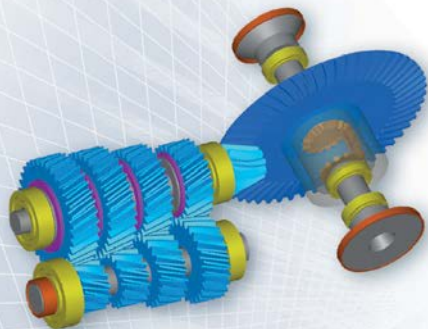

**NEW**  
Release  
03/2015

**KISSsoft Highlights**

- Risk assessment of flank fracture for cylindrical gears
- Contact analysis for bevel gears
- Planet carrier deformation with FE calculation
- Housing stiffness in KISSsys
- Modal analysis of shaft systems
- And many more ...

KISSsoft USA, LLC  
3719 N. Spring Grove Road  
Johnsburg, Illinois 60051  
Phone (815) 363 8823  
dan.kondritz@KISSsoft.com

Get your free trial version at  
[www.KISSsoft.com](http://www.KISSsoft.com)

flow down of OEM requirements to sub-tier suppliers; medical device industry-accepted and consistent technical requirements leading to process discipline, greater operational efficiency and continuous improvement resulting in higher quality and lower overall cost.

**Ipsen**

**AWARDED U.S. PATENT ON SEALING MECHANISM FOR A VACUUM HEAT-TREATING FURNACE**

Ipsen was recently awarded U.S. Patent No. 20,100,196,836 A1 for the development of a new shaft seal.

Chief Engineer Craig Moller, Chief Operating Officer Jake Hamid and Dr. W. Hendrik Grobler, the named inventors on the patent, began formulating this design seven years ago for use with Ipsen's TITAN vacuum furnace lines.



Today, this shaft seal is present in every TITAN furnace in the field – almost 200 to date. With this invention, Ipsen was able to locate the motor outside of the vacuum chamber, allowing it to be in a cooler and more stable environment. This relocation of the motor poses numerous advantages, including extended motor life and a longer interval between motor rebuilds. Since the installation of this shaft seal on the first TITAN unit in 2009, the TITAN furnaces have experienced thousands of hours of trouble-free operation.

In addition, now that the motor is outside in ambient air, users no longer have to use a step-down transformer for Argon cooling gas – as required by NFPA 86. Maintenance has also been simplified with users able to grease the motor's bearings, monitor the vibration of the motor and perform routine maintenance checks. This, combined with Ipsen's production and assembly process that integrates premium components, lowers the cost of ownership.

**BEYTA GEAR SERVICE**

**PUTTING  
A LIFETIME**

**OF**

**GEAR  
DESIGN  
EXPERIENCE**

**TO WORK FOR YOU**

- |                             |                            |
|-----------------------------|----------------------------|
| • Reverse engineering       | • Design reviews           |
| • Gearbox upgrades          | • Bid evaluations          |
| • Custom gearbox design     | • Tooling design           |
| • Specification development | • Customized gear training |
| • Project management        | • Equipment evaluation     |
| • Vendor qualification      | • Custom machine design    |

**Charles D. Schultz**  
**chuck@beytagear.com**  
**[630] 209-1652**

[www.beytagear.com](http://www.beytagear.com)

**July 14-16 – SEMICON West 2015** Moscone Center, San Francisco, CA. SEMICON West is the premier annual event for the global microelectronics industry, highlighting the latest innovations, products, processes, and services for the design and manufacture of today's most sophisticated electronics. SEMICON West showcases innovations across the microelectronics supply chain, from silicon to system and everything in between. From the latest research on the cutting-edge of transistor technology, to solutions breathing new life into legacy fabs, SEMICON West is the place to connect to what's new and what's next in microelectronics. For more information, visit [www.semiconwest2015.org](http://www.semiconwest2015.org).

**August 6-8 – Asia International Gear Transmission Expo 2015** As Asia's most influential, professional and authoritative gear industry event, GTE has been held 10 years in a row and during that time has obtained the affirmation of a large number of exhibitors and buyers. The exhibition will work with multiple marketplace platforms to create the Asia gear industry's most influential international showcase. With a planned area of 45,000 square meters, the exhibition expects more than 500 exhibitors and 40,000 professional visitors from home and abroad. For more information, visit [www.gte-asia.com](http://www.gte-asia.com).

**August 10-12 – MPIF's Basic PM Short Course** Penn Stater Conference Center Hotel, State College, PA. This intensive 3-day course is designed especially for you, if you are starting out in the field and looking for an introduction to powder metallurgy (PM); updating your knowledge of recent developments in PM; seeking to expand your current knowledge of the PM industry; a user of PM parts or are considering PM. This course is designed for engineers, tool designers, metallurgists, supervisors and technicians. For more information, visit [www.mpif.org](http://www.mpif.org).

**September 13-15 – TECHINDIA 2015** Bombay Exhibition Centre, Mumbai, India. TECHINDIA will be the ultimate facilitator for b2b cooperation between manufacturers and consumers of all hues connected to the engineering, machinery and manufacturing industry. This leading business event is co-located with five other industry events to make it an extended platform for metal, engineering, manufacturing and machine tools industry: World of Metal – International Exhibition on Metal Producing, Metal Processing and Metal Working Industry; CWE – International Exhibition on Cutting and Welding Equipment; IMEX – International Exhibition on Machine Tools and Engineering Products; UMEX – International Exhibition on Used Machineries; Hand Tools and Fasteners Expo – International Exhibition on Hand Tools and Fasteners. The collocation of industry events will maximize business opportunities for industry professionals. For more information, visit [techindia-expo.com](http://techindia-expo.com).

**September 21-23 – Gear Failure Analysis** Big Sky Resort, Big Sky, MT. Explore gear failure analysis in this hands-on seminar where students not only see slides of failed gears but can hold and examine those same field samples close up. Experience the use of microscope and take your own contact pattern from field samples. Cost is \$1,600 for members and \$2,100 for non-members. For more information, visit [www.agma.org](http://www.agma.org).

**September 21-25 – Basic Training for Gear Manufacturing Chicago, IL** The AGMA Training School for Gear Manufacturing will enable participants to become more knowledgeable and productive, teaching students to set up machines for maximum efficiency, to inspect gears accurately, and to understand basic gearing. For more information, visit [www.agma.org](http://www.agma.org).

**September 29-October 1 – 2015 Gear Manufacturing & Inspection** Hyatt Regency, Rochester, NY. This seminar provides the gear design engineer with a broad understanding of the methods used to manufacture and inspect gears and how the resultant information can be applied and interpreted in the design process. Following this seminar, participants will be able to identify methods of manufacturing external and internal spur, single and double helical, and bevel and worm gears, describe the methodology and underlying theory for basic manufacture and inspection of each, and much more. Cost is \$1,430 for member and \$1,930 for non-members. For more information, visit [www.agma.org](http://www.agma.org).

**October 18-20 – AGMA 2015 Fall Technical Meeting** Cobo Center, Detroit, MI. The AGMA 2015 Fall Technical Meeting (FTM) provides an outstanding opportunity for you to receive the latest research in the field, network with your peers, and learn about latest methods and cutting edge technologies in use in the gearing industry today. This year's FTM will feature 29 papers, presented in five sessions: Materials & Heat Treatment; Manufacturing; Gear Application; Lubrication, Efficiency, Noise & Vibration; and Gear Wear & Failure. For more information, visit [www.agma.org](http://www.agma.org).

**November 3-5 – 2015 Detailed Gear Design Beyond Simple Service Factors** Hyatt Place Las Vegas, Las Vegas, NV. This course explores all factors going into good gear design from life cycle, load, torque, tooth optimization, and evaluating consequences. Students should have a good understanding of basic gear theory and nomenclature. Interact with a group of your peers and with a talented and well-respected instructor who will push your thinking beyond its normal boundaries. Cost is \$1,395 for members and \$1,895 for non-members. For more information, visit [www.agma.org](http://www.agma.org).

**November 13-19 – 2015 International Mechanical Engineering Congress & Exposition** Houston, TX. ASME's International Mechanical Engineering Congress and Exposition (IMECE) is the largest interdisciplinary mechanical engineering conference in the world. IMECE plays a significant role in stimulating innovation from basic discovery to translational application. It fosters new collaborations that engage stakeholders and partners not only from academia, but also from national laboratories, industry, research settings, and funding bodies. Among the 4,000 attendees from 75+ countries are mechanical engineers in advanced manufacturing, aerospace, advanced energy, fluids engineering, heat transfer, design engineering, materials and energy recovery, applied mechanics, power, rail transportation, nanotechnology, bioengineering, internal combustion engines, environmental engineering, and more. For more information, visit [www.asmeconferences.org](http://www.asmeconferences.org).

- 3M Abrasives** — page 18  
[www.3M.com/PrecisionGTAug](http://www.3M.com/PrecisionGTAug)
- A.G. Davis/AA Gage** — page 21  
[www.agdavis.com](http://www.agdavis.com)
- Accu-Drive Inc.** — page 67  
[www.accudrv.com](http://www.accudrv.com)
- AGMA (Gear Expo)** — page 29  
[www.gearexpo.com](http://www.gearexpo.com)
- All Metals & Forge Group, LLC** — page 33  
[www.steelforge.com](http://www.steelforge.com)
- Arrow Gear** — page 19  
[www.arrowgear.com](http://www.arrowgear.com)
- B&R Machine & Gear Corp.** — page 17  
[www.brgear.com](http://www.brgear.com)
- Beyta Gear Service** — page 68  
[www.beytagear.com](http://www.beytagear.com)
- The Broach Masters & Universal Gear** — page 14  
[www.broachmasters.com](http://www.broachmasters.com)
- Circle Gear** — page 71  
[www.circlegear.com](http://www.circlegear.com)
- DTR Corp.** — page 25  
[www.dragon.co.kr](http://www.dragon.co.kr)
- Excel Gear** — page 22  
[www.excelgear.com](http://www.excelgear.com)
- Forest City Gear** — page 7  
[www.forestcitygear.com](http://www.forestcitygear.com)
- Forkardt** — page 34  
[www.forkardt.us](http://www.forkardt.us)
- Gear Expo (AGMA)** — page 29  
[www.gearexpo.com](http://www.gearexpo.com)
- The Gear Machinery Exchange** — pages 70, 71  
[www.gearmachineryexchange.com](http://www.gearmachineryexchange.com)
- Gleason Corp.** — pages 36-37  
[www.gleason.com](http://www.gleason.com)
- Goldstein Gear Machinery** — pages 70, 71  
[www.goldsteingearmachinery.com](http://www.goldsteingearmachinery.com)
- Hans-Jürgen Geiger Maschinen-Vertrieb GmbH** — page 39  
[www.geiger-germany.com](http://www.geiger-germany.com)
- Hardinge Grinding Group** — page 13  
[www.hardinge grindinggroup.com](http://www.hardinge grindinggroup.com)
- Index Technologies** — page 71  
[www.gallenco.com](http://www.gallenco.com)
- Ingersoll Cutting Tools** — page 23  
[www.ingersoll-imc.com](http://www.ingersoll-imc.com)
- Ipsen International** — Inside Back Cover  
[www.ipseusa.com](http://www.ipseusa.com)
- Kapp Technologies** — page 3  
[www.kapp-usa.com](http://www.kapp-usa.com)
- KissSoft** — page 68  
[www.kisssoft.com](http://www.kisssoft.com)
- Klingelberg** — Outside Back Cover  
[www.klingelberg.com](http://www.klingelberg.com)
- Koro Sharpening Service** — page 71  
[www.koroinc.com](http://www.koroinc.com)
- Liebherr** — page 5  
[www.liebherr.com](http://www.liebherr.com)
- Luren Precision** — page 31  
[www.lurenusa.com](http://www.lurenusa.com)
- McInnes Rolled Rings** — page 27  
[www.mcinnesrolledrings.com](http://www.mcinnesrolledrings.com)
- Micro Surface Corp.** — page 71  
[www.ws2coating.com](http://www.ws2coating.com)
- Midwest Gear & Tool Inc.** — page 67  
[midwestgear@sbcglobal.net](mailto:midwestgear@sbcglobal.net)
- Mitsubishi Heavy Industries** — page 8  
[www.mitsubishigearcenter.com](http://www.mitsubishigearcenter.com)
- Nachi America** — page 16  
[www.nachi-america.com](http://www.nachi-america.com)
- Nordex Inc.** — page 32  
[www.nordex.com](http://www.nordex.com)
- Pentagear Products** — page 24  
[pentagear.com](http://pentagear.com)
- Phoenix Tool & Thread Grinding** — page 71  
[www.phoenixthreadgrinding.com](http://www.phoenixthreadgrinding.com)
- Presrite Corp.** — page 26  
[www.presrite.com](http://www.presrite.com)
- Radiac Abrasives** — page 35  
[www.radiac.com](http://www.radiac.com)
- Rave Gears & Machining** — page 11  
[www.ravegears.com](http://www.ravegears.com)
- Reishauer** — page 15  
[www.reishauer.com](http://www.reishauer.com)
- Schnyder S.A.** — page 4  
[www.hanikcorp.com](http://www.hanikcorp.com)
- Star SU LLC** — pages IFC-1, 71  
[www.star-su.com](http://www.star-su.com)
- Suhner Manufacturing** — page 4  
[www.suhner.com](http://www.suhner.com)
- TECO Werkzeugmaschinen GmbH & Co. KG** — page 35  
[www.teco-germany.com](http://www.teco-germany.com)
- Weldon Solutions** — page 12  
[www.weldonsolutions.com](http://www.weldonsolutions.com)

# GLEASON GEAR EQUIPMENT

## GENERATORS

**Model 645 Hypoid Generators**, loaded with every option, from Aircraft 1980

**Model 26 Hypoid**, Rough & Finish Cams, Modified Roll, from Aircraft

**Model 642 G-Plete, Hypoid** 13" (330 mm), Helical Motion, FORMATE, Excellent, 1982

**Model 116 & 118 Hypoid**, Rough & finish Cams, FORMATE, from Aircraft 1967 & 1966

**Model 106 & 108 Hypoid**, Rough & finish Cams, Helical Motion, FORMATE, from Aircraft 1960 & 1964

**Model 14 Coniflex Straight Rough & Finish**, Complete

## TESTERS

**Model 27M Hypoid** 30.5" (925 mm), #60/#39 Tapers, From Aircraft, 1961

**Model 502 Hypoid** 10.5"/6" (270 mm/155 mm) #39/#14 Tapers From Aircraft, 1964

**Model 13 Universal**, 13" (335 mm) #18 From Aircraft

**Model 6 Split Head Universal**, 7.5" (190 mm) From Aircraft, 1958 & 1966

**Model 6 Solid Head Universal**, 7.5" (190 mm), From Aircraft



**GEAR  
MACHINERY  
EXCHANGE.COM**

[www.gearmachineryexchange.com](http://www.gearmachineryexchange.com)



**KORO** for Quality  
**Hob Sharpening Service**

- ◆ Quick Turnaround 2 Day Service
- ◆ Spur Shaper Cutter Sharpening
- ◆ HSS & Carbide Hob with center hole and straight flutes
- ◆ Thin Film Coatings
- ◆ Length up to 7 inches
- ◆ Diameter up to 5 Inches
- ◆ Precise rake and spacing guaranteed to AGMA standards
- ◆ **RUSH SERVICE AVAILABLE**

Koro Sharpening Service  
 9530 85<sup>th</sup> Ave North  
 Maple Grove, MN 55369  
 763-425-5247  
 info@koroinc.com

**PHOENIX**  
 TOOL & THREAD GRINDING

- CNC External Thread Grinding Specialists
- Emergency Service Available
- Any thread form
- Any lead
- Multiple starts

4760 Briar Rd, Cleveland, OH 44135  
 Phone: 216-433-7008 Fax: 216-433-7067  
 Phoenixgrinding@gmail.com  
 www.PhoenixThreadGrinding.com

**Sharpening Service**  
 for hobs, milling cutters, shaper cutters,  
 shaving cutters and broaches

Service locations in:

- Hoffman Estates, IL  
 Tel: 847.649.1450 Fax: 847.649.0112
- East Tawas, MI  
 Tel: 989.362.0414 Fax: 989.362.2720
- Querétaro, México  
 Tel: 52 442 217 34 45  
 Fax: 52 442 217 34 46

sales@star-su.com  
 www.star-su.com

**QUALITY CUSTOM GEARING!**

Documented  
 Quality Control Program

Inspection Lab  
 including Complete  
 Gear Tooth Diagnostics

**Tooth Cutting, Grinding & Shaving Services Available**

All Sizes & Configurations

- Reverse Engineering
- Design Analysis
- Complete Machine Shop Including CNC Machining

**Circle Gear and Machine**  
 Quality Custom Gearing Since 1951

1501 South 55th Ct. • Cicero, IL 60804  
 Ph: 708-652-1000 • Fax: 708-652-1100

Please email your inquiries to sales@circlegear.com • www.circlegear.com

**HEY #3 Milling & Centering Machines,**  
 27"cc, 15HP, 1980  
 51"cc, 10HP, 1980

**GEAR MACHINERY EXCHANGE.COM**

www.gearmachineryexchange.com

**SHARP HOBS**  
 Change Downtime To Productivity

You Need Your Tools Back **FAST**  
 – Eliminating Downtime & Tuned To Meet or Surpass Original Design Specs and That's Where We Come In

- Stripping & Re-Coating
- Gear Shaper Sharpening
- Milling Cutter Sharpening
- Gear Tool Certifications

**Index Technologies**  
 Gear Tool Reconditioning

Tel: 216-642-5900 • Fax: 216-642-8837 • 5755 Canal Road • Valley View, OH 44125  
 Email: gallen@gallenco.com [WWW.GALLENCO.COM](http://WWW.GALLENCO.COM)

**Dry Lube Coating**

- WS<sub>2</sub>
- MoS<sub>2</sub>
- PTFE

Call on **MicroSurface** for unbeatable prices!

CALL: (408) 723-0700  
 info@ws2coating.com

**MICRO SURFACE CORPORATION**

# THE FIXIE FIXATION

Introducing the bicycle craze that literally can't be stopped

Erik Schmidt, Assistant Editor

In David Koepp's 2012 bicycle messenger action-thriller *Premium Rush* (yes, apparently that is an actual genre), Joseph Gordon-Levitt's beleaguered hero Wilee deadpans this startling line through clenched teeth:

"I like to ride. Fixed gear. No brakes. Can't stop. Don't want to, either."

Well, pardon me, Mr. JGL, but I so do desire the ability to pause my single-track vehicle when I'm hurtling down the street towards oncoming traffic. It helps prevent certain undesirable afflictions, like, you know, death.

I only mention this because it has recently come to my attention that there exists a whole community of kinetic individuals who are very much against the idea of coming to a complete stop—or at least easily. As such, these forward-thinking (and moving) folk have devised a way to transform their early morning commutes and leisurely weekend joy rides into nonstop jaunts towards bodily harm.

Ladies and gentleman, I give you the "fixie."

A fixie, according to our reliable friends over at Wikipedia, is "a bicycle that has a drivetrain with no freewheel mechanism. A fixed-gear drivetrain has the drive sprocket threaded or bolted directly to the hub of the back wheel, so that the rider cannot stop pedaling. When the rear wheel turns, the pedals turn in the same direction. This allows a cyclist to apply a braking force with the legs and bodyweight, by resisting the rotation of the cranks. It also makes it possible to ride backwards, although learning to do so is much more difficult than riding forward.

"As a general rule, fixed-gear bicycles are single-speed. A derailleur cannot be fitted because the chain cannot have any slack. Most fixed-gear bicycles only have a front brake, and some have no brakes at all."

The appeal here, I believe, is that riding without a freewheel is *more organic* and allows the rider to become *better synced* with the road. I put emphasis on those phrases because they could be subbed out for the word "cooler" and the sentence would more or less read the same.

Perhaps I'm being stuffy, but this fixie fixation is what is commonly referred to as a trend. As is the case with all trends, people who adhere to them are trying to be *trendy* (yes, the aforementioned rule applies here too).

That's not hating—it simple semantics.

The fixie, of course, is nothing new. But they are newly fashionable, surging into mainstream counter culture (which in and of itself is a paradox, but that's the kind of topsy-turvy world we live in) over the last few years thanks to the aggressive tastes of urbanite hipsters—a newfangled offshoot of the yuppie that possess a mutating, trans-Atlantic melting pot of styles and behaviors.

Hipsters, essentially, are both the heralds and gatekeepers of popularity. They usher in new "it" items every so often and then stand guard over a taut velvet rope, deciding disdainfully who is and isn't allowed into their exclusive company.

And that brings us back to the fixie, which is the coolest thing on two wheels and a predominant and vital fixture of the current hipster ethos.

I, for one, don't get it, but I guess it isn't surprising that there exists a contingent of people relishing yet another chance to stand out from the crowd. The fixie is most certainly great coffee shop talk—I can picture bearded, slick-haired youths sipping espresso and lovingly describing the fluorescent paint job on their Cinelli MASH Histogram frame to the local barista as I type this.



It should be noted, for the sake of fairness, that I've always been a bit of a cycling pessimist. I crashed a lot as a kid (balance issues I think, or perhaps the sun was just always in my eyes), so the dream of ever winning the Tour de France, much less avoiding the neighbors' bramble bushes, died fairly young. And on the rare occasion I do saddle up on a Schwinn and take on the scenic forest preserves of southern Illinois, I ride slow and steady and coast whenever there's the slightest decline in terrain.

So no, I will not be joining this brakeless revolution. I don't have the mind or the mettle for it.

But if you're up for a challenge, go ahead and give a fixie a whirl. No freewheel. No brakes. No stopping. And a rare sneak peek behind the velvet rope.

Sounds terribly unappealing from my boring vantage point on two legs, but you're probably a braver (and "cooler") soul than I. ⚙️

# Batch Furnace System – Single-Chain Model



# ATLAS

## Video Brochure

Ipsen's ATLAS atmosphere furnace line, which is manufactured and serviced in the USA, combines the achievements of past atmosphere furnaces with the evolutionary innovations of the future. This video showcases the single-chain model's features, benefits and technological advantages, including:

- Load size of 36" x 48" x 38" (W x L x H)
- Improved functionality and precision of the quenching system – TurboQuench™
- Intelligent controls with predictive process capabilities – Carb-o-Prof®

Call Our Sales Team

**800-727-7625**

International: +1-815-332-2695

Ask for Rene, ext. 2695

Scan the QR code to view the video:



or visit

[IpsenUSA.com/ATLAS-Video-Brochure](http://IpsenUSA.com/ATLAS-Video-Brochure)



# PERFECT MATCH.

**MAXIMUM ACCURACY SOLUTIONS  
FOR GEAR MANUFACTURERS  
BY KLINGELBERG**



Only a perfect pass, a perfect catch and an optimal score make a perfect game. Such are Höfler gear grinders and Klingelberg measuring centers. For example the Höfler RAPID 1250K with a special spindle for smaller grinding wheels increasing your application range and the Klingelberg P 100L measuring center safeguarding highest precision – perfectly matched machines. A dream team within the Klingelberg system.

Become a player in cylindrical gear technology – with the perfect Klingelberg match.

**Perfect Match:**  
[www.klingelberg.com](http://www.klingelberg.com)  
[www.hofler.com](http://www.hofler.com)

**KLINGELBERG America, Inc.**  
p. +1 734 470 6278  
e. [usa.sales@klingelberg.com](mailto:usa.sales@klingelberg.com)

**NEXT FAIRS:**



EMO Milano, Oct 05-10, 2015  
Fieramilano  
Milano, Italy



GEAR EXPO, Oct 20-22, 2015  
Cobo Center  
Detroit, MI, USA

SUBJECT TO CHANGES.