

INFLUENCE OF COATINGS AND SURFACE IMPROVEMENTS ON THE LIFETIME OF GEARS

Franz Joachim, Norbert Kurz and Bernhard Glatthaar

Abstract

Surface coatings or finishing processes are the future technologies for improving the load carrying capacity of case hardened gears. With the help of basic tests, the influence of different coatings and finishing processes on efficiency and resistance to wear, scuffing, micropitting, and macropitting is examined.

Reports on experience with coated gears in different transmissions are depicted. In the past, coated transmission gears have been used to repair inadequate gear designs. Future application of such technologies will depend on verified test data and will be selected only if the technologies are reliable and cost-effective.

Introduction

The development of vehicle transmissions is characterized by continuously increasing levels of torque and power, lightweight designs, increased service lives, improved efficiency and more stringent noise requirements. Over the last few years, the opportunities provided by conventional technologies to increase performance have all been fully exploited. Future technologies for increasing gear flank load capacity are surface coatings or finishing processes. These possibilities, however, are just starting to be developed and are still insufficiently investigated. To evaluate their potential for optimization in terms of gear load capacity and efficiency, a number of fundamental investigations have been conducted within ZF (Refs. 1–3). Test results obtained with physical vapor deposition (PVD) hard coatings and a superfinishing procedure are reported below, such as superfinishing and honing.

Tribological System

The lubrication status of two meshing gear flanks is characterized by limit/mixed friction and hydrodynamic lubrication (see Fig. 1). This is greatly influenced by the operating conditions, lubricant, gear geometry and surface characteris-

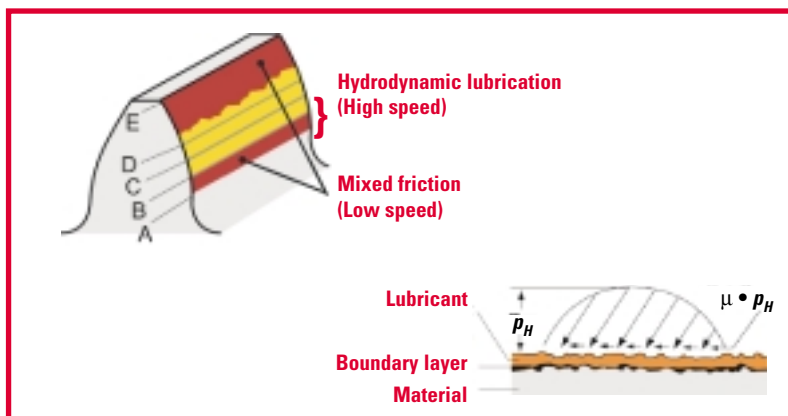

Figure 1—Gear flank lubrication model.

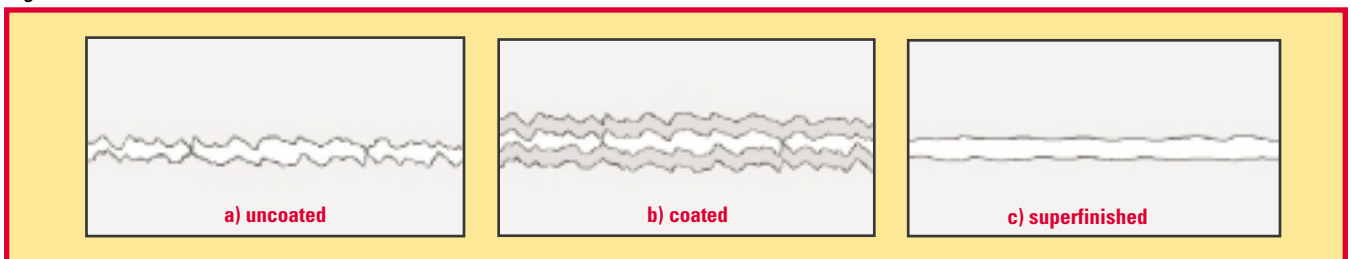

Figure 2—Characteristic surface treatments.

tics. At low pitch-line velocity, limit and mixed friction occur; and at higher pitch-line velocity, an elasto-hydrodynamic (EHL) film of lubricant may form.

Figure 2 shows comparisons of the geometry of contact zones (in diagrammatic form) for the following surfaces: uncoated, coated and superfinished. The coated surface shown here is a coating true to both the contour and surface. Solid body friction occurs on some of the peaks in roughness on both “rough” uncoated and coated surfaces. However, the coating represents a specifically applied layer of surface protection to obtain favourable friction and run-in characteristics. The superfinished surfaces are separated by an EHL film, and friction is dominated by shearing of the lubricant film.

In all three instances, the effect of the surface response layer is most significant. The form of this layer depends on the lubricant, condition of the surface, and chemical reactions. It can also affect the friction characteristics.

The effect of friction on Hertzian stresses is shown in Figure 3. This shows that with increasing friction, the maximum subsurface stress moves closer to the surface and therefore encourages the emergence of surface fatigue damage, such as micropitting and macropitting.

Surface Treatment Procedure

As mentioned above, gear flank load-bearing capacity is determined by a number of factors. In addition to material, heat treatment, gear geometry corrections and lubricant, these include surface treatment procedures such as coating and finishing processes. The causal relationships between gear flank load-bearing capacity, coatings and finishing processes are illustrated in Table 1. In the past, gear coatings primarily took the form of soft layers used to improve running-in characteristics and scuffing resistance. In the first instance, this involved phosphating and copper plating. For final finishing of gears and splines, various types of grinding, honing and superfinishing can be employed.

The investigation results itemized in the following section focus primarily on PVD coating and chemically accelerated superfinishing.

Coatings. The main focus will be on tungsten carbon carbide (WC/C) and amorphous boron carbide (B4C) (Refs. 4–5).

The tungsten carbon carbide layer WC/C is a metallic-hydrocarbon layer (Me-C:H), which is increasingly used in automotive construction and mechanical engineering to reduce wear. These

Gear failures usually start at the surface or in the outer layer.

- adhesive wear
- scuffing
- micropitting
- macropitting

Table 1—Methods to Increase Gear Flank Durability.

Influence	Coatings	Superfinishing
reduced coefficient of friction	X	X
running-in effect	X	(X)
boundary layer, separation, strength	X	(X)
corrosion protection	X	

* Without Parentheses: Perfectly applicable; With Parentheses: Only partially applicable

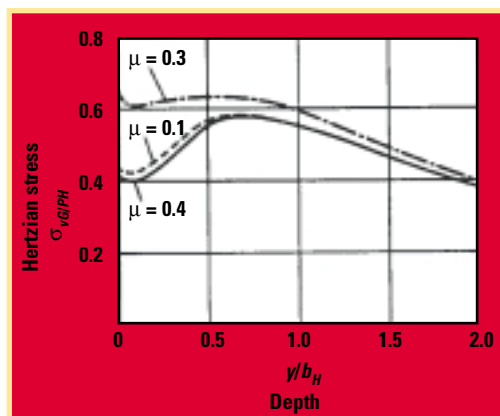

Figure 3—Influence of friction on Hertzian stress.

Table 2—Characteristics of WC/C and B4C.

Coating	WC/C	B4C
Coating material	tungsten, carbon	boron, carbon
Coating design	lamellar	amorphous
Coating temperature	150–250°C	≈120°C
Coating thickness	1–4 μm	≈ 2 μm
Hardness	800–1,600 HV	> 3,000 HV
Elastic modulus	0.8–1.6 • 10 ⁵ N/mm ²	
coefficient of friction	coating against steel:	dry 0.25
		mixed friction/drop lubrication 0.04
	steel against steel (uncoated):	dry > 0.60
		mixed friction/drop lubrication 0.15
		EHL lubrication 0.05

layers are applied using a PVD process which permits coating and material temperatures less than 200°C and therefore makes the coating of case hardened components possible. The layer is characterized by high levels of hardening, a low friction coefficient and high elasticity. The characteristics of WC/C are shown in Table 2.

The typical layer structure is shown in Figure

Dr.-Ing. Franz Joachim

is senior manager—gear development in corporate research & development at ZF Friedrichshafen AG, located in Friedrichshafen, Germany. A mechanical engineer, he supervises gear design and development.

Dr.-Ing. Norbert Kurz

is manager of the gear laboratory in corporate research & development at ZF Friedrichshafen. As manager, he's responsible for the laboratory's performing of basic gear tests, including gear load capacity and gear noise.

Dipl.-Ing. Bernhard Glatthaar

works in the gear laboratory in corporate research & development at ZF Friedrichshafen, performing basic tests of gears.

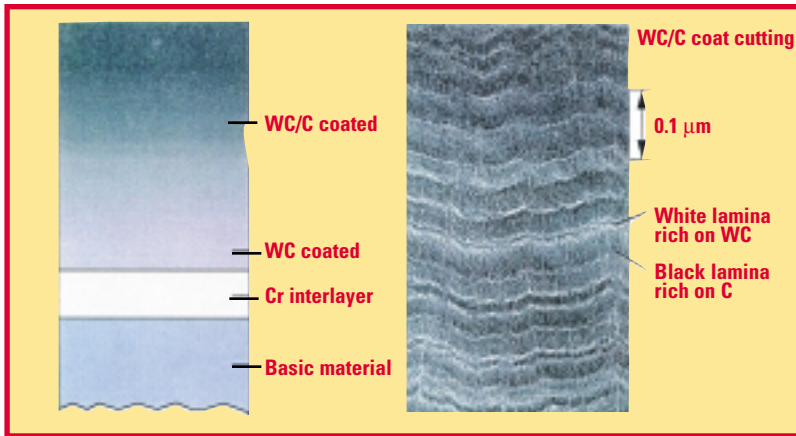

Figure 4—WC/C layer structure, according to Balzers.

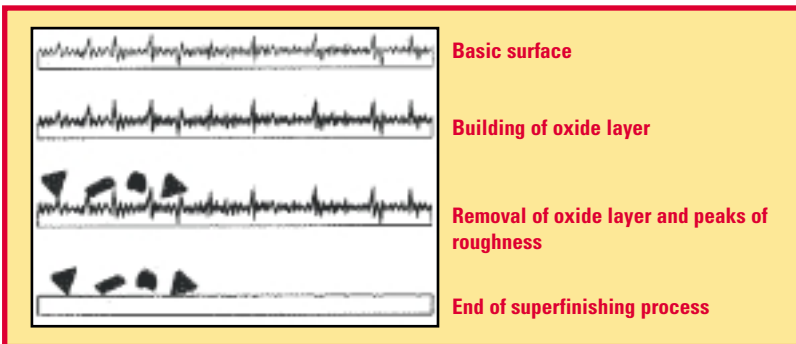

Figure 5—Principle of chemically accelerated superfinishing (Ref. 6).

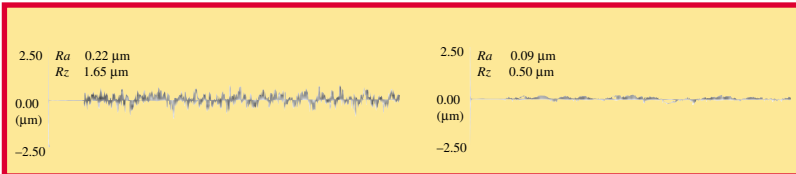

Figure 6—Roughness before and after superfinishing (FZG-C-gear).

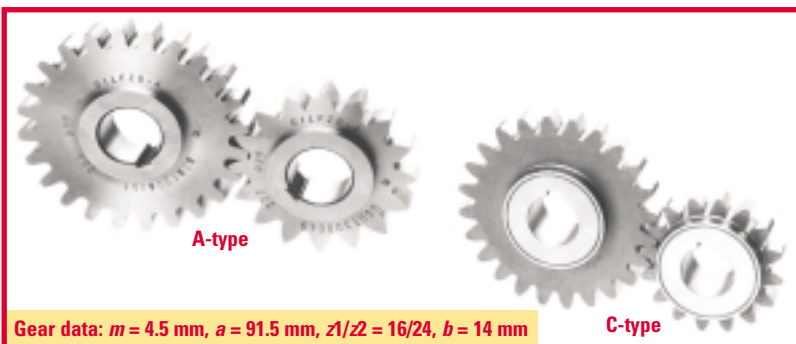

Figure 7—FZG test gears.

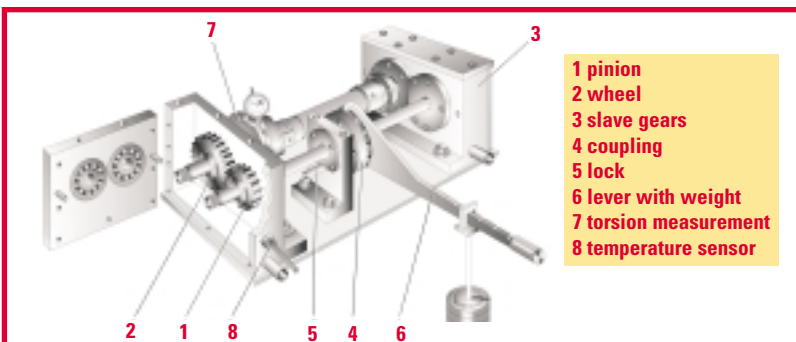

Figure 8—FZG gear tester—test equipment for basic gear tests.

4. This is a lamellar layer structure in which carbide and carbon-rich phases alternate at intervals of a few atoms. This produces good antifriction characteristics. The layer is true to the contour and does not notably modify the surface roughness.

B4C is applied using a PVD process similar to that used for WC/C. This layer has a substantially higher hardness level than WC/C.

The properties of both layers are defined in Table 2.

Chemically accelerated superfinishing. Standard superfinishing uses grinding particles to abrasively remove peaks of roughness, whereas chemically accelerated superfinishing uses a fluid compound (Ref. 6). This creates an oxide layer on the workpieces, which the grinding bodies continuously remove from the surface together with the peaks of roughness. For the principle behind the procedure, refer to Figure 5. Once the required surface quality has been reached, the oxide layer is removed using a second fluid compound. The reduction in roughness depends on the initial roughness and period of superfinishing. Examples of roughness measurement plots of ground gear flanks before and after superfinishing are shown in Figure 6.

Fundamental Investigations

Gears, test rig, test procedure. Type FZG-A and FZG-C gears were used for the comparative tests (see Fig. 7). The FZG-A gear is a standard test gear (DIN 51354) used for scuffing tests. The gear is designed especially for high sliding speeds and therefore responds with particular sensitivity to scuffing damage. The FZG-C gear is standardized and is used for macropitting, wear, and micropitting tests. The gear geometry has balanced specific sliding. Both gear types have no modifications (crowning, tip relief) and are produced by ZF according to specifications.

The widely used FZG gear test rig is employed when conducting gear tests (see Fig. 8).

Various gear test procedures were used to investigate the load capacity and efficiency. These will only be described briefly here. The most important test parameters are listed in Table 3.

During the FZG test to investigate scuffing load capacity, the loading and pressure are gradually increased at intervals of 15 minutes (load stages 1–12) until scuffing occurs.

The FZG macropitting test is used to evaluate the macropitting load capacity. The transmission is operated under constant operating conditions until macropitting occurs (maximum up to 300 hrs or 40×10^6 load cycles). Low speed wear

characteristics are evaluated in the ZF wear test. Constant operating conditions are maintained over specific runtime intervals and the gear's loss in weight determined.

The ZF efficiency test is used to determine the gear's power loss and the gear friction coefficient. The input torque induced in the test rig is measured under different test conditions.

Scuffing load capacity. Scuffing load capacity is also affected by the characteristics of the flank surface in addition to the operating conditions, gear geometry, lubricant and material. All measures resulting in a lower flank temperature (reduction in friction) favor high scuffing load capacity. This also applies to the two hard layers investigated and the superfinishing, as is shown in Figure 9.

This produces a clear increase in scuffing load capacity for the WC/C and B4C layers. An improvement of approximately two damage load stages corresponds to an increase in torque capacity of approximately 50%.

In this instance, the change in oil temperature over the individual load stages is also evaluated. Figure 10 shows the oil temperature established in each instance towards the end of the runtime of a load stage (output temperature before start of a load cycle is always 90°C).

It can be noted that a lower oil temperature occurs with both the coated and superfinished gears than on the uncoated gears. This is due to the improved friction characteristics. The fact that superfinished gears, with very favorable temperature characteristics, fare less well than those with WC/C or B4C in terms of scuffing resistance, must be due to the fact that the coating material itself (regardless of the formation of a film of lubricant) is less prone to scuffing than the base material.

Macropitting load capacity, formation of micropitting. In the FZG macropitting test, a clear increase in load capacity was found for coated gears when compared with uncoated gears, Figure 11, but only if both gears are coated. This resulted in increases in lifetime by a factor of 2–3.

The poor relative performance of the superfinished gears has not yet been clarified. Despite better friction characteristics, no improvement is gained from superfinishing when compared with the "rough" initial condition. There could be many reasons for this. Since the test gears have no profile modifications, very high levels of pressure arise at the start of meshing. Regardless of the surface condition, this will only permit boundary

Test designation	Gear type	Pitch-line velocity (m/s)	Temperature (°C)	Pressure σ_{H0} (N/mm ²)	Test procedure
FZG scuffing test	A	8.3	90 (Start temp.)	135–1,730	15 min/Load Stage (LS); (max. 12 LS)
FZG macropitting test	C	8.3	90	1,530	max. 300 hrs
ZF wear test	C	0.03	80	2,035	20+40+40 hrs
ZF efficiency test	C	8.3	20/.../100	1,190	about 20 min/ Temperature stage

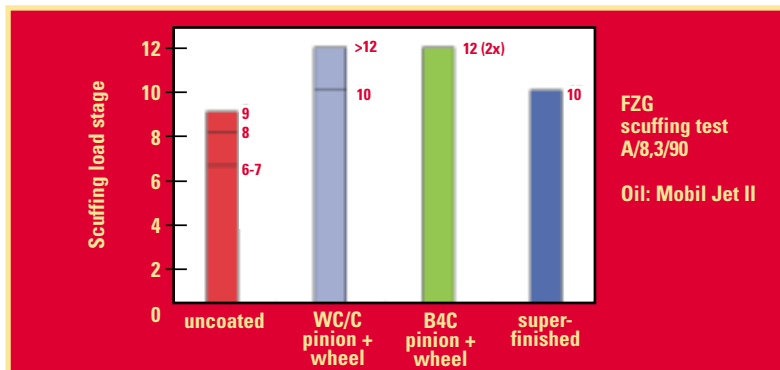

Figure 9—Scuffing resistance.

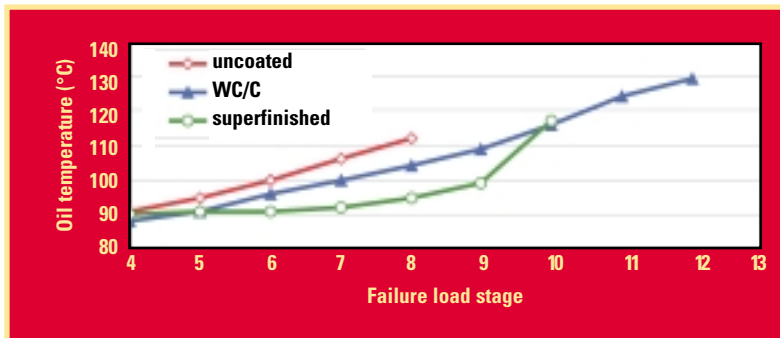

Figure 10—Temperature in the FZG scuffing test.

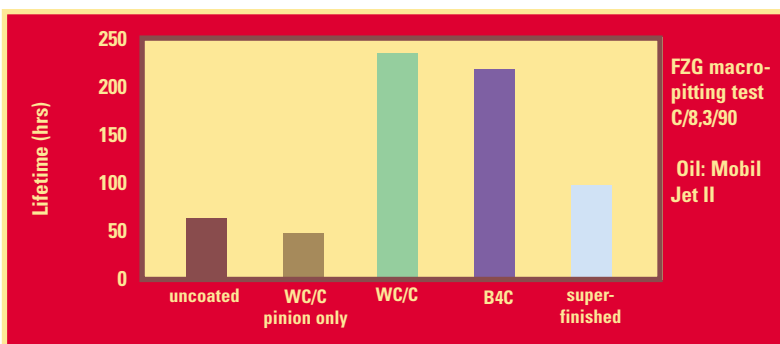

Figure 11—Macropitting test results.



Figure 12—Macropitting failure.

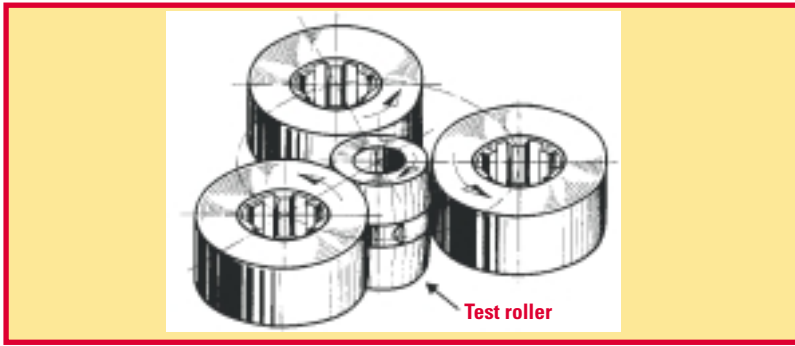

Figure 13—Principle of ZF roller test rig.

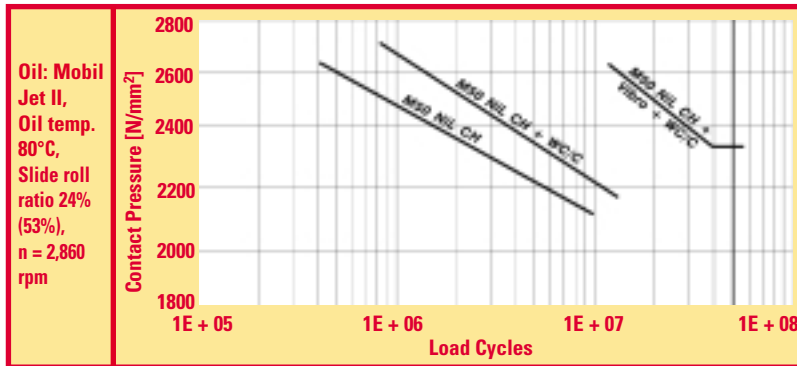

Figure 14—ZF roller tests with WC/C-coated rollers.

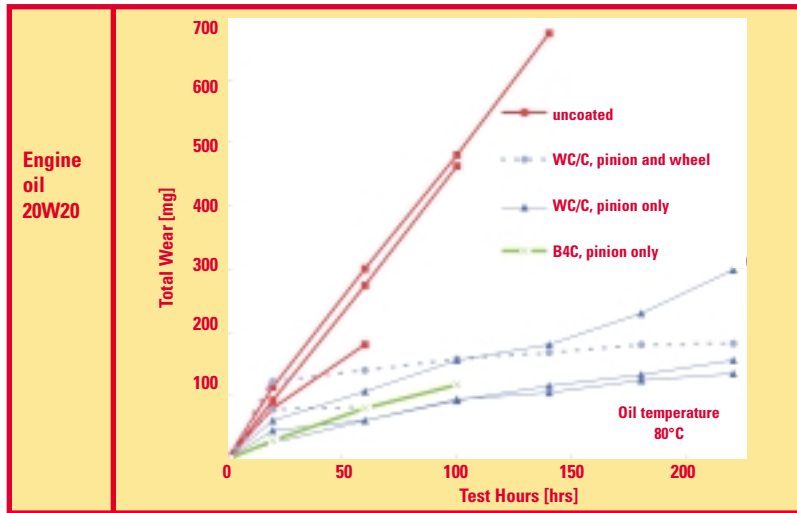

Figure 15—Results of the slow speed wear test.

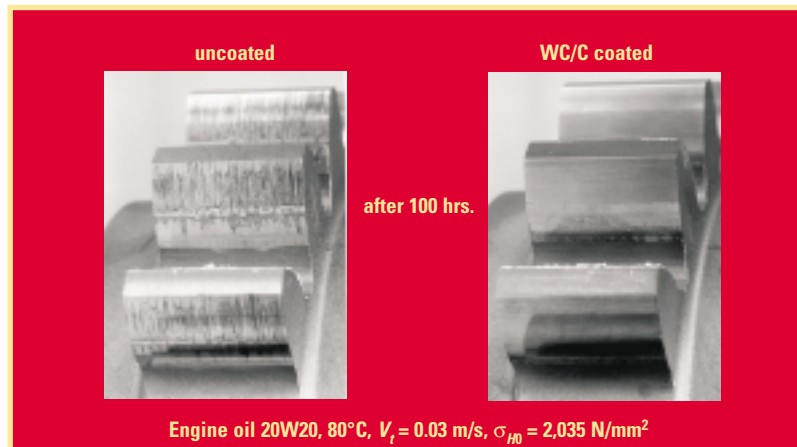

Figure 16—Gear flank surfaces after slow-speed wear test.

lubrication, and the friction characteristics are therefore mainly the same in both untreated and superfinished conditions. Another possible cause may be metallographic surface changes during superfinishing, caused by chemical action which takes place during the superfinishing machining (formation of oxide layer). However, this has not been proven, and more detailed investigations are still required on this matter.

The macropitting damage pattern is the same for all gears investigated. Figure 12 shows an example of a comparison of an uncoated gear and a WC/C-coated gear. As usual, macropitting occurs in the area of negative slip, with WC/C only after approximately 2–3 times the other run time. With the WC/C gear, machining/grinding marks can still be seen after this relatively long run time. Most of this will have already been removed after approximately 30% of the run time on the uncoated gears.

Investigations to compare the macropitting load capacity were also conducted as part of the research project ASETT (The Development of Advanced Surface Engineering Techniques for Future Aerospace Transmissions) sponsored by the European Commission (Ref. 3). The case hardened aviation steel M50NiL (AMS 6278) was tested in what are commonly referred to as ZF roller tests (see Fig. 13). An increase in load capacity (by a factor of 2–3) was obtained with the WC/C coating when compared with that of the uncoated initial condition (see Fig. 14). When the coating process is preceded by superfinishing, a further substantial increase in service life was achieved. The combination of superfinishing and a hard material layer (CH+Vibro+WC/C) achieved an increase in service life in untreated condition equivalent to a factor of 10–15.

Wear. Wear occurs mainly when the slide partners are incompletely separated at low circumferential speeds (< 0.5 m/s), where only an insufficient film of lubricant is able to form. Possible remedial measures in this instance could be: to increase the surface hardness, to reduce the surface roughness or to optimize the lubricant (increased viscosity, suitable additives).

Low-speed wear tests were conducted to investigate the extent to which the wear characteristics of gears are influenced by a hard material layer.

Figure 15 shows the positive influence of WC/C and B4C on wear resistance, whereby the material removal resulting over the test run time

is noted in milligrams (in total for both pinion and gear). The removal for the coated gears is approximately 5 times less than that for the uncoated gears. It is interesting to note that, in this instance, simply coating one slide partner is sufficient and coating both partners did not result in any further improvement.

Figure 16 shows the gear flank surfaces after 100 hours of operation in the low-speed wear test. The uncoated gear stands out here because of the severe abrasive wear grooves running in parallel with the gear height. The coated gears, on the other hand, did not display any abrasive wear, and the flanks have no signs of damage.

Efficiency. The efficiency of a transmission is primarily determined by friction losses in gear meshing. This is mainly dependent on gear geometry, operating conditions, lubricant, and surface quality (roughness) of the gear flanks.

The potential for reducing friction or improving efficiency, which can be gained by coating or superfinishing gears, is shown in Figures 17 and 18. The gear friction coefficient determined using the gear efficiency test is noted here as a characteristic reference number which is proportional to the loss of gear power.

Both the WC/C layer and the superfinishing give reductions in friction of up to 30%. These improvements are comparable to those obtained with “untreated” flank surfaces when changing from mineral-based oil to synthetic oil. Significant improvements can also be gained with the WC/C layer itself when using synthetic oil (see Fig. 18).

Transmission Applications/ Real-Life Examples

Based on the results from fundamental investigations, application investigations were also conducted on transmissions. This involved particularly critical applications where, for example, slow-speed wear occurred or, in isolated cases, where enhanced performance was required.

Table 4 illustrates coatings for different transmissions, problem definitions and applications.

Very positive results were obtained when tackling problems involving slow-speed wear. For example, with a concrete mixer transmission, shown in Figure 19, wear was almost completely eliminated on a slow-running and wear-prone planetary gear stage. This elimination was achieved by coating only the sun gear. In contrast to this, it did not prove possible to solve the problems of fretting corrosion in a commercial vehicle transmission by applying a hard material

coating.

In the case of macropitting-related damage patterns, only slight improvements were achieved. In some cases, problems with coating adhesion (bonding) were encountered. Possible causes for this might have been high levels of local contact pressure, which might have culminated in failure (tearing away) of the coating layer.

Positive results were achieved when tackling a problem of micropitting in a power-splitting tractor transmission. Noise problems were encountered in a planetary stage. These were caused by severe cratering on the sun gear, resulting from micropitting (see Fig. 20). Given that micropitting is influenced to a major extent by surface roughness, the first step taken to solve the problem was honing, but this approach only met with limited success. The problem of micro-

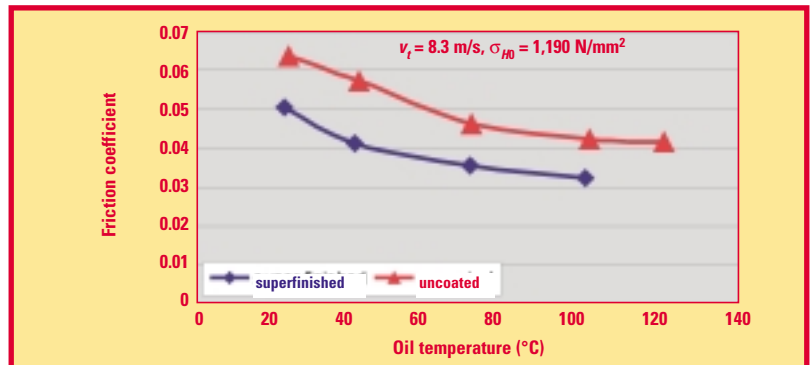

Figure 17—Measured coefficient of friction for mineral oil.

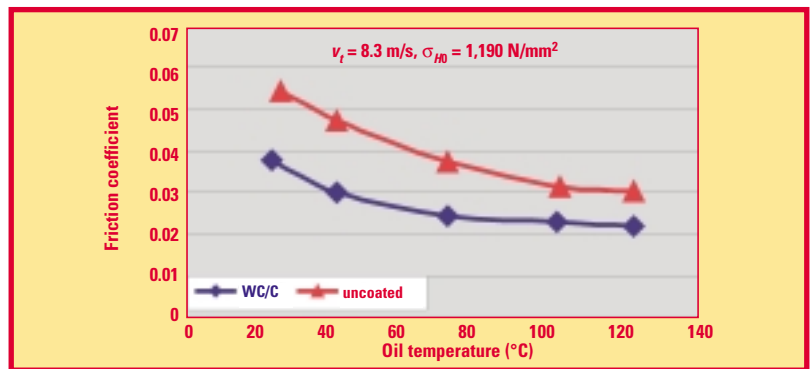

Figure 18—Measured coefficient of friction for synthetic oil.

Application/Transmission	Problem	Coated Parts	Result
Concrete mixer	Wear	Sun gear	+
Automatic bus transmission (race truck)	Macropitting	Sun gear	+
Flap actuator	Wear	Internal gear	+
Truck transmission (planetary gear set)	Fretting corrosion	Sun gear	—
Automatic car transmission	Macropitting	Sun & planet gears	—
Manual car transmission	Macropitting	Pinion shaft	—
Tractor transmission	Micropitting	Pinion	+

pitting was not resolved until a coating was applied.

In overall terms, it has been established that coating offers great potential for optimizing components. Having said that, this is highly dependent on the application in question and on the influencing parameters, not all of which are fully understood at this time. There is therefore no option to performing a separate test for each application.

It is also still uncertain how layers behave in response to interactions between the lubricant and its additives. Here the question of mutual impact of lubricant and coating arises. For example, there are lubricants where certain types of coatings do not work. Why is that so?

The failure of boundary layer formation processes to occur may have a key role to play in this.

Lubricants usually react when in contact with a friction partner's surfaces and there, they are creating boundary layers (barrier layers). So the question arises whether these boundary layers are also created when the surfaces are coated?

Going a step further, are these boundary layers still required in case of coatings? Or even worse, may they have a detrimental impact?

Tests were not run for this interference, though, so this discussion is speculative.

Conclusion

PVD coating and superfinishing can sometimes provide significant increases in scuffing resistance, wear resistance, macropitting resistance, and micropitting resistance. Furthermore, the coefficient of friction can be reduced. However, results of transmission tests with different transmissions and applications vary. The reasons are not clearly understood. Maybe coatings and surface improvements are sensitive to edge loading, inadequate tip relief, the wrong type of lubricant, or other factors. So far, surface improvements have mostly been used as problem solvers. In the future, they will become construction elements of surface engineering. Further influences and properties have to be investigated, such as endurance limits, surface roughness, structure, pre-treatment, influence of lubricant, coefficient of friction, efficiency, adherence, and quality control. ⚙️

This paper was presented at the International Conference on Gears, held March 13–15, 2002, in Munich, Germany. It has been twice published by VDI. The first publication was in VDI report 1665, the conference's proceedings, via VDI Verlag GmbH. The second publication was in the March 2004 issue of Konstruktion magazine, which is published through Springer VDI Verlag. The paper is republished here with VDI's permission.

References

1. Joachim, F. J. "Influence of Coatings on the Durability of Case-Hardened Gears," 2nd Balzers Technical Forum, Bingen, Germany, Oct. 16–17, 2000.
2. Glatthaar, B., F. J. Joachim and N. Kurz. "Langsamlaufverschleiß in Leistungsgetrieben," *Tribology 2000-Plus, Technische Akademie Esslingen*, 12th International Colloquium, Esslingen, Germany, Jan. 11–13, 2000, pp. 585–591.
3. Kleff, J. and D. Wiedmann. "Neue Wege bei der Wärmebehandlung und Oberflächenbehandlung hochbelasteter Luftfahrt-Getriebebauteile," *Härterei-Technische Mitteilungen*, Vol. 55, No. 1, 2000, Carl Hanser Verlag, München, Germany, pp. 59–64.
4. Michler, Th. and M. Laakmann. "Verbesserung der tribotechnischen Eigenschaften von Verzahnungen durch WC/C-Schichten," *Antriebstechnik*, Vol. 99, No. 6, 1999, pp. 67–70.
5. Stott, W. "Myths and Miracles of Gear Coatings," *Gear Technology*, Vol. 16, No. 4, July/Aug. 1999, pp. 35–44.
6. Michaud, M., G. Sroka, and L. Winkelmann. "Chemically Accelerated Vibratory Finishing for the Elimination of Wear and Pitting of Alloy Steel Gears," *News Digest*, Vol. 60, No. 1, Winter 2003, pp. 21–37.

Tell Us What You Think . . .

E-mail wrs@geartechnology.com to

- Rate this article
- Request more information
- Contact the authors or organizations mentioned
- Make a suggestion

Or call (847) 437-6604 to talk to one of our editors!

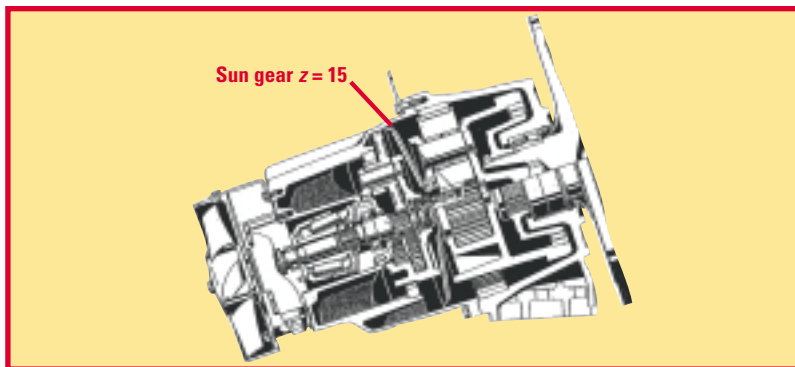

Figure 19—Concrete mixer transmission with WC/C-coated sun gear.

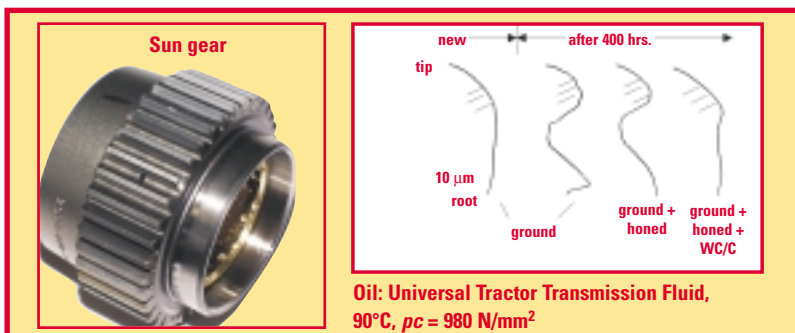

Figure 20—Influence of honing and coating on micropitting.