

gear

TECHNOLOGY®

JUL
2020

FORGINGS & GEAR BLANKS

SKIVING
AUTOMOTIVE



Advanced technology for highly efficient production of external and internal gears.



Solutions for all your gear cutting tool needs

Gear cutting tools and services

Star SU offers a wide variety of gear cutting tools and services, including:

- Gear hobs
- Chamfer hobs
- Milling cutters
- Shaper cutters
- Scudding® and Power Skiving cutters
- Shaving cutters
- Chamfer and deburring tools
- Rack and saw cutters

- Master gears
- Ring and plug gauges
- Advanced coatings including ALTENSA and ALCRONA PRO
- Tool re-sharpening

Total tool life cycle management

Control your tool costs and let Star SU manage your tool room. From new tools to design work to re-sharpening and recoating, we have the equipment and resources to help keep your gear cutting operation running smoothly.



SAMPUTENSILI



Phone: 847-649-1450

5200 Prairie Stone Pkwy. | Ste. 100 | Hoffman Estates | IL 60192



Economical hob sharpening and in-house tool maintenance

The Star NXT linear CNC tool and cutter grinding machine sharpens both straight and spiral gash hob designs up to 8" OD x 10" OAL. With a small footprint and maximized grind zone, the NXT also sharpens disk, shank and helical type shaper cutters, Scudding® cutters, and a wide range of round tools, making it a versatile tool room machine.

SICMAT

Profilator



www.star-su.com



A Publication of
The American Gear
Manufacturers Association



22

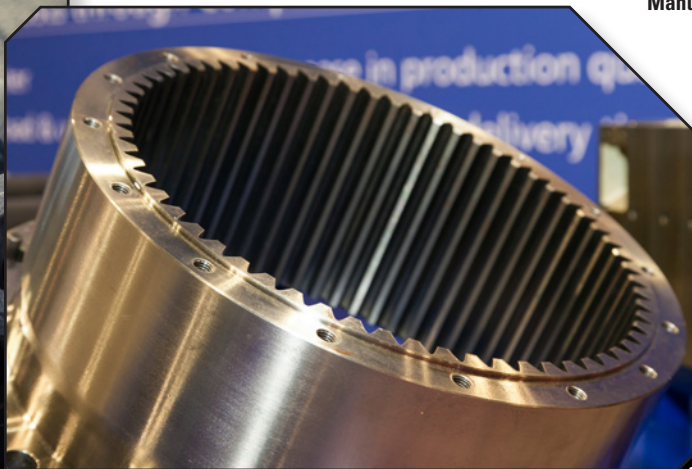

18

features

- 18 The Perfect Time for Power Skiving**
Power skiving gives company strong competitive edge as industries gear up for the post-pandemic
- 22 Supply Chain Management Users Guide**
Gear blank and forging suppliers give insight to gear manufacturers' supply chain challenges during the global crisis.

technical

- 34 DIN Q6 Meets DIN Q10 – the Need for Modern Internal Gear Production**
Transmission engineers strive to lower NVH levels, but increase of quality drives up costs; this "trilemma" must be broken by compromise between structure-borne noise, airborne noise and costs.
- 40 High Traction Differentials**
How a ratio change can improve traction.
- 46 Influence of Planet Carrier Misalignments on the Operational Behavior of Planetary Gearboxes**
A report on further improvement of validity of today' simulation models via first large-scale validation by means of a wind turbine.

The leading manufacturer
of skiving machines.



PITTLER
SKIVING

- Turning, milling, drilling, gear cutting, deburring and more in one machine
- Stable gear cutting with PITTLER Skiving technology
- Clamping and skiving tools from a single source
- Ideal for ring gear and step pinion machining

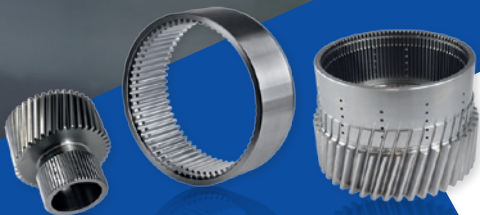

Curious to learn more?
CONTACT US:

DVS Technology America Inc.

☎ 734-656-2080

✉ sales.america@dvs-technology.com

www.pittler.de

PITTLER SkiveLine

Worldwide the only gear cutter with
integrated complete machining

www.dvs-technology.com

DVS
TECHNOLOGY
GROUP

Spiral Bevel Gears

- Spiral & straight bevel gear manufacturing.
- Commercial to aircraft quality gearing.
- Spur, helical, splined shafts, internal & external, shaved & ground gears.
- Spiral bevel grinding.
- Midwest Transmissions & Reducers.
- ISO compliant.



Midwest Gear & Tool, Inc.
15700 Common Rd., Roseville, MI 48066
Tel: 586.779.1300 mwgear@midwestgear.net

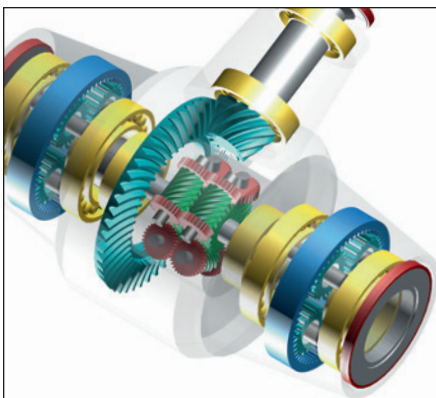

NEW
Release
2020

KISSsoft Highlights

- Rainflow method for load data analysis
- Reliability evaluation with AGMA 6006, VDMA 23904 and Bertsche
- Revised tooth root and flank rating according to ISO 6336:2019
- Scripting language for automation and extension of calculations
- Gearbox data exchange with REXS

KISSsoft AG/Gleason Sales
Brian P. Stringer
Phone (585) 494-2470
info@KISSsoft.com

Free trial version at www.KISSsoft.com

Drivetrain Design Solutions **KISSsoft**

gear TECHNOLOGY®

Vol. 37, No. 5

departments

- 06 GT Extras**
GT Videos: WFL presents latest gearing technologies; **Gleason** introduces hard finishing cell. **Editor's Choice: Emuge** offers efficient, quick-change workholding; **Gear Talk** with **Charles Schultz**—Learn the importance of training and education during slow economic periods.
- 09 Publisher's Page**
Thanks, Team!
- 12 Product News**
Solar Atmospheres installs gas nitriding furnace; **CAS DataLoggers** offers vibration measurement system; **Helios Gear** introduces Hera 500 gear hobbing
- 56 Industry News**
News and notes from **Machine Tool Builders**, **Global Gear**, **EMAG**, **Bourn & Koch** and more.
- 62 Advertiser Index**
Contact information for companies in this issue.
- 63 Subscriptions**
Fill out the form to continue receiving *Gear Technology*.
- 64 Addendum**
Rudolf Diesel—Man of Motion and Mystery.





WGT Gear Measuring Machines



- Highest accuracy is guaranteed by using granite guides, air bearings, precision rotary table and Renishaw scanning probe
- Low cost of ownership and high uptime
- User friendly software packages for various types of gears, gear cutting tools and shaft geometry
- Ergonomic design
- Manufacturer neutral GDE interface for data transmission to production machines

**THE GEAR INDUSTRY'S
INFORMATION SOURCE**

www.geartechnology.com

WFL Presents Latest Gearing Technologies

High quality standards, profile accuracy and machining solutions that offer both reliability and flexibility are features that are critical when manufacturing gears. Read the full WFL MillTurn story here:

www.geartechnology.com/videos/WFL-Presents-Latest-Gearing-Technologies



Gleason Introduces Hard Finishing Cell

The Gleason HFC features a fully-automated, Closed Loop manufacturing system for gears with in-process gear inspection, real-time analysis and automatic feedback of corrections to the hard finishing production machine. Additionally, the HFC can integrate a wealth of auxiliary options.

www.geartechnology.com/videos/Gleason-Hard-Finishing-Cell/

Editor's Choice:

Emuge Offers Efficient, Quick-Change Workholding

Controlling production costs is critical for today's gear manufacturers, especially when factoring in global economic pressures. One key effective cost savings measure is using a quality quick-change workholding system (QCS). Learn more here:



www.geartechnology.com/blog/emuge-offers-efficient-quick-change-workholding/

Gear Talk with Charles Schultz

Learn the importance of training and education during slow economic periods in the gear industry here: www.geartechnology.com/blog/how-do-we-fix-this/

Stay Connected



Join the Gear Technology Facebook group at www.facebook.com/groups/210890932629794/

Follow us on Twitter twitter.com/#!/Gear_Technology



Connect with us on LinkedIn www.linkedin.com/groups/3893880/

Subscribe Online www.geartechnology.com/subscribe.htm



**gear
TECHNOLOGY®**



AGMA MEDIA
1840 JARVIS AVENUE
ELK GROVE VILLAGE, IL 60007
(847) 437-6604
FAX: (847) 437-6618

EDITORIAL

Publisher & Editor-in-Chief

Randy Stott, Vice President Media
stott@agma.org

Senior Editor

Jack McGuinn
mcguinn@agma.org

Senior Editor

Matthew Jaster
jaster@agma.org

Technical Editors

William (Bill) Bradley, Robert Errichello, John Lange, Joseph Mihelick, Charles D. Schultz, P.E., Robert E. Smith, Mike Tennutti, Frank Uherek

DESIGN

Art Director

David Ropinski
ropinski@agma.org

ADVERTISING

Associate Publisher & Advertising Sales Manager

Dave Friedman
friedman@agma.org

Materials Coordinator

Dorothy Fiandaca
fiandaca@agma.org

China Sales Agent

Eric Wu, Eastco Industry Co., Ltd.
Tel: (86)(21) 52305107
Fax: (86)(21) 52305106
Cell: (86) 13817160576
eric.wu@eastcotec.com

CIRCULATION

Circulation Manager

Carol Tratar
tratar@agma.org

MANAGEMENT

President

Matthew E. Croson
croson@agma.org

ACCOUNTING

Accounting

Luann Harrold
harrold@agma.org

FOUNDER

Michael Goldstein founded Gear Technology in 1984 and served as Publisher and Editor-in-Chief from 1984 through 2019. Thanks to his efforts, the Michael Goldstein Gear Technology Library, the largest collection of gear knowledge available anywhere, will remain a free and open resource for the gear industry. More than 36 years' worth of technical articles can be found online at www.geartechnology.com. Michael continues working with the magazine in a consulting role and can be reached via e-mail at michael@geartechnology.com.

SHAPE UP

Reman Your

Fellows

10-4 GEAR SHAPERS



Photos show before and after remanufactured Fellows Shapers



BUILT FOR TODAY'S RIGOROUS GEAR MANUFACTURING.

- Electronic Helical Guide Option
- Fanuc Controls
- Up to 6-Axis CNC Available
- Automotive and Aerospace Applications
- 12-Month Machine Warranty
- Stock Machines Available

MSS300

SuperSkiving



The Mitsubishi
MSS300 Super
Skiving Machine:
**Cutting Into
The Competition**

Designed for
Internal Gears

Ultra Rigid
Machine Base

Up to **5x More**
Production

Precision Machine
Designed for
Productivity & Quality

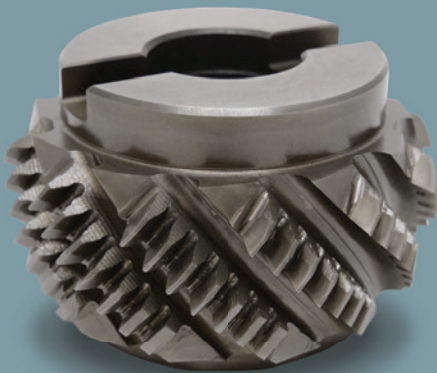

Reimagined Super Skiving Technology Makes Flexible, High-Volume Internal Gear Manufacturing Within Reach.

The all new MSS300 brings flexible, high-volume internal gear skiving to internal gear manufacturing. With revolutionary Multi-Blade skiving tools, it produces three to five times more parts than conventional tools. Additionally, the MSS300 offers greater flexibility by cutting restrictive geometries and even allowing parts previously manufactured in two parts to be cut in one Super Skiving process. To learn more about how the MSS300 is ready cut up your competition visit www.mitsubishigearcenter.com or contact sales at 248-669-6136.

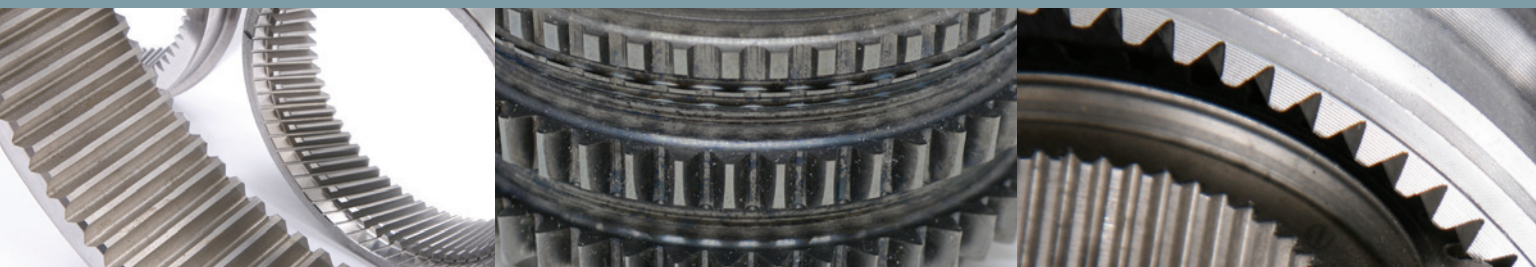

Thanks, Team!



Publisher & Editor-in-Chief
Randy Stott

It takes a lot to put together a magazine like this one, issue after issue.

There are articles to edit, materials to gather, production to coordinate, layouts to develop, subscriptions to enter and much, much more. The process for any individual issue begins as much as a year in advance, when we start to talk about the topics we'll cover, sell the advertising that will be included, identify likely technical papers that will serve our audience.

All of that is especially hard when authors, advertisers, contributors and colleagues are all working from home, working intermittently, on temporary leave or furloughed. Everyone is much harder to get a hold of, and even the simplest communications can become challenging.

Here at AGMA Media, we've weathered those challenges extremely well. Although our staff has been mostly working from home, they continue to hit their deadlines, produce quality work and turn out the magazine that all of you have come to expect.

That staff deserves a little recognition.

You're probably used to seeing my name, and our other editors', in the pages of the magazine. But there are quite a few others without whose contributions none of this would be possible.

Each member of our staff has been with *Gear Technology* for many years. In fact, their average tenure here is 17 years, making our team more like friends and family than colleagues and coworkers. These people have been serving the gear industry for a long, long time. Their combined dedication and professionalism are what help make *Gear Technology* the voice of the industry, and their work is delivered to your desk or e-mail inbox every issue.

Much of that work is done behind the scenes, so most of you don't often have the opportunity to interact with them. But what they do is critical to our success, and recognizing them is long overdue.

So thank you, Dorothy Fiandaca.

Thank you, Dave Friedman.

Thank you, Luann Harrold.

Thank you, Matt Jaster

Thank you, Jack McGuinn.

Thank you, Dave Ropinski.

Thank you, Carol Tratar.

I appreciate your efforts over the past many years, but especially throughout 2020 as we've all had to adjust to strange new ways of working. This magazine – with its quality technical articles, well-written features, timely news and relevant product information – is a testament to the significance of your hard work.

It's been a crazy, tough year, and it's taken a crazy-tough team to get through it as well as we have. There's no telling what the future will hold, but I'm confident that no matter what challenges come our way, this team will continue to produce the best possible magazine for the gear industry.

So thanks, team, for everything you do. I appreciate your efforts, and I'm sure our readers do, too.

Hoffmann Group

TESTS AND OPTIMIZES TOOLING WITH WFL MILLTURN MACHINING CENTER

With over 4,000 employees and an extensive range of tools, operating equipment and personal protective equipment, the Hoffmann Group is one of the major players in the industry. In 2019, its parent company, Hoffmann SE, celebrated its 100th anniversary. The first WFL Millturn complete machining center was also commissioned last year at the Hoffmann Group. This machine takes on a highly unconventional role – rather than producing components, it is used to test and optimize tools. These are ruthlessly pushed to their very limits. The result is a huge amount of chips and valuable tool data.

We don't make tools in this department, they are developed in conjunction with suppliers," explains Dr. Jens Rossaint, director of engineering, who is responsible for the technology department and therefore the quality management of products developed for the catalogue. This is extremely important, as the catalog is key at the Hoffmann Group. The orange 'tool bible' has been published annually since 1978. It is available in 18 languages and now comes in four volumes with a print run of 900,000 copies. In 2000, an online version with over 90,000 items to choose from was also launched with the eShop.

"The process for including a product in the catalog typically goes like this: we define what the tool should be



Having all the tools and equipment in-house proved valuable for the Hoffmann Group.

able to do, draw up a specification, integrate technical ideas. Then there's some kind of tendering process and we narrow down the number of suppliers to a shortlist. These then manufacture prototype tools. This is followed by testing, a comparison with competitor products and benchmarking. The tools are then continuously developed by the supplier. These tools are then only found at Hoffmann in this manner. After testing, the new tools gradually enter the catalogue. We mainly sell standard tools. But we do offer a few special tools too," said Rossaint in regard to their workflows.

The Technology Center in Munich,

opened in September 2019, has been equipped with extensive measurement and testing equipment as well as numerous demonstration and training facilities. In addition to the measuring room which features a coordinate measuring machine, all conceivable analytical equipment, from a hardness tester to a scanning electron microscope, is available for scientifically examining the properties of the tool's structure. Ultimately, the question is why might a tool be good or bad? The structure allows conclusions to be drawn about the performance and durability of a tool. "We're not interested in blind trial and error, instead we want to take a targeted approach to development and optimization," explains Rossaint. Alongside laboratory equipment, the Munich Technology Center also features operating equipment from the catalogue, which clearly demonstrates the optimum way to set up the machine environment.

Programming is carried out with a CAM programming system. Easier programming jobs are completed directly on the control unit using Millturn PRO, a proprietary WFL programming editor. "We also like to use this for specific tasks," said Thomas Grünberger, an expert in machining and additive manufacturing. "We want to make really great

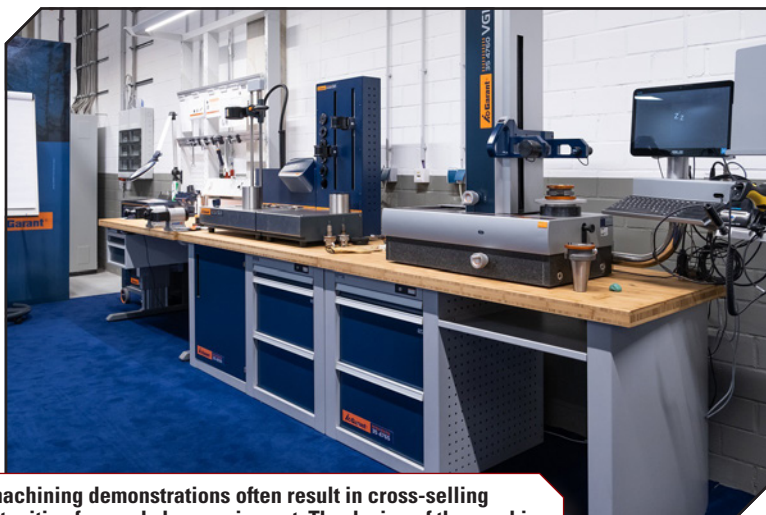

The machining demonstrations often result in cross-selling opportunities for workshop equipment. The design of the machine environment has a decisive effect on production efficiency.

show parts with it. With the tool turret and turning-boring-milling unit also in use at the same time, of course. And we also have the driven tools on the tool turret. We want to push the machine to its limits.”

If tolerances are very tight, a Renishaw in-process measuring probe is also used. A whole range of WFL measuring cycles are available for this.

The Hoffmann Group needed to be able to test as many different tools and technologies as possible. It was also important that newly developed tools could be represented in the machine. Another requirement was that the company’s own software developments – particularly for tool management – could be integrated into the machine and that they could build upon existing software solutions for future developments. Willingness to work together with the machine manufacturer is essential here.

“It’s a huge advantage to also be able to test large inserts without immediately bringing the machine to its knees. The highly flexible clamping options mean that we can also use larger diameters with ease, to extend the test ever further, obtain even more data and carry it out for a suitable length of time with a high level of machining performance. Ultimately, it gives us the means to test tools more efficiently. With the WFL, we can now perfectly test HSK-63 turning tools and thereby optimize our product portfolio. The B-axis is also a huge plus during turning, as we have great flexibility for adjusting the entering angle. When our field sales staff come back with various customer requests, we can reproduce practically any situation, from VDI40 on the tool turret to any tool in the turning-boring-milling unit at any possible angle. The milling spindle was designed for 16,000 rpm, so we are also well equipped for future requirements,” said Rossaint.

For more information:
Hoffmann Group
Phone: (844) 448-7725
www.hoffmann-group.com

WFL Millturn Technologies, Inc.
Phone: (248) 347-9390
www.wfl.at

NUM

SOFTWARE PROVIDES ‘OFF THE SHELF’ SOLUTION FOR NON-CIRCULAR GRINDING

NUM provides manufacturers of CNC cylindrical grinding machines with an elegant means of adding non-circular grinding capabilities to their products – without incurring significant development time and cost. Non-circular grinding is used in a wide variety of automated manufacturing applications,

such as the production of camshafts, crankshafts, cams and eccentric shafts. However, it is an extremely complex task, because the non-circular contour leads to constantly changing engagement and movement conditions between the grinding wheel and the workpiece.

NUM has now added non-circular

Gearing your past to power your future.

Breakdown Services
We understand the urgency of meeting critical deadlines. We offer our customers expedited services without sacrificing quality.

Heat Treatment
Our in-house heat treat facility performs a full range of services that include annealing, carburizing, and thru hardening.

B&R
MACHINE AND GEAR CORP.

B&R Machine and Gear Corporation is a full service gear manufacturing facility driven to power your equipment with reliable and durable gears that are built to perform and last. Find the perfect mesh. No matter the gear, we've got you covered.

VISIT OUR WEBSITE BRGEAR.COM FOR MORE INFORMATION

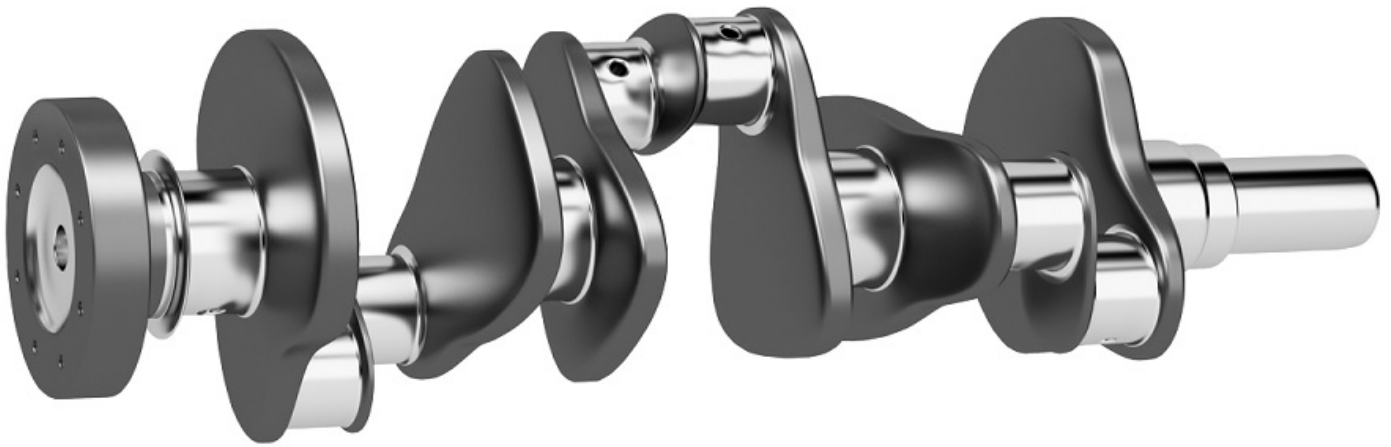

grinding functionality to its *NUMgrind* cylindrical grinding software, which forms an application-specific element of the company's renowned Flexium+ CNC platform. It is fully compatible with other *Flexium* software, from release 4.1.20.00 onwards.

NUMgrind is specifically designed to simplify the creation of G code programs for CNC grinding machines through the use of a highly intuitive graphical human machine interface (HMI), conversational-style 'fill in the blanks' type dialogues or a combination of the two.

Unlike conventional CAD/CAM workstation tools for generating CNC machine tool control programs, *NUMgrind* is intended for use in the production environment. It enables shop floor personnel to handle everyday machining tasks very quickly and efficiently – and the work can be easily shared amongst several people and several machines.

The *NUMgrind* HMI can of course also be run on an office PC. Application-dependent projects, and the corresponding ISO part programs, can be created,

tested with NUM's *Flexium 3D* simulation software and transferred to the targeted machine.

The operator simply determines the sequence of the grinding process via the HMI and enters the necessary data for the grinding operations, grinding wheels and dressing operations in the dialogue pages. Programming is further simplified by the fact that the HMI is supported by a comprehensive library of predefined shapes, which includes eccentric circles, hexagons, pentagons, polygons, Reuleaux triangles and rhombi. The CNC program is then created completely automatically and stored in an executable form.

The closed shape of the workpiece is defined in the XY plane. However, grinding is performed by interpolating or synchronizing the X axis with the C axis (workpiece spindle). Axial movement in the Z axis can also be accommodated, by means of oscillation or 'multi-plunge.' The *Flexium+* CNC system's NCK transforms the contour from the XY plane into an XC plane, and calculates the corresponding compensation and in-feed movements, taking the grinding wheel diameter into account. The speed profile is also transformed, so that the speed and acceleration are automatically adapted to suit the physical attributes of the machine.

For more information:

NUM
Phone: (630) 505-7722
www.num.com

60 Years Proven

ROBOTICS • AEROSPACE • DEFENSE • TRANSPORTATION • MEDICAL

When machine failure is not an option,
they call on Spiroid.



Spiroid's skew-axis, high torque gears enable world-class power density in a small footprint.

Visit online to learn more. SpiroidGearing.com

Superior Abrasives

OFFERS SURFACE CONDITIONING BELTS

Superior Abrasives, LLC introduces Shur-Brite Surface Conditioning Belts which feature an open structure to resist overheating, part discoloration, or loading, to ensure consistent quality over the belt life, making it ideal for treating large surface areas. With repeatable finishes, Shur-Brite belts are ideal for large scale robotic applications. Users can create linear scratch patterns on stainless steel food equipment, and blend or re-orient scratch patterns after repairs. High edge durability and flexibility without chunking, and smear-free removal of oxidation, paint or adhesives make them ideal for many manufacturing and re-manufacturing environments. Ideal for a wide variety of materials including ferrous and non-ferrous metals, stainless steel, exotic alloys, plastics, and composites.

In narrow or short form, like file belts, the surface conditioning material is manufactured with additional flex, easily conforming to small contact wheels and narrow areas of the workpiece. They are ideal for air-file belt sanders, portable belt sanders, and benchstand belt sanders. Wide belts utilize a low stretch reinforcement, providing stability and reduced changeover on large, robotic equipment. Reduced stretching and high edge retention ensures durability and consistent performance throughout use. They generate lower heat which provides longer service life. A variety of Shur-Kut Coated Belt materials are also available for more aggressive removal, shaping or finishing of handheld or stationary workpieces.

For more information:

Superior Abrasives, LLC
Phone: (800) 235-9123
www.superiorabrasives.com



RINGS | **DISCS**
4"-144" OD | UP TO 60"

EASY DOES IT

Service. Quality. Speed.

McInnes Rolled Rings believes in providing superior service and outstanding quality products, ensuring the entire sales process is as easy and as fast as possible for our customers.

When it's seamless, it's McInnes.

McINNES
ROLLED RINGS

1.877.695.0280 • www.McInnesRolledRings.com/Easy

GWJ Technology

OFFERS DETAILED ONLINE CALCULATION OF PLASTIC GEARS

GWJ Technology has updated its web-based calculation software *eAssistant*. The calculation of plastic gears is now available.

In addition to the common calculation methods for the load capacity DIN 3990, ISO 6336 and ANSI/AGMA 2101, the calculation method VDI 2736 for plastic gears was added to the cylindrical gear module. The first plastic materials were added to the general material database. For this, the temperature-dependent material properties such as fatigue strength and E-module were approximated in detail from available diagrams in VDI 2736 and stored accordingly. These are used to determine the material properties for the calculation of the load capacity using the tooth root and flank temperatures automatically calculated according to VDI 2736.

If the calculated tooth flank and tooth root temperatures exceed the maximum operating temperatures of

the plastics, a corresponding warning is given.

In order to calculate the tooth flank and tooth root temperature, the user can modify the housing design, the heat-dissipating surface as well as the heat transfer and heat resistance as an alternative to the automatic default settings.

Pairings of plastic/plastic as well as plastic/metal are supported. Furthermore, metal/metal pairings are also available in order to compare calculation methods for metallic gears. The calculation of load spectra is also possible for the load capacity calculation according to VDI 2736. In addition, "Dry run" was added to the lubrication types for VDI 2736.

For more information:

GWJ Technology
Phone: +49 (0) 531 129 399-0
www.gwj.de

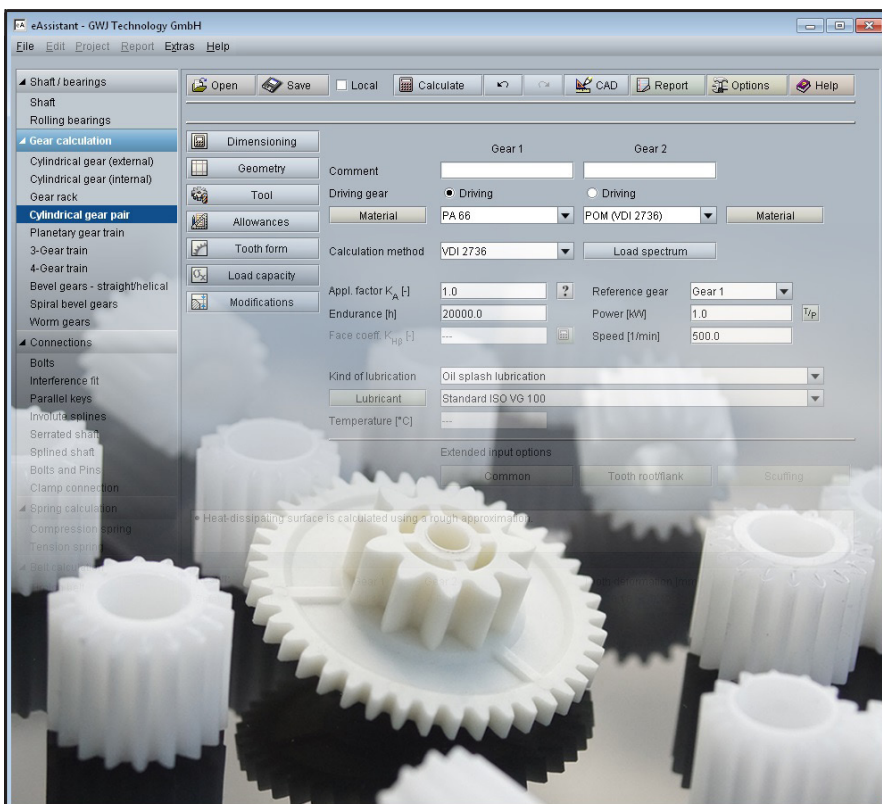

Helios Gear

INTRODUCES HERA 500 GEAR HOBBING MACHINE

Helios Gear Products announces the Helios Hera 500 CNC gear hobbing machine for the North American market. This machine, built by YG Tech, offers gear manufacturers a versatile vertical gear cutting solution for medium to large parts. David Harroun, vice president of Helios said, "The Hera 500 suits job shops, gearbox repair shops, and gearing for the construction, energy, and off-highway industries due to the wide range of part sizes and types that manufacturers can produce on the machine."

The Hera 500 uses advanced technology such as FANUC 0i MF CNC, servomotors, direct-drive work spindle, X-axis linear scale for accurate repeatable control of size, automatic retract of X-axis at power failure, and more. The machine offers safety features such as electro-mechanical interlock and a splashguard door. Also, the machine's cast iron base provides superior dampening and stability for extreme cutting conditions. With an affordable price, proven domestic support from Helios, and a unique mix of technical capabilities and optional features, the Hera 500 equips manufacturers to make profitable gears for the global market.

Standard features of the Hera 500 include 6 CNC axes (7 with automation), a 12 module (2.11 DP) pitch rating, and rigid construction for the most demanding jobs. Additionally, this machine has a radial travel of 360 mm (14.173 in) from 40 mm (1.574 in) to 400 mm (17.748 in) center distance between the work and hob axes, which accommodates a wide range of part sizes. The Hera 500 also uses long hobs, up to 260 mm (10.236 in) long with shifting up to 240 mm (9.448 in). The machine has a maximum tailstock position of 820 mm





(32.283 in) and a maximum axial travel of 380 mm (14.960 in), so manufacturers can also cut a wide range of part lengths. Thus, this hobbing platform offers a universal solution for gear manufacturers.

Operators enjoy the machine's easy-to-use dialog programming with visual examples that guide and accelerate training. Programming includes cutting one or two gears on a single workpiece using single- or two-cut cycles with radial, axial, climb, or conventional hobbing (or any combination thereof). Additionally, crowning (lead modification) and automatic shifting over a damaged hob section are included in the base package.

The YG Tech Co., Ltd., has constructed gear cutting machine tools since 1963, and the Hera series started in 2004, having grown to hundreds of installations around the world. Helios Gear Products brings 30+ years of experience in machines, tools, engineering, and technical support. Together, the two companies supply the Hera line of hobbing machines in North America with a proven combination of technical and engineering support.

For more information:
 Helios Gear Products
 Phone: (847) 931-4121
www.heliosgearproducts.com

CAS DataLoggers

OFFERS VIBRATION MEASUREMENT SYSTEM

The Delphin vibration measurement system is highly accurate because it captures vibration frequencies, phase changes and amplitudes before analysis is performed. The Expert Vibro records time domain data and also calculates Fast Fourier Transform (FFT) spectral analysis for frequency domain results. The Expert Vibro can even control the

shaker through analog or digital outputs by triggering shut-off procedures, delivering email notifications, or performing other tasks if an alarm event occurs outside of the set points assigned by the user. Meanwhile configuration and measurement data are shown on the touch-screen display for added convenience.

The Delphin Expert Vibro solution

NACHI

Redefining the Science of Cutting Technology

*Best Delivery in the Industry
for Skiving and Shaper Cutters*



*REVOlutionizing
Drilling*



*Leading the World in
Hard Broaching Technology*



Gear & Round Cutting Tool Divisions
 Visit Our Production Facilities ~
 717 Pushville Rd., Greenwood, IN 46143

317-530-1004 - Gear Tools 317-530-1003 - Round Cutting Tools
www.nachiamerica.com

represents a leap in technology because it provides users with high speed data acquisition, intelligent signal processing, analysis functions, local data storage and versatile communication options in a single device. With continuous sampling even the smallest of irregularities can be recorded to the internal 32 GB data storage capability, making it especially reliable and secure.

Using the latest dual-core FPGA processor technology for extensive computations and analysis, the compact Expert Vibro supports high sampling rates of up to 50kHz per channel while the 24-Bit A/D converter ensures high-precision measurement. All channels have galvanic isolation to prevent transverse distortions and the analog inputs can accept voltage or current inputs, direct IEPE sensors or digital rotation sensors with full configuration ability present in the ProfiSignal software.

As part of its research and development, a manufacturer of cooling and refrigeration equipment is using an Expert Vibro system for shaker test stand measurements. Users acquire data from multiple synchronous accelerometer sensors and evaluate them using the ProfiSignal software. ProfiSignal is a



complete software system for data acquisition, analysis, visualization and automation. The software is user-friendly and combines professional functionality with easy operation.

After data is measured and recorded, the optional ProfiSignal Vibro module provides evaluation of the recorded and real-time data using FFTs, cascade, time signal and orbit diagrams.

Expert Vibro data loggers can be connected to PCs via LAN or USB or various serial standards and Modbus TCP/IP and ProfiBus can connect to PLC

systems. For large applications multiple Expert devices can be synchronized to process vibration data from many channels.

Optional integrated Wi-Fi, GSM, UMTS or LTE modules are available to extend the communication options for remote condition monitoring applications of operating rotating equipment.

For more information:

CAS DataLoggers
Phone: (800) 956-4437
www.dataloggerinc.com

SMW Autoblok

OFFERS SELF-CENTERING POWER CHUCK

SMW Autoblok recently introduced the SJL 6-jaw (2+2+2) equalizing and self-centering power chuck.

Ideal for CNC machining applications, the SJL provides the highest accuracy for thin-walled and deformation-sensitive



workpieces. Unique to the SJL is the ability to be switched from a 2+2+2 lever equalizing chuck to classic 6-jaw self-centering chuck depending on application requirements.

Utilizing the 2+2+2 lever balance capability provides high concentricity and axial runout accuracies by ensuring that the grip force of each jaw set equalize as pairs and are in contact with the workpiece continuously. This minimizes any deformations or inaccuracies of raw materials.

The 6-jaw self-centering option provides a concentric clamp locking plate for all sequential six jaws allowing the chuck to hold round, machined diameters and thin-walled workpieces that require equal wall thicknesses.

Specifically designed with centrifugal force compensation, this feature provides constant gripping force at higher speeds and feeds, vastly reducing production time. The SJL is Proofline sealed and interior protected from contamination while providing consistent lubrication allowing for long maintenance intervals. This advanced power chuck accepts either tongue and groove or metric serrated top jaws and is available in sizes from 225-400 mm.

For more information:

SMW Autoblok
Phone: (847) 215-0591
www.smwautoblok.com

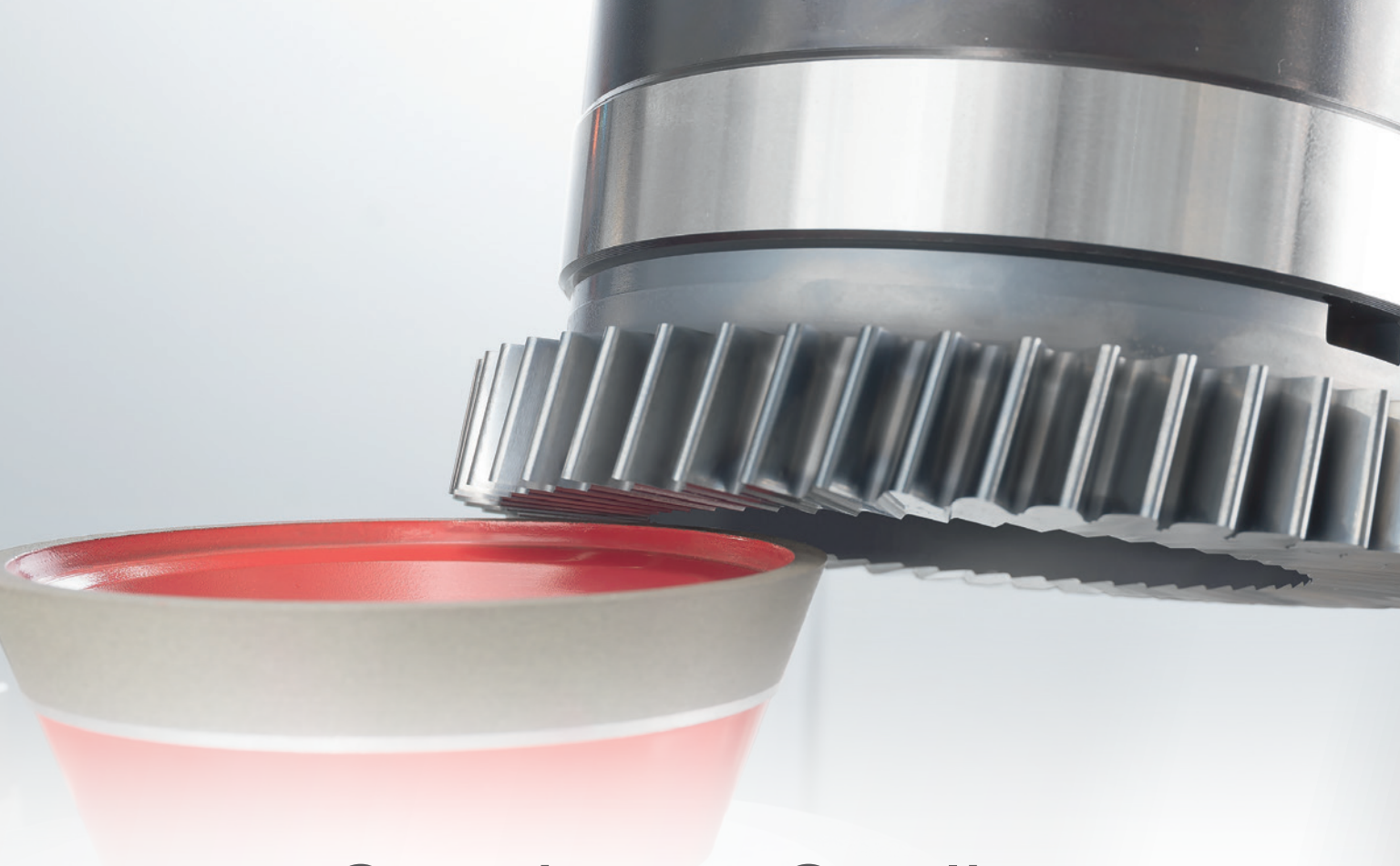

Consistent Quality with Reduced Cost

Resharpener of cutters for both soft cutting and fine finishing can now be fully automated on Gleason vertical Power Skiving machines, greatly reducing tool cost-per-piece and helping ensure consistently high quality.

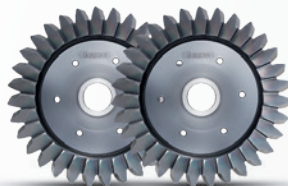

See it
in Action



Total Gear Solutions **Gleason**

The Perfect Time for Power Skiving

Italian gear manufacturer Metalcastello's investment in new Gleason Power Skiving technology gives the company a strong competitive edge as the world's industries gear up for the post-pandemic.

Giulio Santantonio, Sales Manager, Gleason Sales (Italy)

For a global industrial powerhouse like CIE Automotive, challenging times also mean new opportunity. With its recent acquisition of Somaschini, CIE Automotive's gear production combines Somaschini's two gear production plants in Italy and one in Indiana with Metalcastello S.p.a. in Bologna, Italy and a gear division based in India. Automotive, industrial vehicle, agricultural, and off-road vehicle manufacturers all stand to benefit from the global reach and synergies that will result — and the new technologies that Metalcastello in particular can offer.

A Perfect Time for Power Skiving

Metalcastello is a highly respected manufacturer of heavy-duty transmission gears and shafts used in earth-moving machines, tractors, and industrial vehicles operating on every continent. The company's investment in three new Gleason 600PS Power Skiving Machines has given it capacity to spare for the production of critically important internal ring gears, some as large as 550 mm in diameter, used in the planetary gear systems of many of these transmissions — while simultaneously improving quality from DIN 9 to DIN 7.



There was nothing wrong with the traditional shaping process or the Gleason shaping machines that the company previously used to produce these gears — unless of course you want to machine at speeds four to five times faster. When Gleason demonstrated that the Power Skiving process for this application could achieve remarkable gains in productivity and quality, Metalcastello saw the potential.

Seeing is believing, and Metalcastello managers came away firm believers in the Gleason Power Skiving process after Gleason conducted trial machining at its facility in Ludwigsburg, Germany. There, a Gleason 600PS was used to machine almost 100 3.5 module, 350 mm diameter, 78-tooth ring gears made of hard 40CrMo4 material — actual customer parts that were being produced on Metalcastello's existing Gleason gear shaping machines. Additionally, the deburring required on the ring gear's lower face — a separate operation typically done off-line — was instead performed during the trial machining by the same cutter used for Power Skiving and thus requiring no additional workpiece changeover time. For this operation, Gleason grinds the backside of the cutter with the required contour of the workpiece to eliminate the burr.

Ultimately, the 100-part demonstration produced some impressive results: the 5.20 minute cycle time for complete machining was some four



ISO 9001
AS9100
ISO 13485
ITAR Certified
WBENC



World-class Gears for ...
Helicopters
Fighting Vehicles
Battle Tanks
Armored Personnel Carriers
Support Vehicles
Unmanned (UAV/UCAV)
Combat Aircraft
Autonomous Vehicles
Military Transport
Amphibious Assault Ships
Submersibles

For Those Who Know **No Limits**

Advanced Materials, Engineered for Extreme Conditions



Excellence Without Exception ... 815.623.2168 ... forestcitygear.com

© 2020 Forest City Gear. All Rights Reserved

to five times faster than shaping, and profile, lead and division quality were measured at a highly desirable DIN 7, two classes better than what was being achieved by shaping. Additionally, it was determined that a cutter made with G70 high speed steel and using an advanced AlCroNite® Pro (AlCrN) coating produced the best results vs. a G50 cutter. Some 50 parts were completed (3,675 m/tooth) with the tool before the end of its useful life and the need for re-sharpening/re-coating.

Today, Metalcastello is reaping the productivity and quality

benefits demonstrated at Gleason with an installation of three Gleason 600PS Power Skiving Machines. While the Gleason shaping machines used previously are still producing parts, Metalcastello now relies heavily on the PS machines to do most if not all of the gears for these important planetary gear systems for transmissions. Cycle time improvements were as demonstrated, and quality levels have been even a class or two better than what was achieved in Ludwigsburg.

Non-productive time is reduced as well with automated workpiece load/unload. The Gleason automation consists of a 2-station ring loader and 12-station revolving magazine. Both are easily adaptable to handle potentially hundreds of different part numbers with minimal changeover.

The Gleason PS system at Metalcastello also includes the Gleason 160CPS Cutter Positioning System, which helps optimize the setting of the Power Skiving cutters, but also can be used to analyze cutter wear through an integrated microscope and PC. It also comes equipped with an RFID reader, which allows for the reading of important data from an RFID chip found in the Gleason Power Skiving cutters.



Planetary gear systems with ring gears as large as 650 mm in diameter are a Metalcastello specialty. Gleason Power Skiving has greatly increased capacity for the production of these important components, also offering the potential for an economical fine finishing capability with Hard Power Skiving.

Finishing with Hard Power Skiving.

While in the past the quality requirements for most, if not all, of these ring gears did not call for a finishing operation after heat treat, Metalcastello is now also using these PS machines to perform Hard Power Skiving—an economical hard finishing alternative to finish grinding. These machines were easily adapted to perform Hard Power Skiving so Metalcastello could begin

No Money for Capital Equipment Purchases? NO PROBLEM!

REPOWER



SIGMA 3

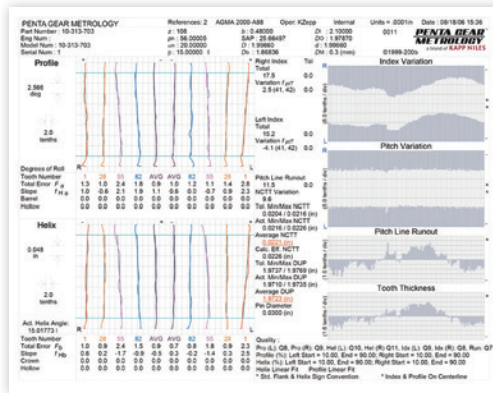

M&M 3025

- REPOWERED BY Penta Gear**
- Analytical Inspection Machine
 - Roll Testers
 - Single Flank
 - DOB Inspection Gauges

PENTA GEAR METROLOGY
a brand of **KAPP NILES**

realizing fine finishing benefits without additional investment in grinding machines. They are inherently extremely rigid platforms and, with the addition of stock dividing sensor and the use of carbide cutting tools designed for the task, can deliver quality and surface finish levels to meet many fine finishing requirements.

Metalcastello is indeed an example of how local Gleason sales support, combined with the Power Skiving process experts in Ludwigsburg, can partner with innovative companies like Metalcastello to successfully achieve the enormous productivity and quality benefits of this exciting technology. The timing, as they say, is perfect. ⚙️

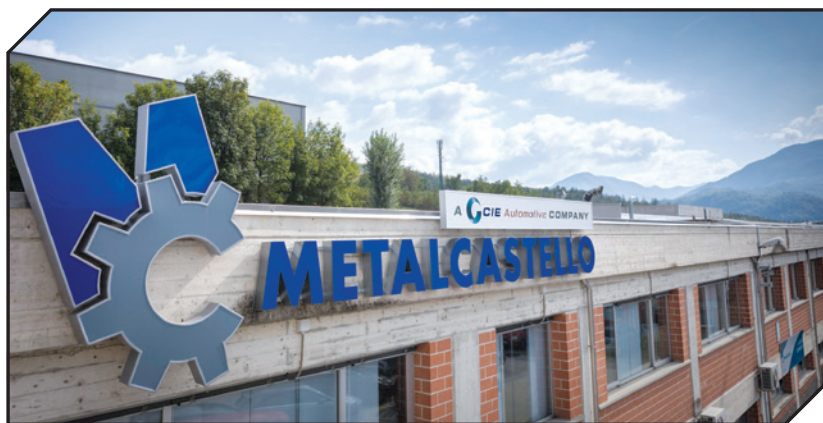

About Metalcastello

Headquartered in Castel di Casio, Italy near Bologna, Metalcastello S.p.a. is a world leader in the production of gears for mechanical transmissions found in earth-moving equipment, farm tractors, industrial vehicles and naval applications.

The company is part of the CIE Automotive Gears Division of CIE Automotive Ltd., a major industrial group among the top 100 suppliers competing globally in the components and assemblies sector. For more information, visit: www.metalcastello.com.

For more information:

Gleason
Phone: (585) 473-1000
www.gleason.com

Giulio Santantonio is Sales Manager, Gleason Sales (Italy)



For Related Articles Search

skiving

at www.geartechnology.com

All The Gear Cutting Tools You Will Ever Need Are Right Here DTR is one of the world's largest producers.

DTR. Your best choice for high quality gear cutting tools.

DTR is a world class supplier of the finest high performance long-life gear manufacturing tools, for small and large gear cutting applications. Established in 1976, we are one of the world's largest producers of cutting tools, shipping to over 20 countries.

DTR offers a full line of gear cutting tools including:

- Hobs
- Carbide Hobs
- Shaper Cutters
- Milling Cutters
- Chamfering and Deburring Tools
- Broaches
- Master Gears

We can produce virtually any tool you need for auto, aerospace, wind, mining, construction and other industrial gears.

Every tool is precision-made utilizing high speed steel, premium powder metal or carbide and the latest in coatings, to achieve superior cutting and long life. DTR uses top of the line equipment including Reischauer CNC grinders and Klingelnberg CNC sharpeners and inspection equipment.

Learn more about our outstanding quality tools at www.dtrtool.com.
Call us at **847-375-8892** for your local sales representative or
Email alex@dtrtool.com for a quotation.



DTR

PERFECTION MOVES US

(formerly Dragon Precision Tools)

WWW.DTRTOOL.COM

DTR has sales territories available. Call for more information.

U.S. Office Location (Chicago) Email inquiries to: alex@dtrtool.com.

1261 Wiley Road, Unit K, Schaumburg, IL 60173

PHONE: 847-375-8892 Fax: 224-220-1311

Headquarters

85, Namdong-daero 370beon-gil, Namdong-gu, Incheon, Korea, 21635

PHONE: +82.32.814.1540

FAX: +82.32.814.5381

Supply Chain Management Users Guide

Matthew Jaster, Senior Editor

First some quick definitions:

Procurement: The process of finding and agreeing to terms, and acquiring goods, services, or works from an external source, often via a tendering or competitive bidding process.

Pandemic: A global disease prevalent to a whole country or the world that can quickly remind gear manufacturers to take a good, hard look at their data processing, information systems, management strategies, and machine technology.

Perhaps the second definition isn't exactly word-for-word from Webster's, but it's safe to assume that many organizations learned a lot about their workflow in the last four months. The new enemy in 2020 isn't a health crisis, a political circus, or an ethics debate when we're strictly talking about manufacturing—it's a battle between being prepared and flying by the seat of your pants.

Case in point: Organizations that have an intricate supply chain mapping process in place have probably fared better in 2020 than those that do not. The companies that embrace technology, get the most out of their software/hardware tools, and put an emphasis on communication will continue to succeed

no matter what supply chain disruptions occur. We asked a few suppliers to provide some insight to gear supply chain challenges during the pandemic.

"Ovako's specialized BQ- and IQ-Steels are a vital raw material for our customers in gear manufacturing, and we have managed reasonably well in maintaining a continuous supply to them. One of the main challenges has been in understanding what volumes to plan our production for, as this is critical to achieve the fine balance between customer satisfaction and effective cost management," said Göran Nyström, EVP Group Marketing and Technology, Ovako.

The most difficult part of getting machine-ready blanks into the hands of more gear manufacturers is awareness and education about the solution, according to Ben Belzer, president and COO at TCI Precision Metals.

"There is a fine line between supply and demand; you either have too much or not enough. TCI is a value-added materials distributor. As a distribution resource customer intimacy is important, especially during these uncertain times. Customer outreach has proven beneficial to maintaining expectations,

Forecasting precision is an essential indicator to help drive planning in the right direction. Photo courtesy of Ovako.



both for customers and for TCI. When things become difficult communications is important. Consideration and communication are a two-way street; it is important that both customers and vendors work together to the mutual benefit of each other and the end customer,” Belzer said.

“We are fortunate that we have not encountered any material supply disruptions, the most difficult aspect has been forecasting demand for our product as many customers have been forced to curtail production as a result of decreased demand,” said Evan Berlin, market manager, oil and gas, at Dura-Bar.

In the last four months, gear manufacturers and the entire metalworking industry have been carefully stepping through uncharted territory.

COVID-19 didn’t wait for the paperwork to go through. There was no audit or training exercise prior to the entire planet shutting down. Navigating through a pandemic starts by “looking within.” How can we do better as a supplier of materials to the gear industry? Have we looked at how automation and data-driven manufacturing can better prepare us for volatile periods in the future? How can we become more practical and deliver improvements to our customers down the road?

Putting action plans in place and addressing *internal* concerns prior to *external* concerns is how many organizations have begun the long climb out of all this uncertainty.

“At Ovako, we have taken precautions to limit any spread of the disease, and we have managed this very well. It is understood by everyone in our business that while we must stay safe, customer service remains paramount. And in these challenging

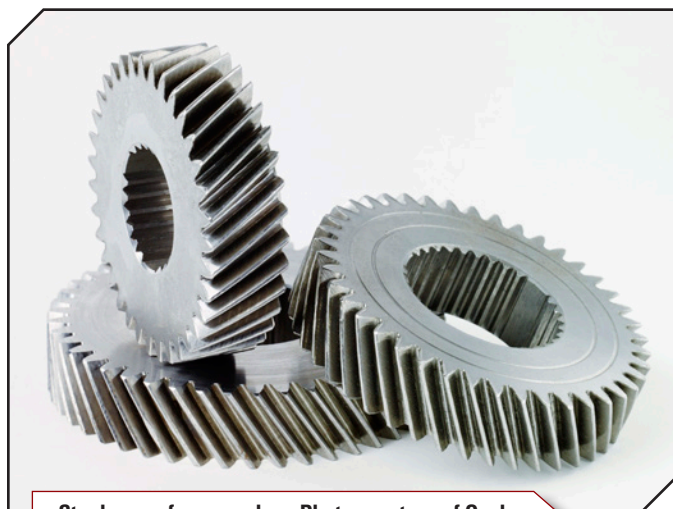

Steel gears for a gearbox. Photo courtesy of Ovako.

and unprecedented customers we have been prepared to do whatever is necessary to maintain our supply chains to meet customer demands,” Nyström said.

TCI Precision Metals is considered an essential business and has remained open throughout the COVID-19 pandemic supplying machine-ready materials to manufacturers, including companies producing ventilators in response to critical needs. “Throughout it all TCI has employed strict PPE policies to ensure a safe workplace environment during these uncertain times,” Belzer said.

Key areas that TCI Precision Metals has put a greater



AMORPHOLOGY

DISRUPTING TRADITIONAL GEAR PRODUCTION WITH NOVEL ALLOYS AND PROCESSES

ADVANCED GEAR PRODUCTION



Flipping the paradigm by reducing machining costs for complex gear production.

POWDERS & COATINGS



A Bulk Metallic Glass coating was applied in a single step, dramatically improving the surface finish.

Request more information @ www.amorphology.com

emphasis on in recent months include flexibility, innovation, a mutual management of expectations in the supplier/customer relationship, quality that can never be compromised, and never losing sight of what the organization is good at.

Dura-Bar has more than 35-million pounds of gray and ductile bar stock in inventory and continues to produce at near-normal rates to ensure it maintains inventory levels that meet the demand — now and in the future.

“Communication has been critical to our success during this time — we are in constant communication with our customers, machine shops/manufacturers, and have daily internal operation and production meetings to guarantee we are producing enough to support our customers when demand increases,” Berlin said.

All the organizations interviewed in this article felt that technology improvements in recent years have helped weather the supply chain storm. The “new normal” is allowing companies to look at the global supply chain from a different perspective.

“By managing remote interactions both between our internal teams and our customers we are learning to become even more efficient in the future. Conferencing systems, file sharing and other digital tools are now a critical element of our business. It has not just been a question of getting these tools in place, we have placed a major emphasis on the training and support that is enabling our employees to use them effectively,” Nyström said.

Berlin agreed, stating that Dura-Bar’s recent Oracle implementation has been extremely valuable during the pandemic.

“We went live with an Oracle implementation just as the current situation began to take hold in the U.S. — we are now more efficient at meeting customer demands, processing invoices,



TCI: Machine-Ready Gear Blanks from TCI are made to order to near net shape. They are flat to within $\pm.002$ " with dimensional tolerances as close as $\pm.0005$ ". A single PO can determine material, heat treating or other processes, and the finished blanks arrive deburred, clean, and packaged to prevent shipping damage, ready to go directly from receiving into the customers' machining center.

altering shipments to meet customer needs, even as they change daily in some instances. In addition to frequent communication with customers regarding our continued production and operations,” Berlin said.

During the COVID pandemic, TCI Precision has seen an increase in special requests, including special handling, and added processing. “The TCI ERP (Enterprise Resource Planning) platform is tied to all the company’s business and manufacturing processes, from the front office to each work cell on the shop floor. TCI is a build-to-order supplier, with close tolerance specifications applied not only to the machine-ready blanks produced, but to every aspect of the customer relationship. When special circumstances arise, technology makes the request not only possible, but seamless,” Belzer said.

Additionally, because machine-ready blanks are close tolerance and dimensionally consistent blank-to-blank, they support automation such as vacuum workholding, robotic loading and unloading, and integrated in-process inspection. These are all areas that will improve lead times and save on manufacturing costs.

While shop floor technology certainly helps, the need for remote services and advanced networking capabilities has been vital during plant shutdowns.

“Innovation and finding ways of doing business has been central to our approach. We have been particularly successful at handling customer interactions with modern conferencing tools,” said Nyström. “And a good example of innovation is that we recently enabled a customer in India to carry out a virtual quality audit of one of our mills in Sweden, simply by using video conferencing on a mobile phone to enable them to tour the facility remotely.”

The most important question in 2020



The entire customer service team is committed to quality when it comes to its continuous cast iron bar stock. Photo courtesy of Dura-Bar.

might be, "How can these organizations tighten the connection between supply and demand for their customers to meet their needs more effectively now and in the future?"

"This indeed is a million-dollar question. And central to this is being able to understand the various interactions within the value chain interaction and gaining transparency of the key figures across the different handover steps. Forecasting precision is an essential indicator to help drive planning in the right direction," Nyström said.

"Dura-Bar's commitment to quality is paramount and our customer service team has remained diligent in following-up and working with our customers as some have altered shipping/receiving hours as well as their operations," Berlin added. "Our entire customer service team remains working at normal capacity remotely at all divisions and we carefully coordinate with our customers to make sure they are fully taken care of and stress-free when it comes to working with Dura-Bar."

Everyone urges the gear manufacturing community to do the necessary research when working with a supplier.

"There are several methods of manufacturing gears and in most cases that decision has been made long before the part reaches the shop floor. Each method has its own set of processes and material requirements before you ever cut tooth one. At TCI Precision Metals we focus on providing value-added material specifically for gears manufactured from solid stock, including aluminum, stainless steel, carbon steel, and many other alloys," Belzer said.

Machine-ready blanks for gears, manufactured from solid material are a lean solution, Belzer added. Blanks can consolidate processes, eliminate material prep and the associated potential for bottlenecks, and reduce inventory with just-in-time delivery of material based on production scheduling. When considering these time saving variables, manufacturers typically realize an increase in production throughput of up to 25%.

"As with most sectors of manufacturing, the gear manufacturing space will feel the pressure of better, faster, cheaper over the coming years. OEM customers will demand more capabilities from suppliers with increased productivity, and shorter lead times. Individual production batches will shrink as manufacturers work to become more agile, driven by end customer demand for greater customization," Belzer said. 

For more information:

Dura-Bar
Phone: (800) 227-6455
www.dura-bar.com

Ovako North America Inc.
Phone: (803) 802-1500
www.ovako.com

TCI Precision Metals
Phone: (800) 234-5613
Tciprecision.com



HIGHLY PRODUCTIVE GEAR CUTTING SOLUTIONS



 **PRECISION**

 **FLEXIBILITY**

 **PRODUCTIVITY**

HLC 150 H
Integrated Chamfering Unit
for Maximum Productivity



K 300
CNC-Machine for Precise
Gear Hobbing



K 160
Innovative Design Principle with
State-of-the-Art Technology



EMAG L.L.C.

38800 Grand River Avenue | Farmington Hills, MI 48335 · USA | Phone: +1 248 477-7440 · Fax: +1 248 477-7784 | E-Mail: info@usa.emag.com

www.emag.com



PROFITABLE PRODUCTION, PERFECTED.

Empower your team with the latest profitable gear manufacturing technology. Call us today to speak with an engineer about your next machine, tool, or service solution, or to learn more about our new NEO Power Skiving machine!



847-931-4121 | sales@heliosgearproducts.com

HeliosGearProducts.com

Gear Blanking Gets Bigger at Forest City Gear

Forest City Gear is doubling down on its strategy to produce most of its critical gear blanks in-house by adding new capacity, and capabilities, to its state-of-the-art 8,500 sq. ft. precision gear blanking facility. The facility, equipped with the latest turning, milling and inspection equipment, gives the company complete control over the quality and delivery of the blanks that are the 'near net shape' starting point for the fine- and medium-pitch cylindrical gears and shafts the company produces. Most importantly, Forest City Gear has succeeded in eliminating a significant bottleneck in its 'Make Complete' value stream and cut turn-around time for blanks from as many as 12 weeks to as little as one or two. That's no mean task given that several dozen different customer orders are usually in the queue, for gears ranging from 1/8" to 8" in diameter, shafts up to 16" long — all in lot sizes as small as one or as many as a thousand.

"We responded to this challenge in typical Forest City Gear fashion: invest in the best, most productive equipment for the job," said Forest City Gear Director of Operations Jared Lyford. "Case in point: our Mazak Quick Turn Turning Centers. They give us a multi-tasking capability so both the critical turning and milling operations can be done on a single machine in one setup for shorter lead times and greater accuracy. Most recently, we've added a Mazak VCN 430A Vertical Machining Center with the added benefit of a fourth-axis rotary table that allows us to process numerous parts that would normally require multiple setups."

The company has also made significant investments in its parts programming capability in support of its blanking operations — most recently in a CIMCO DNC-Max client/server, which Lyford said is the ideal solution for ensuring fast, secure and error-free parts program management and networking. "This DNC system gives us complete control over program transfers, reduces the downtime of having to transfer programs machine to machine via flash drive and allows all our machines to download programs at the same time," Lyford said. "Most importantly, any program changed by the operator and sent back to DNC-Max can be automatically raised in version and/or stored in a quarantine area. This gives us the ability to track changes and revert to any previous version if necessary and mitigate risk downstream."

Next up: The addition of five-axis machining to completely machine products such as gear housings and small planetary carriers. ⚙️

For more information:

Forest City Gear
Phone: (815) 623-2168
www.forestcitygear.com

For Related Articles Search

gear blanks

at www.geartechnology.com

The Power of One²

Your Objective:

One face in perfect alignment with another. *For infinity.*

No problems. No distress. No delays.

That's the same objective you have for choosing your gear producer. Circle Gear's objective is to engage with every customer's objectives.

- ▶ One to 1000 gears
- ▶ Customer designed or reverse engineered
- ▶ Gearbox repair, rebuild or redesign
- ▶ OEM or end-users
- ▶ ISO 9001:2015 Certified

1501 S. 55th Court, Cicero, IL 60804
 (800) 637-9335
 (708) 652-1000 / Fax: (708) 652-1100
 sales@circlegear.com
 www.circlegear.com

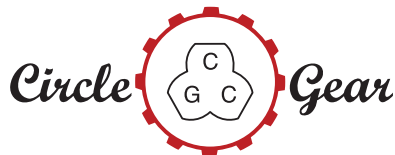

Spiral and Straight Bevel Gears (*Cut, Ground or Lapped*) • Spur Gears • Helical Gears • Long Shafts • Herringbone Gears • Involute and Straight Sided Splines • Internal Gears • Worm and Worm Gears • Racks • Sprockets • ISO Certified



Partnering with QualityReducer to provide Gearbox repair, rebuilding and reverse-engineering.

WE'RE CERTIFIABLE

Our ISO 17025 A2LA Laboratory is available to certify or recertify your Master Gears and Spline Gauges or Contract Inspection of your gears.

Our rapid turn-around service minimizes the "out of service" time.



PENTA GEAR METROLOGY

6161 Webster Street, Dayton, Ohio 45414

937-660-8182
 sales@pentagear.com
 www.gearinspection.com



Sharpening Services

- Hobs
- Milling Cutters
- Shaper Cutters
- Shaving Cutters
- Broaches

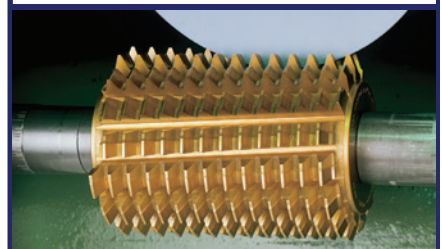

Service Centers

Hoffman Estates, IL

Phone: 847.649.1450
 Fax: 847.649.0112

East Tawas, MI

Phone: 989.362.0414
 Fax: 989.362.2720

Querétaro, Mexico

Phone: 52 442 217 34 45
 Fax: 52 442 217 34 46



sales@star-su.com
 www.star-su.com



Gear Research Institute

GEARS FOR YEARS

Gear Research and Testing Specialists

Aaron Isaacson

(p) 814-865-5832

(e) aci101@arl.psu.edu

gearresearch.org

An ASME, AGMA Institute at Penn State

Sign up for our free newsletter or visit our employment opportunities page today!



PennState

Applied Research Laboratory



Index Technologies

Gear Tool Reconditioning

**HOB & SKIVE CUTTER SHARPENING BY PROFESSIONALS...
FOR THE PROFESSIONAL GEAR MANUFACTURER.**

WE UNDERSTAND YOUR INVESTMENT IN GEAR TOOLS IS SIGNIFICANT. WE GUARANTEE YOUR TOOLS ARE RETURNED ACHIEVING AND TYPICALLY UPGRADING SPECIFIED TOLERANCES. WE HAVE BEEN DOING THAT SINCE 1999.

- HOB SHARPENING
- SKIVING & SHAPER CUTTER SHARPENING
- BROACH SHARPENING
- STRIPPING, EDGE PREPARATION & PVD COATINGS

216-642-5900

Fax: 216-642-8837 • Email: gallen@gallenco.com
5755 Canal Road, Valley View, OH 44125



www.IndexTechnologiesInc.com

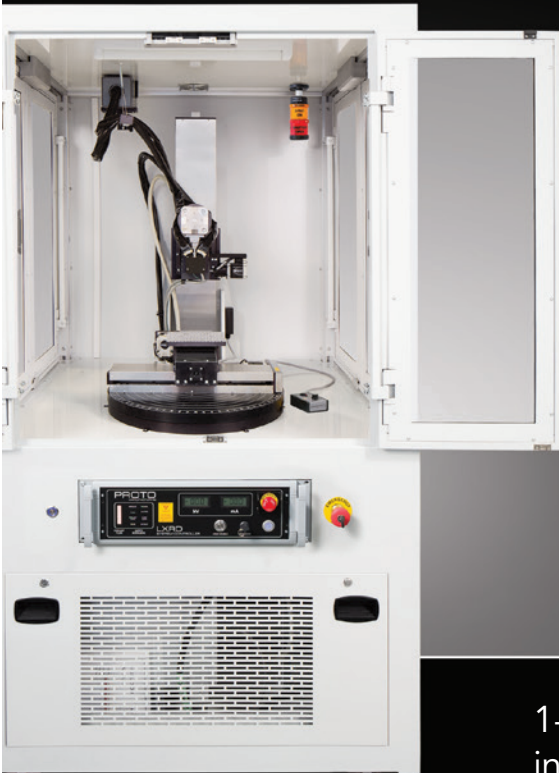

RESIDUAL STRESS MEASUREMENT

State-of-the-art facilities *and* superior service.

No compromises.



www.protoxrd.com

1-734-946-0974

info@proxrd.com

PROTO

X-RAY DIFFRACTION

Gears for the toughest machines on earth.

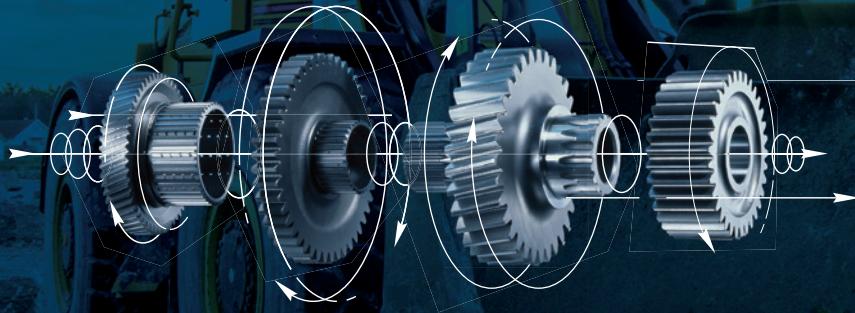

Together, we are the force that moves the world.

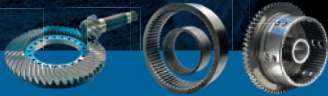

We offer a wide variety of manufacturing capabilities covering almost the entire powertrain and driveline applications.

We make available one of the widest production capability for custom gears for heavy duty vehicles of the entire industry to enable our O.E.M. Customers to focus more on their projects.

IATF 16949 and ISO 14001 Certified



CATTINI NORTH AMERICA
www.cattinina.com
Pedetemplim sed incessanter®

Archeology Just Got Easy

Gear Technology is happy to report that every issue (1984 to present) is now available online at

www.
geartechnology
.com.

Need articles on software, gear grinding, plastics, or lubrication?

Put away your shovel...

They're simply a keyword away.

Drop by our website to uncover decades of peer-reviewed technical and back to basic articles

You don't need to be an archeologist to "excavate" the information that matters to you.

www.geartechnology.com/issues.



UNITE-A-MATIC™
TRUE DIMENSION GEAR INSPECTION

NEW PROGRAM, OLD GAUGE?

UPGRADE YOUR UNITE-A-MATIC™ TODAY

AVAILABLE FOR ALL MODELS



BEFORE



AFTER

- OD/ID CAPABLE
- DIMENSION OVER BALL/PIN
- MAJOR/MINOR
- EVEN & ODD TEETH
- SHAFT CAPABLE
- SPC CAPABLE
- CUSTOM BUILDS
- SHOP HARDENED



UNITED TOOL SUPPLY

851 Ohio Pike - Cincinnati, Ohio 45245 - 513-752-6000

UNITE-A-MATIC.COM

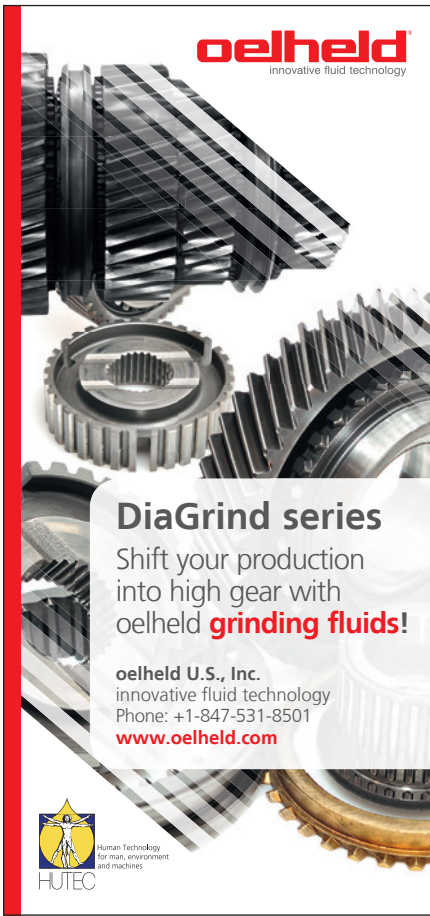

oelheld
innovative fluid technology

DiaGrind series
Shift your production into high gear with oelheld **grinding fluids!**

oelheld U.S., Inc.
innovative fluid technology
Phone: +1-847-531-8501
www.oelheld.com



Dillon Chuck Jaws

 CHUCK JAWS	 HARD JAWS	 JAW NUTS	 FULLGRIP JAWS	 CUSTOM JAWS
 WISE JAWS	 JAW BORING RING	 JAW FORCE GAGE	 CHUCK GREASE	 COLLECT PADS & COLLECT JAWS

Dillon Manufacturing, Inc. **P** 800.428.1133
 2115 Progress Drive, **F** 800.634.6480
 Springfield, Ohio 45505 **dillonmfg.com**
 ISO 9001:2015 - Sold through distributors **sales4@dillonmfg.com**



HobSource Inc
Custom gear cutting tools

**Performance
Dependability
Value**

866.HOB.TOOL
www.hobsource.com



Precision Mechanical Components & Assemblies

Standard Industrial Components | Made To Print Parts

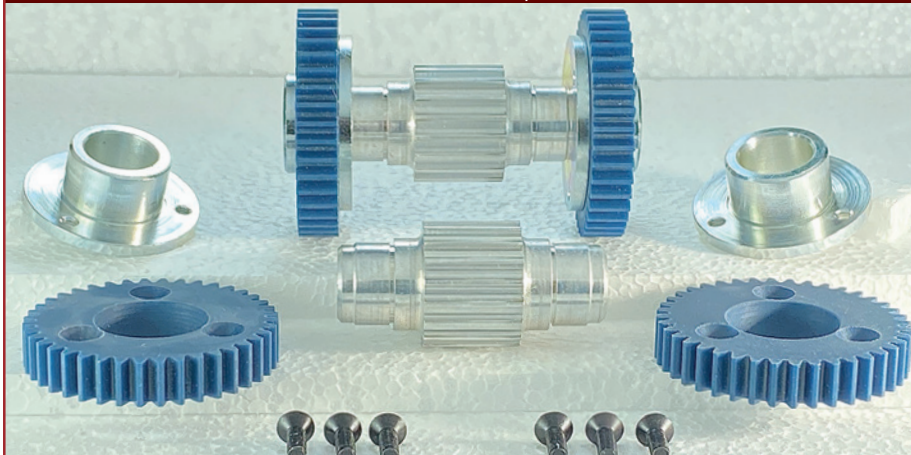

Gears, Pulleys, Shafts, Bearings, Couplings, Fasteners, Custom Gear Boxes
Value Added Features and Services

<ul style="list-style-type: none"> Engineering, Refurbishing & Design Custom Made To Print Parts Modified Standard Parts Assemblies & Sub-Assemblies Custom Mounts For Shafts Build Sub-Assemblies And Complete Assemblies Prototype Work 	<ul style="list-style-type: none"> ▶ Press bearings into pulleys ▶ Assemble bearings to shafts ▶ Set backlash on gears ▶ Assemble drive boxes ▶ Straightening ▶ Welding ▶ Kitting ▶ Plating / Custom Coating ▶ Heat treat 	<p>ADD</p> <ul style="list-style-type: none"> • Grooves • Flats • Keyways • Pins • Threads • Staking • Pressing • Testing
------------------------------------------------------------------------------------------------------------------------------------------------------------------------------------------------------------------------------------------------------------------------------------------------------------------------	------------------------------------------------------------------------------------------------------------------------------------------------------------------------------------------------------------------------------------------------------------------------------------------------------------------	------------------------------------------------------------------------------------------------------------------------------------------------------------



Nordex
INCORPORATED

Nordex.com Sales@nordex.com Eng@nordex.com
Phone: (800) 243-0986 or Call: (203) 775-4877



MADE IN TAIWAN

YAGER GEAR

Your Perfect Gear

- Processing Ability** Module: 0.3~12, Maximum O.D: 400 mm
- Grinding Ability** Module: 1~10, Maximum O.D: 300 mm
- Gear Accuracy** AGMA : 8~12 / JIS B 1704 : 0~4
- Design Software** Gleason CAGE / Gleason GEMS / Klingelnberg KIMOS

Professional Manufacturer of Bevel Gears

- CNC Machines Cutting** Gleason Phoenix II 280HC, Phoenix II 275HC
Klingelnberg Oerlikon C15, Oerlikon C27
- Lapping** Gleason 600HTL / Klingelnberg L60
- Grinding** Gleason 275G / Klingelnberg G27
- Inspection** Gleason 475GMM / Klingelnberg P40
- Gear Tester** Klingelnberg T60



YAGER GEAR ENTERPRISE CO., LTD.

NO. 57, SHIGU LN., GUOZHONG RD., DALI DIST.,
TAICHUNG CITY, 41260 TAIWAN.
TEL: +886-4-24076223 FAX: +886-4-24076218
Website: www.yagergear.com E-mail: service@yagergear.com



Manufacturing sMart

is your resource for the latest in great ideas from our advertisers. Check this section every issue for sMart Engineering ideas and technology.

For information about advertising, contact
Dave Friedman
at
(847) 437-6604
or
dave@geartechnology.com.

Watch Gear TechnologyTV

www.geartechnology.com/tv/



Learn Something New Today!





Hungry for More

Everything you need to be a world-class gear manufacturer – the suppliers, the technical information and the market intelligence – can be found online

gear

TECHNOLOGY®

- The Michael Goldstein Gear Technology Library includes a complete archive of back issues and articles, 1984-today
- Directory of suppliers of machine tools, services and tooling
- Product and Industry News updated daily
- Exclusive online content in our e-mail newsletters
- Calendar of upcoming events
- Comprehensive search feature helps you find what you're looking for – fast!

**FREE Knowledge
Served Daily**

www.geartechnology.com

DIN Q6 Meets DIN Q10—the Need for Modern Internal Gear Production

Dipl.-Ing. Thomas Kleiber, Senior Specialist Gear Development, Schaeffler Technologies AG & Co.

Challenge—Design Space and NVH

A meaningful discussion about noise is quite difficult because the impression of “noise” is quite subjective. Everybody has a lifetime experience with sound / noise and sees themselves as an expert. I carried out such a test with my family and the results can be seen in Figure 1. The exterior noise of an airplane makes just my son “happy,” whereas exterior and interior engine V8 noise makes me happy. The only consensus is—“silence is golden.”

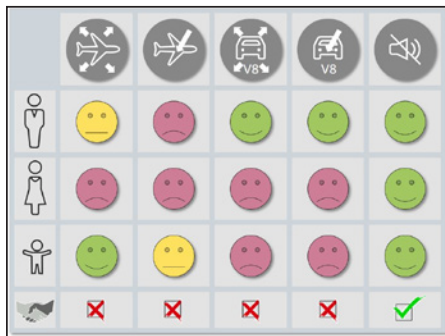

Figure 1 Subjective feeling of noise.

E-cars are by nature on a lower NVH-level, due to the loss of masking ICE noise and to other components getting in the focus, e.g. — e-transmissions, power electronics, e-motors. NVH activities are necessary because these cars are strongly picking up market volume. In the year

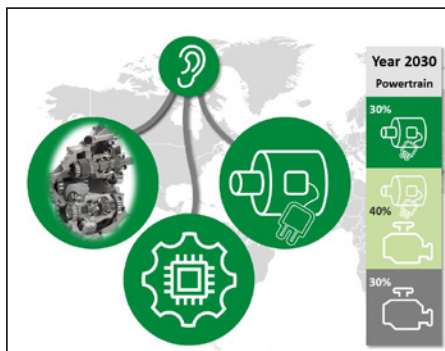

Figure 2 Market development 2030.

2030 it is forecasted to have a split of 30% ICE — 40% hybrid — 30 % e-vehicles.

Transmission engineers will do their best in lowering NVH level, but with the increase of quality, costs will also go up. This “trilemma” must be broken by a compromise between structure-borne noise, airborne noise and costs.

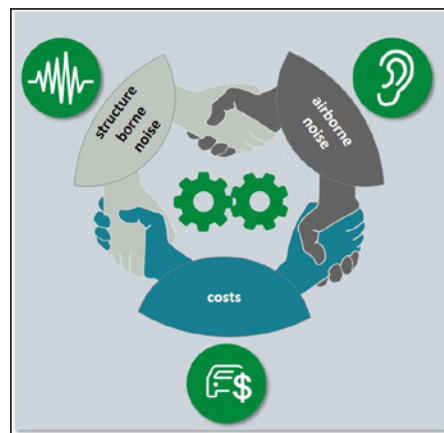

Figure 3 Trilemma gear design.

Conclusion—Integral Understanding Required

“DIN Q6-meets-DIN Q10” is probably not a desirable choice in quality to apply acoustic modification on a planet gear (Fig. 4). DIN Q6 reflects the current feasibility for the mass production quality

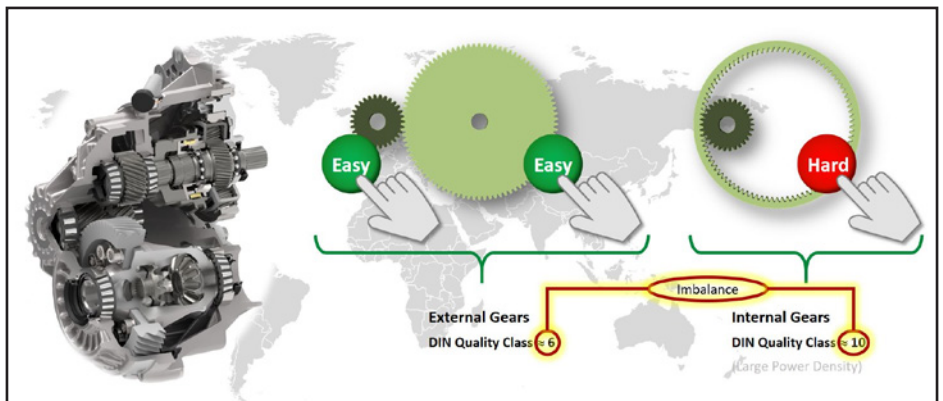

Figure 4 Imbalance of quality.

level of planets and DIN Q10 was in the past a satisfying level for internal gears. In order to boost the internal gear quality to a similar level as external gears, several activities had to occur; it was essential to go into every production step—from raw material to the final parts—including feasibilities and their interaction. QA inspection methods had to be developed to do precise predictions on an expected NVH level.

It proved that a very high knowledge throughout the entire production is mandatory.

Gear Quality—Basics of Quality Classes

Transmission gear noise is influenced by several failures as geometrical deviations, gear tolerances, surface roughness or surface mapping. This report will focus on the gear tolerances.

Noise is always linked with dynamics, meaning that there must be a kind of speed which results in alternations, e.g. — due to driving style, imperfection of parts or alternation of power input. A gear at the input shaft faces speeds up to 20,000 rpm and the accumulated number of revolutions during service life pile up to 1 billion revolutions. The

circumferential speed goes up to 50 m/s. The differential case/final drive gear has a speed of up to 2rpm and the accumulated number of revolutions is around 100 million. This number equals a mileage of about 200,000 to 250,000 km. The speed inside of a differential is much lower, and if no type is losing contact to street, the delta speed between both output sides is less than 50rpm. In case of μ -split test (icy/snowy road), it can go up to 500rpm.

Rotational speed is linked with a recommended quality level of gears. High speed requires lower DIN Q-classes (less deviations, fine quality) so that the

incoming gear should be, for example, in DIN Q5-to-Q6. Due to gear ratio and lower rotational speed, the final drive is sufficiently designed at DIN Q7. Differential gears due to static or low frequency meshing come up with higher DIN Q-classes (more deviations, coarse quality).

The link between the different tolerance classes is done by a geometrical series (Fig. 8); this definition helps to quantify the quality independently from size, width, module and helix angle.

It is easier when the number of the geometrical series is transferred to an x-y plot; the plot shows

that an elevation of two quality classes results in doubling the tolerance; a difference of 4 quality classes quadruple the tolerance.

The diagram (Fig. 9) shows impressively the difference between a DIN-Q6 planet with a DIN-Q10 ring gear in each failure mode.

The imbalance is large for all gear failures and is usually between factor 4 and 5.

Switching the ring gear to quality DIN Q8 results in a much better balancing for the failure modes, so that now the given deviations for the ring gear are only between 2 and 2.5 times higher than the deviations of the planet gear.

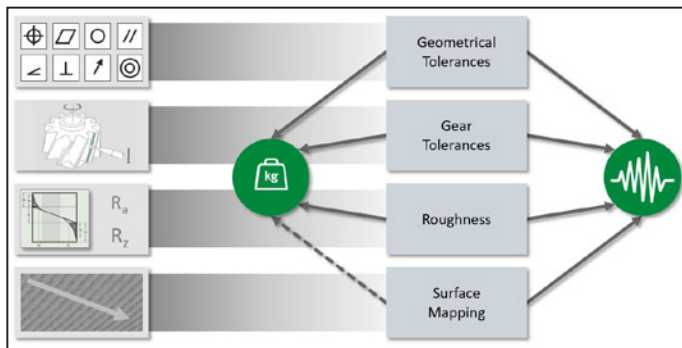

Figure 5 Origin of noise.

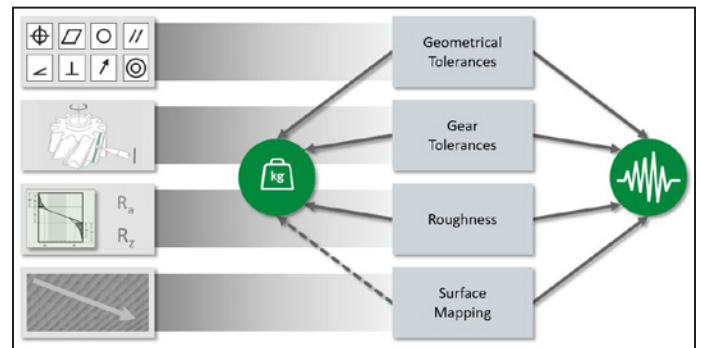

Figure 6 Transmission speed and cumulated revolutions.

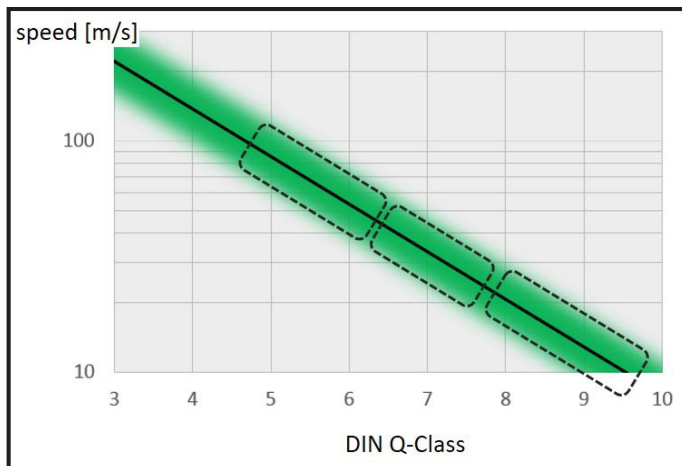

Figure 7 Speed and quality classes.

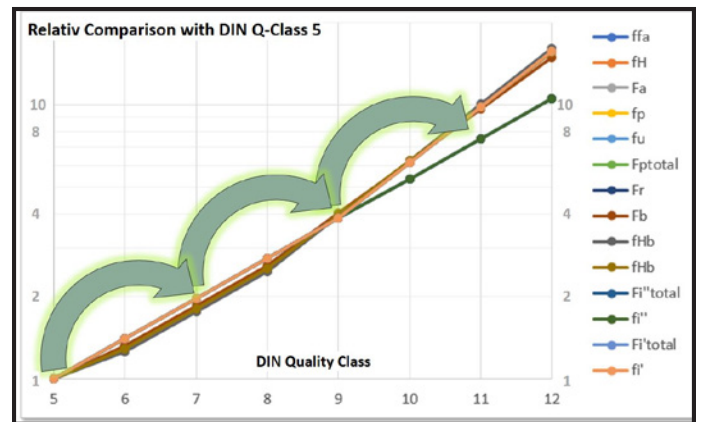

Figure 8 Relative comparison of quality classes.

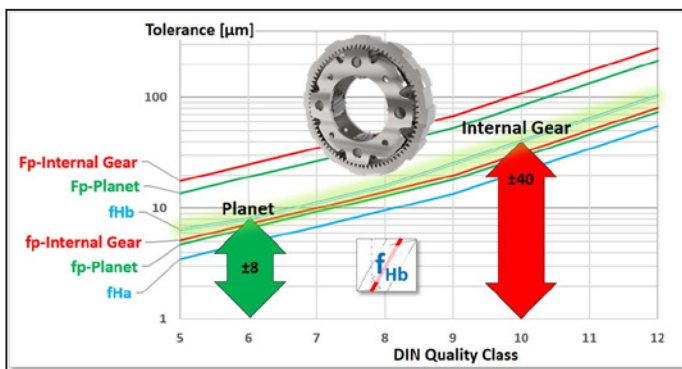

Figure 9 Lead angle error for Q6 planet and Q10 internal gear.

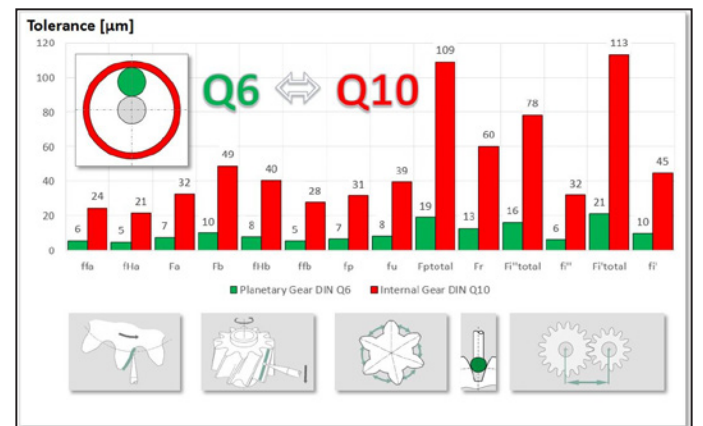

Figure 10 Gear error Q6 and Q10.

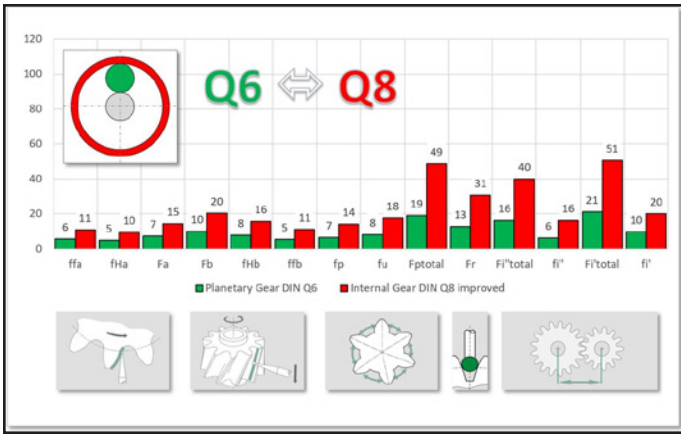

Figure 11 Gear error Q6 and Q8.

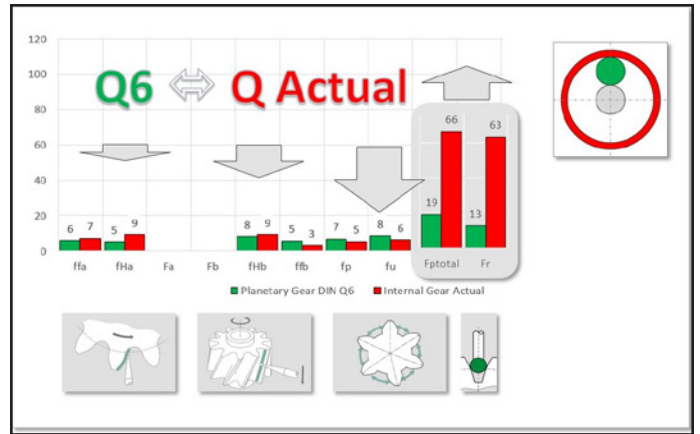

Figure 12 Real internal gear quality.

DIN Q8 for ring gears requires a highly sophisticated production process with robust quality monitoring and good stability after tool reworking operations.

With high-end machining processes, the quality level can be further enhanced. This can be seen especially in the single pitch error fp . On the negative side there is a larger total pitch error for Fp and Fr .

Higher deviations/DIN-Q classes for ring gears derive from the gear geometry itself affecting machining / heat treatment/clamping etc. This is not surprising

because a DIN-quality system does not distinguish between external and internal gears. External gears usually come with a more rigid structure or part design, whereas the internal gears are designed as thin rings with high elasticity and large internal diameter due to gearbox design with high power density. The raw material, heat treatment, gear outside diameter and clamping jigs have higher impact on total errors as Fr , Fp or OBD (on-board diagnostics) span for internal gears with thin rims. But, in general, increased

deviations for Fr , Fp or OBD span do not have to directly result in increased gear mesh excitation and noise.

Different errors of internal gears can be improved by optimizing the machining process, e.g. — tool optimization; proper machine type and machine setting; optimal raw part before machining (residual stresses due to forging); clamping jig; heat treatment (distortions), etc. (Fig. 13).

The data in Figure 12 now looks more satisfying, but a general gear inspection report does not provide a clear link to NVH topics. Acoustic testing of the whole transmission system in the car (Fig. 14) (anechoic chamber/dedicated measuring equipment) must be done with respect to correlation between NVH behavior of the car and the geometric deviations/gear quality of each geared part. The transfer path internal gear, planetary gear set transmission, axle transmission assembly, car and finally to driver's ear is quite long, and testing is time- and cost-consuming. Inspecting each geared part by 3-D coordinate measuring is desirable for every gear expert, but horrible due to costs and effort in gear measurement. Cost-effective measurement methods like double or single flank inspection are in focus when it comes to create correlations between gear quality and NVH behavior of the whole system.

These simple inspection methods then can be used to prevent added-value in case of insufficient NVH quality. Schaeffler is a large global player in automotive engineering, with a lot of experience in bearing quality inspections. Gear quality inspection is in this case highly inspired by methods used for bearings.

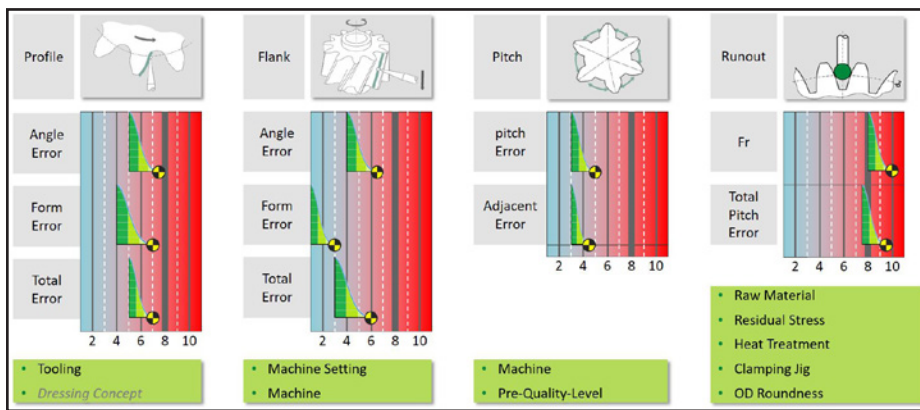

Figure 13 Options to tune quality.

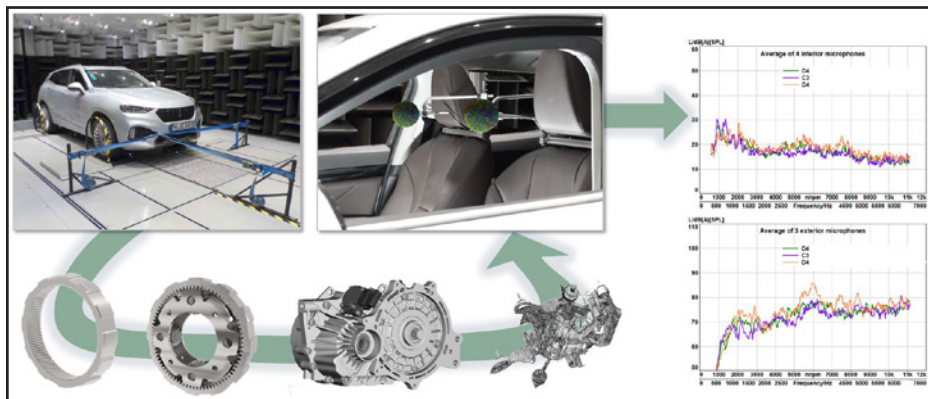

Figure 14 NVH analysis.

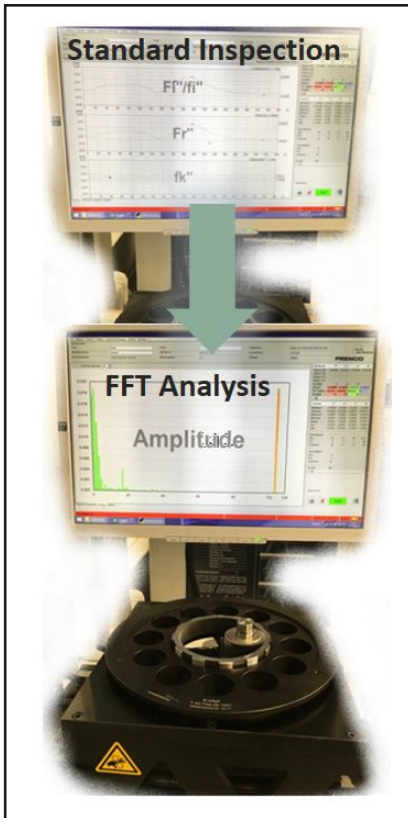

Figure 15 Double flank inspection.

In some points bearings and gears are quite similar — especially when getting to the point of inspecting waviness effects. Here Schaeffler found large similarity between transmission error, accelerations and noise.

The double flank inspection (Fig. 15) is a standard device to inspect gear quality. It is, compared to 3-D gear inspection machines and single flank inspector, inexpensive, fast and robust; the key point is the FFT analysis. By using raw data of the double flank inspection for a post-processing transferring, time-based signals into frequency-based deviation analysis on each part, it is easy to distinguish poor and good gear production and to have a much deeper look into machine properties (Fig. 16). Deviations or resonance effects, e.g. — during the machining process — will directly lead to periodic deviations in quality which will be directly highlighted to the quality inspector by FFT analysis. On the left side, there is a manufacturing with production difficulties in mode 7 and between 16 and 20; parts are exceeding the first design level NVH line “SAG-2FI-X00.” The right side shows an optimized production which stays everywhere below the acceptance

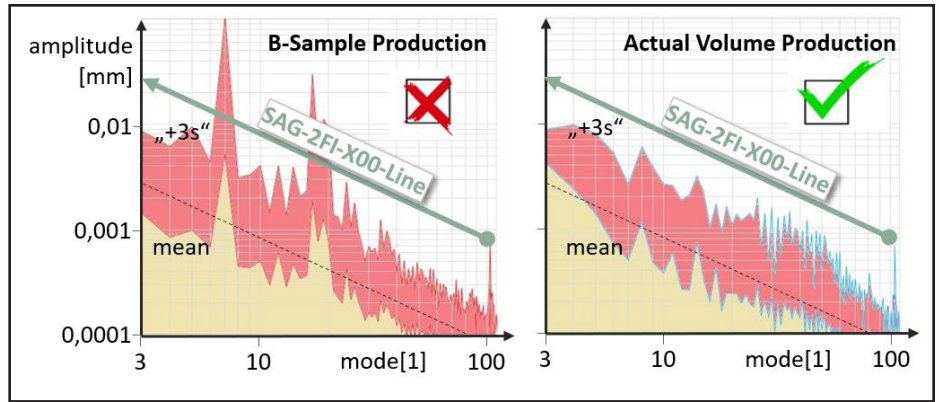

Figure 16 Good and poor internal gear quality.

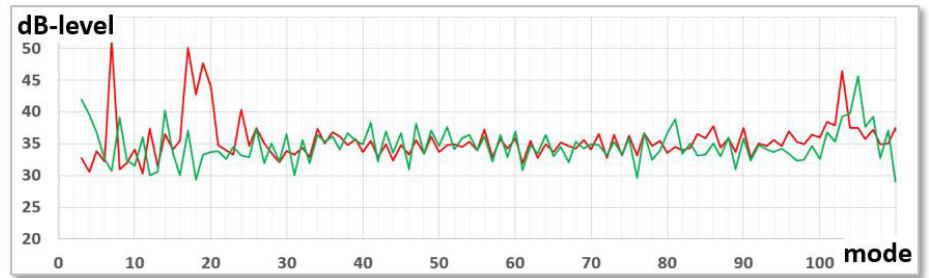

Figure 17 dB noise level after double flank inspection.

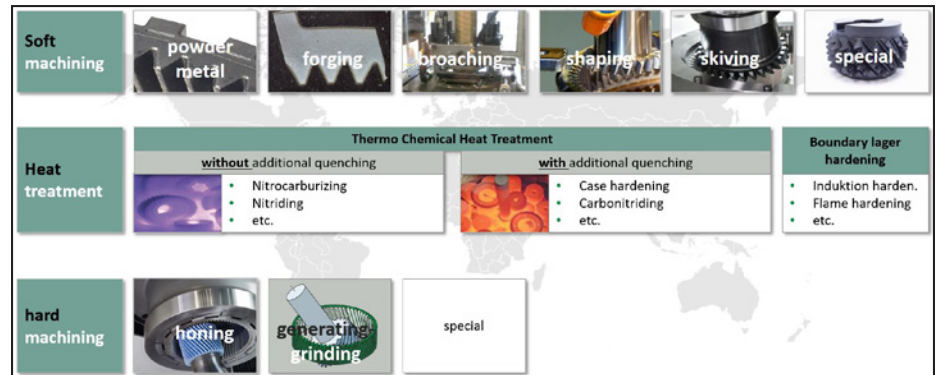

Figure 18 Comprehensive understanding.

criteria.

An additional view was created to support NVH criticality rating. Several tests proved that this method has good correlation with cost- and time-consuming NVH testing in an anechoic chamber. Schaeffler is now able to express part NVH severity before it goes into additional value-add production steps.

Manufacturing

There are many methods and processes for manufacturing of internal gears, and there is no royal road to the best “no NVH” gear. Several developments over the last years revealed that surprisingly many processes and process combinations can pave the road to the best compromise (cost ↔ NVH). The saying “Do the right thing, right!” are indeed words

of wisdom. It goes without saying that the “compromise” is very much driven by the short development time in e-mobility and still the small and medium volume of parts.

NVH is one of the results in overall system performance with lots of influences like transfer path, structural resonance behavior and noise excitation. Regarding the gear mesh excitation for some parameters in gear geometry, there is a trace to its source in soft machining or even before (Fig. 18). A comprehensive understanding is the road to success. The comprehensive understanding requires a data mining concept (Fig. 19) which gathers all the information in the parts life cycle, e.g. — data of the raw material, information of the forging process, heat treatment parameters, machining

information, measurement results of gear geometry after each process step in gear production and creates the ability of comparing them to NVH behavior of the overall system (car, gearbox on test rig etc.). Significant parameters — or even groups of parameters — can be highlighted and optimized due to better NVH performance. On the other hand, robust parameter groups can be used to optimize gear machining and production processes due to costs and efficiency. ⚙️

For more information.

Questions or comments regarding this paper? Contact Thomas Kleiber at kleibtom@schaeffler.com.

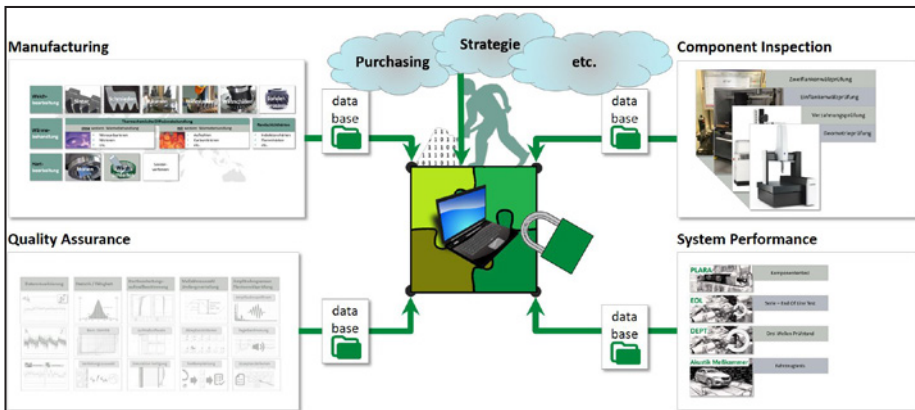

Figure 19 Data mining as one key to optimize NVH and process efficiency.



Dipl.Ing. Thomas Kleiber studied mechanical engineering (1990–1996) at the University Kaiserslautern, including earning while on scholarship a masters degree (1995) at Korea Institut of Machinery and Materials, Changwon/Korea. He began his career (1996–1998) at Schaeffler as a trainee for application engineering in transmission and engine activities. In 1999 he was located in Ansan/Korea providing technical support. Other experience includes (2006) dDesign engineering — engine cam shaft phasers; (2009) R&D of inner transmission shifting units; (2011) as application engineer for manual shift transmissions and new gear system application for the Korean market. Kleiber has since 2011 been a founding member of Schaeffler's gear design department, including: Load data analysis / load estimation / test spec definition; gear design, gear calculation; specialist internal gears production technologies; gear training seminars in Germany, Korea, Japan, China; sourcing support / supplier development; student education (Bachelor & Master); and statistical analysis of big gear data sets.

GOTTA GET BACK IN TIME...

It may not be as impressive as a DeLorean, but if time travel is your thing, we have you covered at

WWW.
geartechnology
.com

Today, our user-friendly archive (1984 to present) is now available online with an optimized search engine that allows subscribers to locate specific articles using keywords and phrases.

We've created a database where subscribers can peruse more than thirty years of gear manufacturing articles without leaving their desks.

In an era where content is king, let *Gear Technology* be your destination for the past, present and future of gear manufacturing.

www.geartechnology.com/issues.

Our Librarian Will Never Shush You
at the **GT LIBRARY**



That's because the MICHAEL GOLDSTEIN GEAR TECHNOLOGY LIBRARY is all online, and you can visit it anytime. Just go to www.geartechnology.com and use the search box for access to 36 years of technical content focused on gears.

- **Every issue since 1984**
- **More than 2,000 technical articles**
- **More than 6,000 archived news items**
- **Addendum, Publisher's Page, Back to Basics and more**

And the best news of all? You don't even need a library card. That's because the GT LIBRARY is open to everyone. Knowledge is free. All you have to do is go and get it.

www.geartechnology.com

High Traction Differentials

Dr. Hermann J. Stadtfeld

How a ratio change can improve traction. The schematic graphic (Fig. 1) shows an unrolled differential with the planetary pinion in the center and the side gears left and right. Forward driving is accomplished in this model by moving all three gears from their top position in Figure 1 to the middle position and down to the lower position. In case of good traction, this is happening without any relative rotation of the three shown differential gears. In case the left wheel (which is connected to the left-side gear) slips, then in the model the left-side gear will rotate clockwise, while the unit moves downwards in the graphic. This will cause a counterclockwise rotation of the planetary pinion while it rotates together with the differential carrier around the axis of the two side gears.

In the model this means the right-side gear rotates clockwise with the same speed as the carrier does. The carrier rotation adds to the left-side gear rotation, which makes the left wheel of the vehicle spin with twice the rpm of the carrier. On the right side, the carrier speed offsets the right-side gear speed, such that the right wheel is not rotating at all. The vehicle is stuck, with no torque on the right-side wheel and no traction on the left-side wheel.

In the high-traction differential, the ratio between the

planetary pinion and the side gears changes as a rotation like described happens. The rotation shown in the graphic from bottom to top moves the line of action from a small radius R_2^* in the right-side gear and a large radius R_1^* in the planetary pinion, to an increasing radius of the right-side gear and a decreasing radius of the planetary pinion. At the middle graphic, the line of action crosses the pitch line at the center distance line, which splits the center distance exactly in the two pitch radii. This means the ratio is equal to the division of the number of teeth of the sun gear and the planetary pinion (also: ratio = R_2/R_1). The ratio in the bottom graphic is smaller and the ratio in the top graphic is larger due to the line of action shift. The engagement between the planetary pinion and the left-side gear behaves in the opposite way, which squares the ratio increase factor from bottom to top.

In the case of a differential with involute teeth (constant ratio), the contact force, which was reduced by the free spinning left wheel, will first reduce and then eliminate the traction of the right wheel. The high-traction design will, in the case of a left-wheel traction loss, instantly increase the ratio, which accelerates the left wheel. The acceleration causes a reaction torque in forward driving direction on the non-rotating right wheel. In other words, at the instant the planetary pinion reduces the contact force to the right-side gear, the ratio change will compensate this due to the increase of the lever arm R_2^{**} and “inject” a torque spike to the right wheel.

Of course, after one tooth mesh the sequence starts at the bottom of the graphic again. So what happens now? Nothing to worry about, in the contrary! At first, the ratio becomes low, which reduces the speed of the left wheel, such that the acceleration cycle can begin again, and the next torque spike to the right wheel in driving direction, can be generated. As long as the spinning wheel has some friction contact, the speed reduction of the spinning wheel by the ratio change will only prepare the differential for the generation of the next torque spike to the wheel with traction. The kinetic energy, stored the rotating differential carrier and the spinning wheel will remain nearly constant, while part of this energy is shifted between the spinning wheel and the differential carrier — without influencing transmission or engine of the vehicle.

One complete cycle of the sequence (Fig. 1) only lasts a fraction of a second, which is why the unit constantly provides torque impulses to the wheel which has traction, while the other wheel spins free.

The high-traction differential works like a reverse ABS. It gives active torque impulses, not just passive break application, like most electronic traction control systems.

The solution. A ratio factor $f_{R-Top} = x / y$ is defined. This is the maximal change of the ratio from the pitch circle to the top of the sun gear. A second ratio factor f_{R-Root} represents the maximal

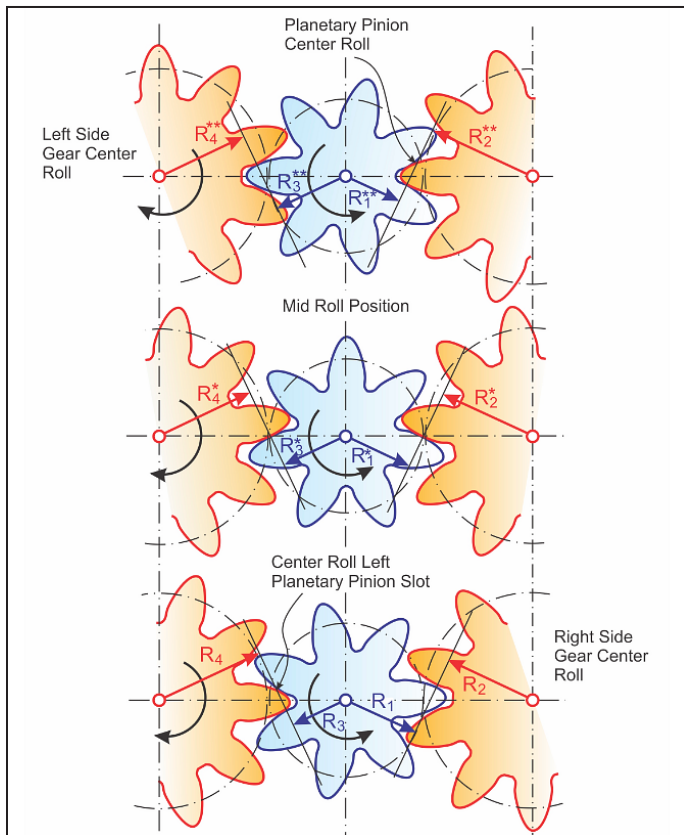

Figure 1 Principle of ratio change, from bottom to top.

(The following is another chapter from Dr. Hermann J. Stadtfeld's new book, Practical Gear Technology, part of an ongoing series of installments excerpted from the book. Designed for easy understanding and supported with helpful illustrations and graphic material, the e-book can be accessed for free at Gleason.com)

change from the pitch line of the sun gear to its root. f_{R-Root} is $1/f_{R-Top}$.

Y_{Top} is the factor; the effective gear radius has to change from pitch to top \rightarrow

$$R_{eff-Top} = R_{Pitch} \cdot Y_{Top}$$

Y_{Root} is the factor; the effective gear radius has to change from pitch to root \rightarrow

$$R_{eff-Root} = R_{Pitch} \cdot Y_{Root}$$

X_{Top} is the factor; the effective pinion radius has to change from pitch to top \rightarrow

$$R_{eff-Top} = R_{Pitch} \cdot X_{Top}$$

X_{Root} is the factor; the effective pinion radius has to change from pitch to root \rightarrow

$$R_{eff-Root} = R_{Pitch} \cdot X_{Root}$$

In the manufacturing straight bevel gear generator, the cutter cone distance is basically equal to the mean cone distance, which is R_M . If the effective radius of the gear has to change, while R_M remains constant, then this can be accomplished with a ratio of roll change.

It is at the center of roll:

$$RA = R_M / R_{Work} \quad (1)$$

delivers in the center of roll position the predetermined $RA = RA_0$

It should be realized at the gear top:

$$RA_{Gear-Top} = R_M / (R_{Work} \cdot Y_{Top}) = RA_0 / Y_{Top} \quad (2)$$

It should be realized at the gear root:

$$RA_{Gear-Root} = R_M / (R_{Work} \cdot Y_{Root}) = RA_0 / Y_{Root} \quad (3)$$

This provides sufficient information to construct the graph (Fig. 2); RA versus Δq or ΔW . Because of the difference between center of roll to top roll, and center of roll to bottom roll the graph (Fig. 2) is nonlinear. From its characteristic, a third order function is chosen in order to adequately approximate the graph.

$$RA = a + b\Delta W + cD \cdot W^2 + d\Delta W^3 \quad (4)$$

The following boundary conditions are utilized to define the four coefficients in the RA equation:

$$\Delta W = 0 \Rightarrow a = RA = RA_0 \quad (5)$$

horizontal tangent at center of roll:

$$RA' = 0 \text{ at } W = 0 \Rightarrow RA' = b + 2c\Delta W + 3d\Delta W^2 \Rightarrow b = 0 \quad (6)$$

at the root roll position:

$$\Delta W = \Delta WE \dots \text{delta root roll angle}$$

at the top roll position:

$$\Delta W = \Delta WA \dots \text{delta top roll angle}$$

Formulae (1) through (6) deliver the required coefficients. Now a coefficient comparison between formula (Ref. 4) and the Gleason modified roll formula will compute the machine basic setting modified roll coefficients.

Since Coniflex uses different basic settings and a sign change in the roll positions between the two flanks of one slot, the coefficients are calculated independently for the upper and lower Coniflex cutting.

In the pinion, the RA values have to be calculated separately using the X factor and the pinion RA_0 .

The application of the high-traction principle. The ratio factor f_R can be defined to realize the desired ratio change. In the Rockwell paper "High Traction Differential" from 1969 a theoretical value of 24% ratio change was used for the explanation.

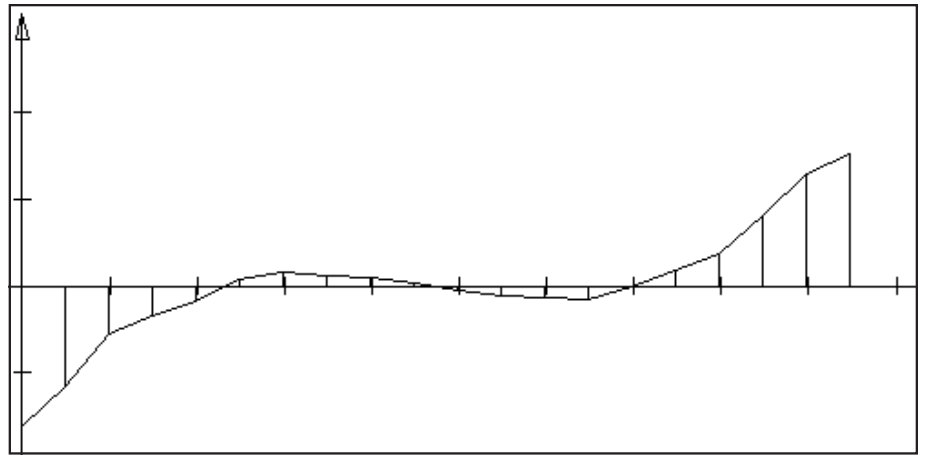

Figure 2 Coast side ratio change along roll positions.

Developments in 1970 have shown that such a large change causes pointed topland on the gear member and severe undercut on the pinion member.

The developments, tests and optimizations during the years of high-traction applications, a standard of 15% ratio change between top and bottom roll position was found best-suitable, not only regarding tooth form but also regarding the function of the differential. Higher values showed unacceptably high tooth mesh impact, which eventually could cause unit failure due to tooth fracture.

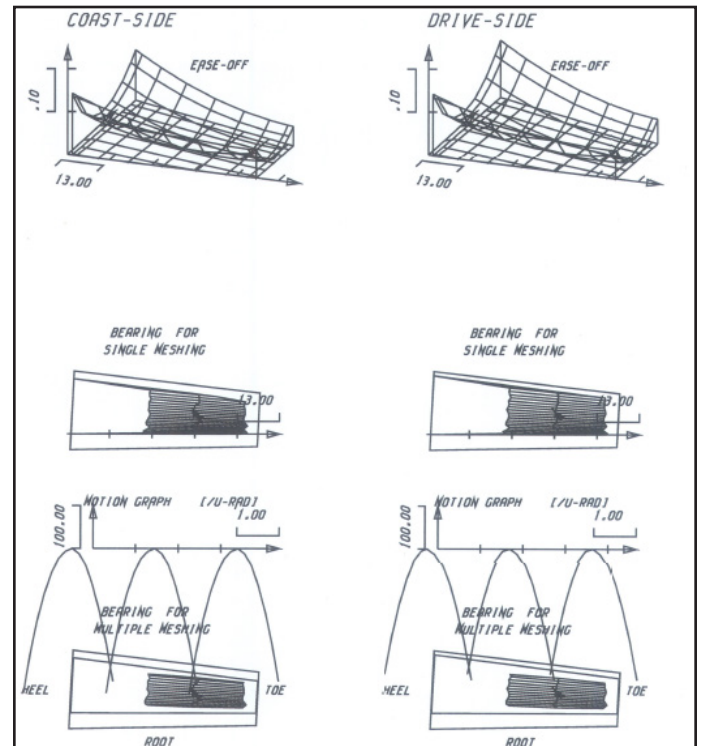

Figure 3 Ease-Off and TCA of regular straight bevel gear design.

Standard top ratio factor: $FR_{tp} = 0.93$

Standard root ratio factor: $FR_{rt} = 1 / FR_{tp} = 1.0753$

Overall ratio fluctuation factor: $FR_{Total} = 1.15 \Rightarrow 15\%$

The TCA of a Coniflex example as baseline is shown (Fig. 3). The simulation result of the ratio change between pinion and

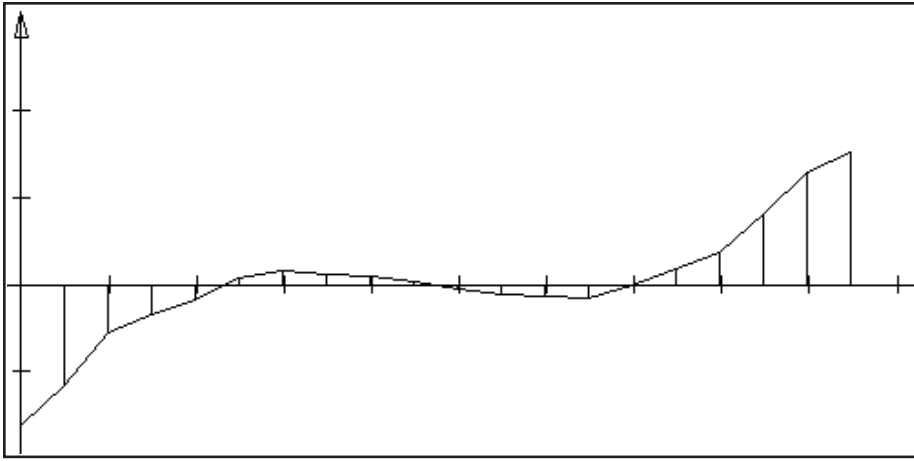

Figure 4 Coast (top) and drive side (bottom) ratio change along roll positions.

gear is plotted (Fig. 4). The 2 ratio graphs resemble exactly the desired characteristic.

A TCA of the same Coniflex gearset but now with high-traction profile by means of fourth-order modified roll is shown (Fig. 5). The Ease-Off topography shows a fourth-order function in profile. This is the world's first analytic tooth contact analysis ever made from a high-traction tooth profile. The Ease-Off shows a "Wildhaber-Novikov"-style shape. However, in case of Wildhaber-Novikov gearing, the modification of both interacting profiles will cancel in the interaction and result in constant transmission ratio. Here, two opposite modification curves result in an Ease-Off that shows the interaction between the two modified profiles as a W-shape.

The W-shaped Ease-Off is exactly as it was expected. The motion errors in Figures 3 and 4 also show that the modified

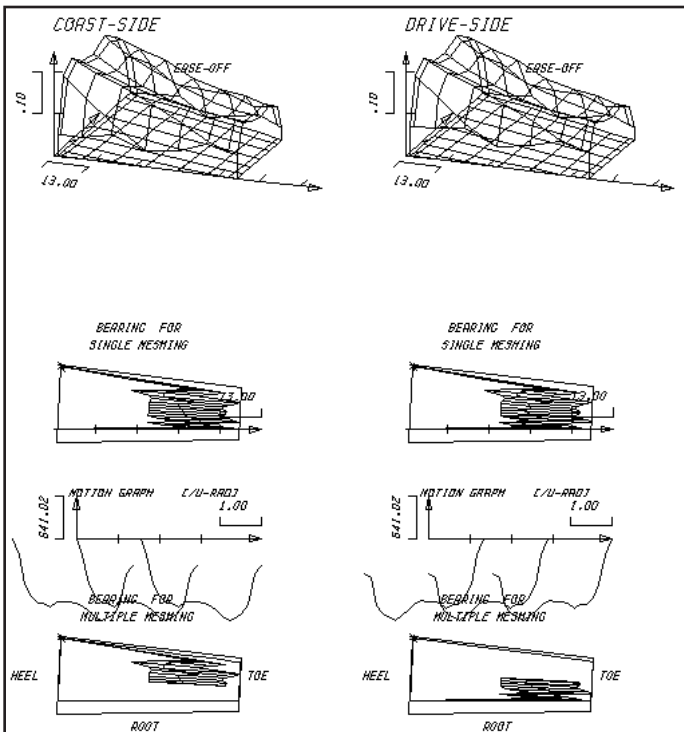

Figure 5 Ease-Off and TCA of high-traction design.

profile is a "textbook-like" duplication of the desired effect. The first derivative of the motion graph is the ratio modification (a fourth-order becomes a third-order).

It is remarkable that the tooth contact pattern still exists and a rolling without hard contact or interference lines occurs. The fuzzy left and right borders of the tooth contact can be explained by the dramatic Ease-Off and the numeric difficulties of the program algorithms to handle this complex tooth profile. However, it is expected that real machined high-traction differentials show some of this fuzzy appearance before the surfaces are broken in.

Practical results. The photograph (Fig. 6) shows a 7×12-tooth high-traction differential development, which is the subject of the discussions in this section. The teeth are coarse with respect to the size of the gears with a large whole depth of the teeth. This is required in order to provide sufficient profile depth for the functionality of the high-traction involute modulation.

Figure 7 shows on top the calculated motion transmission result of a 7×12-tooth differential (2Nm gear torque simulated). The graphic underneath shows the motion graph as it was mea-

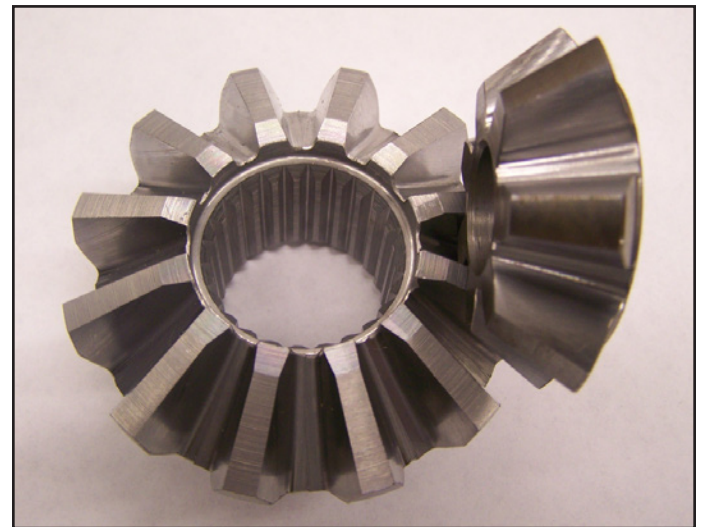

Figure 6 Practical example of a high-traction differential gear set.

sured on a single flank tester under 60rpm pinion speed and a gear torque of also 2 Nm. Between the intersecting points of the calculated motion (top) and the lower peaks of the graph, the displacement is 6,160 μ rad. The lower graphic shows a displacement of only 4,000 μ rad and the center peak of the calculated graph is smoothed out. The characteristic of both graphs, calculated and real measurement are very similar. This differential was manufactured applying the third-order function discussed in section "Solution."

The ratio change has been calculated by deriving the transmission graph according to gear roll angle. The result is shown in the two diagrams (Fig. 8, top). The first diagram is calculated

considering load-affected surface deflections for a gear torque of 50Nm. The diagram underneath was calculated for a very low gear torque of 2Nm. Low load seemed to cause more numerical instability of the calculations and lead to peaks. Random appearing peaks are caused by applying a derivative to a function which already contains waves and peaks. However, the red, S-shaped curve, or the straight line might reasonably represent the ideal form of the graph. The positive and negative amplitudes multiplied with the scaling factor of 0.02 result in a 7.6% ratio change along one tooth mesh. The desired ratio, due to 2 gear meshes, will be $1.076^2 = 1.15$, equal 15%.

The bottom graphic (Fig. 8) shows the angular velocity change. This numerical derivation was conducted from the measured single-flank data. The waviness of the climbing graph stems from the derivation of an already slightly wavy single-flank curve. Also here an S-shaped curve and a straight line were used to imply a realistic approximation of the graph. The magnitude of change is $\Delta W = 235,000 \mu\text{rad}/\text{sec}$ i.e. $-0.235 \text{rad}/\text{sec}$. The angular velocity of the gear during the measurement was pinion $2\pi \text{rpm}/(\text{ratio} \cdot 60) = 3.665 \text{ [rad/sec]}$.

The maximal ratio change is calculated as:
 $\Delta\omega/\omega = 0.235/3.665 = 0.064$, which is equivalent with 6.4% ratio change

The transmission of torque from the spinning wheel to the wheel with traction involves 2 tooth meshes — from the second-side gear to the pinion to the first-side gear. As such, the total ratio change is the square of the ratio factor (1.064):

Total ratio change = $1.064^2 = 1.13$, which is equivalent to 13% total ratio change.

High-traction kinematics. The case of traction on one wheel, represented by the locked lower side gear (Fig. 9) will cause a rotation of twice the speed of the upper-side gear, which slips in the present example. The pinion has to be shifted horizontally in order to generate realistic motions in the model. The lower tooth mesh moves the contact on the lower side gear tooth from root to top (gear drives pinion). This is equal to a reverse execution of the velocity change in the bottom graph (Fig. 8); in other words, it is attempted to reduce the velocity of the side gear. Since this is not possible, the pinion velocity in turn will be increased (acceleration). In the case of the upper mesh in Figure 9, the pinion drives the gear, where the tooth contact of the upper-side gear moves from top to root. This is consistent with an execution of the velocity graph at the bottom of Figure 8, from left to right.

Subsequently, this causes a speed increase of the upper side gear (acceleration). The addition of the accelerations caused

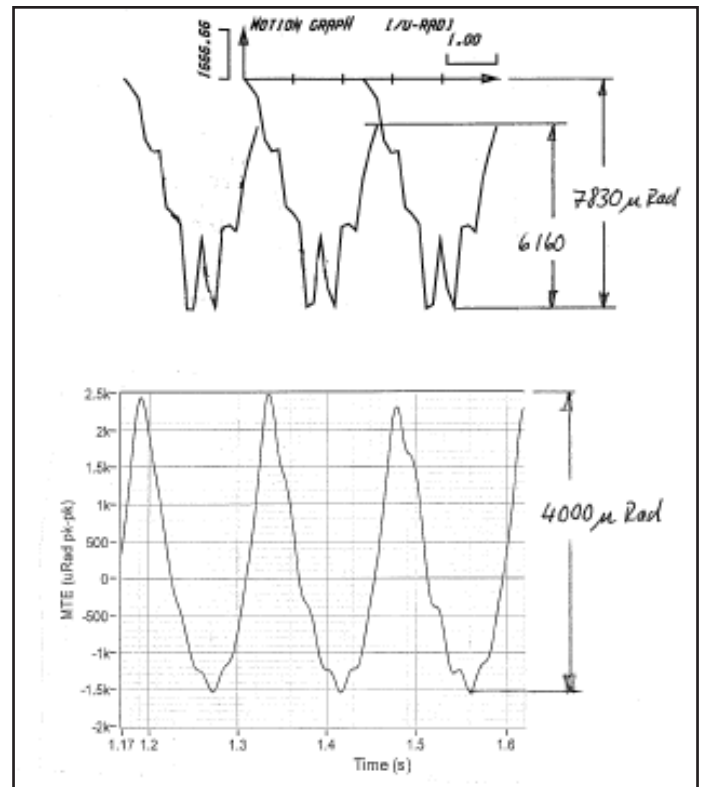

Figure 7 Motion graph, calculated (top) and real single-flank test (bottom).

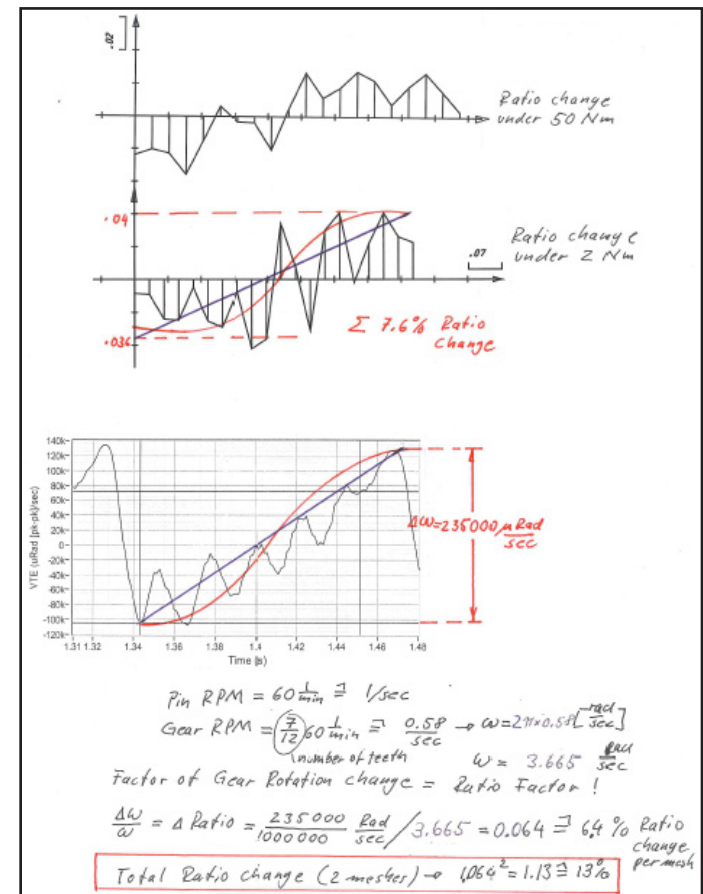

Figure 8 Calculated ratio change (top) and measured angular velocity variation (bottom).

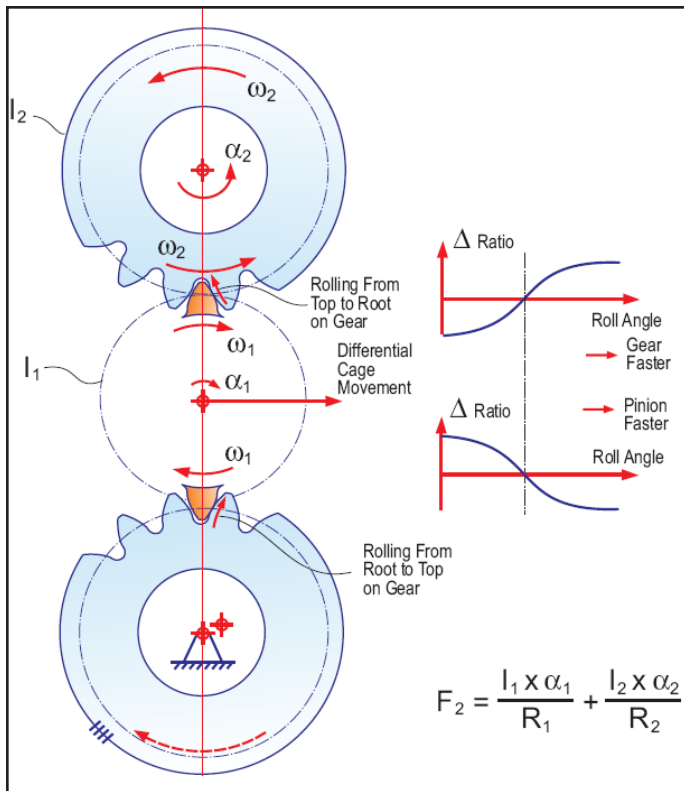

Figure 9 High-traction function, part 1.

from the lower and upper tooth mesh multiplied with the inertia of the free spinning drive shaft and wheel creates a reaction force F_1 . This reaction force F_1 plus a small force (from accelerating the differential pinion) will be generated in order to establish equilibrium in the differential unit. This reaction force F_2 (Fig. 10) at the bottom only lasts a fraction of one second. It is an active torque impulse, which is applied to the wheel with traction and causes a small vehicle movement.

As the unit keeps rotating and reaches the highest speed increase, the speed graph drops down and the speed increase repeats. The drop down will not cause a deceleration (negative force), but only eliminate the force for some milliseconds.

Final Remarks

High relative motion occurs in a differential only if one wheel spins free. Driving through curves only causes moderate relative motions. In case of high relative motion (like rolling the gearset on a roll tester) the high-traction differential causes certain vibration. Such a situation only happens in cases of traction loss of one wheel. Only then are the impulses in the tooth mesh detectable and lead to increased noise emission.

The high-traction differentials manufactured in the past had been machined on two tool generators. The third-order, modified ratio of roll that was applied as a roll cam modification might have arrived at the flank surfaces. However, in older machines with the typical generating flats, it is questionable if the 2 inflection points and the horizontal tangent at the pitch line of the high-traction modulation really arrived at the flank surfaces. So, when high-traction differentials were tested in the past and showed noisy and rough rolling on the roll tester, this was the only proof of a successful high-traction development. What

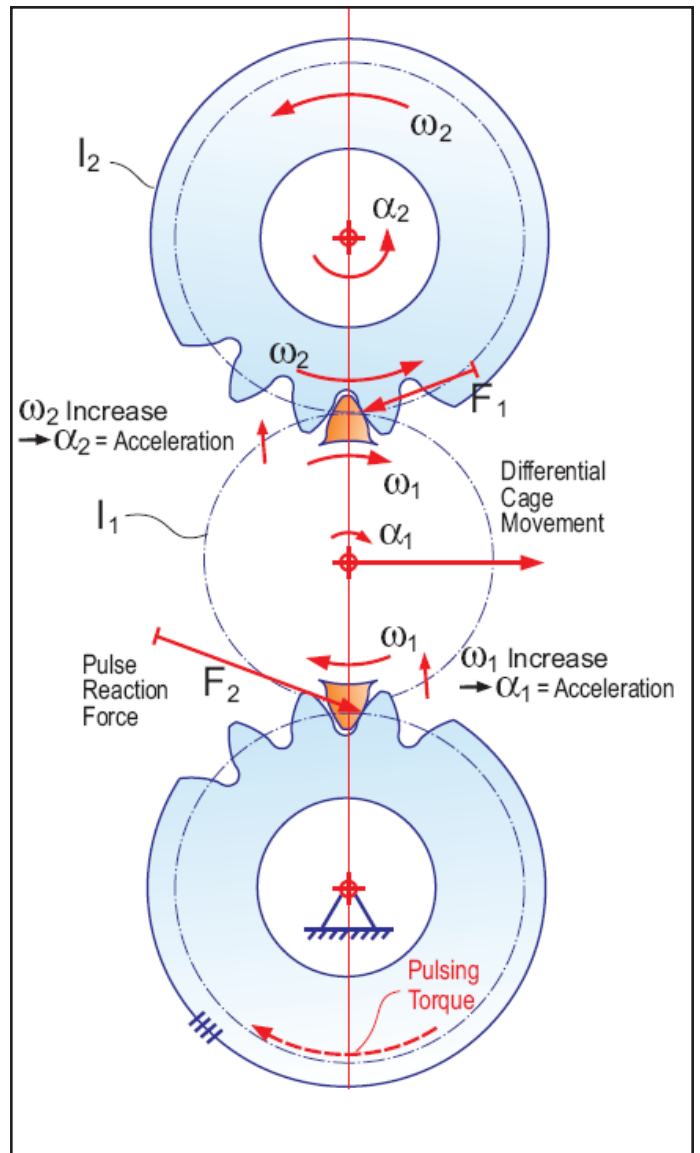



Figure 10 High-traction function, part 2.

a proof, considering the fact that a straight bevel gear set with a pressure angle error in one member also rumbles in the roll tester. There was no precise method of manufacturing high-traction differentials and no way to perform surface measurement against a theoretical master. In other words, the high-traction differentials of the past were “watered down” versions of what the inventors originally intended. Many of the high-traction differential gears have been converted to forging, where the die masters had been machined with 30-year-old two-tool generators. This was diminishing something that was already diminished and not much of the originally intended function was left.

The new method shown in this report allows to utilize a dry, high-speed carbide cutting process (PowerCutting) on modern CNC Phoenix free-form machines. The process is called ConiflexPlus and utilizes peripheral carbide stick blade cutters with Pentac blades. The curved root line versus the two-tool geometry can be minimized if a 15" cutter diameter is chosen. Surface finish and accuracy are high and AGMA quality 11 is standard. The manufactured gears can be measured against nominal flank surfaces, predetermined by the Coniflex analysis

software. Also, correction and a closed loop environment is a standard feature available for the new generation of high-traction differential gears. Today high-traction gears show their full potential. Compared to their predecessors, made on mechanical machines or forged, the new high-traction differential runs much smoother, with little noise, and their traction enhancement is excellent. 

References

1. N.N.High-traction differential — a differential that “uses its head” Rockwell-Standard, 1969.
2. Pastor, A.Engineering Report No. 5181. Cam Calculation, Gleason, February 7, 2011, originated 1975 to 1977

For more information.

Questions or comments regarding this paper? Contact Dr. Stadtfeld at hstadtfeld@gleason.com.

Dr. Hermann J. Stadtfeld is the Vice President of Bevel Gear Technology and R&D at the Gleason Corporation and Professor of the Technical University of Ilmenau, Germany. As one of the world's most respected experts in bevel gear technology, he has published more than 300 technical papers and 10 books in this field. Likewise, he has filed international patent applications for more than 60 inventions based upon new gearing systems and gear manufacturing methods, as well as cutting tools and gear manufacturing machines. Under his leadership the world of bevel gear cutting has converted to environmentally friendly, dry machining of gears with significantly increased power density due to non-linear machine motions and new processes. Those developments also lower noise emission level and reduce energy consumption.

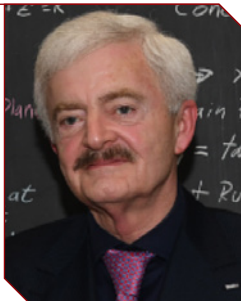

For 35 years, Dr. Stadtfeld has had a remarkable career within the field of bevel gear technology. Having received his Ph.D. with summa cum laude in 1987 at the Technical University in Aachen, Germany, he became the Head of Development & Engineering at Oerlikon-Bührle in Switzerland. He held a professor position at the Rochester Institute of Technology in Rochester, New York From 1992 to 1994. In 2000 as Vice President R&D he received in the name of The Gleason Works two Automotive Pace Awards — one for his high-speed dry cutting development and one for the successful development and implementation of the Universal Motion Concept (UMC). The UMC brought the conventional bevel gear geometry and its physical properties to a new level. In 2015, the Rochester Intellectual property Law Association elected Dr. Stadtfeld the “Distinguished Inventor of the Year.” Between 2015–2016 CNN featured him as “Tech Hero” on a Website dedicated to technical innovators for his accomplishments regarding environmentally friendly gear manufacturing and technical advancements in gear efficiency.

Stadtfeld continues, along with his senior management position at Gleason Corporation, to mentor and advise graduate level Gleason employees, and he supervises Gleason-sponsored Master Thesis programs as professor of the Technical University of Ilmenau — thus helping to shape and ensure the future of gear technology.

For Related Articles Search

differentials 

at www.geartechnology.com

Call for Papers!

Were you scheduled to present a gear-related technical paper at an event that got canceled this year?

Submit your work to ***Gear Technology*** instead!

We are always on the lookout for new technical authors. To have your work considered for inclusion in ***Gear Technology***, please submit your abstract to **Jack McGuinn, Senior Editor**, at mcguinn@agma.org.

Influence of Planet Carrier Misalignments on the Operational Behavior of Planetary Gearboxes

Prof. Dr.-Ing. Christian Brecher, Dr.-Ing. Dipl.-Wirt.-Ing. Christoph Löpenhaus and Julian Theling M.Sc.

Introduction and Motivation

The measurement results as well as the analysis of the present paper have been generated in the context of a project funded by the Federal Ministry of Economic Affairs and Energy (BMWi) with the title “Loads on the drive components of wind turbines” (FKZ 0325799). The main objective of the project is the further improvement of the validity of today’s simulation models by means of the first large-scale validation by means of a wind turbine. In the long term, this should enable the systematic optimization of the function and reliability of the electromechanical drive-train of wind turbines (Ref. 2).

The test object is a 2.7 MW wind turbine modified in cooperation with the project partners, cf. (Fig. 1). It is driven via a 4 MW direct drive, which provides a maximum torque of 3.4 MNm starting at a rotational speed of 4rpm, thus eliminating the need for an additional gearbox on the input side. A non-torque load unit (NTL) is installed next to the drive motor. This enables the test nacelle to be loaded in the remaining five degrees of freedom. Thus, it is possible to simulate bending moments and forces of external wind loads and to apply them to the test drive train even in dynamic conditions. The gearbox has the same design and macro geometry as a Winergy wind turbine gearbox. The micro geometry of the gears was redesigned so that all geometry parameters of the gears are known (Ref. 3).

One sub objective of the project is to identify the influence of external loads caused by the wind-field and electrical grid on the loading of drive train components. External loads caused by different wind conditions result into bending moments and forces on the input shaft of the nacelle, which lead to deformations

and misalignments in the gearbox. The input forces and bending moments can be simulated aerodynamically and applied on the input shaft by means of the NTL.

In the test gearbox consisting out of a planetary gear stage and two cylindrical gear stages approximately 150 sensors are applied, in order to measure for example the misalignment and the effect of the misalignment on the component loading. Therefore, position sensors as well as strain gauges in the tooth root of the sun and ring gear are applied. Furthermore, the rotational position of every shaft as well as the deviation of the whole housing are measured.

loads resulting out of the radial, axial and tangential components of the gear mesh forces. Due to the trend towards higher power densities, the internal loads increase, while at the same time thinner and thus generally less stiff surrounding structures are used (Ref. 9). As a result, higher deformations and thus also higher shaft misalignments are to be expected in the future.

Shaft misalignments always occur when the rotary axes of one or more gears deviate from the ideal position e.g. due to deformation or assembly tolerances, cf. (Fig. 2). A distinction can be made between parallel displacements of the axes, which result in a center distance deviation and angular misalignments. Regarding involute gears, the effect of angular misalignments is typically more important. Angular misalignments can be distinguished in terms of inclination and skew. An axis skew corresponds to a rotation of the axis in relation to each other about the axes connecting line. An axis inclination exists when the axes of the gears are rotated in the plane defined by those axes in misaligned condition

Shaft Misalignments in Cylindrical and Planetary Gearboxes

Similar to cylindrical gears, shaft misalignments in planetary gearboxes result amongst other influences from manufacturing tolerances and load-dependent deformations of the shaft-bearing system. The loads that lead to this deformation can be either external loads from surrounding elements or internal

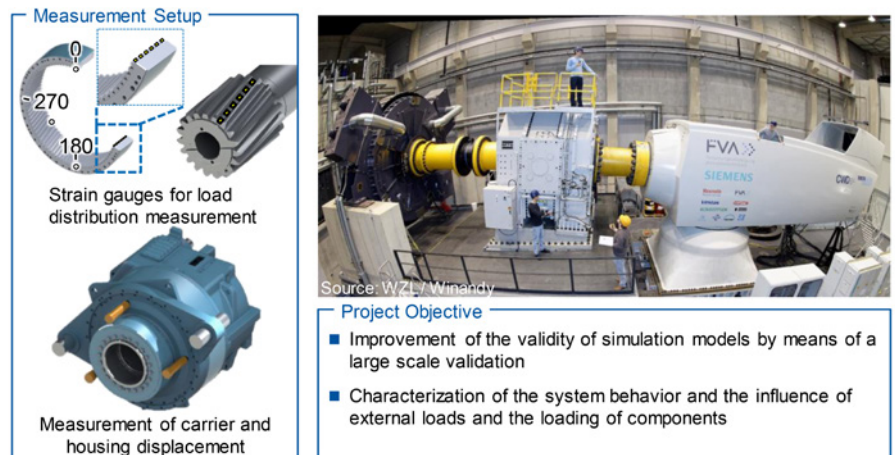

Figure 1 Test setup and objective.

© WZL

and thus intersect each other. According to Wittke, both components of angular misalignments can be summed up into a resulting lead angle deviation $f_{H\beta}$ (Ref. 16). The lead angle deviation can be calculated by means of the pressure angle at the operating pitch diameter α_{wt} as well as the inclination or skew angle (Ref. 16).

The misalignments occurring with cylindrical gears can in principle be transferred to planetary gears. Due to the existing kinematics and the loads of the individual elements, other types of misalignment can occur which can also have different local effects on the gear mesh (Ref. 11).

Simple planetary gearboxes consist of the central elements sun gear, ring gear and planet carrier, as well as usually three or more planets (Fig. 2). Due to the arrangement, each gear has several meshes. The load on the surroundings, i.e. — the shafts, bearings and carriers, results from the superposition of the gear loads from the individual meshes. The sun gear is often mounted in an adjustable manner via a spline-tooth coupling or spherical roller bearing in order to find an ideal position for itself on the basis of the individual force components. The aim is to transfer the load as evenly as possible to all planets. A displacement is therefore intended and desired at the sun wheel (Ref. 1). Ring gears are mainly designed as housing elements; misalignment of the ring gear is therefore strongly dependent on the misalignment of the housing (Ref. 13).

The planet gear is in contact with the ring and sun gear. The tangential tooth forces of the planet point in the same direction due to the flank change and have the same magnitude due to the torque compensation and the equal base diameter. In the case of helical gears, in addition to radial and tangential forces, axial forces also occur. In the ring gear mesh and sun gear mesh of the planet, the axial forces are directed in the opposite direction and balance each other out. The force acting points of the two meshes are located in different areas of the planet, as a result of which an axial bending moment is applied. This must be balanced by the planet bearing and the planet pin.

The planet carrier has a significant influence on the deformation within planetary gearboxes. The tangential

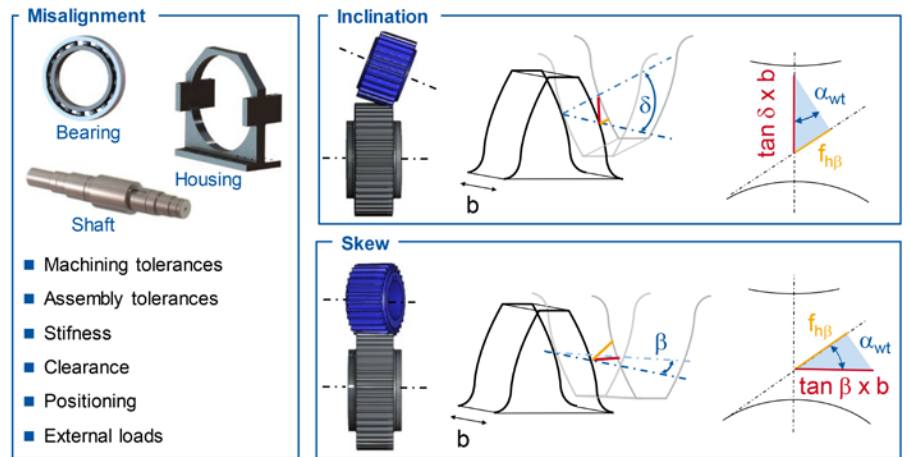

Figure 2 Shaft misalignments in cylindrical gears.

© WZL

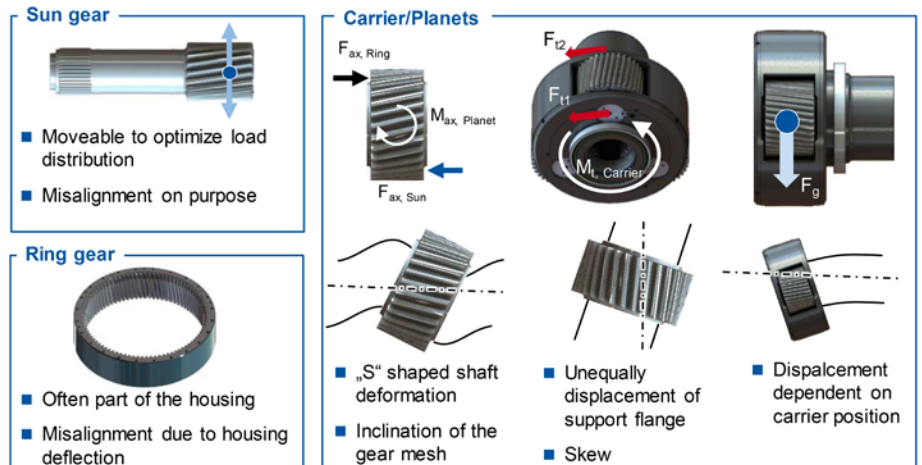

Figure 3 Misalignments in planetary gear stages.

© WZL

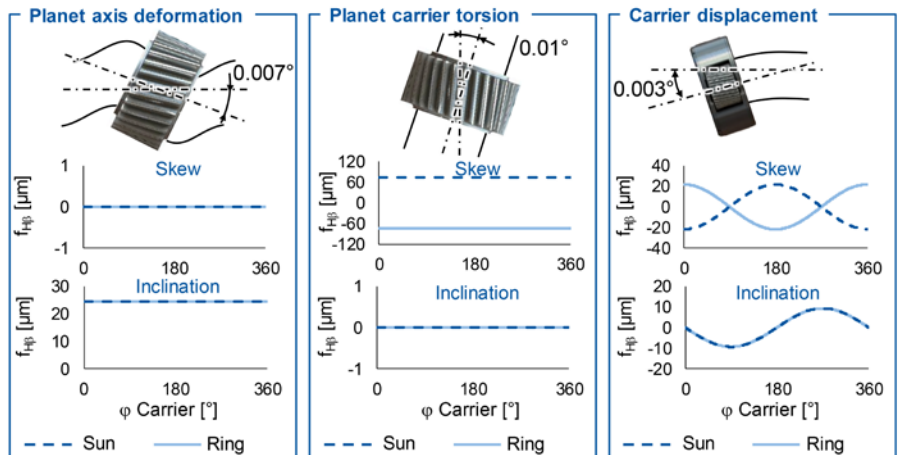

Figure 4 Effect of misalignments on the gear mesh conditions.

© WZL

forces of the individual planetary gears are supported at the carrier and thus generate the carrier torque (Ref. 15). Due to the one-sided torque transmission at the carrier shaft, the torsional moment varies in magnitude over the face width. Furthermore, the carrier wall facing away from the carrier shaft has a lower torsional stiffness due to the bar-shaped

connection. The effect is a twisting of the two carrier walls in relation to each other and thus a misalignment of the planet shaft mounted in the carrier walls. Like the planets, the carrier is free of radial and axial forces. An additional displacement of the carrier caused by mesh forces is therefore unlikely. External loads such as the weight force or forces acting from

connecting components of the carrier shaft, such as rotors in wind turbines, are therefore the main cause of misalignment. Other influencing factors are bearing clearance and tolerances as well as manufacturing and assembly deviations.

In Figure 4 the effect of the different misalignments on the resulting lead angle deviation and therefore meshing conditions is presented. Therefore, tolerances of the shaft-hub connections are analyzed and transformed into a resulting lead angle deviation according to Wittke (Ref. 16). The selected displacements represent the characteristic displacements of planetary gears: “S-Shape” due to the bending moment of the axial forces on the planet; planetary displacements due to different twisting of the carrier walls and a misalignment of the carrier due to external loads or misalignment of the housing.

The planetary axis misalignment due to axial forces of the planet causes a pure inclination of the planet, since the axis of rotation of the tilting is perpendicular to the axis connection line of sun and planet (Fig. 4); the carrier position shows no influence.

A similar effect is caused by the planetary displacement due to a different twisting of the carrier walls. The displacement takes place in the tangential direction. In contrast to the planetary axis misalignment, a pure skew is present; there is also no dependence on the carrier position. Due to the mathematical transformation of the angular misalignment on the gear mesh via the sine of the pressure angle at inclination and the cosine at skew, the skew has a bigger influence for the same angular misalignment.

Carrier misalignments result in a component of inclination and skew. The

inclination and skew curves are phase-shifted by exactly a quarter rotation of the carrier. Due to the different influence of inclination and skew on the gear mesh, the resulting lead angle deviation is not constant. Planet carrier misalignments are comparable to a wobble in cylindrical gears. The amplitude of the lead angle deviation depends on the rotation angle of the carrier. For the carrier positions 90° and 270°, there are only inclination effects — for 0° or 360° and 180° only skew.

Objective and Approach

The objective of this report is to describe the effects caused by misalignments in planetary gearboxes and take them into account during the optimization and design process. Therefore, measurement data of the FVA nacelle has to be evaluated with respect to misalignments and their influence on the loading of the gears. In order to achieve a balanced design, both the load on the tooth flanks and the excitation behavior have to be included in the design process. In order to achieve the objective, four sub-objectives have to be fulfilled (Fig. 5.)

In order to regard the misalignments in the tooth contact analysis, the FE-based tooth contact analysis *FE-Stirnradkette* is extended in order to depict a complete tooth hunt of a planetary gear stage and take into account time-variable misalignments. This is necessary because the effect of a carrier misalignment has different influences on the mesh, depending on the current position. The extension is validated afterwards by a comparison between the calculated tooth bending stress and the measured stresses.

To evaluate the excitation behavior, the transmission error of a complete

tooth hunt is calculated as a sequence of individual pitches. The resulting time signal is transferred to the frequency domain and the effects are analyzed. Subsequently, a method to calculate local damage is developed, which considers the variable mesh positions in combination with the angular positions of the elements in planetary gearboxes.

At the end, the tooth flank has to be optimized in order to achieve less damage and a lower noise excitation with the aid of derived characteristic values. Therefore, an approach is used which is based on characteristic values derived in the first work packages that are input variables of a variant calculation carried out with the *FE-Stirnradkette* in combination with the statistical evaluation software *μOpt* to ensure a balanced and robust design against additional misalignments.

The input stage of the wind turbine gearbox of the FVA nacelle is selected as the application case for investigating the influence of misalignments in planetary gear stages. Besides the fact that the geometry is known, a further reason for the choice of the demonstrator is the existence of numerous test results. In particular, the misalignments of the planet carrier in relation to the housing are known for numerous load situations with loads in all six degrees of freedom. Selected test points together with the corresponding measured carrier misalignment represent the investigated operating points.

Description of Contact Conditions in Misaligned Planetary Gearboxes

The first sub-objective is the description of the contact conditions for misaligned planetary gearboxes. First, a method is developed which converts the shaft misalignment to the mesh according to the Wittke method as shown (Fig. 4) (Ref. 16). A main challenge is the consideration of the position-dependent carrier misalignment. The mesh specification is then used as input for the FE-based tooth contact analysis. Subsequently, measurement results of the FVA nacelle are presented and essential effects are described. The measurement is then compared to the simulation to validate the method.

Extension of the FE-Stirnradkette. In the following section, a method is

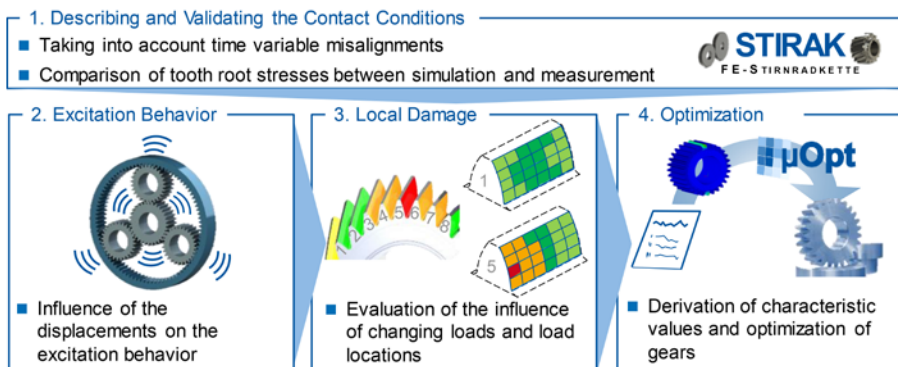

Figure 5 Objective and approach.

© WZL

discussed to consider misalignments of the planet carrier and the planets in tooth contact (Fig. 7). The calculation of the displacements from internal or external additional forces can be carried out in advance analytically or with the aid of finite element analyses. The method then takes these misalignments into account in the tooth contact analysis and can thus be used to analyze the influence of the respective deviations or for modification design; the method consists of four essential elements.

First, the displacements of the individual shafts are determined in a preceding calculation step. It is possible to use FE calculations or analytical approaches, as well as misalignments acquired by measurement. The input is made via the displacement of the bearing positions. From these, the vectors of the shafts are determined in a common coordinate system for all wheels.

Mathematical operations are used to transform the vectors for each mesh position of a complete tooth hunt on to the tooth contact. For this purpose, the state of the art methods for the transformation of inclination and skew are extended by the kinematics of planetary gears (Ref. 16). The results of this transformation are resultant $f_{H\beta}$ curves for the sun-planet and ring gear-planet mesh.

The resulting curves serve as input variables for the FE Spur Gear Chain \rightarrow FE-Stirnradkette. Deviations from the ideal tooth contact are considered as contact distances in the spring model; a new FE calculation is therefore not necessary, which leads to an optimization of the calculation time and quick evaluation of the results. Loads of the individual gears are determined for each meshing position of a complete tooth hunt. The results of the tooth contact analysis can be post-processed afterwards.

Measurement results of the FVA nacelle. The planet carrier is connected to the rotor of the wind turbine and supported by a main bearing (Fig. 6). The gear housing, in which the remaining gears are mounted, is supported by two flexible mounting points on the torque arm of the main frame. This mounting of the housing enables a tilting of the gear housing due to the weight force in comparison to the planet carrier (Ref. 15).

Due to this effect, there is a

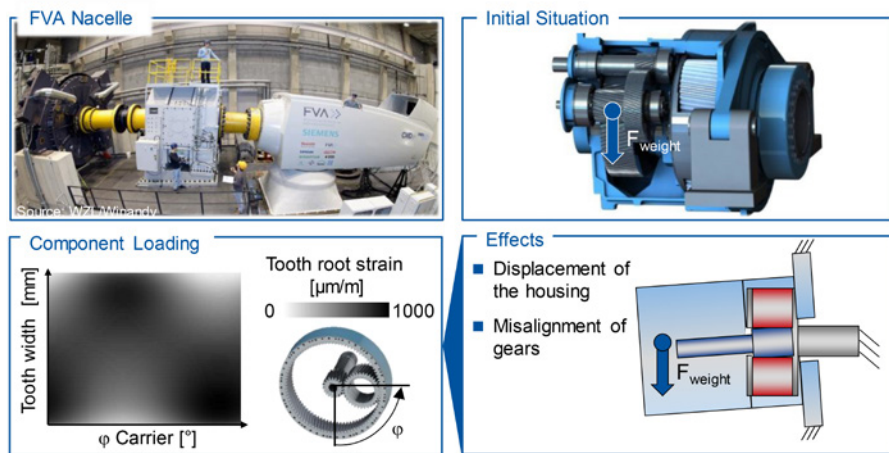

Figure 6 Test setup and occurring effects.

© WZL

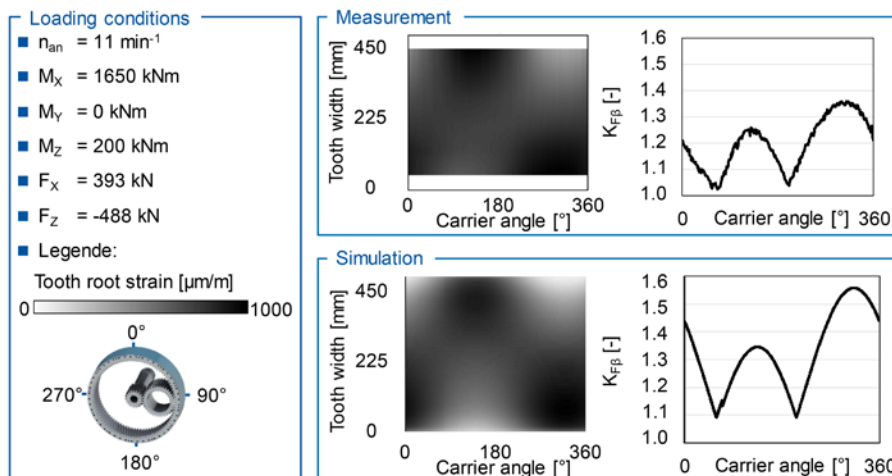

Figure 7 Validation of the simulation method.

© WZL

misalignment of the planet carrier with respect to the sun and ring gear. The loads on the sun gear are measured in the test gearbox via strain gauges in the tooth root. With the help of the rotation angle measuring systems, the current position of the gears can be determined in a post-processing and thereby at which carrier position the loads occur. The results show that the load distribution varies over the carrier angle due to the misaligned position. This can lead to significant overloads in the tooth contact.

The highest stresses occur in the tooth root if the meshing takes place at an upper 180° or lower position $0^\circ/360^\circ$. Between these two positions the location of the maximum stress also changes from the right to the left flank side of the sun gear. The lowest loads and the best load distribution are at the horizontal positions at 90° and 270° , respectively.

Because of the dependence of the contact conditions on the carrier position,

the same contact conditions always occur at the fixed ring gear on one tooth, so that this tooth always experiences the same load. On the sun and planet gear, however, the angular position at which a tooth comes into contact varies. This means that every contact position occurs on every tooth during a complete tooth hunt and the tooth load is time-variable. This finally results in internal load spectra already at constant external loads and displacements due to changed contact conditions.

Validation of the extension. In the following section, the calculation approach for the consideration of the carrier misalignments in the tooth contact analysis is validated. Measurement results of the FVA nacelle are used and compared with the results of the simulation method. The tooth root stress of the sun gear and the load distribution factor $K_{F\beta}$ for each position are used as evaluation variables. The load case corresponds to the nominal

torque of the system with $M_x = 1,650 \text{ kNm}$ at an average speed of $n_{in} = 11 \text{ rpm}$. Further loads applied to the shaft simulate, on the one hand, the rotor weight of the turbine in the direction of F_z and, on the other hand, bending moments and transverse forces from inclined wind flows on the rotor.

The misalignment of the planet carrier measured by distance sensors is used as the input variable of the method. The effects from the planetary axis are not considered in this example, since the influence of these displacements is small compared to the carrier displacement. The maximum values of the resulting $f_{H\beta}$ from the measured misalignment in the sun mesh are $\Delta f_{H\beta} = \pm 80 \text{ }\mu\text{m}$; Figure 7 shows the comparison of measurement and simulation.

The measurement results in the load case evaluated here show a clear dependence of the load distribution and the locally occurring tooth root stresses on the current carrier position. As explained previously, the maxima of the load distribution are located at approximately 0° or 360° and 180° . This corresponds to a mesh position in the upper and lower area of the ring gear. The highest load occurs in the tooth mesh in the 0° range. Between the two maxima, a change of the more heavily loaded flank side can also be seen. In the measurement, the width load distribution factor in the tooth root $K_{F\beta}$ shows values between $K_{F\beta} = 1.03$ and $K_{F\beta} = 1.38$, depending on the meshing position. The maximum at approx. 180° has a $K_{F\beta} = 1.25$.

The progression of the tooth root stresses can be correctly predicted with the method — both in width direction

and in dependence of the carrier angle. The amplitudes of the stresses are in the same range as in the measurement, and also the location of the maximum load is identical. When comparing the width load factor $K_{F\beta}$ between simulation and measurement, identical characteristics can be determined. Both graphs show maxima at 0° and 180° . The $K_{F\beta}$ of the maximum at 180° in the simulation is at $K_{F\beta} = 1.35$ and represents the load occurring in the measurement well. The second maximum is displayed higher in the simulation. The reason for this is on the one hand, the extended evaluation range in the simulation, because in the measurement, the results cannot be resolved up to the edge area, since no strain gauges were applied there. On the other hand, the differences can be explained by the lack of consideration of the flexible planet shaft, which can reduce the tilting due to the present clearance.

Calculation of the Transmission Error of Misaligned Planetary Gearboxes

The approach for calculating the transmission error of misaligned planetary gears uses the results provided by the previous developed and validated method. As input variable of the tooth contact analysis, one load case with measured misalignments is used. In the further investigations only planet carrier misalignments are taken into account during the investigations, because all other misalignments have a position invariable influence and could be optimized afterwards by lead angle modifications (Fig. 4). The misalignments of the carrier are transformed to the individual

meshing planes of each single pitch within one complete tooth hunt using the Wittke method as a function of angular carrier position (Ref. 16).

The result of the tooth contact analysis is the transmission error for one pitch for each angular position. The calculation is carried out separately for the sun and ring gear mesh without consideration of cross influences between those. The results of the individual single pitch calculations are combined into an overall signal in chronologically correct sequence. A consideration of differences in the length of a pitch is that premature and post-mature gear meshes or gear clamps do not take place. The evaluation of the signal is done in frequency domain on the basis of the speed-dependent orders. For this a fast Fourier transform (FFT) of the time signal is carried out. The evaluation takes place individually for each load case.

Figure 8 shows the results of the analysis for a load case at nominal load with a carrier misalignment resulting in an $f_{H\beta}$ deviation of $\Delta f_{H\beta} = 144 \text{ }\mu\text{m}$, compared to a simulation without carrier displacement. Considering a variable displacement, it can be seen that the rotational orders of the carrier are excited in the sun as well as in the ring gear. On the other hand, sidebands appear around the gear mesh orders. In the ring gear mesh a reduction of the amplitude of the first gear mesh order in comparison to the non-displaced variant is noticeable. The amplitude remains almost unchanged in the sun mesh.

Due to the low speeds of the carrier, the resulting excitations caused by the carrier rotation orders lie in the range below a frequency of $f = 1 \text{ Hz}$ and thus are not in the audible range of the human being. An excitation of these frequencies is nevertheless to be reduced, since tower natural frequencies are excited by the low-frequency vibrations of the transmission, which can lead to a swinging up of the turbine on the tower (Ref. 12).

The changed characteristics of the gear mesh orders can be explained mainly by modulation effects. Low-frequency, superimposed oscillations of the rotational orders lead to modulations and thus to the development of sidebands of higher-frequency oscillations of the gear meshes (Ref. 8). The formation of

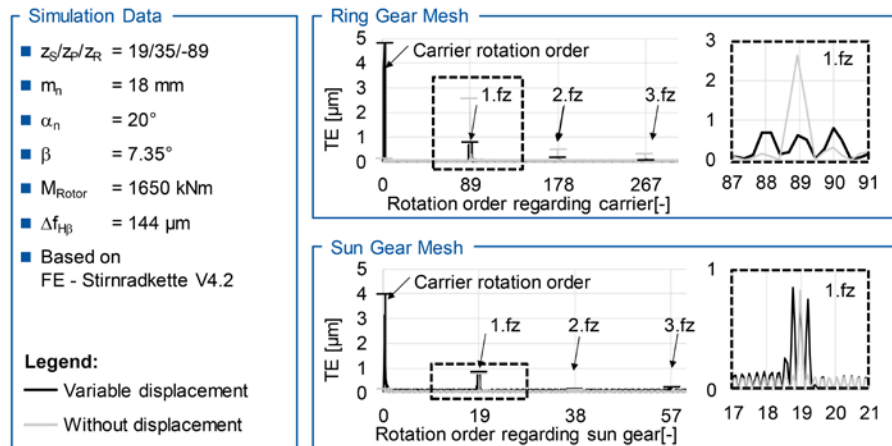

Figure 8 Results of the excitation behavior calculation with and without misalignments. © WZL

sidebands is often aimed for in order to reduce tonalities in the system. In this case, the amplitudes of the sidebands in the sun mesh exceed both, the first order of gear mesh and the amplitude of the undisplaced variant, so that the excitations of the system are amplified.

Influence of Planet Carrier Misalignments on the Load Carrying Capacity

A local accumulation of damage is used to assess the influence of moving contact patterns due to misaligned central elements in planetary gears. The method is similar to the Sfar and Ziegler method, but does not only consider the lower single contact point, but also the complete tooth flank (Refs. 13 and 17). The main difference to the existing methods is the consideration of internal load spectra resulting from shifted central elements with the help of the calculation of a complete tooth hunt. For the load calculation, a method for the analysis of the tooth contact with misaligned central elements developed and validated in the previous section is used. The load capacity is represented by an S/N curve, and sliding velocities are currently not taken into account. In the second part of this section, a comparison of the load carrying capacity of the tooth flanks is carried out with variable, constant and none displaced contact patterns for a load spectra in order to identify the influence of variable misalignments on local damage. Measured displacements of the FVA nacelle are used.

Approach to determine local damage. The previously developed method is extended in the present section so that the determined data can be post-processed in order to calculate the local damage of the tooth flank. In addition, the possibility to consider different external drive torques and misalignments via a load spectra specification is made possible.

In a first step, operating points “v” or load bins are specified (Fig. 9, bottom-left). In addition to the drive torque and the percentage of a load bin in the total number of load cycles, the displacement of individual gear elements is another input variable. Possible specifications are, for example, misalignments of the planet carrier, the ring gear or the planet

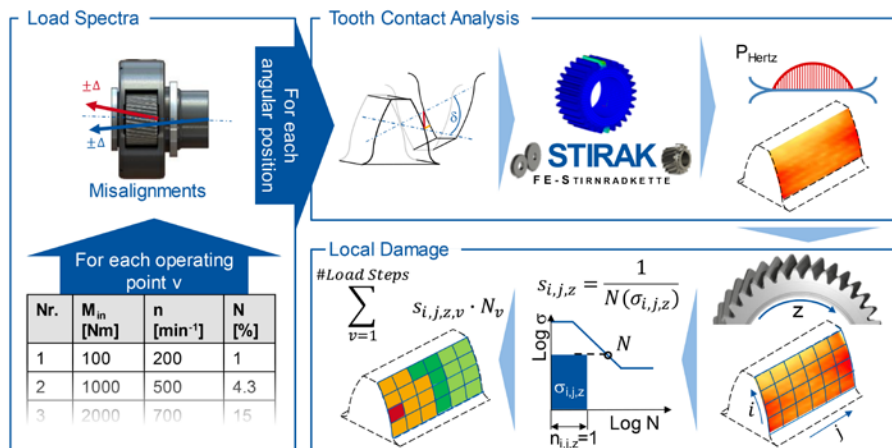

Figure 9 Approach for local damage accumulation.

© WZL

Table 1: Overview of regarded load bins						
Nr.	Mx [kNm]	My [kNm]	Mz [kNm]	Carrier angle [°]	Load Cycles [%]	
1	304	0	0	0.0277	10	
2	639	0	0	0.0157	5	
3	973	0	0	0.0187	20	
4	1312	0	0	0.0170	30	
5	1650	0	0	0.0204	20	
6	1650	1000	0	0.0065	7	
7	1650	-1000	0	0.0157	8	

in relation to the sun gear.

The contact conditions as well as the torque are used individually for each tooth pitch as input data of the FE-based tooth contact analysis *FE-Stirnradkette*. As a result of the tooth contact analysis, the tooth flank pressures according to Hertz are used for the further calculation. The tooth root load capacity is not examined in this report. For this purpose the tooth root stresses would be evaluated instead of the Hertzian pressure and a local accumulation of damage in the tooth root would be carried out.

In order to assess the local damage, the tooth in contact z corresponding to the angular position of the gear elements is identified at each gear for each single pitch. Each tooth is additionally rastered in i rectangular elements along the height and j elements in width direction. For each area of the grid, the maximum pressure is determined when one pitch is rolled over. The occurring flank pressure $\sigma_{i,j,z}$ of each element is the input variable for the evaluation of the individual damage. An S/N curve is used to determine the bearable number of load cycles $N_{i,j,z}$ for the determined pressure $\sigma_{i,j,z}$. The partial damage $s_{i,j,z}$ of an element due to one load cycle is defined as the reciprocal of the bearable number of cycles $N_{i,j,z}$

(Fig. 9, bottom-center).

For each load bin “v”, a complete tooth hunt is simulated so that all angular positions of the gear elements relative to each other are regarded. This means that several pitches are rolled over and all teeth are in contact several times. A partial damage by an additional contact is added to the already existing damage, so that finally a partial damage of all teeth and all flank elements for a complete tooth hunt of one load bin exists. This value is then divided by the number of pitches calculated for a complete tooth hunt and multiplied by the absolute number of cycles N_v of the load bin. The result is a total damage caused by the individual load bin. It should be noted here that the number of load cycles at the sun gear and ring gear must be multiplied by the number of planets, since the individual flanks are over-rolled several times. The results of the individual load bins are summed up so that a total damage of the individual flank elements results, taking into account the load spectra and corresponding measured misalignments.

Results of the evaluation of local damage. Selected test points together with the corresponding measured carrier misalignment represent the load bins of the investigated load spectrum. This leads

to plausible combinations of torques and misalignments. The internal load spectra result from the carrier displacement. The distribution of the number of load cycles among the respective collective classes does not correspond to reality, but is distributed in such a way that a large part of the operation takes place at nominal torque. An overview of the input data used can be found in Table 1. All operating points show a constant weight force of the rotor in z direction of $F_z = -488$ kN, a loading with axial and bending forces F_x and F_y does not occur.

In addition to the loads resulting from the operating conditions, the strength of the material is a necessary input variable for describing the local damage. The material behavior is described by an S/N curve (Fig. 10). The corresponding values for the sun and planetary gears are determined for case-hardened gears from ISO 6336 Part 5 for the material quality MQ (Ref. 5). Values for wrought alloyed material are used for the material behavior

of the ring gear. The durable permissible flank pressure of the case-hardened gears is $\sigma_H = 1,300$ MPa, of the ring gear $\sigma_H = 520$ MPa (Fig. 10, top-center). The consideration of carrier misalignment in the damage accumulation on the flank is carried out in three different ways. In the first variant, as described previously, the misalignment is calculated for each gear mesh on the basis of the angular position of the elements (variable misalignment). In the second variant the misalignment of the carrier is not considered (no misalignment), and in the third variant the maximum occurring value is assumed for all positions (maximum misalignment).

The pressures on the tooth flank calculated from the tooth contact analysis do not correspond to the standard value of the flank pressure σ_H , since application factors are not taken into account. In addition, the load spectrum does not correspond to reality, so that a calculation of the absolute damage value is not conducive. However, a relative comparison of

the calculated local damage between individual flank areas or designs is legitimate. Therefore, a normalized damage value \bar{S}_Z is used. This value is defined as the ratio of the maximum damage per tooth $S_{max,lok,z}$ to the maximum damage of a gear $S_{max,lok,var}$ in the calculation with variable displacement.

The upper-right part of Figure 10 shows the results of the local damage accumulation for the planet gear in the sun mesh. It can be seen that the normalized damage assumes a constant value of $\bar{S}_Z = 1$ for all teeth on the planet gear despite variable misalignment is regarded. The same behavior is observed at the sun gear. At the ring gear, however, different damages occur, depending on the tooth position. Here the tooth at the seventh position is most damaged. The graph shows a maximum at this point, a second local maximum with lower amplitude occurs with 180° offset at tooth 51. The results for the planet gear flank, which is in contact with the ring gear, are not displayed. The pressures occurring are all below the fatigue strength level because of the concave-convex contact, so that no damage can be determined.

The constant damage to the sun and planet gears can be explained by the rotation of the two gears. Each tooth of the sun gear, as well as of the planet gear, does not have a fixed global mesh position; the global position depends on the actual carrier position. The deviations of the gear mesh resulting from the misalignment of the carrier are also dependent on the carrier position; therefore, temporally variable deviations occur at one tooth of the sun and planet gear. After a complete tooth hunt of the planetary gear stage, each tooth of the sun and planet gear are exposed to the same positions and thus to the same loads. Due to the fixed positioning in a load bin, a tooth on the ring gear always has identical mesh conditions. Therefore, the degree of damage changes depending on the tooth position. The second local maximum is smaller, since areas of the tooth flank are stressed in which the supporting effect of the helix angle is missing. As a result, the flank can be deformed better and the pressure values are lower.

The diagrams also show the results of the local accumulation of damage without and with maximum displacement

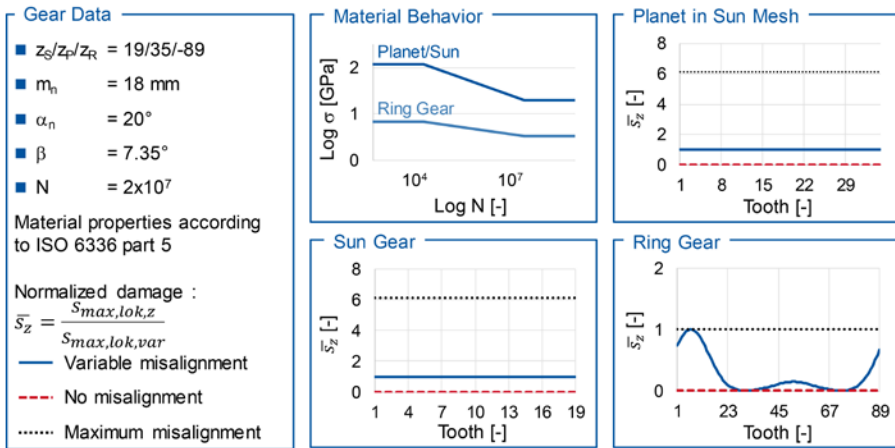

Figure 10 Results of the local damage accumulation.

© WZL

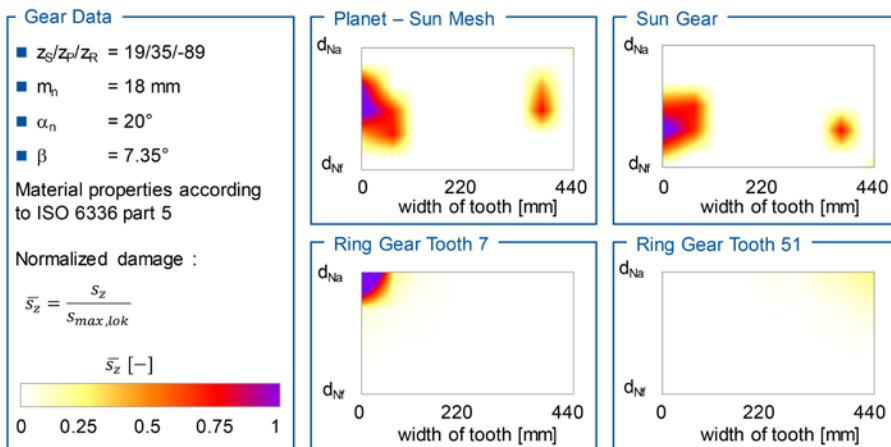

Figure 11 Analysis of the location of local damages.

© WZL

(Fig. 10). The locally determined maximum damage with variable displacement was kept as the reference value. It can be determined that no damage to the tooth flanks occurs in a calculation without misalignment. All pressures are below the fatigue strength of the material and are not relevant for damage. If the maximum misalignment is used to assess the damage, the same maximum value is obtained for the ring gear as for the local evaluation. The damage to the sun and planet gear is six times higher than in the local calculation. A dimensioning of the gears with the maximum value of the misalignment would thus be safe, but at the same time clearly over-dimensioned. A dimensioning without consideration of the influence of the variable effects over the circumference, however, leads to under-dimensioned gears.

In Figure 11, the damage values are plotted on the maximum loaded tooth flanks. It can be seen that the damaged areas on all gears are extremely localized. On the planet and sun gear, damaged areas occur on the left and right side of each tooth flank. Here, the left side of the tooth is stressed more than the right side of the flank. The damage to the ring gear depends on the position of the tooth on the circumference; the highest damage is determined at tooth 7. This occurs locally in the tip area on the left side of the flank. At the second local maximum at tooth 51, the right area of the tooth flank is subjected to greater stress. Here, too, the highest damage is found in the tip area, but it is significantly lower than on tip seven.

Due to positive slip, the head areas are generally less relevant to flank damage than high loads in the negative slip area, but nevertheless the local limitation of the damage shows that the flank is used sub-optimally. A uniform damage over the entire flank would correspond to an ideal geometry where all points of the flank fail at the same time. The areas with the highest damage result from edge contact that cannot be robustly compensated by the gear geometry. In the ring gear contact, the maximum stress is located in the area of the upper single contact, since here the highest loads have to be transmitted by a pair of teeth. On the planetary flank there is a tip relief, which reduces the load on the second single meshing area. In sun contact, both single

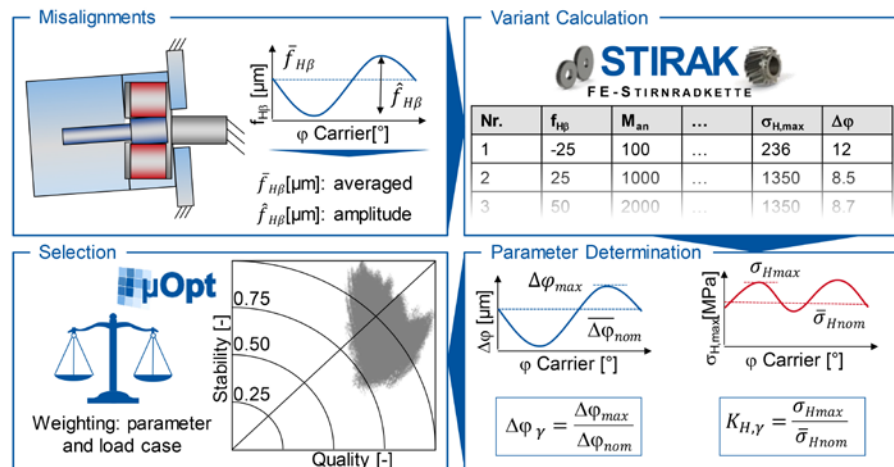

Figure 12 Approach of the design method.

© WZL

contact areas are relieved due to the tip relief provided on both flanks. This is why the maximum damage occurs in the double-contact area.

Optimization of the Operational Behavior of Planetary Gearboxes

The procedure explained here focuses on the design of the flank corrections of the planet. The optimization goal is to increase the robustness of the load carrying capacity against misalignments. In addition, the overall excitation should be reduced — especially in the low-frequency range. As input variables for the design, the averaged lead angle deviation $\bar{f}_{H\beta}$ over one carrier rotation as well as the amplitude of the variation of the lead angle deviation $\hat{f}_{H\beta}$ from maximum to minimum value are taken into account. The design is carried out with a variant calculation in the *FE-Stirnradkette* as well as a post-processing and a statistical evaluation of the results with the help of the *μOpt* program (Fig. 12).

The variant calculation is carried out separately for the individual meshes between sun and planetary gear, as well as ring gear and planetary gear. For this purpose the lead angle deviation is finely resolved over a wide variation range. Using the mean lead angle deviation $\bar{f}_{H\beta}$ and the amplitude of the lead angle deviation $\hat{f}_{H\beta}$ all possible deviations for one nominal design are determined in a post-processing. The individual results of the transmission error and the flank pressure are determined for each lead angle deviation occurring in the misalignment range in one load bin.

From the sum of the individual results, the value $K_{H,\gamma}$ is determined as the factor

of the load increase of the tooth flank over one rotation of the carrier and $\Delta\phi_\gamma$ as the deviation of the transmission error over one rotation of the carrier for each nominal design and each load step.

For this purpose, the maximum value of the rotational error $\Delta\phi_{max}$ and the flank pressure σ_{Hmax} is determined from all values occurring over one rotation of the carrier and divided by the value occurring for the average $\bar{f}_{H\beta}$. An additional boundary condition, which is added in the evaluation, is the symmetrical design of the flank corrections on both tooth flanks of the planet.

The maximum Hertzian pressure, the transmission error at the average misalignment as well as the two newly introduced load increase factors $K_{H,\gamma}$ and $\Delta\phi_\gamma$ are included as parameters in the evaluation of the variants. All values are determined for each nominal variant for the sun and ring gear mesh and then evaluated together. The evaluation takes place depending on the load case and the parameter with the help of the *μOpt* software. Here the load cases are weighted more strongly with increasing rotor torque and the pressure is evaluated higher than the transmission error. The overview of the individual variables is shown (Fig. 13).

The optimized flank geometry essentially differs from the nominal design by an applied profile angle correction and a higher lead crowning. Due to the positive profile angle correction at the planet, the tooth tip of the ring gear is relieved and the area of maximum load moves in the direction of the tooth center. The effect of the changed microgeometry becomes clear when comparing the results of local

damage accumulation before and after optimization. The damage values of the new design are determined and divided by the reference value. The reference value of the normalized damage is the value $s_{max,lok,origin}$ of the original variant.

In the sun mesh, a reduction of the damage can be achieved to a value of $X = 0.75$ — both at the planet and at the sun gear. The flank damage of the ring gear can be reduced to a value close to $S_z = 0$. The difference between the level of damage depending on the tooth position at the ring gear is also reduced. The reason for this is, on the one hand, the avoidance of edge contacts which have led to high loads in the edge area of the gear teeth. This resulted in high damage values in the original design. On the other hand, the contact pattern in the ring gear mesh moves in the direction of the flank center due to the profile angle correction, whereby locally high pressures in the tip area can be avoided.

Summary and Outlook

This study deals with the modeling and consideration of misalignments in planetary gearboxes in the optimization and design process. Procedures for taking into account misalignments in cylindrical gearboxes are standardized and established in industry. Misalignments of central elements like carrier, sun gear or ring gear in planetary gearboxes, cause-varying contact positions and variable loads, depending on the angular position of the central elements. This load, which is variable over the circumference, is not taken into account in the standardized procedures, despite its effects on the loads on the gears.

Within the scope of this report, a method is developed in order to regard carrier misalignments in the tooth contact analysis *FE-Stirnradkette*. Because of carrier position-dependent mesh conditions, a complete tooth hunt is calculated and post-processed afterwards. By means of a comparison between simulated and measured tooth root stresses of the FVA nacelle, a validation of the method is successfully carried out.

By means of the validated method, the influence of carrier misalignments on the load carrying capacity and

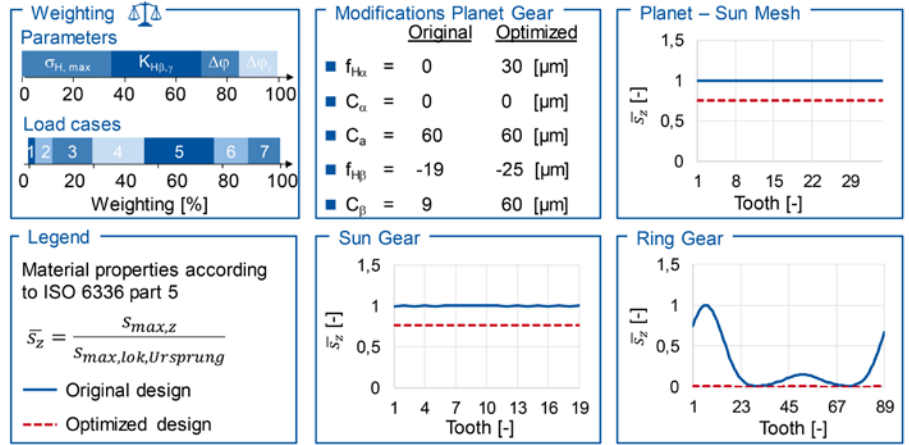

Figure 13 Influence of the optimization on the local damage.

© WZL

excitation behavior are determined. In a post-processing of the previously developed method, the transmission error of the single meshes, as well as the damage locally resolved on the tooth flank of each tooth of each gear, is calculated. The transmission error of misaligned and aligned planetary gearboxes differs. In misaligned conditions, sidebands of the tooth mesh frequencies occur. Furthermore, the carrier rotational frequency is excited.

The results of the local damage calculation show that due to the rotation of the sun and planet gear, changing meshing conditions are present on a tooth. In sum, each tooth on these wheels sees the same loads, resulting in homogeneous damage over the wheel. One tooth is always subjected to the same load on the fixed ring gear. This results in variable damage over the circumference, with some teeth being much more damaged than others. If the misalignment of the carrier is not taken into account, the wheels will not be damaged at all. If the maximum misalignment is assumed in all positions, too high damage is calculated, except for the ring gear.

The optimization is carried out via the flank corrections on the planetary gear. For this purpose the deviation range, as well as the mean value of the resulting lead angle deviation, are included in the calculation in order to take the misalignment of the carrier into account. New characteristic values are generated for the consideration of the load increase over the circumference K_{Hy} as well as the deviation range of the transmission error over the circumference $\Delta\phi_y$, and different

nominal designs are compared with the help of the μOpt software. The recalculation of the best variant shows a reduced damage of all flanks, despite a higher crowning. The effect of the varying damage over the ring gear circumference can almost be eliminated.

As a next step, slippage effects will be regarded during the local damage calculation to better predict the localization of failure. Also measurements will be done on a smaller test rig to validate the effects observed in the evaluation of the excitation behavior. Therefore, different distinct misaligned conditions can be set and the transmission error can be measured.

Power Transmission Engineering (FVA) for the software *FE-Stirnradkette*. The authors gratefully acknowledge support by the WZL Gear Research Circle for the software μOpt . The authors gratefully acknowledge financial support by the Federal Ministry for Economic Affairs and Energy (FKZ 0325799) for the achievement of the project results.

For more information.

Questions or comments regarding this paper? Contact Julian Theling at kj.theling@wzl.rwth-aachen.de.

References

1. Bastert, C.-C. "Die Verlagerung der Zentralräder in Planetengetrieben." In: Forsch Ing-Wes, 37. Jg., 1971, Nr. 1, S. 21–29.
2. Brecher, C., C. Löpenhaus and D. Piel. "Auslegung und Untersuchung eines Forschungsgetriebes für Windkraftanlagen mit der FE-basierten Zahnkontaktanalyse DMK," Dresden: TUD press, 2015.
3. Brecher, C., C. Löpenhaus, J. Theling, M. Schroers and D. Piel. "FE-Based Method for Design of Robust Tooth Flank Modifications for Cylindrical and Planetary Gear Stages Regarding Manufacturing Tolerances," *AGMA Fall Technical Meeting*, 2017.
4. Ingeli, J. "Erweiterung der FE-basierten Zahnkontaktanalyse zur normkonformen Grübchenträgfähigkeitsberechnung symmetrischer und asymmetrischer Verzahnungen," Dissertation IIF - Institut für Industriekommunikation und Fachmedien GmbH, 2017.
5. ISO 6336 Teil 5. (Juli 2003) Calculation of load capacity of spur and helical gears, Strength and Quality Materials.
6. ISO 6336 Teil 3. (September 2006) Calculation of load capacity of spur and helical gears, Calculation of Tooth Bending Strength.
7. ISO 6336 Teil 2. (September 2006) Calculation of load capacity of spur and helical gears, Calculation of Surface Durability (Pitting).
8. Landvogt, A. "Einfluss der Hartfeinbearbeitung und der Flankentopographieauslegung auf das Lauf- und Geräuschverhalten von Hypoidverzahnungen mit bogenförmiger Flankenlinie," Diss. RWTH Aachen University, 2003.
9. Lubenow, K., F. Schuhmann and S. Schemmert. *Requirements for Wind Turbine Gearboxes with Increased Torque Density with Special Attention to a Low-Noise Turbine Operation*, Conference for Wind Power Drives 2019, Norderstedt: Books on Demand, 2019.
10. Miner, M. "Cumulative Damage in Fatigue," *Journal of Applied Mechanics-Transactions of the ASME*, 12. Jg., 1945, Nr. 3, S. A159-A164.
11. Niemann, G. and H. Winter. *Maschinenelemente. Band 2: Getriebe allgemein, Zahnradgetriebe - Grundlagen, Stirnradgetriebe*. Bd. Nr. 2, 2. Aufl. Berlin: Springer, 2003.
12. Seidel, M. "Auslegung von Hybridtürmen für Windenergieanlagen - Lastermittlung und Nachweis der Ermüdungsfestigkeit am Beispiel einer 3,6-MW-WEA mit 100 m Rotordurchmesser," *Beton- und Stahlbetonbau*, 97. Jg., 2002, Nr. 11, S. 564–575.
13. Sfar, M. "Bestimmung von Verzahnungskorrekturen und Lagerkräften in Planetengetrieben für Lastkollektive," Diss. Ruhr-Universität Bochum, 2011.
14. Theling, J., C. Brecher and C. Löpenhaus. "Einfluss von Planetenträgerabweichungen auf die Lokale Lastverteilung in Planetengetrieben," KISSsoft AG (Hrsg.): SMK 2018. Dresden: TUD press, 2018.
15. Vriesen, J. "Berechnung der Verzahnungskorrekturen von Planetenradgetrieben unter Berücksichtigung der Steg- und Hohlradverformungen," Diss. Ruhr-Universität Bochum, 2001.
16. Wittke, W. "Beanspruchungsgerechte und Geräuschoptimierte Stirnradgetriebe Toleranzvorgaben und Flankenkorrekturen," Diss. RWTH Aachen University, 1994.
17. Ziegler, A. "Zur verkürzten Systemlebensdauerprüfung von Zahnradgetrieben," 1. Aufl. München: Verl. Dr. Hut, 2011.

Prof. Dr.-Ing. Christian Brecher has since January 2004 been Ordinary Professor for Machine Tools at the Laboratory for Machine Tools and Production Engineering (WZL) of the RWTH Aachen, as well as Director of the Department for Production Machines at the Fraunhofer Institute for Production Technology IPT. Upon finishing his academic studies in mechanical engineering, Brecher started his professional career first as a research assistant and later as team leader in the department for machine investigation and evaluation at the WZL. From 1999 to April 2001, he was responsible for the department of machine tools in his capacity as a Senior Engineer. After a short spell as a consultant in the aviation industry, Professor Brecher was appointed in August 2001 as the Director for Development at the DS Technologie Werkzeugmaschinenbau GmbH, Mönchengladbach, where he was responsible for construction and development until December 2003. Brecher has received numerous honors and awards, including the Springorum Commemorative Coin; the Borchers Medal of the RWTH Aachen; the Scholarship Award of the Association of German Tool Manufacturers (Verein Deutscher Werkzeugmaschinenfabriken VDW); and the Otto Kienzle Memorial Coin of the Scientific Society for Production Technology (Wissenschaftliche Gesellschaft für Produktionstechnik WGP).



Dr.-Ing. Dipl.-Wirt.-Ing. Christoph Löpenhaus has since 2014 served as Chief Engineer in the Gear Department of WZL, RWTH Aachen / Laboratory of Machine Tools and Production Engineering (WZL), RWTH Aachen. He previously held positions there as (2011–2014) Team Leader, Group Gear Testing Gear Department Chair of Machine Tools Laboratory of Machine Tools and Production Engineering (WZL) RWTH Aachen; (2010–2011) Research Assistant, Group Gear Testing Gear Department Chair of Machine Tools Laboratory of Machine Tools and Production Engineering (WZL) RWTH Aachen; (2007–2009) as Student Researcher, Group Gear Design and Manufacturing Calculation Gear Department Chair of Machine Tools Laboratory of Machine Tools and Production Engineering (WZL) RWTH Aachen; and (2004–2009) as a student in Industrial Engineering RWTH Aachen.



Since June 2019 **Julian Theling M.Sc.** has been the leader of the Gear Acoustics group at the Laboratory of Machine Tools and Production Engineering (WZL). He started his career as a researcher at the WZL in 2016 after receiving his master's degree in mechanical engineering from RWTH Aachen University. Theling's research focus is the influence of flexible surroundings on the application behavior of planetary gear stages.



For Related Articles Search

planetary gears

at www.geartechnology.com

Machine Tool Builders

ANNOUNCE PERSONNEL CHANGES AND NEW DISTRIBUTION AGREEMENT

Machine Tool Builders, Inc. (MTB) proudly announces the appointment of **Hans Grass** as the company's CEO. Grass brings a wealth of knowledge and experience backed by 48 years in the machine tool industry, including forty-four years in management roles — most recently (for 5 years) as vice president for the Star SU machine tool group and (10 years) as vice president of engineering (managing both engineering and product development) for Bourn & Koch in Rockford.



Prior positions included various management and sales/service positions with Pfauter, Gleason and Index Corporation. Hans has gained in-depth expertise of gear manufacturing machine tools as well as milling, turning, grinding and other machine tools. He was educated in Germany with a Pfauter machine tool apprenticeship program, complemented by three years of engineering studies.

Machine Tool Builders and Grass have teamed up to formally announce the transfer of G-Technologies North American representation agreement for HAMAI Machines, to Machine Tool Builders Inc. Following the appointment of Grass as CEO of Machine Tool Builders Inc., MTB has assumed the exclusive rights as North American distributor of Hamai's hobbing solutions line.

Established in 1921 Hamai Co., Ltd., Tokyo, Japan designs, manufactures, and services state-of-the-art N-series CNC horizontal hobbing machines & a GN150 hob sharpener. Having built a solid reputation in the small/medium gear manufacturing industries by supplying fine to medium pitch horizontal hobbing machines for nearly 100 years, Hamai has also earned

a solid reputation for their high accuracy, impeccable quality, and highly productive machine tools.

This was an ideal fit for Machine Tool Builders Inc. who was looking to expand their new product offerings and thrilled that Grass and G-technologies allowed them to take on the rights to this line. The transfer of this agreement appoints Machine Tool Builders (MTB) as the exclusive sales, marketing, and support arm for all Hamai's gear hobbing solutions in North America.

When Grass was appointed CEO of Machine Tool Builders Inc. (MTB) he brought with him more than 40 years of expertise in the machine tool industry, his company G-technologies also held an exclusive representation agreement for North America representing Hamai.

"We are delighted to bring the Hamai line to MTB and offer comprehensive gear manufacturing solutions to our customers" notes Grass, president of G-Technologies and CEO of Machine Tool Builders Inc. "MTB's representation



agreement with Hamai is a perfect fit, this partnership will allow us to further improve our rapidly growing position in the market by offering high-value products and services that meet our customer's ever changing needs."

MTB issued a statement saying, "We thank Hans Grass and G-technologies for laying the groundwork of Hamai's presence in North America, this provides our customers with another world-class product backed by the MTB name." (www.machinetoolbuilders.com)

Global Gear

APPOINTS NEW PRESIDENT

Harshad Gujarathi has been named president of Global Gear of Downers Grove, IL, effective June 1. Gujarathi will take over for Cory Ooyen, the outgoing president, who remains with the company in a sales management role.

Gujarathi rejoined Global Gear in March 2020 as vice president of operations, after six years at Reliance Gear in Elmhurst, IL. At Reliance, Gujarathi served in a number of roles, including project manager, plant manager, operations manager and, most recently, managing director (from 2017 until his return to Global Gear in March). Previously, Gujarathi worked for six years as a



manufacturing applications engineer at Global Gear and four years as a senior engineer at Jayna Inc. He holds a bachelor's degree in mechanical engineering from Sanjeevani Education Society's College of Engineering, as well as a master's degree in industrial and systems engineering from The Ohio State University.

The move is part of a planned transition. In a letter to Global Gear employees, Ooyen stated: "Since the end of 2018 we have started the planning process for the transition of key staffing at Global Gear to support near term retirement plans and put in place a future team for the next many years of the company."

Ooyen continued, "That plan included the recruitment of my successor to insure the right leader was in place and the transition would be smooth, seamless, yet ready for the changes and challenges that Global Gear will face now and in the future.

So with that, I am pleased to announce that effective June 1st, Harshad Gujarathi will take over as President of Global Gear. His past experiences at Global Gear and at Reliance Gear support his desire and ability to assume this role and lead the company. I firmly believe Harshad is the right person to lead and direct these efforts. He needs the team with him to prepare for these challenges at all levels of the company. I will move fully into a sales role to expand our customer and market base and secure the future business to provide growth and future opportunities for all. In the 13 years I have been in the president's role, I can say we have made some tremendous strides in diversification of the business in both customers and markets. I thank all who have supported and played key roles in these efforts. This would not have happened without a crew who dedicated their time and efforts into moving Global Gear from a simple engine timing gear company to a respected and diverse gear supplier to a broad range of applications."

(www.globalgearllc.com)

EMAG

OPENS ADDITIONAL OFFICE IN CHARLOTTE

EMAG has expanded its operation in the United States by opening an additional office, EMAG Charlotte, in Charlotte, NC. With this addition, current and prospective customers located in the southeastern portion of the United States have the ability to meet face to face with sales, applications and service personnel. By providing local support, EMAG strives to foster the growth that the industry is experiencing throughout the region.



EMAG Charlotte will operate as a branch office of EMAG LLC, located in Farmington Hills, Michigan, the North American Headquarters for the EMAG Group.

With the growth of EMAG's competitive Modular Standard machine portfolio, accessibility to new users has grown substantially; the Southeast is one of the fastest growing manufacturing hubs in the United States, driving EMAG's strategic decision to open EMAG Charlotte.

The unique configuration of EMAG's turning machine, allows for the automatic self-loading of workpieces. The inverted, traveling spindle architecture creates an ideal environment for cleanliness, optimum chip flow, and unsurpassed

BEYTA GEAR SERVICE 

PUTTING
A LIFETIME

OF

GEAR
DESIGN

EXPERIENCE

TO WORK FOR YOU

- Reverse engineering
- Gearbox upgrades
- Custom gearbox design
- Specification development
- Project management
- Vendor qualification
- Design reviews
- Bid evaluations
- Tooling design
- Customized gear training
- Equipment evaluation
- Custom machine design

Charles D. Schultz
chuck@beytagear.com
[630] 209-1652

www.beytagear.com

**You Have
Questions.
We Have
Answers.**

Gear Technology's "Ask the Expert" column has been one of our most popular features over the years. But our experts are getting bored and lonely! Give us some questions, and we'll help you get the answers you need, while educating the gear industry at large! We're looking for your technical questions on gear design, manufacturing, inspection and use. And just like when you were in school, there are no dumb questions!

[www.geartechology.com/
asktheexpert.php](http://www.geartechology.com/asktheexpert.php)

operator access. Coupled with the MINERALIT polymer concrete machine base, EMAG offers the best in class solution for tight tolerance production work. According to data from USMTO, EMAG has earned 87% market share for Inverted Vertical Lathes over the past five years in the United States, and the company is hoping that this move will continue to help them expand.

In addition to EMAG's dominance in the production turning space, EMAG offers a range of technologies catered to similarly sized round parts. These additional technologies include power skiving, laser welding/hardening/cleaning, electro-chemical machining, hobbing, grinding, hard milling, and induction hardening. Linking this vast range of technologies together, allows EMAG's vision statement to become a reality for its customer base, by providing the best "Manufacturing Systems for Precision Metal Components." (www.emag.com)

Bourn & Koch ANNOUNCE NEW PRESIDENT

Bourn & Koch, Inc. recently announced that **Blake Consdorf** has been named president. Consdorf, who was most recently president and CEO of Felsomat USA, Inc. brings over 20 years of relevant industry and leadership experience in machine tools and automation to Bourn & Koch. Prior to Felsomat, Consdorf was divisional president and engineering manager at Acieta, and served as vice president of manufacturing and engineering at Wes-Tech Automation Solutions. Prior president and CEO of Bourn & Koch, Terry V. Derrico, will now serve as president and CEO of Precision Cutting Technologies. (www.bourn-koch.com)



Apex Tool Group (ATG)

PROMOTES FRUEHWALD TO LEAD GLOBAL POWERTOOLS

Apex Tool Group (ATG), a manufacturer and supplier of high-performance hand and power tools, tool storage, drill chucks, chain and electrical soldering products for industrial, commercial and demanding do-it-yourself applications, announces that **Bernd J. Fruehwald** has been promoted to senior vice president and president of its global power tools business unit, which includes Cleco, Weller, and APEX.



Weller Tools. He most recently served as vice president and president of the Europe, Middle East and Africa (EMEA) and Australia and New Zealand (ANZ) regions of ATG's global power tools and hand tools divisions.

"In multiple roles with ATG, Bernd has demonstrated the ability to grow market share, establish effective business processes and drive further efficiencies in our European business," said Jim Roberts, CEO. "We look forward to Bernd's leadership of our strategically important power tools business."

Prior to ATG, he held executive roles with Bühler Motor GmbH, a privately-held global manufacturer and marketer of motion control motors, actuators and mechatronic drive solutions. He served as vice president for its industrial and health-care business units; vice president, Global R&D; and vice president of its PMO office. While at Bühler he was named an officer, and also served on its board of directors.

He holds an MBA from St. Gallen Business School in Switzerland and Alpen-Adria-Universität Klagenfurt, and earned a mechanical engineering degree from Technical High School Ansbach. (www.apextoolgroup.com)

API Metrology LAUNCHES VIRTUAL SHOWROOM

In addition to their recent development of global studios for Live Web Demonstrations, API has launched a full online Virtual Showroom to support their customer's growing need for online support and resources.



The speed of modern manufacturing is making the business model of a salesman who travels to a customer site with a full equipment line for in-person product demonstrations a luxury that cannot always be indulged.

To support businesses that need information and resources instantly, API is launching a Virtual Showroom. The Virtual Showroom is a continually updated one-stop information portal for API's Products and Services. Inside you can find virtual demos, technical videos, motion brochures, and more for API Products from Radian Laser Trackers and accessories to the API Arm. There are also resources for downloading more information, requesting quotes, or connecting with API directly by phone or email.

Customers will now be able to access detailed videos showing full product demonstrations, feature overviews, and technical discussions to take them through the operation of API's

products inside and out without needing to click through navigation menus or give out personal information. These materials will be available 24/7 to support API's global consumer base.

"The business world requires a new paradigm," says Joe Bioty, president of API. "In-person, onsite support will always be essential, and will always be a cornerstone for API, but decisions happen at lightning speed. There isn't always time to wait for someone to come to you. The Virtual Showroom takes API directly to the customer, putting all of the information about our products and how we can support all manufacturing processes at their fingertips." (www.apimetrology.com/virtual-showroom)

Manufacturing Institute

EXAMINES DEMAND FOR RESKILLED WORKERS

During its 8-week shutdown resulting from the COVID-19 pandemic, two students enrolled in the eKentucky Advanced Manufacturing Institute (eKAMI) secured CNC machining jobs with leading manufacturers, with other companies calling the school with plans to hire new graduates in the coming weeks. Director Kathy Walker sees this interest as an indication that US manufacturing will see a resurgence, with recent surveys showing nearly two-thirds of manufacturers in North America plan to hire domestically instead of sending jobs overseas. "There remains a strong demand for high-skilled positions in advanced manufacturing, particularly in automation and robotics," said Walker, who founded the eKAMI Haas Center along with the Gene Haas organization in 2017 to reskill displaced coal miners and other workers to build the quality workforce needed to attract manufacturing jobs to the region. Students are trained for high-tech positions in CNC machining on the latest, state-of-the-art Haas equipment in 16- and 36-week immersive courses. eKAMI graduates have been hired by companies such



as AutoGuide Mobile Robots, Heartland Automation, Roush Yates Engines, Lockheed Martin and Caterpillar's Progress Rail.

"The COVID-19 situation revealed serious deficiencies in our domestic supply chain," Walker said. "As a result, we are already seeing signs of a resurgence in US manufacturing, as an increasing number of manufacturers prepare to reshore jobs. Unfortunately, the skills gap remains for higher-level trades, driving the urgent need for automation. Our goal is to respond to industry demand by providing our workforce with the necessary tools to meet that challenge."

Keeping Busy During the Pandemic: Printing and Donating 3D Masks

eKAMI practices what it teaches in terms of responding to market needs with advanced manufacturing techniques. When the school first closed its doors to students in mid-March, staff members suggested putting their advanced manufacturing skills—and the 3D printers—to work. After designing face shields themselves, they have made and donated thousands to rural frontline medical facilities, including hospitals, nursing homes, fire departments, police departments and even correctional facilities, funded in partnership with Pop's Chevrolet and Citizens Bank of Kentucky. According to Walker, the demand hasn't waned, so they will continue making and donating the shields, even with their students now back in the classroom.

"Our staff teaches students how to adapt to rapidly changing environments utilizing innovation to solve manufacturing needs," Walker said. "Using technology skills, but quickly switching gears to mass produce on the 3D printers to create much-needed masks, is one example our students can follow as they return to class to complete their certifications before heading out into the workforce."

Healthcare facilities in Prestonsburg, Kentucky, benefited from eKAMI's innovations. "eKAMI stepped up, responded to an urgent need, and fulfilled it beyond anyone's expectations," said Mayor Les Stapleton. "They rapidly transitioned from producing precision parts to producing medical face shields. When the shortage of quality shields was noted, within days they were producing PPE to be used by our region's frontline EMS and Healthcare workers."

Highlands Appalachian Regional Healthcare Medical Center in Prestonburg was one of the first recipients. "ARH is proud to have a community partner like eKAMI to support our system," said Tim Hatfield, community chief executive officer. "Over the past several weeks, eKAMI has worked to produce 1,750 face shields for our frontline staff. We are truly blessed with Kathy Walker, her team, and her vision of training local folks to meet an industry demand."

"I am so thankful to eKAMI for the design and production of face shields," said Dr. Andy Keaton, of Keaton Orthodontics in Pikeville, Kentucky. "I could not obtain face shields through any of the national dental suppliers. The quality of the face shields was consistent with any I might have purchased from a national supply company."

The Haas eKentucky Advanced Manufacturing Institute (eKAMI) launched in 2017 with the goal of building the skilled workforce needed to attract quality, high-paying jobs in manufacturing to the region. Students 18 years and up participate in

16- and 36-week accelerated programs in computer numerical control (CNC) machinery, for the aerospace, robotics, medical and other advanced manufacturing industries.

(www.ekyami.com)

Klingelberg

WINS BEST OF INDUSTRY AWARD FOR THE SECOND TIME

For the fifth year running, the trade magazine *MM Maschinenmarkt* honored outstanding industry innovations with its “Best of Industry Award” on June 25, 2020. In total, 22 companies vied for the prize in nine categories. Klingelberg was among the lucky winners, receiving accolades in the “Measurement Technology” category for its “Complete Measurement in a Single Stage – Done-in-One” solution.

Already a winner of the prestigious award in 2018 for its “Cyberphysical Production System” in the “Industry 4.0” category, the machine manufacturer once again won over the jury of experts for the “Best of Industry Award 2020.” The jury selection was preceded by an online reader vote, which accounted for 50% of the evaluation process. Only select prize-winning industrial products were eligible for the nomination. Qualified nominees included products or solutions from all branches of industry that had already won an industry award in 2019 or had been short-listed, or received the most clicks from readers of the *MM* trade magazine.

“We are delighted to be among the award winners for the second time,” said Dr. Christof Gorgels, head of precision measuring centers. “The award is hugely important for us and once again highlights our innovative capacity in the marketplace.” The gala, which could not be held as a live event with an audience as originally planned, was pre-recorded at the event organizer’s in-house studio. The video is available to anyone interested on the social media channel YouTube at the website below. During the recording, all nominees and products were presented and, of course, the winners enjoyed a congratulatory speech given by the editorial staff of *MM Maschinenmarkt*. (www.klingelberg.com)



Daubert Cromwell

COMPLETES REACH CERTIFICATION

Daubert Cromwell has successfully completed all the requirements for certification with the European Union’s REACH (Registration, Evaluation and Authorization of Chemicals) Regulation. This important distinction means Daubert Cromwell can provide multi-national customers with an uninterrupted supply of VCI papers, films and devices that meet conditions of environmental safety set by the European Chemicals Agency.



REACH requires all companies that manufacture or import chemical substances into the EU to address the potential impacts on both human health and the environment. After years of research into how best to comply with the ruling and meet the packaging requirements of metalworking markets, Daubert Cromwell chose to register substances used in a broad range of best-selling VCI products in the categories of papers, films and devices. The assigned REACH registration numbers cover popular VCI papers MasterShield and PowerShield, and global brands of VCI films including Premium Metal-Guard, ClearPakBIO and ClearPak5000.

“We made a substantial commitment of time, financial and technical resources to meet all of the requirements necessary to be REACH registered,” said Daubert Cromwell President & CEO Martin J. Simpson. “Our customers cannot afford to have their shipments into the EU delayed, or rejected, because the packaging used to protect their valuable machinery is not officially registered. We want to provide customers with the quality VCI products they need, regardless of location, without worry they will be held up or penalized for non-compliance.”

(www.daubertcromwell.com)

FANUC

OFFERS FREE TRIAL VERSION OF CNC GUIDE

FANUC America is offering a free trial version of CNC Guide – FANUC’s PC-based virtualization platform for control design, training and part programming.

To assist machine tool operators and builders through the rough economic times created in 2020, FANUC is offering this simulation tool at no cost. CNC Guide offers an immersive and safe way to learn how to operate CNCs, even for novice operators. Because the software creates digital twins of machine controls, programmers can test G-code programs with no risk of damaging actual machines.

CNC Guide can also help optimize machining operations since users can experiment in the virtual environment with performance-enhancing features in FANUC controls. In addition, the software used in tandem with our conversational programming tool, Manual Guide i, can act as a simplified CAD/CAM package. This platform enables programming on a PC instead of the machine tool, so equipment stays in production to minimize downtime and maximize throughput.



FANUC CNC Guide is not only beneficial for machine tool operators, but also builders. Machine tool builders can get a competitive edge by using CNC Guide to prove out their design concepts faster and get their equipment quicker to market.

This limited-time offer is good only through September 2020 and available to FANUC America customers residing in the U.S. Interested parties need to contact FANUC through the CNC Guide Trial Offering page to get started.

(www.fanucamerica.com/products/cnc/software/cnc-guide/free-trial)

QuesTek

ANNOUNCES HIGH-PERFORMANCE STAINLESS STEEL MATERIAL FOR AM APPLICATIONS

QuesTek Innovations LLC, recently announced a stainless steel composition for powder bed fusion additive manufacturing (AM) for use either in the as-printed condition or with a single low-temperature heat treatment. This development is significant because it allows for production of complex, high-strength stainless parts via AM, comparable to wrought 17-4 PH, but without the need for expensive cryogenic processing or high-temperature heat treatment. The project has been funded by the US Navy Small Business Innovation Research program.

Commonly used 17-4 steel in AM often requires higher-cost argon-atomized powder to avoid retained austenite issues and it yields poor properties; however, even properties of argon-atomized 17-4 properties fluctuate widely and are sensitive to the feedstock composition.

Commenting on this development, Dr. Dana Frankel, QuesTek manager of design and product development said, “With QuesTek’s QT 17-4 powders, a fully martensitic microstructure is achieved in the as-printed condition. The high temperature solution heat treatment process, required for conventional 17-4, is not needed for QuesTek’s alloys, and the resulting properties have less variation.”

Two feedstock options are available: QT 17-4 for use in the direct aged condition and QT 17-4+ for use in the as-printed condition. The corrosion resistance and fatigue performance of both designed AM alloys is equivalent or improved over AM material printed using commercially available 17-4 powders.



Although QuesTek’s initial effort has focused on powder-based AM, it plans to demonstrate in one or more wire-based AM processes to enable larger component production at lower cost.

QuesTek’s new 17-4 powders can be used in a wide range of industries, including aerospace, defense, medical, chemical processing and energy. QuesTek’s powder was developed using its proven Integrated Computational Materials Engineering (ICME) technologies and Materials by Design approach.

QuesTek is in discussions with commercialization partners including alloy producers, metal AM machine manufacturers and service bureaus to license these technologies and accelerate commercial adoption. (www.questek.com)

Amorphology – Page 23
amorphology.com

B&R Machine and Gear Corp. – Page 11
www.brgear.com

Beyta Gear Service – Page 57
www.beytagear.com

Bourn & Koch – Page 7
www.bourn-koch.com

Cattini North America – Page 30
www.cattiniNA.com

Circle Gear – Page 28
www.circlegear.com

Dillon Manufacturing – Page 31
dillonmfg.com

DTR Corp. – Page 21
www.dragon.co.kr

DVS Group – Front Cover, Page 3
www.dvs-technology.com

EMAG – Page 25
www.emag.com

Forest City Gear – Page 19
www.forestcitygear.com

Gear Research Institute – Page 29
gearresearch.org

Gleason Corporation – Pages 4, 17
www.gleason.com

Helios Gear Products – Page 26
HeliosGearProducts.com

Hobsource Inc. – Page 31
www.hobsource.com

Index Technologies Inc. – Page 29
www.indextechnologiesinc.com

ITW Heartland – Page 12
SpiroidGearing.com

KissSoft – Page 4
www.kisssoft.com

KlingelInberg – Outside Back Cover
www.klingelInberg.com

Liebherr – Page 5
www.liebherr.com

Lubriplate – Inside Back Cover
www.lubriplate.com

McInnes Rolled Rings – Page 13
www.mcinnesrolledrings.com

Midwest Gear & Tool – Page 4
mwgear@midwestgear.net

Mitsubishi Heavy Industries America – Page 8
www.mitsubishigearcenter.com

Nachi – Page 15
www.nachi-america.com

Nordex Inc. – Page 31
www.nordex.com

Oelheld US Inc. – Page 31
www.oelheld.com

Penta Gear Metrology – Pages 20, 28
www.gearinspection.com

Proto Manufacturing – Page 29
www.protoxrd.com

Star SU LLC – IFC-Page 1, Page 28
www.star-su.com

United Tool Supply – Page 30
unite-a-matic.com

Yager Gear – Page 32
www.yagergear.com

GOTTA GET BACK IN TIME...



It may not be as impressive as a DeLorean, but if time travel is your thing, we have you covered at

www.geartechnology.com

Today, our user-friendly archive (1984 to present) is now available online with an optimized search engine that allows subscribers to locate specific articles using keywords and phrases.

We've created a database where subscribers can peruse more than thirty-five years of gear manufacturing articles without leaving their desks.

In an era where content is king, let *Gear Technology* be your destination for the past, present and future of gear manufacturing.

www.geartechnology.com/issues

RESPONSE REQUIRED

YES I want to receive/continue to receive *Gear Technology*

NO Thanks anyway, but I don't need the world's best publication on gear engineering and manufacturing.

Name _____ Job Title _____
(please print)

Signature _____ Date _____
(required)

How would you like to receive *Gear Technology*?

- PRINT version (Verify mailing info below)
- DIGITAL Version (E-mail required)
- BOTH Print AND Digital (E-mail required)

E-mail _____ *

How are you involved with GEARS?

- My company MAKES GEARS (20)
- My company BUYS GEARS (22)
- I DESIGN gears (23)
- I am a SUPPLIER to the GEAR INDUSTRY (24)
- OTHER (Please describe) _____

What is your company's principal product or service? _____

***Your PRIVACY is important to us. You get to CHOOSE how we use your personal information. The next e-mail we send you will have clear instructions.**

MAILING INFORMATION

NAME:

JOB TITLE:

COMPANY:

ADDRESS:

- Check if this is a home address

CITY:

STATE/Province:

ZIP/Postal Code:

PHONE:

FAX:

Put your business card here to make it easier!



Mail to:
1840 Jarvis Ave., Elk Grove Village, IL 60007 USA

or

FAX to 1-847-437-6618
SCAN to: subscribe@geartechnology.com

Rudolf Diesel – Man of Motion and Mystery

Jack McGuinn, Senior Editor

You have to admit, having an engine named after you is a singularly impressive achievement. After all, the combustion engine isn't named for anyone. No one refers to the steam engine as "the Watt" engine.

But then along came Rudolf Diesel (1858–1913), and with him — the Diesel engine, the engine that literally took the steam out of a wide range of engine applications. Born in Paris to Bavarian immigrants in somewhat humble circumstances — his father Theodor was a bookbinder and leather goods manufacturer — Rudolf was shortly after birth sent to live for nine months with a family of farmers in Vincennes, for reasons that remain

sketchy. Upon return to his parents, Rudolf was excelling in school while working for his father delivering leather goods from his workshop. With the Franco-Prussian War raging, his family — as did many other Germans — left Paris for London. Before the war's end, his mother sent him to Augsburg to live with an aunt and uncle to learn German and attend the Royal County Vocational College. At age 14, Diesel declared his intention to become an engineer. He then eventually attended on scholarship the Royal Bavarian Polytechnic of Munich, against his parents' wishes, who thought he should instead be looking for work.

A nurturing professor there was Carl von Linde, but Diesel's graduation was delayed by a bout with typhoid. But he soon began earning engineering experience at a machine works in Switzerland. He then graduated at the top of his class and moved back to Paris, where he was recruited by Linde for the design and construction of a then state-of-the-art refrigeration plant, of which he was named director a year later.

In 1890, a marriage and three children later, Diesel moved to Berlin and was managing Linde's corporate R&D department, where he also made the acquaintance of numerous influential business owners. While he developed a number of patents, he was not allowed to implement them while working for Linde, and so he decided to move on beyond the refrigeration industry. He pursued engine technology, researching thermal and fuel efficiency, working for instance with ammonia/vapor steam, which almost killed him during an explosion. Other close calls followed, including yet another explosion while researching high-compression cylinder pressures for iron and steel cylinder heads.

After a lengthy hospital stay, Diesel set out to design an internal combustion engine based on what is known as the Carnot cycle, a more thermally efficient technology. Several years later (1892), he received a German patent for his theory.

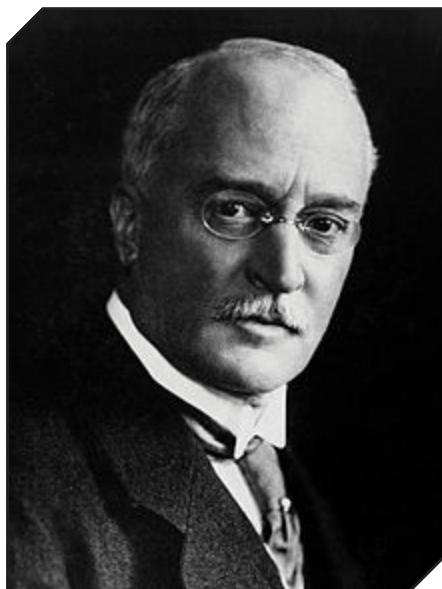

In 1893, he published his treatise, "Theory and Construction of a Rational Heat Engine to Replace the Steam Engine and the Combustion Engines Known Today." It was the foundation of his research that led to the Diesel engine. But later that year, it was back to the drawing board; Diesel came to realize that he wasn't there yet, and later that year filed another patent, correcting his mistake.

Central to Diesel's game-changing engine creation was his understanding of thermodynamics and fuel efficiency, and that "as much as 90%" of fuel energy "is wasted in a steam engine." Indeed, a signature accomplishment of Diesel's engine is its elevated efficiency ratios. After several years of further development with Heinrich von Buz of Augsburg's MAN SE, by 1897 the Diesel

engine was a reality.

Diesel's engine went on to replace the steam piston engine for many high-load applications. While because of its more robust weight and construction than the gasoline engine, the Diesel was never much of a candidate for aviation application, on the other hand, the engine soon became a mainstay for "stationary engines, agricultural and off-road machinery, submarines, shipping, locomotives and trucks." The engine was first run on peanut oil, and continues today to run on vegetable oil and biodiesel fuel refined from crude oil. It is a safer fuel source than gasoline, as its flash point is around 175 degrees F higher.

And now for the mystery.

In 1913, Diesel boarded the SS Dresden in Antwerp, headed for a Diesel corporate meeting. By all accounts, he had dinner onboard and retired to his cabin around 10 p.m., asking to be awakened by 6:15 a.m.

The following morning, Diesel's cabin was empty. His bed had not been slept in. His nightshirt was there, neatly folded. His watch was on a bedside table. He was never seen alive again. It was reported that his body was recovered a month later by a boatman, who then tossed it overboard "because of heavy weather."

Theories and rumors ensued. Some say it was suicide. Others believed he was murdered due to his refusal to grant the German armed forces exclusive rights to using his technology (remember this was on the eve of WWI). In fact, Diesel was scheduled to meet with British Royal Navy personnel "to discuss powering British submarines" with his engine.

None of this was ever proven and Diesel's death remains "unsolved." (Source: [Wikipedia](#).) 

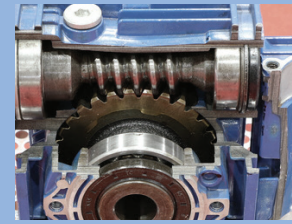
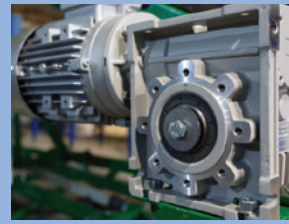
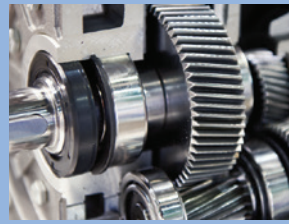
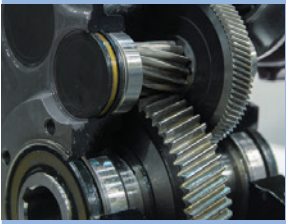

ADVANCED 100% SYNTHETIC GEAR OILS

**FROM A COMPANY ADVANCING
LUBRICATION FOR 150 YEARS**

150 years ago, our founders set out to make the highest quality, best performing lubricants available. In doing so, they helped pioneer the use of anti-wear additives that significantly increased lubricant performance through the years. Today, that innovative tradition continues with our newest line of ultra high-performance, 100% synthetic gear oils. These new lubricants provide a wide range of benefits including: extended fluid change intervals, cooler operating temperatures, reduced friction and reduced downtime.

Products include...

SYN LUBE SERIES 150 - 1000

High performance, fully compatible PAO-based gear oils.

SYN LUBE HD SERIES

Heavy-duty, (EP) extreme pressure, PAO-based gear oils.

SYNTHETIC WORM GEAR LUBRICANT

High performance, ISO 460 Grade, PAO-based worm gear oil.

PGO SERIES

Ultra high-performance, PAG-based gear oils.

PGO-FGL SERIES

NSF H1 registered, food machinery grade, PAG-based gear oils.

SFGO ULTRA SERIES 150 - 1000

NSF H1 registered, food machinery grade, PAO-based gear oils.

QUALITY
INNOVATION
PERFORMANCE
FOR 150 YEARS



CELEBRATING
150 YEARS
OF QUALITY, INNOVATION
AND PERFORMANCE

INCLUDED AT NO ADDITIONAL CHARGE



Complimentary Extra Services Package

- COLOR CODED LUBE CHARTS & MACHINERY TAGS
- PLANT SURVEYS / TECH SUPPORT / TRAINING
- LUBRICATION SOFTWARE / FOLLOW-UP OIL ANALYSIS

LUBRIPLATE LUBRICANTS COMPANY
NEWARK, NJ 07105 / TOLEDO, OH 43605 / 800-733-4755
LubeXpert@lubriplate.com / www.lubriplate.com



KLINGELNBERG – QUALITY AND COMPETENCE THAT IMPRESS!

COMPETENT AND COMPREHENSIVE SERVICE



KLINGELNBERG



WE ARE THERE FOR YOU
Our worldwide sales and service representatives are always there for you. You can find your local Klingelberg service partner at:
www.klingelberg.com/contact

Our understanding of precision and reliability goes well beyond our products. That is why we provide our customers with comprehensive service in the Klingelberg business areas, with a focus on individual, customer-specific requirements. Be it all-round support throughout the lifecycle of the machine or individual service modules – made-to-measure, coordinated solution packages and competent discussion partners are the norm at Klingelberg. Our well-trained service technicians are available in every phase of the lifecycle of your Klingelberg machines and measuring devices. Klingelberg provides a range of interlinked services, which you can use as an overall package or in modules. We offer service that perfectly matches your ideas and meets your requirements.



Refurbishment
the Video

BEVEL GEAR TECHNOLOGY | CYLINDRICAL GEAR TECHNOLOGY | PRECISION MEASURING CENTERS | DRIVE TECHNOLOGY

WWW.KLINGELNBERG.COM