

PRESHOW  
GEAR EXPO '87

# GEAR TECHNOLOGY

*The Journal of Gear Manufacturing*

JULY/AUGUST 1987

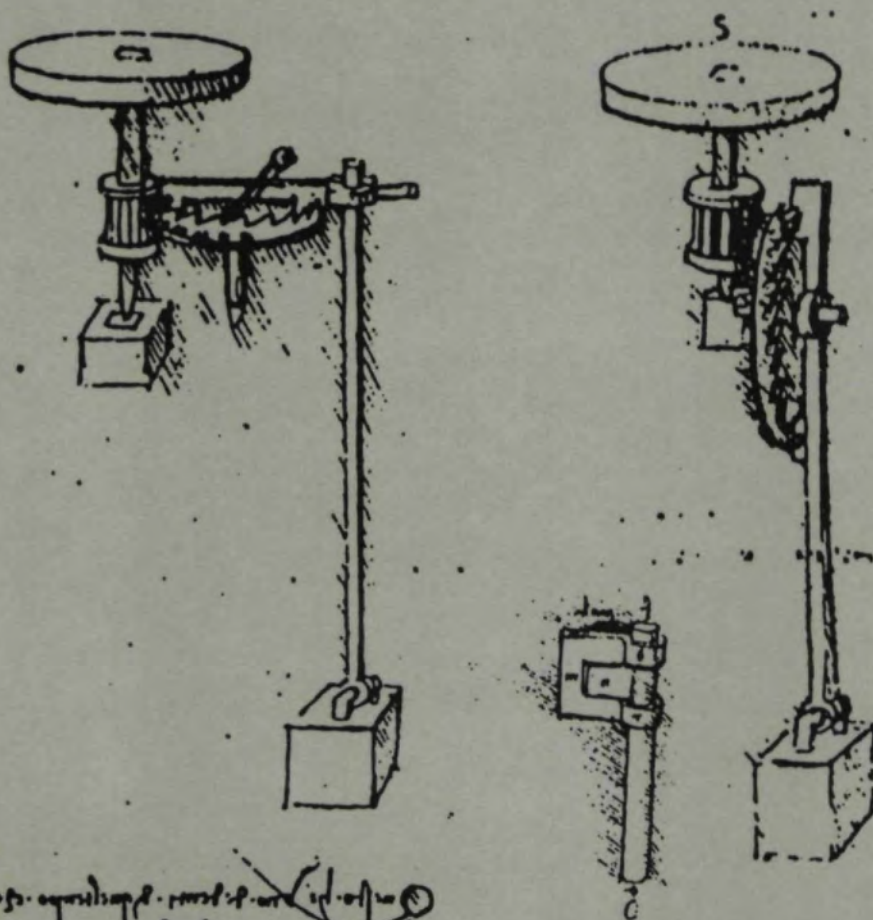

**Longitudinal Load Distribution Factor for Straddle-  
and Overhang- Mounted Gears**

**Helical Gears With Circular Arc Teeth**

**Cutting Fluid Selection and Process Controls**

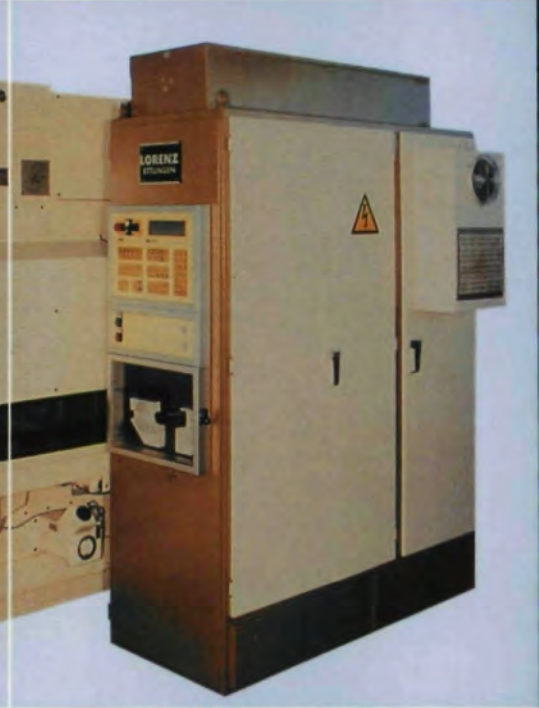
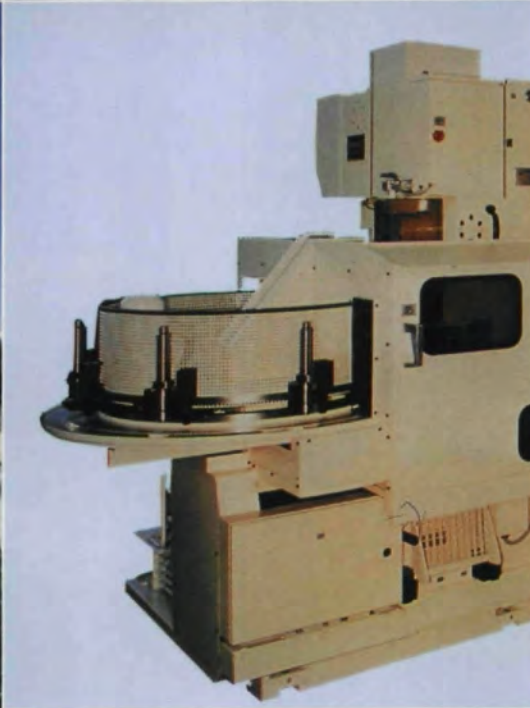

# What does every competitive gearmaker in the business have in common?

## **APL Experience**

From high production manufacturing lines to small job shops, knowledgeable gearmakers rely on the most experienced CNC machines in the industry...Pfauter and Lorenz from American Pfauter. In particular, the PE 150 CNC Hobber and the LS 152 CNC Shaper, which are CAD/CAM designed, engineered and built by American Pfauter, are used in more gear manufacturing applications today than any other CNC machines.

## **APL Flexibility**

One major reason for the widespread popularity of both machines is their complete flexibility to handle virtually any lot size economically. Latest generation CNC controls make program preparation and execution an easy task for a single operator. The PE 150 and LS 152 have become the reliable standards in aerospace, automotive, truck and tractor, and job shops of every size.

## **APL Automation**

Another reason for broad industry acceptance of the PE 150 and LS 152 is their adaptability to flexible automation systems. Loading/unloading systems are designed to minimize non-productive time. Expandable storage capacity substantially increases unattended operation. Simple, quick-change tooling increases efficiency.

## **APL Commitment**

American Pfauter is committed to offering the finest CNC gear manufacturing equipment available. Everything from individual hobbing, grinding, shaping, measuring and finishing machines, to customized flexible gear manufacturing cells and systems for large or small lot sizes.

For additional information, contact American Pfauter Ltd., 925 Estes Avenue Elk Grove Village, IL 60007. Phone (312) 640-7500.

**AMERICAN PFAUTER**  
*Building American Productivity*



*Come see us at Booth 401.*  
CIRCLE A-1 ON READER REPLY CARD





CINCINNATI, OHIO  
OCTOBER 4-6, 1987  
BOOTH #434-436

# PRECISE.

## The fully automatic CNC controlled PNC-40 Gear Tester

The PNC-40 is the fastest, most accurate gear tester available . . . anywhere. It was designed to meet or exceed the most demanding inspection requirements, of today's modern, gear production facility. The fully automatic, 6 axis, CNC controlled tester, checks; involute, lead, line of action, pitch and tooth concentricity of straight or helical gears and additional software packages are available.

Linked with an HP desk computer, the PNC-40 provides a system for fully automated data

evaluation and documentation to AGMA tolerance fields and customer tolerance specifications.

The addition of an industrial robot provides a fully automatic, unmanned, flexible inspection cell.

For further information and a copy of our complete literature, contact: Klingelberg Corporation, 15200 Foltz Industrial Parkway, Cleveland, OH 44136. Phone (216) 572-2100.



**KLINGELBERG**

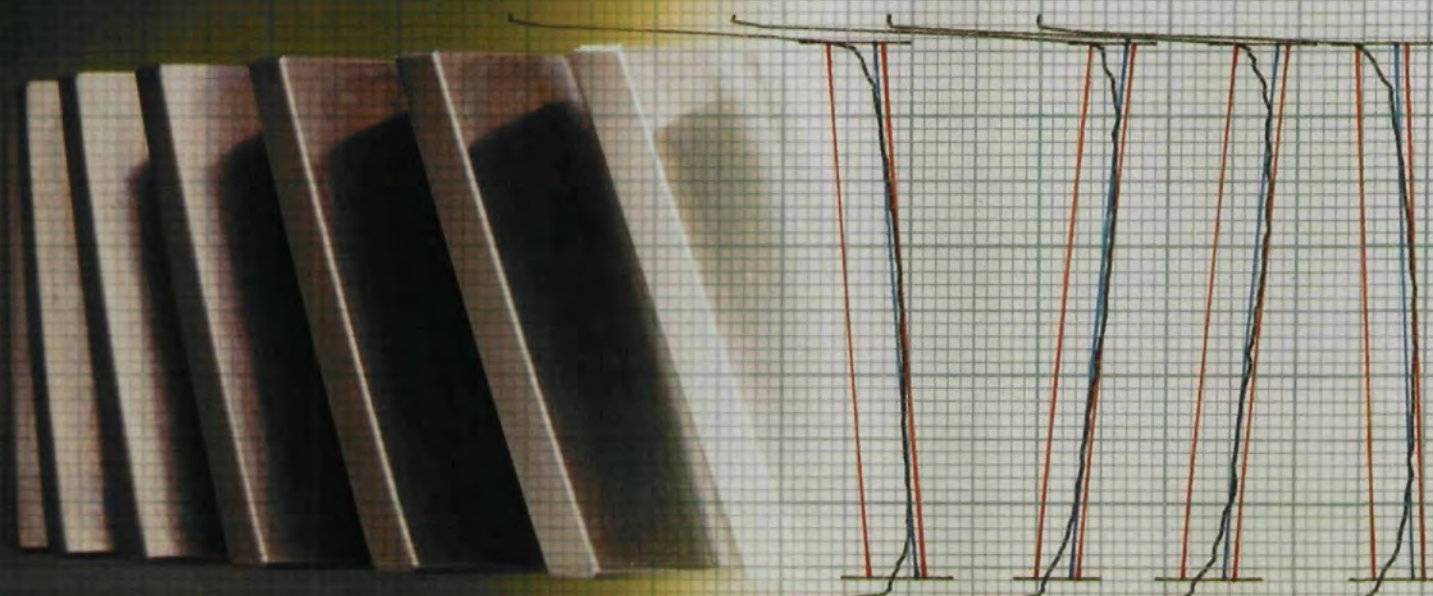

CIRCLE A-3 ON READER REPLY CARD

# GEAR

## TECHNOLOGY

The Journal of Gear Manufacturing

### EDITORIAL STAFF

**PUBLISHER &  
EDITOR-IN-CHIEF**  
Michael Goldstein

**ASSOCIATE PUBLISHER  
& MANAGING EDITOR**  
Peg Short

**PRODUCTION/ADVERTISING**  
Patricia Flam

**ASSISTANT EDITOR**  
Nancy Bartels

**EDITORIAL SECRETARY**  
Pamela Nolan

### RANDALL PUBLISHING STAFF

**PRESIDENT**  
Michael Goldstein

**VICE PRESIDENT**  
Richard Goldstein

**GENERAL MANAGER**  
Peg Short

**ART CONSULTANT**  
Marsha Goldstein

**RANDALL PUBLISHING**  
1425 Lunt Avenue  
P.O. Box 1426  
Elk Grove, IL 60007  
(312) 437-6604

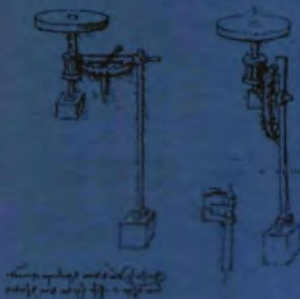

The Advanced Technology  
of  
Leonardo Da Vinci  
1452-1519

#### COVER

According to Leonardo, "Mechanical science is most noble and useful above all others, for by means of it all animated bodies in motion perform their operations." These drawings of "animated bodies in motion" are pendulums. The one on the right has a vertical crown wheel, and the one on the left, a horizontal one. Leonardo's comments on the sketches indicate he was concerned with possible uses for the pendulum, not only in clockworks, but also in other devices.

## CONTENTS

## PAGE NO.

### FEATURES

- |   |    |
|---|----|
| <b>LONGITUDINAL LOAD DISTRIBUTION FACTOR FOR STRADDLE- AND OVERHANG- MOUNTED SPUR GEARS</b>           | 11 |
| Toshimi Tobe<br>Katsumi Inoue   |    |
| <b>HELICAL GEARS WITH CIRCULAR ARC TEETH: SIMULATION OF CONDITIONS OF MESHING AND BEARING CONTACT</b> | 22 |
| F. L. Litvin<br>Chung-Biau Tsay   |    |

### DEPARTMENTS

- |  |    |
|--|----|
| <b>TECHNICAL CALENDAR</b>  | 4  |
| <b>EDITORIAL</b>   | 5  |
| <b>GUEST EDITORIAL</b>   | 9  |
| <b>GEAR EXPO</b>   | 9  |
| <b>VIEWPOINT</b>   | 10 |
| <b>BACK TO BASICS . . . CUTTING FLUID SELECTION AND PROCESS CONTROLS FOR THE GEAR MANUFACTURING INDUSTRY</b> | 37 |
| Ike Tripp, Jr.   |    |
| <b>ADVERTISERS' INDEX</b>  | 46 |
| <b>CLASSIFIED</b>  | 47 |

July/August 1987

Vol. 4, No. 4

**GEAR TECHNOLOGY, The Journal of Gear Manufacturing** (ISSN 0743-6858) is published bimonthly by Randall Publishing Co., Inc., 1425 Lunt Avenue, P. O. Box 1426, Elk Grove Village, IL 60007. GEAR TECHNOLOGY, The Journal of Gear Manufacturing is distributed free of charge to qualified individuals and firms in the gear manufacturing industry. Subscription rates for non-qualified individuals and firms are: \$35.00 in the United States, \$55.00 for foreign countries. Second-Class postage paid at Arlington Heights, IL and at additional mailing office.

Postmaster: Send address changes to GEAR TECHNOLOGY, The Journal of Gear Manufacturing, 1425 Lunt Avenue, P. O. Box 1426, Elk Grove Village, IL 60007.

©Contents copyrighted by RANDALL PUBLISHING CO., INC. 1987. Articles appearing in GEAR TECHNOLOGY may not be reproduced in whole or in part without the express permission of the publisher or the author.

**MANUSCRIPTS:** We are requesting technical papers with an educational emphasis for anyone having anything to do with the design, manufacture, testing or processing of gears. Subjects sought are solutions to specific problems, explanations of new technology, techniques, designs, processes, and alternative manufacturing methods. These can range from the "How to . . ." of gear cutting (BACK TO BASICS) to the most advanced technology. All manuscripts submitted will be carefully considered. However, the Publisher assumes no responsibility for the safety or return of manuscripts. Manuscripts must be accompanied by a self-addressed, self-stamped envelope, and be sent to GEAR TECHNOLOGY, The Journal of Gear Manufacturing, P.O. Box 1426, Elk Grove, IL 60007, (312) 437-6604.

# TECHNICAL CALENDAR

**SEPTEMBER 1-3**

**SME Workshop — EDM CLINIC**

Hyatt Regency Woodfield  
Schaumburg, IL\*

\*NOTE change of date & location.

**SEPTEMBER 12-26** — AGMA trip to visit gear manufacturing and machine tool plants in Switzerland, Germany and Belgium. Included will be a visit to the Gear Research Institutes in Munich and Aachen. For further information, contact Mr. Joe Arvin, Arrow Gear Co., 2301 Curtiss St., Downers Grove, IL 60515. (312) 969-7640.

**SEPTEMBER 16-18**

**GEAR NOISE SEMINAR — Ohio State University.**

This course will cover general noise measurements and analysis, causes of gear noise, gear noise reduction techniques, dynamic modeling, gear noise signal analysis and modal analysis of gear boxes. For further information, contact Mr. Richard D. Frasher, Director of

Continuing Education, College of Engineering, 2070 Neil Avenue, Columbus, OH 43210. (614) 292-8143.

**OCTOBER 4-6**

**AGMA — GEAR EXPO '87**

Cincinnati Convention Center  
Cincinnati, OH

**OCTOBER 5-7**

**AGMA — FALL TECHNICAL MEETING**

Hyatt Regency Cincinnati  
Cincinnati, OH

For further information: SME events, contact: Joe Franchini, One SME Drive, P. O. Box 930, Dearborn, MI 48121 (313) 271-1500 x394.

AGMA events, contact: AGMA 1500 King St., Suite 201, Alexandria, VA 22314 (703) 684-0211.

(continued on page 48)

## UNHEARD OF . Possibly,

you have never heard of *IN* . But, thousands of our variety of gear producing machines have been manufactured for 40 years.

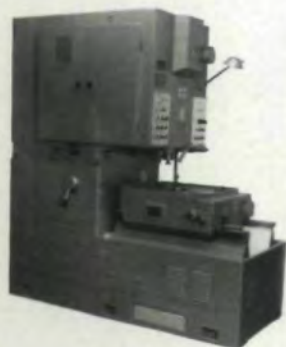

(USER REFERENCES AVAILABLE)

**GEAR SHAPERS**

Model #GSB-2 (8" dia. x 2" face)  
Model #GS20-5 (20" dia. x 5" face)  
(ILLUSTRATED AT LEFT)

**OTHER MACHINES**

Bevel gear generators: spiral & straight  
Cutter grinders: shaping, shaving & hob  
Cycloid gear millers  
Gear grinders: straight, conical, internal  
cycloidal & "worm" wheel  
Gear hobbors: 1 inch to 40 foot diameter  
Gear honing machines  
Gear noise testing machines  
Gear shavers  
Hypoid generators, lappers & testers  
Rack shapers  
Spline shaft milling machines  
Tooth chamfering machines  
Worm wheel hobbors

**SPECIFICATIONS**

Maximum gear diameter: 20"  
Maximum face width: 5"  
Maximum pitch: 4DP  
Includes: (50) change gears  
Magnetic chip conveyor

**INTRODUCTORY PRICE**

Model #GSB-2 \$27,750 reduced to \$19,450  
Model #GS20-5 \$79,995 reduced to \$55,950  
(LIMITED OFFER)  
Visit our Detroit "DEMO-CENTER" to see  
for yourself: (313) 651-1200 (Dick Fike)

## UNHEARD OF - Increased profits

as a result of investing 25% of that you would expect.



P. O. BOX 36754  
LOS ANGELES, CA 90036  
(213) 933-0311

CIRCLE A-9 ON READER REPLY CARD

## DEBURR SIMPLE OR DIFFICULT GEARS

and smooth radii and edges on internal or external surfaces completely and efficiently time after time. ANODE MECHANICAL DEBURRING (AMD), invented and developed by Cation, combines a special moving tool-cathode with electrochemical metal removal. AMD removes heavy and irregular burrs with minimal effect on the

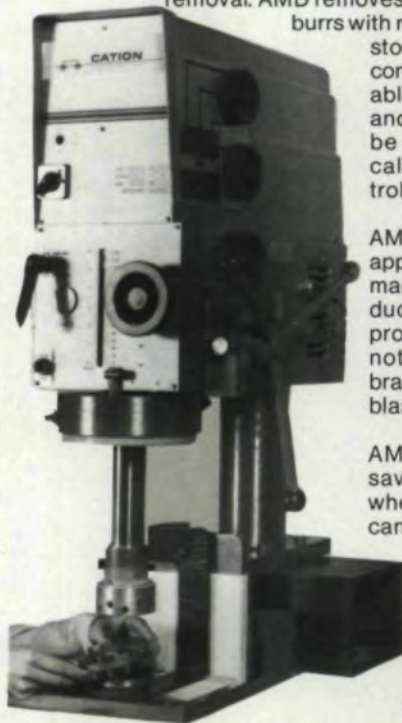

stock. AMD is precisely controllable and repeatable. Edge break, radii and stock removal can be accurately pre-calculated and controlled.

AMD is stress free and applies to any stamped, machined or cast conductive metal. Use it productively on parts not responsive to vibration, tumbling and blasting.

AMD produces cost savings and deburrs where other methods can't.

**CATION**  
CORPORATION

99 Ridgeland Rd.  
Rochester, NY 14623  
716-427-2460

CIRCLE A-40 ON READER REPLY CARD

# EDITORIAL

## SIMPLE STRATEGIES FOR SUCCESSFUL COMPETITORS

"Competitiveness" is the newest corporate buzzword. It is being offered as the solution to all our economic problems. Newspapers, magazines and legislators are pushing us to be more "competitive." We are given advice about installing advanced manufacturing systems and robotics, integrating computers into our operations, understanding trade laws and international economics, and practicing the latest management techniques — all in the name of "competitiveness".

Competition is the name of the game, but then it always has been. Some of the best techniques for getting and keeping a competitive edge are the oldest and the simplest — the ones we tend to forget in the midst of all the excitement about "state-of-the-art" approaches.

A program about excellence in corporate America illustrates this point. Ten highly competitive companies that practice "excellence" as a corporate way of life were analyzed to discover the "secrets" of their success. These companies represent a cross section of American business. They include a major over-night delivery service, a small Midwestern bank, a national women's clothing chain and a large appliance manufacturer. They range in size from several thousand employees and hundreds of millions of dollars in sales a year to less than twenty employees and just a few million. Their target markets and their customers are vastly different; yet this diverse group has two strategies in common for remaining competitive. They care about their customers, and they care about their employees.

Customer care comes down to the simple, old-fashioned approach of treating customers the way we would like to be treated. Promises made are kept; delivery dates, met; phone calls, returned. Customers talk to real people with real names, not recordings or computers. Problems that arise with products or services are not ignored, but solved — frequently at the expense of the seller. These companies routinely go the extra mile to serve a customer. The president of a major retailer featured in this program answers his own phone — except on the days when he is on the floor of one of his branch stores. The small bank offers free-of-charge assistance to customers in balancing their check books. Neither of these practices is "necessary" or, perhaps even "cost effective," but in both cases, the good will acquired seems to far outweigh any costs.

Of course, all the "niceness" and "customer service" in the world won't make up for a shoddy product. How do these companies manage to deliver a good product?



By getting and keeping good employees that care about the work they do and the products they deliver.

And where do these employees come from? Interestingly enough, these companies draw from the same group of employable people as the rest of us, and, while their wage-and-benefits packages are competitive, they are not out of line with the rest of the market. Employee pride and loyalty come from far more than an attractive wage package.

These companies show the same kind of fundamental respect and concern for their employees that they do for their customers, and the results show in the products and services they produce. In these companies, the management does not have an "us" and "them" attitude toward its workers. Rather, it recognizes that the company is all "us," working to do the best job possible.

Safe, pleasant working conditions are provided. Changes in work routines and environment are not made arbitrarily, but in consultation with the people who will be affected. Good performance is rewarded. Employee ideas and suggestions are encouraged and respected. These companies recognize that the person with 20 years on the shop floor may have some insight into production problems that the young graduate engineer or MBA may not. Employees in these companies have access to management, and an atmosphere of mutual respect is encouraged.

None of these ideas is "new" or mysterious. None of them require enormous outlays of capital or three-day training conferences to develop. They are so simple and basic that their greatest failing may be that they are so obvious that we tend to forget them.

The simple truth is this: A management policy that treats customers like kings and employees as respected and valuable partners is just as important a competitive tool as high-tech, state-of-the-art machines and processes.

A handwritten signature in black ink that reads "Michael Goldstein". The signature is written in a cursive, flowing style.

Michael Goldstein  
Editor/Publisher

# We make gear inspection with the simply marvelous

Our Model 3000 QC Gear Analyzer is a third generation CNC gear inspection system incorporating all of the comprehensive analytical tests and evaluation capabilities of previous M & M systems, such as our Model 2000, but with these added capabilities:

- Dramatically improved speed and accuracy through new mechanical system design and advanced CNC control. Ask about our proprietary ZFE (Zero Following Error) technology.
- Computer hardware and applications software are modular to allow the user to buy only the required capability. This makes the 3000 QC adaptable to laboratory testing or production-line inspection.
- Integrated Statistical Process Control with local data base capability is an optional feature.
- Networking with MAPS compatibility is available.
- Robotic interfacing for totally automatic load/test/unload operation can be incorporated.

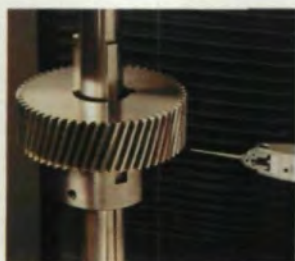

Smart™ Probe package. LVDT gage head and  $\mu$ processor-based converter deliver high-speed measurement data in  $\mu$ inches.



Operator Control Panel for part loading and machine set up. Also provides gage-head meter indication.



Alpha-numeric keyboard with "Mouse" for one-time entry of part print and tolerance data. "Mouse" permits use of CAD techniques.



# marvelously simple... 3000 QC System



All of these advanced features can be incorporated into the delivered system or added as a field upgrade at a later time. For more information or applications assistance, write or call:  
M & M Precision Systems, 300 Progress Rd., West Carrollton, OH 45449, 513/859-8273, TWX 810/450-2626, FAX 513/859-4452.

**M&M PRECISION SYSTEMS**

AN ACME-CLEVELAND COMPANY

Visit us at  
**GEAR EXPO '87**  
Booth #409



System Control Center is color graphics CRT with "touch-screen" control for fast and simple operation.

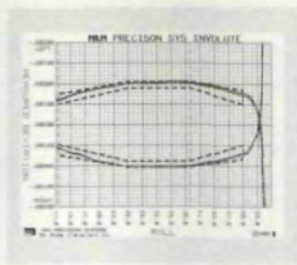

Graphics printer copies CRT graphics and tabular test data.

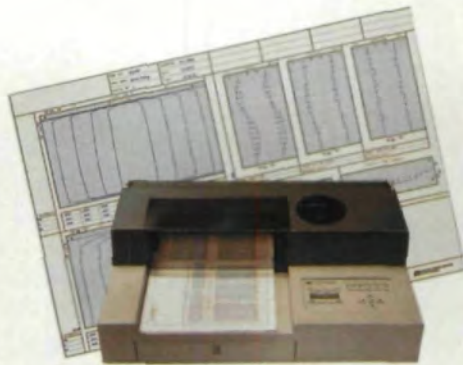

Graphics plotter delivers multi-color hard copy of graphics and tabular test data.



CNC status monitor provides status and positional display of mechanical system and CNC control functions.

CIRCLE A-6 ON READER REPLY CARD

# Welcome CIMA-USA



Manual Loading



Automatic Loading



Robot Loading System

## Cut your cost on every gear. Now that CIMA's here.

Forget that CIMA is one of the top gear hobbing machine producers in the world. Disregard the fact that you get superior reliability and engineering from a company that has been a gear cutter pioneer for over 40 years.

### Remember that CIMA started in Italy.

That's where CIMA built its legendary commitment to customer satisfaction. And, until now, that's where you had to go for CIMA quality. No more. CIMA USA is now headquartered in Richmond, Virginia. Which means your assembly takes place in America and every CIMA machine is now built to the American standard . . . your standard.

### Being in America, CIMA Saves You Money.

Now, you buy direct from an American manufacturer: CIMA USA. So, lower costs for you, plus better and faster CIMA service and more accessible CIMA gear production consultants.

You know that CIMA can reduce your labor cost per job. Because CIMA's advanced computerized automations trim set up time, speed up tool changes and provide greater cutting accuracy and flexibility.

### Get Savings In Gear with CIMA.

Better quality, lower costs. Now, get it all in gear with a call to CIMA-USA. Give us a welcome call or circle us on the reader card to cut your cost now that CIMA's here.

### CIMA-USA

Division of G.D. P.M. Inc.  
501 Southlake Boulevard  
Richmond, VA 23236  
(804) 794-9764

Telefax (804) 794-6187 • Telex 684-4252

## NO SURPRISE

For the last few years, the market has been tough for the U.S. gear industry. That statement will cause no one any surprise. The debate is about what to do. One sure sign of this is the enormous attention Congress and the federal government are now placing on "competitiveness."

As illustrated by the debates in Congress, there seem to be plenty of ideas. Reform of trade legislation constitutes one part of the answer, and changes in the tax or product liability laws would also help. AGMA is working for these reforms, but most often what I hear from gear executives is "success lies on my own shop floor, not in what Washington is going to do for me." Even if the federal government does remove some of the hurdles, the only winners in the "competitiveness race" are going to be those who decide on their own to put on track shoes.

It's easy to blame others for our problems—or to expect someone else to solve them. Even when there is a lot of justification for the feeling that someone else may be at fault, we're the only ones that really control our own fate.

This same idea was revealed in a recent survey of

AGMA members on the impact of international trade. Again, the results come as no surprise. How severely a company is feeling the pressures of competition, both domestically and internationally, has a direct correlation with the age of a gear company's equipment. One example was found among the manufacturers of fine pitch gearing—over two-thirds reported that they were experiencing severe competition. These same companies indicated that the average age of their machinery was 21.3 years. This is a big contrast to the other one-third of the fine pitch gear makers, whose average age of equipment was only 14.2 years, or 7.1 years less.



This seems to be an important statistic, especially since similar figures appear in almost every other segment of the industry studied. You can quickly draw the conclusion that to be truly competitive, you need to utilize the latest technology.

So how did that lead us to organize the AGMA trade show, GEAR EXPO '87? Again, no surprise, for there is a direct connection. For years, AGMA has been a good source of the latest technical information. Our standards development process and our meetings involve people drawn from every corner of the world,

(continued on page 10)

---

**Author: Mr. Richard B. Norment** is the Executive Director of the American Gear Manufacturers Association. He joined the AGMA staff in July of 1985, after working with the National Association of Manufacturers for over 10 years. He obtained a Masters Degree and did doctoral work in U.S. business history at The American University, where he also served on the faculty.

## GEAR EXPO GROWS UP

AGMA's Gear Expo '87 opens on October 4 and runs through October 6 at the Cincinnati Convention Center, Cincinnati, Ohio. Building on the foundation of the mini-show held last October in Chicago, AGMA this year offers over 30,000 sq. ft. of display space and more than 100 booths for those marketing directly to the gear manufacturing industry. This is the only U.S. show devoted exclusively to gears and gearing products.

In addition to expanded display space, Gear Expo also will have expanded exhibitor hours, with booths being open for a total of 22 hours over the three days of the show. Hours will be 10:00 to 6:00 on Sunday and Monday and noon to 6:00 on Tuesday.

The Fall Technical Meeting will be held in conjunction with Gear Expo '87. Papers and presentations on a variety of subjects will be offered, including gear geometry, bevel gearing, rating and loads, new inspection techniques, wear and materials and new manufacturing processes. The Technical Meeting will be held at the Cincinnati Hyatt Regency.

Gear Expo '87 and the Fall Technical Meeting are being held in Cincinnati, Ohio. Cincinnati is at the center of the U.S. gear industry. Almost half of the industry is located within 300 miles of the expo and meeting site.

For more information about Gear Expo '87 and the Fall Technical Meeting, call Wendy Peyton at AGMA Headquarters, (703) 684-0211.

## Gear Couplings

In the May/June issue of your excellent magazine, Mr. Stan Jakuba discusses a serious problem, not only for the gear industry, but any machinery where fluctuating torque is encountered. I would like to make the following comments to his article:

1. The statement "the transmission was properly selected and sized" is very wrong! If it were properly selected, it would not have failed! The engineer that selects a transmission cannot disregard the equipment the gears are connected to. It boggles my mind that someone would select a transmission based only on horsepower, speed and ratio, and would not ask what is the prime mover and the driven machine. If not the engineer that selected the transmission, who has the responsibility of selecting the couplings? Note the upper case S; Mr. Jakuba should have discussed the output coupling also. I would like to recommend to you an ASME paper written by Mr. John Wright and entitled "Flexible Couplings and the Cinderella Syndrome."

2. Mr. Jakuba's conclusion that one should select a coupling with "the lowest torsional spring rate" disregards the economics of coupling selection. Lower the spring rate — larger the coupling — higher the expense.

3. Mr. Jakuba makes the correct statement that the torque peaks "will be higher with higher equipment inertia"; which equipment? In the case he describes, it is apparent that the transmission was a speed increaser, hence, the engine was driving the gear (large inertia), and the pinion was driving the generator (very large inertia). Where should the "soft" coupling be installed? At the input or at the output shaft?

4. The conclusion I would have liked to have seen in Mr. Jakuba's article is: leave the coupling selection to the specialists! Select either a coupling manufacturer that makes more than one type of coupling or hire a specialized consultant to perform a design audit on the couplings which are proposed by various manufacturers.

Finally, Mr. Jakuba makes a basically wrong statement: "The culprit in the case was a coupling." The correct statement should have read: The culprit in the case was the inexperienced engineer who selected the wrong coupling.

Michael M. Calistrat  
Director of Engineering  
Boyce Engineering  
International, Inc.  
Houston, TX

### Mr. Jakuba's Reply:

*It is always a pleasure to read comments written by someone who is as knowledgeable about the subject as Mr. Calistrat obviously is.*

*Regarding his first comment, the objective of the paragraph was to present an attention catching example of the consequences of poor engineering judgment. The point was that*

*the same transmission could have performed satisfactorily were it connected to the engine through the right coupling for the job. As for the output coupling, the article's aim was to bring forth the problems associated with the transmittal of pulsating torque in drivelines of substantial polar inertias. The principles described are applicable to output couplings too. Mr. Calistrat rightly pointed out the need to apply these considerations to the other end of the transmission.*

*I have to disagree with Mr. Calistrat's statement that the selection of the coupling with "the lowest torsional spring rate" contradicts economics. In my experience, there is little, if any, price difference among couplings of basically the same size and configuration, but different spring rate. Sometimes, it is just a matter of specifying a different grade of the resilient material in the coupling, and the maker may be offering a wide range of these with no price difference.*

*In response to the third paragraph, the word equipment was used to refer to any kind of driven machinery. In the case described in the article where the coupling flexibility was to protect the transmission, the coupling would be most effective if installed on the output from the engine (input to the transmission).*

*Finally, as a consultant myself, I wholeheartedly agree with Mr. Calistrat's recommendation in the fourth paragraph.*

*(continued on page 44)*

## Guest Editorial

*(continued from pg. 9)*

enabling us to keep in touch with innovations in the design and manufacture of gears and gearing products. The world has become an international market place of ideas as well as goods, and AGMA provides one way to stay in touch with these developments. For example, the AGMA Fall Technical Meeting has grown to an internationally recognized session, both in attendance and sources of quality technical papers. This year, over a third of the abstracts received for presentation at this year's meeting came from sources outside of the U.S. and Canada.

As good as this past approach has been, there still is a strong need for people in the gear industry to have a place to SEE the latest innovations for both design and manufacturing. Existing trade shows do not offer an answer—exhibitors in larger shows have to market to the broadest group of attendees, and that just doesn't focus on gear people. The only answer seemed to be for AGMA to organize GEAR EXPO.

October 4-7 in Cincinnati provides a new option for the industry. With both the traditional AGMA Fall Technical Meeting and the new GEAR EXPO being held at that time, the industry will have a genuine opportunity to see what it can do to make itself more competitive. And here, there may be a surprise.

# Longitudinal Load Distribution Factor for Straddle- and Overhang-Mounted Spur Gears

Toshimi Tobe  
Katsumi Inoue  
Faculty of Engineering,  
Tohoku University,  
Sendai, Japan

## Abstract

Longitudinal load distribution and bending moment distributions at the root of a pair of spur gears with a known effective lead error are calculated by the finite element method based on plate theory. A convenient empirical formula for the longitudinal load distribution factor is proposed and compared with the formulas recommended by ISO and AGMA. The relation between the maximum bending moment at the root and the longitudinal load distribution factor is also presented. The effect of crowning on the longitudinal load distribution is investigated and the amount of arc-shaped crowning needed, which is frequently determined by the experience of gear designers, is determined by minimizing the longitudinal load distribution factor.

## Introduction

A pair of spur gears generally has an effective lead error which is caused, not only by manufacturing and assembling errors, but also by the deformations of shafts, bearings and housings due to the transmitted load. The longitudinal load distribution on a contact line of the teeth of the gears is not uniform because of the effective lead error. Longitudinal load distribution factors  $K_{H\beta}$  and  $K_{F\beta}$  are used in the ISO strength rating formula<sup>(1)</sup> to account for the effects of the non-uniform distribution of the load on the contact stress and the bending stress at the root.

Hayashi<sup>(2)</sup> solved integral equations to calculate the load distribution of helical gears. Conry and Seireg<sup>(3)</sup> developed a mathematical programming technique to estimate the load distribution and optimal amount of profile modification of spur and helical gears. In these studies, the deflection of gear teeth was estimated from that of thin cantilever plates of uniform thickness. Niemann and Reister<sup>(4)</sup> proposed an experimental formula for the factor of spur gears. The authors<sup>(5,6)</sup> solved some problems of the load distribution

using the finite element method (FEM). Although the papers involve many interesting results, they are not sufficient for wide application to designing of gears for strength.

This article summarizes, from a design point of view, the analysis and the results and proposes a formula for the longitudinal load distribution factor for straddle- and overhang-mounted steel spur gears. The deflection of gear teeth is calculated by FEM based on plate theory including the effect of transverse shear deformation. Gears dealt with in this article are generated by the basic rack (pressure angle  $20^\circ$ ; top clearance 0.25m; and radius of tip corner 0.375m) recommended in JIS B 1701-1973 as well as in ISO 53-1974. Finally the determination of the optimal amount of the arc-shaped crowning and the effect of the crowning on the reduction of  $K_{H\beta}$  of spur gears with effective lead error are presented.

## Fundamental Equations

A pair of straddle- or overhang-mounted spur gears (Fig. 1), which are in mesh at the highest point of single tooth contact of pinion, is taken as the typical example of calculation. Each tooth is regarded as a cantilever plate of varying thickness, and it is divided into 10 (in the direction of tooth height) by 20 (in the direction of face width) rectangular elements to analyze by FEM.<sup>(7)</sup> If  $b_1 \neq b_2$ , tooth 2 is divided into  $10 \times 24$  elements so that teeth 1 and 2 can come in contact at the 21 nodes.

When a unit normal load is applied to node  $i$  of gear  $k$  ( $k = 1, 2$ , corresponding to pinion and gear, respectively), the deflection at node  $j$ ,  $w_{i,j}^{(k)}$ , in the direction of the line of action can be determined as the sum of the deflection of the

## AUTHORS:

**TOSHIMI TOBE** was a member of the Department of Precision Engineering at Tohoku University until his retirement in 1985. He spent much of his professional life studying the strength of gears, both at Tohoku University, where he earned his doctorate, and under Prof. G. Niemann at Munich Technical University in Germany.

**KATSUMI INOUE** is an associate professor in the Department of Precision Engineering at Tohoku University. He earned his doctorate in engineering from the university in 1977 and had worked extensively with Dr. T. Tobe on gear strength problems.

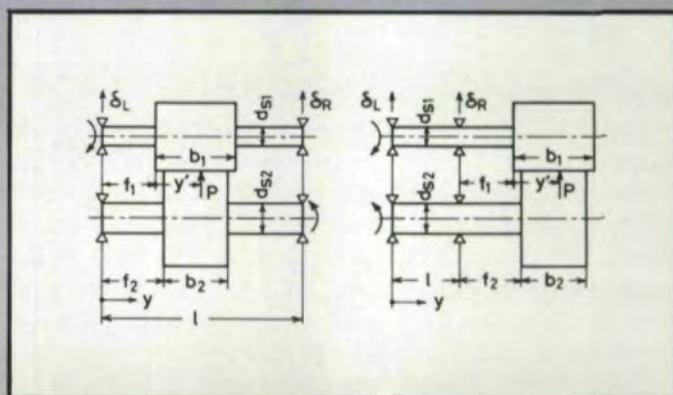

Fig. 1 - Schematics of straddle-mounted and overhang-mounted spur gears.

tooth and the additional displacement due to the bending and torsional deflection of gear bodies and shafts obtained by Equations (A.1) to (A.4) in the Appendix. Introducing matrix  $[H_{(k)}]$ , which is defined by  $w_{i,j}^{(k)}$ , in the following form

$$[H_{(k)}] = [W_1^{(k)}, W_2^{(k)}, \dots, W_{21}^{(k)}] \quad (1)$$

where

$$\{W_1^{(k)}\} = (w_{i,1}^{(k)}, w_{i,2}^{(k)}, \dots, w_{i,21}^{(k)})^T$$

and  $(\dots)^T$  is a transposed matrix. Any distributed load  $\{p^{(k)}\}$  along the contact line is related to the deflection  $\{w^{(k)}\}$  at each node according to the equation

$$[H^{(k)}] \{p^{(k)}\} = \{w^{(k)}\}. \quad (2)$$

When these teeth are engaged, a certain distributed load  $\{p\}$  arises along the contact line and necessarily  $\{p^{(1)}\} = \{p^{(2)}\}$ . Then the relation between the load distribution and accompanying deflection including relative approach can be represented by the following equation

$$[H] \{p\} = \{w\} \quad (3)$$

where the elements of matrices  $[H]$  and  $\{w\}$  are given by

$$H_{i,j} = H_{i,j}^{(1)} + H_{i,j}^{(2)} + \delta_{ij}(w_i^P/p_i)$$

$$w_i = w_i^{(1)} + w_i^{(2)} + w_i^P \quad (4)$$

where  $\delta_{ij}$  is Kronecker's delta,  $p_i$  is the element of  $\{p\}$  and  $w_i^P$  is the relative approach of teeth due to elastic contact.

The equilibrium equation and the condition of contact are given by

$$\sum_{i=1}^{21} p_i = p_n \quad (5)$$

$$w_i + (s_i/1000) = r_{g1}\theta_1 + r_{g2}\theta_2 \quad (\text{contact}) \quad (6)$$

$$p_i = 0 \quad (\text{non-contact})$$

where  $\theta$  is the rotating angle of gears and  $s_i$  is the spacing at the node  $i$  caused by the effective lead error and any crowning. The load distribution  $\{p\}$  can be determined from Equation (3) under the conditions in (5) and (6).

The relative approach is estimated in this article by applying Lundberg's formula<sup>(8)</sup> to the virtual cylinders with the same length as the face width.

#### Comparison of FEM Solutions With the Experimental Formula by Niemann and Reister

The load distribution and the maximum load intensity  $p_{\max}$  of the gears used in the experiment are shown in Fig. 2. The deformation of shafts, bearings and housing is neglected in the FEM calculation because the data are not given in their article. The results obtained by FEM are very close to the results obtained by their experimental formula over the load range of 20.6 to 345.2 N/mm.  $p_{\max}$  obtained by FEM is close to the value calculated by the AGMA strength rating formula (9) (where stiffness is assumed to be  $G = 1.2 \times 10^6$  lb/in<sup>2</sup> [10]) under the heavy transmitted load. On the other

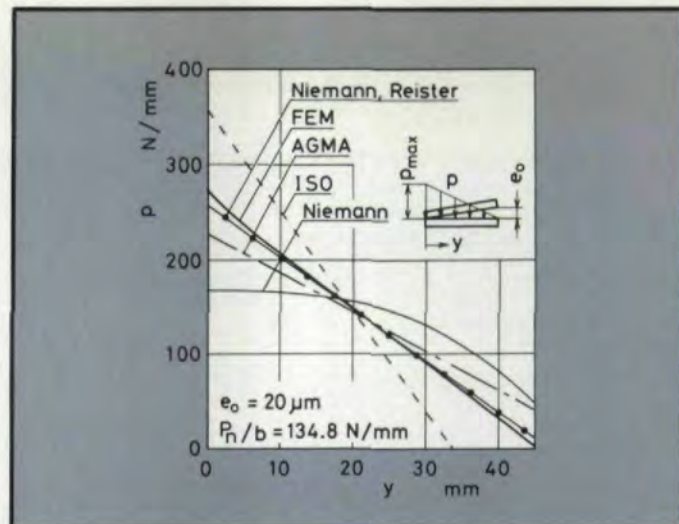

Fig. 2a—Comparison of the load distribution.

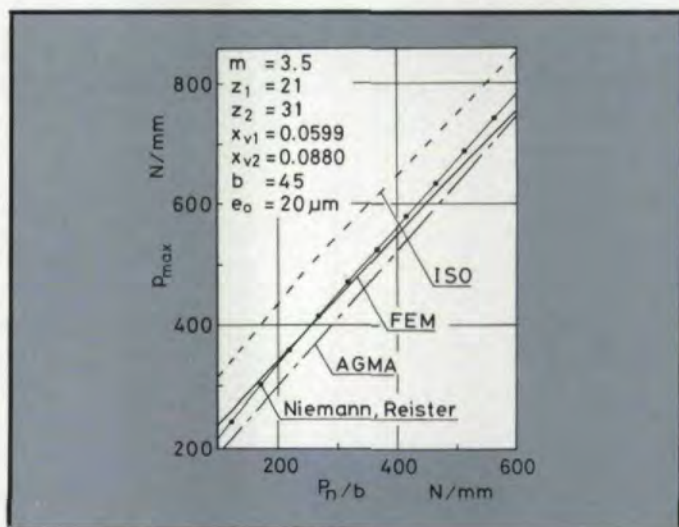

Fig. 2b—Comparison of the maximum load intensity.

hand, the ISO strength rating formula (1) overestimates  $p_{\max}$  about 49 to 8.4 per cent in comparison with the experimental formula.

#### Longitudinal Load Distribution Factor

*Empirical Formula for Longitudinal Load Distribution Factor.* In this section, the longitudinal load distribution factor

$$K_{H\beta} = \frac{p_{\max}}{p_{\text{mean}}} \quad \text{where } p_{\text{mean}} = \frac{P_n}{b} \quad (7)$$

is calculated and a formula for the factor is proposed.

$K_{H\beta}$  neglecting the effect of shaft stiffness. The longitudinal load distribution factor is affected by the total stiffness. To simplify the effect of the total stiffness on the load distribution, it is assumed in this article that the formula for  $K_{H\beta}$  may be represented as the product of two terms: one is the longitudinal load distribution factor of the pair of standard gears  $z_1:z_2 = 18:18$ , and the other is the modification factor of the gear ratio and the addendum modification.

The longitudinal load distribution factor  $K_{H\beta}$  for the standard gears  $z_1:z_2 = 18:18$  is shown in Fig. 3. The calculation was performed for the various combinations of the tooth dimension:  $m = 2.5$  to  $10$  mm and  $b = 30$  to  $120$  mm, and the transmitted load  $P_n/b = 100$  to  $600$  N/mm. From these results, the following empirical formula was derived.

$$[K_{H\beta}]_{z_1:z_2=18:18} = 1.00 + \chi(e_o/b)^{0.95} \quad (8)$$

where  $\chi$  is evaluated by the following equation.

$$\chi = \{3.26(b/m) + 8.00\} (P_n/bm)^{-0.87} \quad (9)$$

The influence of the gear ratio and the addendum modification on  $K_{H\beta}$  is then examined and the following formula is obtained.

$$K_{H\beta} = \{1.00 + \chi(e_o/b)^{0.95}\} \{1.00 + \phi(e_o/b)^{0.5}\} \quad (10)$$

The second factor of Equation (10) is the modification factor. This accounts for the effects of the gear ratio and the addendum modification on  $K_{H\beta}$ , where  $\phi$  is found from Fig. 4 as a function of  $b/m$  and  $\gamma$ . An example of the stiffness ratio  $\gamma$  is shown in Fig. 5 where every pair of gears is engaged at the pitch point. In this figure, total stiffness  $k$  is calculated by the empirical formula of the tooth deflection obtained by two-dimensional FEM<sup>(11)</sup> and by Lundberg's formula when  $m = 5$ ,  $b = 60$  and  $P_n/b = 400$  N/mm.

Although the value of total stiffness  $k$  depends on  $m$ ,  $b$  and  $P_n/b$ , the stiffness ratio  $\gamma$  does not vary so much, and Fig. 5 may be valid for common gears. The error of Equation (10) is about three per cent.

An example of the effect of the difference of the face width  $\Delta b = b_1 - b_2$  on  $K_{H\beta}$  is shown in Fig. 6, where the gears are  $z_1:z_2 = 18:40$  and  $b_2 = 60$ .

$K_{H\beta}$  including the effect of shaft stiffness. Examples of longitudinal load distribution factor of both straddle- and overhang-mounted spur gears are shown in Fig. 7, where the elastic deformation of bearings and housing is neglected. In

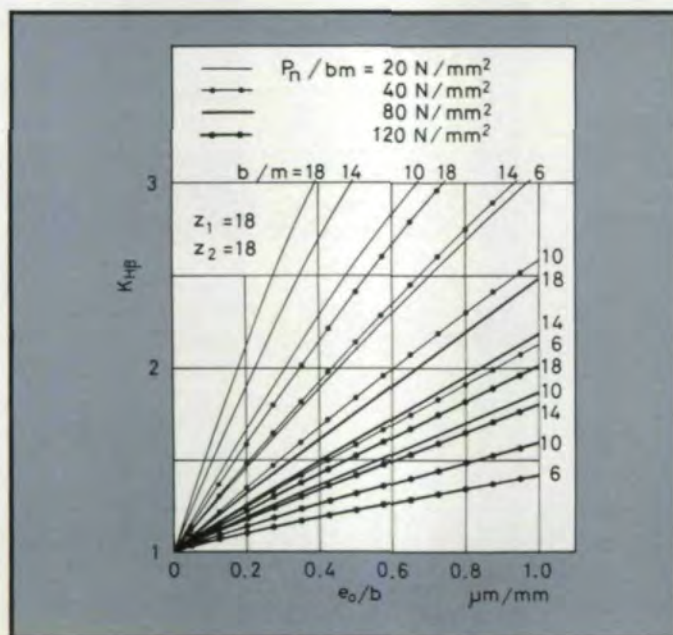

Fig. 3—Longitudinal load distribution factor of standard gears  $z_1:z_2 = 18:18$ ,  $b = b_1 = b_2$  (Deformation of gear bodies and shafts are neglected.)

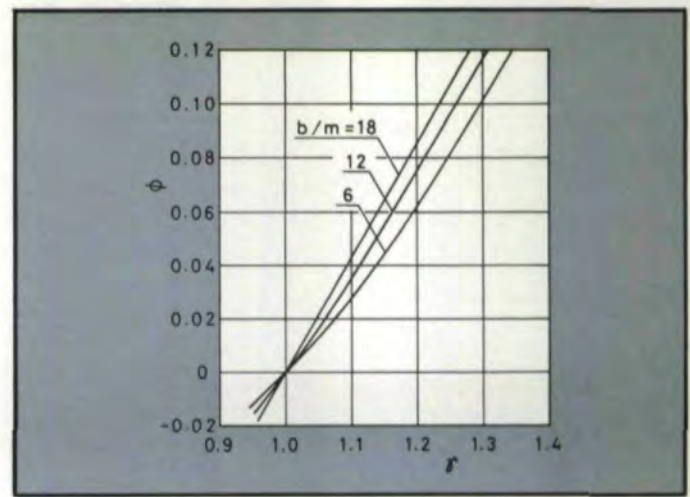

Fig. 4—Coefficient  $\phi$ .

#### Nomenclature

- $b$  = face width of gear tooth (mm)
  - $c$  = distance from the side edge of tooth to the center of arc-shaped crowning (mm)
  - $d_s$  = diameter of shaft (mm)
  - $e$  = amount of crowning ( $\mu\text{m}$ )
  - $e_o$  = effective lead error under no-load ( $\mu\text{m}$ )
  - $e_{eq}$  = equivalent effective lead error ( $\mu\text{m}$ )
  - $k$  = total stiffness of a pair of gears, consisting of the deflection of teeth in mesh and the relative approach [N/(mm  $\mu\text{m}$ )]
  - $K_{H\beta}$  = longitudinal load distribution factor for contact stress
  - $K_{M\beta}$  = bending moment distribution factor
  - $m$  = module (mm)
  - $p$  = load intensity or distributed load per unit length along the contact line (N/mm)
  - $P_n$  = transmitted normal load (N)
  - $r_g$  = base radius (mm)
  - $s$  = spacing between tooth surfaces ( $\mu\text{m}$ )
  - $w$  = deflection of tooth or deflection of shaft (mm)
  - $\bar{w}_b$  = mean displacement of gear caused by the bending deflection of shaft due to uniformly distributed unit load ( $\mu\text{m}/\text{N}$ )
  - $\Delta w$  = displacement difference between the side edges of gear caused by the deflection of shaft due to uniformly distributed unit load ( $\mu\text{mm}/\text{N}$ )
  - $x_p$  = distance from the root to the meshing position along the tooth height (mm)
  - $x_v$  = addendum modification coefficient
  - $z$  = number of gear teeth
  - $\gamma$  = ratio of total stiffness of a pair of gears to that of the pair of standard gears  $z_1:z_2 = 18:18$
  - $\eta^*$  = position of the point where crowned teeth come into contact (mm)
  - $\xi$  = bending moment reduction coefficient
- Suffixes 1 and 2 represent pinion and gear, respectively.

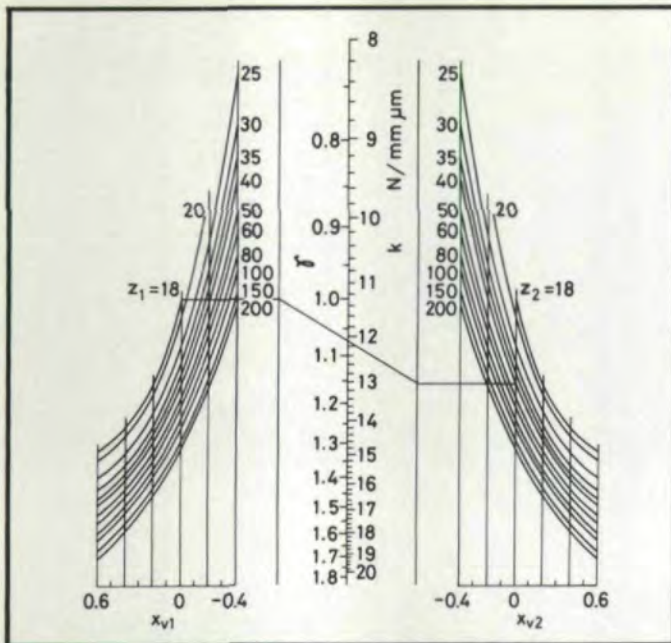

Fig. 5—Total stiffness  $k$  and stiffness ratio  $\gamma$  for gears of  $m = 5$ ,  $b = 60$  and  $P_n/b = 400 \text{ N/mm}$  (Example:  $z_1 = 18$ ,  $x_{v1} = 0$ ,  $z_2 = 40$ ,  $x_{v2} = 0$ ;  $k = 12.08 \text{ N/mm } \mu\text{m}$ ,  $\gamma = 1.07$ ).

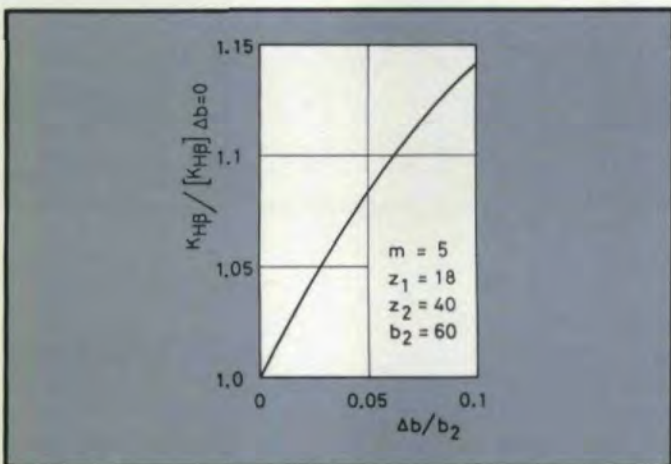
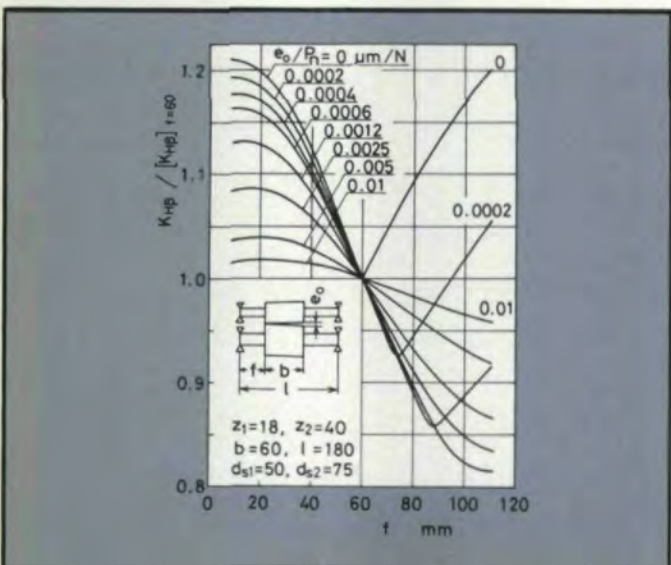

Fig. 6—Example of the influence of the difference of face width  $\Delta b$  on  $K_{H\beta}$ .



these cases, the deflection of the shafts exerts a great influence on longitudinal load distribution factor. When the spacing between tooth surfaces increases because of the deflection of the shafts the factor  $K_{H\beta}$  increases, and vice versa. The turnings of the curves in these figures are caused by both the compensation of the initial lead error and the inversion of the direction of the lead error by the deflection of the shafts.

It is essential, therefore, to find the equivalent effective lead error  $e_{eq}$  under loading. Therefore, the standard gear  $z_1:z_2 = 18:18$  was again adopted, and the longitudinal load distribution factor  $K_{H\beta}$  for both straddle- and overhang-mounted gear with the shafts of various length and diameter was calculated. The value of  $K_{H\beta}$  obtained, was substituted in Equation (8), and the value of lead error  $e_0$  in the equation, namely, the equivalent effective lead error  $e_{eq}$ , was estimated. In most strength rating formulas, the error  $e_0'$ , which is the sum of the effective lead error  $e_0$  under no-load, and the displacement difference  $\Delta w$  between the side edges of the gears due to the deflection of the shafts,

$$e_0' = e_0 + (\Delta w_1 + \Delta w_2) P_n \quad (11)$$

is used as the equivalent lead error to calculate the longitudinal load distribution factor. The error  $e_0'$  is, however, larger than the equivalent lead error  $e_{eq}$  estimated above, except for the very rigid mounting. The relation between  $e_{eq}$  and  $e_0'$  is expressed by the following equation.

$$e_{eq} = |e_0'|^\chi \quad (12)$$

Coefficient  $\chi$  is shown in Fig. 8. Consequently, when the equivalent effective lead error  $e_{eq}$  is estimated by Equations (11) and (12), the longitudinal load distribution factor  $K_{H\beta}$  is evaluated by the following formula:

$$K_{H\beta} = \{1.00 + \chi(e_{eq}/b)^{0.95}\} \{1.00 + \phi(e_{eq}/b)^{0.5}\} \quad (13)$$

Equation (13) was tested for other pairs of gears. Its error is about six per cent, unless mountings of small rigidity or extreme asymmetry are used.

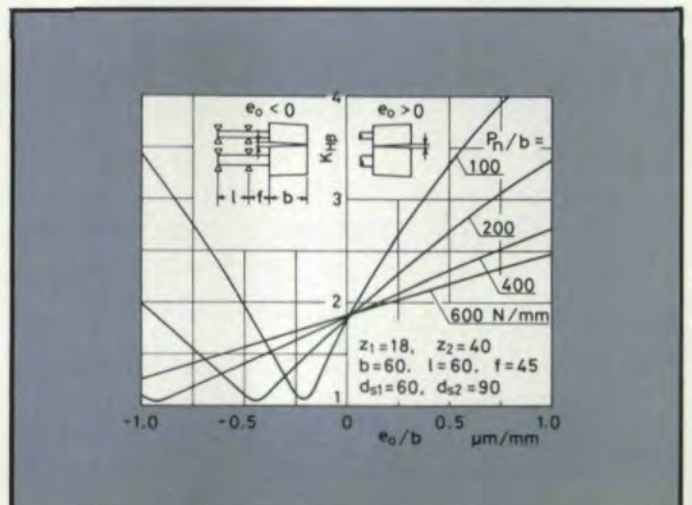

Fig. 7a & 7b—Examples of longitudinal load distribution factor for straddle-mounted (left) and overhang-mounted gears (right).



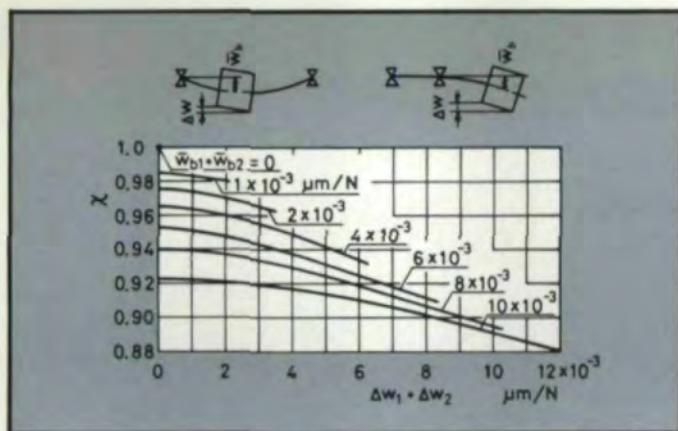

Fig. 8—Coefficient  $\chi$ .

Table 1 Dimensions of gears (straddle-mounted)

	gear 1	gear 2
$m$	5	
$z$	18	40
$x_v$	0	0
$b$	60	60
$1$	180	
$f$	40	40
$d_s$	50	75

Table 2 Comparison of longitudinal load distribution factor  $K_{H\beta}$

$P_r/b$ (N/mm)	FEM			Formula (13)			ISO			AGMA ( $K_m$ )		
	200	400	600	200	400	600	200	400	600	200	400	600
$e_o = 0 \mu\text{m}$	1.19	1.20	1.20	1.15	1.15	1.16	1.25	1.25	1.25	1.18	1.18	1.18
15 $\mu\text{m}$	1.39	1.15	1.07	1.36	1.13	1.05	1.69	1.22	1.06	1.33	1.16	1.08
30 $\mu\text{m}$	1.89	1.41	1.24	1.78	1.37	1.22	2.55	1.69	1.37	1.61	1.33	1.22

#### Comparison of $K_{H\beta}$ with the Values in ISO and AGMA\*

Taking the example started in Table 1,  $K_{H\beta}$  values are compared in Table 2. The factor  $K_{H\beta}$  using the Formula (13) is very close to the calculated values. ISO formula give 10 to 30 per cent larger values except for the case of small lead error. The AGMA formula gives fairly close values of  $K_m$  as a whole. The lead error  $e_o'$  was used in the calculation of  $K_{H\beta}$  in ISO and  $K_m$  in AGMA. The fundamental formulas for the factor in ISO and AGMA are same, but the values of the mesh stiffness are different. The stiffness  $c_y = c'(0.75\epsilon_\alpha + 0.25)$ , recommended in ISO<sup>(1)</sup>, is about 2.8 times the stiffness  $G$  in AGMA<sup>(10)</sup> and is about 2 times the stiffness  $k$  obtained by our finite element analysis.<sup>(11)</sup> This is the reason that the ISO formula gives large  $K_{H\beta}$  as compared with the AGMA formula and the proposed Formula (13).

#### Bending Moment Distribution Factor

The plate theory gives more gentle distribution of bending moment at the root than the beam theory, and the effect is represented by the coefficient  $\xi$  defined as follows:

$$\xi = \frac{M_{x, \max}}{M_{x, 0}} = \frac{M_{x, \max}}{P_{\max} \cdot l_p} \quad (14)$$

where  $M_{x, \max}$  and  $M_{x, 0}$  are the maximum bending moment at the root calculated by the plate theory and by the beam theory, respectively, and  $l_p$  is the length of moment arm. The

\*Details shown in Appendix B.



**ASME Gear Research Institute**

(A Public Non-Profit Activity)

**RESEARCH** — Conducts and Manages Research, Develops Proposals, Evaluates Research Needs, Locates Research Facilities.

**MEMBERSHIP** — Corporate and Individual — Task Forces, Program Input, Program Sponsors, Steering Committees, etc.

**EDUCATION** — Conferences, Short Courses, Publications, Program Sponsors Meetings, Translations.

**AFFILIATES** — Directory of Experts, Problem Solving, Information Source, Program Management.

**Write or Call For Information on Membership**

**LOCATION:** N. Washington & East-West Tollway  
Post Office Box 353  
Naperville, IL 60566  
312/355-4200

CIRCLE A-7 ON READER REPLY CARD

bending moment distribution factor  $K_{M\beta}$  is defined as follows:

$$K_{M\beta} = \frac{M_{x, \max}}{M_{x, \text{mean}}} = \frac{M_{x, \max}}{P_n/b} l_p \quad (15)$$

If the loading position and the root location adopted in this article and in ISO are same,  $K_{M\beta}$  in our definition may be equal to  $K_{F\beta}$  in the formula of ISO.\*\* From Equations (14) and (15),  $K_{M\beta}$  is derived as follows:

$$K_{M\beta} = \xi K_{H\beta} \quad (15')$$

For standard gears  $z_1:z_2=18:18$  engaged at the highest point of single tooth contact of gear 1, the calculated coefficient  $\xi$  of gear 1,  $\xi_o = [\xi]_{z_1:z_2=18:18}$ , is shown in Fig. 9. Using this result, the coefficient  $\xi$  of any gears can be approximately estimated by the following equation:

$$\xi = 1.00 - (1.00 - \xi_o) \frac{X_p/m}{1.59} \quad (16)$$

The value 1.59 indicates  $X_p/m$  of the gear 1 mentioned above. The value of  $\xi$  obtained by Equation (16) is valid to estimate the bending moment distribution factor  $K_{M\beta}$  of both straddle- and overhang-mounted gears without any crowning.

#### Total Stiffness of Gears with Effective Lead Error

When a pair of gears with effective lead error is in mesh, the maximum deflection at the meshing position is larger than the deflection of the same gears without lead error.

The total stiffness, which is defined in this article as the ratio of the transmitted load and the maximum deflection, decreases with the increase of the effective lead error or  $K_{H\beta}$ , as shown in Fig. 10. In these cases, the relative approach estimated from Lundberg's formula is included and the deflection of shafts is neglected. In the case of  $K_{H\beta} = 1$ , the stiffness is about six to twelve per cent larger than the stiffness which is estimated by two-dimensional FEM.<sup>(11)</sup> The empirical formula is obtained from Fig. 10 as follows:

$$k = (P_n/b)/[w_1 + w_2 + w^p]_{\max}$$

$$k = K_{H\beta}^{-0.96} [k]_{K_{H\beta}=1} \quad (17)$$

#### Optimal Amount of Crowning

To minimize the longitudinal load distribution factor of a pair of gears with effective lead error  $e_{eq}$ , this section determines the optimal amount of arc-shaped crowning. The center of the curvature of the crowning is assumed to lie between the side edges of the tooth.

Referring to Fig. 11, the total spacing between tooth sur-

\*\* $K_{F\beta}$  is the longitudinal load distribution factor for bending stress in ISO<sup>(1)</sup> and accounts for the effect of load distribution across the face width on the bending stress at the tooth root. It is given by the following equation:

$$K_F = K_H^N$$

$$N = \frac{(b/h)^2}{1+b/h+(b/h)^2}$$

$b/h$  = ratio of face width to tooth height, the minimum of  $b_1/h_1$  or  $b_2/h_2$

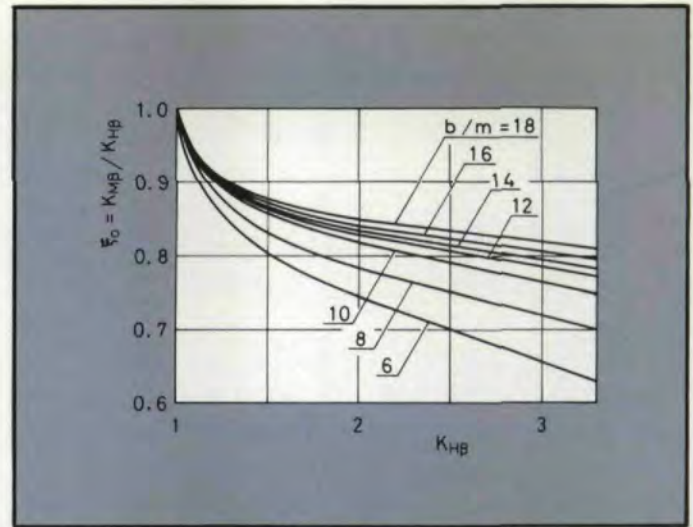

Fig. 9—Coefficient  $\epsilon_o$  for the calculation of  $K_{M\beta}$ .

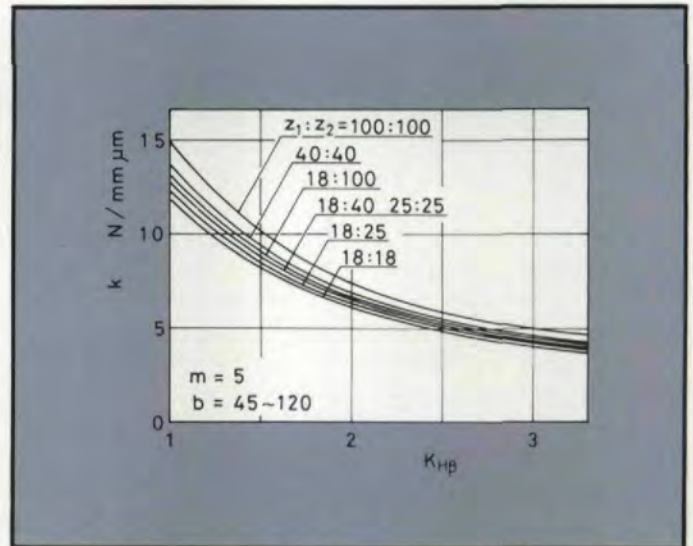

Fig. 10—Total stiffness of a pair of spur gears with effective lead error.

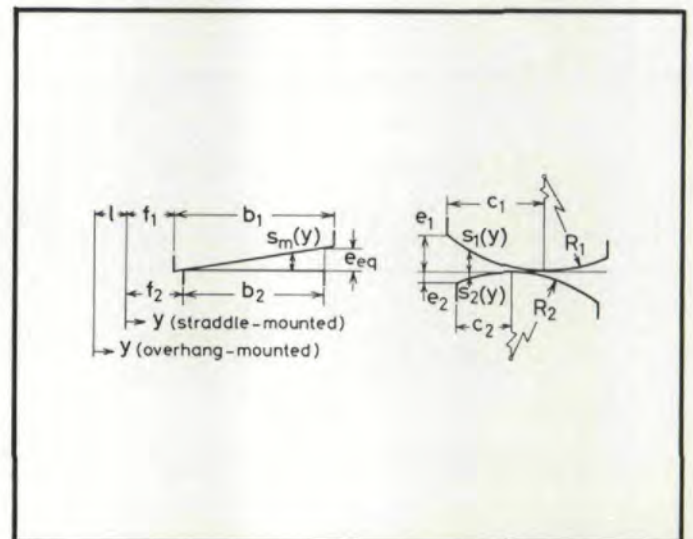

Fig. 11—Spacing between tooth surfaces caused by the effective lead error (left) and the crowning (right).

faces due to the lead error and the crowning is expressed in the following form;

$$s_o(\eta) = s_m(\eta) + s_1(\eta) + s_2(\eta)$$

$$= e_{eq} \frac{\eta - f_2}{b_2} + e_1 \frac{(f_1 - c_1 - \eta)^2}{c_1} + e_2 \frac{(f_2 - c_2 - \eta)^2}{c_2} \quad (18)$$

where  $\eta = y$  for straddle-mounted gears  
 $\eta = y - 1$  for overhang-mounted gears.

When both tooth surfaces just come into contact at  $\eta = \eta^*$ , the position  $\eta^*$  is obtained from

$$\frac{ds_o(\eta)}{d\eta} \Big|_{\eta=\eta^*} = 0$$

as follows:

$$\eta^* = \dots \quad (19)$$

The spacing  $s(\eta)$  is therefore obtained by subtracting the minimum of  $s_o$  from  $s_o(\eta)$  and represented in the following expression.

$$s(\eta) = s_o(\eta) - s_o \text{ min}$$

$$= s_o(\eta) - s_o(\eta^*)$$

$$= \frac{1}{c_1^2 c_2^2 (e_1 c_2^2 + e_2 c_1^2) + e_2 (f_2 + c_2) c_1^2 - \frac{c_1^2 c_2^2 e_{eq}}{2b_2}} [(e_1 c_2^2 + e_2 c_1^2) \eta - \{e_1 (f_1 + c_1) c_2^2 + e_2 (f_2 + c_2) c_1^2 - \frac{c_1^2 c_2^2 e_{eq}}{2b_2}\}]^2 \quad (20)$$

To locate the maximum load intensity at the required position  $\eta = \eta^*$ , the shapes of crowning of both pinion and gear,  $(e_1, c_1)$  and  $(e_2, c_2)$ , should satisfy the following equation, which is derived from Equation (19).

$$e_1 c_2^2 (f_1 + c_1 - \eta^*) + e_2 c_1^2 (f_2 + c_2 - \eta^*) - \frac{c_1^2 c_2^2 e_{eq}}{2b_2} = 0 \quad (21)$$

And to minimize the longitudinal load distribution factor for the given value of  $\eta^*$ , the coefficient of  $\eta^2$  in the Equation (20), namely,

$$e_1/c_1^2 + e_2/c_2^2 \quad (22)$$

has to be minimized.

For example, the longitudinal load distribution of the pair of gears studied in Table 1 is shown in Fig. 12. In this calculation, only pinion is given the arc-shaped crowning listed in Table 3. The solid curves 1,2,3 and 4 in Fig. 12 show the load distribution of the gears with the optimal amount of crowning. The maximum load  $p_{max}$  is reduced about 40 per cent as compared with  $p_{max}$  of the gears without crowning. On the other hand, the load distribution of the gears with the larger value of  $e_1/c_1^2$  is not so reduced. Note the broken curves in Fig. 12.

Although the method above determines the optimal amount of crowning, it requires  $\eta^*$ , and it is not easy to determine  $\eta^*$  to minimize the longitudinal load distribution factor. Another simple method is needed to estimate the optimal

## GEAR UP AND DO BUSINESS

Competition is stiff! In today's tough gear market, you need the latest know-how and the best tools to be truly competitive. See what it takes to do business...

October 4-7, 1987, Cincinnati, Ohio

### THE AMERICAN GEAR MANUFACTURERS ASSOCIATION FALL TECHNICAL MEETING AND GEAR EXPO

#### THE FALL TECHNICAL MEETING October 6-7, 1987

Top engineers from the world's leading gearing centers present the latest in two intense days of plenary sessions. The FTM is an opportunity to share ideas with these experts on a wide variety of gear subjects. The meeting format encourages an active exchange of ideas, with plenty of time for questions and attention to your individual technical interests. Sessions will be devoted to:

Geometry  
 Bevel Gearing  
 Rating and Loads  
 New Inspection Techniques  
 Wear and Materials  
 New Manufacturing Processes



#### GEAR EXPO '87 October 4-6, 1987

The largest show ever conceived entirely for the gear industry. Browse through the 100+ booths designed to provide you maximum information in minimum time. The wide range of suppliers and manufacturers invites you to make comparisons right on the show floor. You and the exhibitors are all there for the same reason — to increase your competitive edge in today's tough market. See hardware in operation, such as:

Grinders and Hobbors  
 Inspection Equipment  
 Design and Inspection Software  
 Broaches and Tooling  
 Materials and Components  
 Specialty Services



CIRCLE A-4 ON READER REPLY CARD

**Table 3 Shapes of crowning ( $e_1, c_1$ ) and  $K_{H\beta}$  of gears shown in Table 1**  
 ( $P_n/b = 200\text{N/mm}$ ,  $e_o = 20\mu\text{m}$ ,  $e_{eq} = 26.18\mu\text{m}$ )

Case	$\eta^* - f_1$	$c_1/b$	$e_1/e_{eq}$	$(e_1/c_1^2)/(e_{eq}/b^2)$	$K_{H\beta}$
1	12	1.0	0.625	0.625	1.14
2	18	1.0	0.714	0.714	1.12
3	24	1.0	0.833	0.833	1.12
4	30	1.0	1.0	1.0	1.14
1'	12	0.45	0.405	2.0	1.51
2'	18	0.55	0.605	2.0	1.39
3'	24	0.65	0.805	2.0	1.31
4'	30	0.75	1.125	2.0	1.29

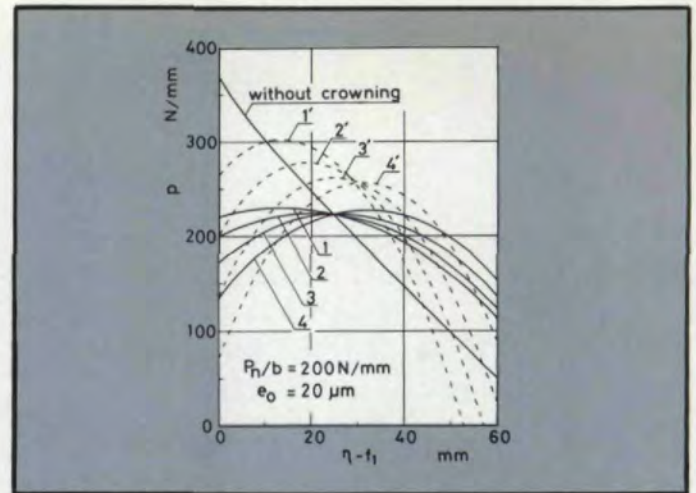

Fig. 12—Longitudinal load distribution of the gears with the arc-shaped crowning in Table 3.

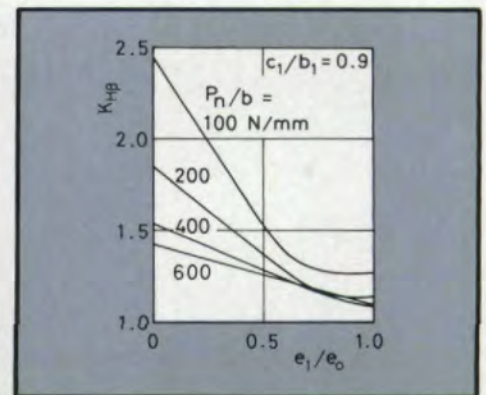
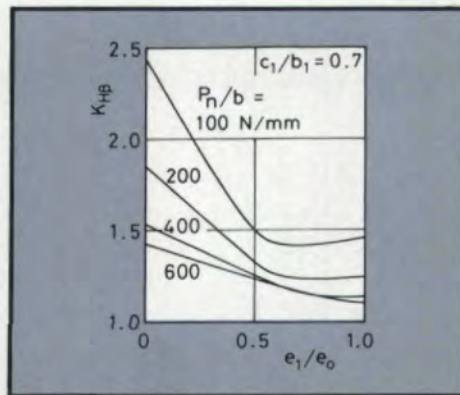
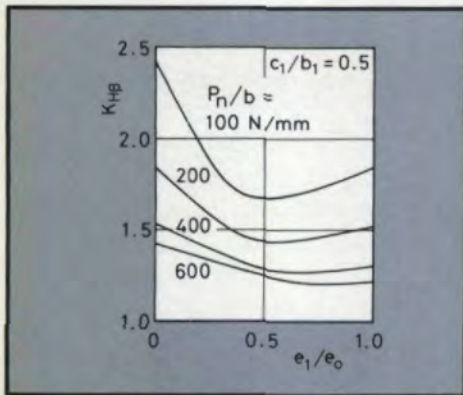

Fig. 13—Longitudinal load distribution factor of straddle-mounted gears with the arc-shaped crowning ( $m = 5$ ,  $z_1:z_2 = 18:40$ ,  $b = b_1 = b_2 = 60$ ,  $l = 180$ ,  $f_1 = f_2 = 40$ ,  $d_{a1} = 50$ ,  $d_{a2} = 75$ ,  $e_o = 20\mu\text{m}$ ).

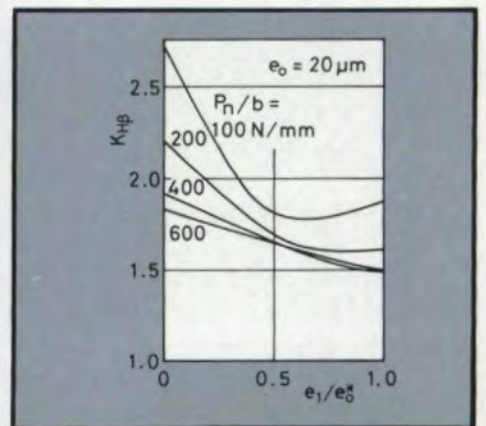
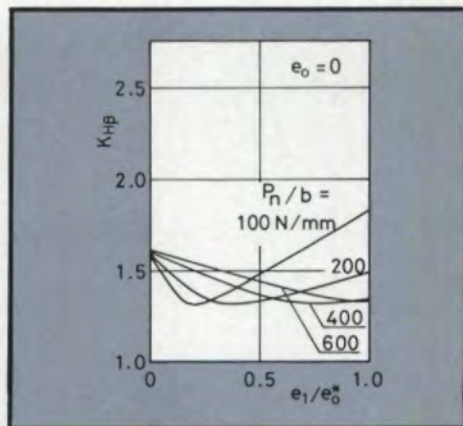
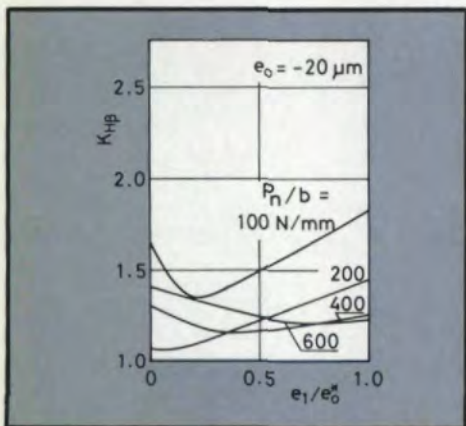

Fig. 14—Longitudinal load distribution factor of overhang-mounted gears with the arc-shaped crowning ( $m = 5$ ,  $z_1:z_2 = 18:40$ ,  $b = b_1 = b_2 = 60$ ,  $l = 60$ ,  $f_1 = f_2 = 30$ ,  $d_{a1} = 60$ ,  $d_{a2} = 90$ ,  $c_1/b_1 = 0.5$ ,  $e_o = 20\mu\text{m}$ ).

amount of crowning without  $\eta^*$ . Fig. 13 and Fig. 14 show some results of  $K_{H\beta}$ , where only pinion is crowned with various amount of crowning  $e_1$ . From these results, the relation between the optimal amount of crowning and the equivalent lead error  $e_{eq}$  is obtained as follows:

$$e_{1\text{ opt}}/e_{eq} = 0.92(c_1/b_1) \quad (23)$$

If the position of the center of crowning is given, the optimal amount of crowning  $e_{1\text{ opt}}$  can be found from Equation (23).

When the equivalent effective lead error  $e_{eq}$  is adopted instead of the error  $e_o$ , ISO recommendation for the crowning, or  $c/b = 0.5$  and  $e/e_{eq} = 0.5$ , is reasonable to minimize  $K_{H\beta}$  approximately  $c/b = 0.5$ .

Some results of  $K_{H\beta}$  and  $\xi$  of both straddle- and overhang-

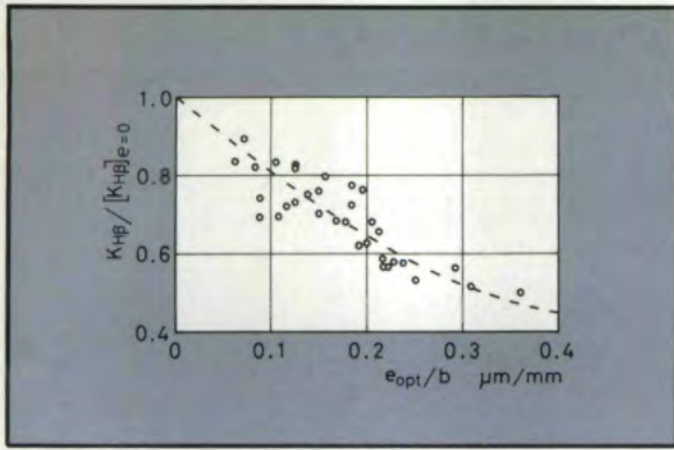

Fig. 15a— $K_{H\beta}$  of the gears with the optimal crowning.

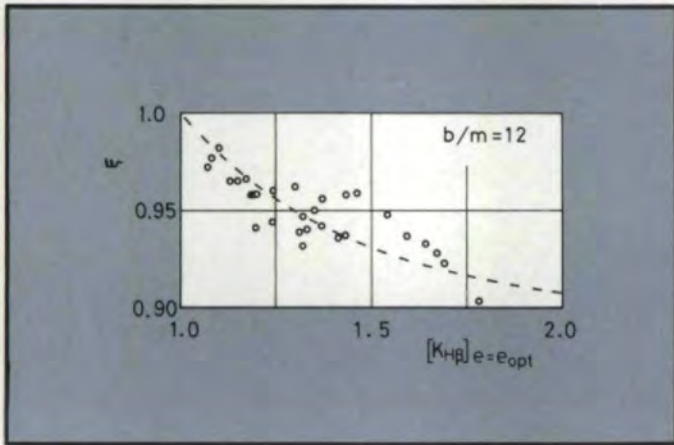

Fig. 15b— $\epsilon$  of the gears with the optimal crowning.

mounted gears with the optimal amount of crowning are plotted in Fig. 15. The pair of gears used in these calculations is  $m = 5$ ,  $z_1:z_2 = 18:40$ . The bending moment distribution at the root of gears with the optimal crowning is nearly uniform. (See Fig. 15)

### Conclusion

Longitudinal load distribution and bending moment distribution at the root are calculated for the straddle- and the overhang-mounted spur gears.

The longitudinal load distribution factor  $K_{H\beta}$ , the bending moment distribution factor  $K_{M\beta}$  and the total stiffness  $K$  are given in the illustrations. A formula for the estimation of  $K_{H\beta}$  is proposed. The formula is very useful to estimate  $K_{H\beta}$  of spur gears whose effective lead error can be evaluated. When  $K_{H\beta}$  is compared with the values calculated by ISO and AGMA formulas, the load distribution factor  $K_m$  obtained by AGMA formula is fairly close to  $K_{H\beta}$  in our calculation.

A method is proposed to determine the optimal amount of arc-shaped crowning of spur gears with the effective lead error. The ISO recommendation for the determining of optimal crowning is reasonable, and it approximately minimizes the longitudinal load distribution factor.

### Appendix A:

#### [I] Straddle-mounted

##### (1) Bending deflection

$$w_b = -\frac{K}{6} \frac{1-(f+y')}{1} p_n y^3 + a_1 y + a_2 \quad (f \leq y \leq f+y')$$

$$w_b = \frac{K}{6} \frac{f+y'}{1} p_n y^3 - \frac{K}{2} (f+y') p_n y^2 + a_3 y + a_4 \quad (f+y' \leq y \leq f+b)$$

$$a_1 = -\frac{K}{2} (f+y')^2 p_n + a_3$$

$$a_2 = \frac{K_S - K}{3} \frac{1-(f+y')}{1} f^3 p_n + \delta_L$$

$$a_3 = \frac{K_S - K}{2} (f+b) (f+y') \frac{(f+b-2)}{1} p_n + a_5$$

$$a_4 = -\frac{K}{6} (f+y')^3 p_n + a_2$$

$$a_5 = \frac{K_S}{3} (f+y') p_n - \frac{a_6}{1} + \frac{\delta_R}{1}$$

$$a_6 = \frac{K_S - K}{6} (f+b)^2 (f+y') \frac{(2f+b-3)}{1} p_n + a_4$$

(A.1)

##### (2) Torsional deflection

$$w_t = [J_S f + J(y-f)] p_n r_g^2 \quad (f \leq y \leq f+y')$$

$$w_t = (J_S f + J y') p_n r_g^2 \quad (f+y' \leq y \leq f+b)$$

(A.2)

#### [II] Overhang-mounted

##### (1) Bending deflection

$$w_b = -\frac{K}{6} p_n y^3 + \frac{K}{2} (1-f+y') p_n y^2 + a_1 y + a_2 \quad (1+f \leq y \leq 1+f+y')$$

$$w_b = a_3 y + a_4 \quad (1+f+y' \leq y \leq 1+f+b)$$

$$a_1 = -\frac{K_S - K}{2} (1+f)^2 p_n + (K_S - K) (1+f+y') (1+f) p_n + a_5$$

$$a_2 = \frac{K_S - K}{3} (1+f)^3 p_n - \frac{K_S - K}{2} (1+f+y') (1+f)^2 p_n + a_6$$

$$a_3 = \frac{K}{2} (1+f+y')^2 p_n + a_1$$

(Continued on page 45)

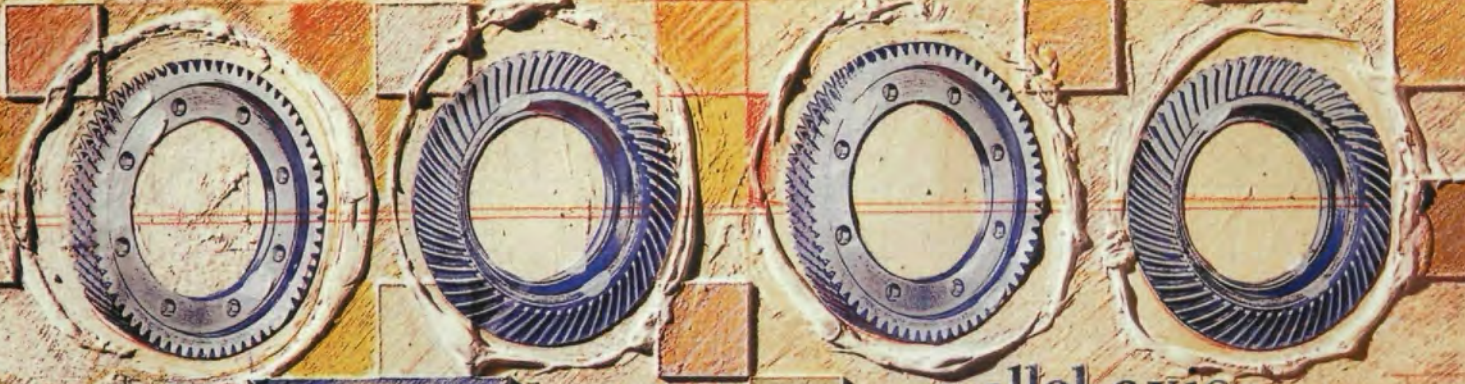

•parallel axis

•SyStems



•bevel



•metrology



CNC



*J. Liddy*

# THERE'S A WHOLE LOT MORE TO MAKING GEARS THAN MAKING GEARS

**Gleason is the only gear machinery producer in the world offering systems and machines for both bevel and parallel-axis gears.**

**And no other company has made a greater commitment to serving your needs in the world of gearing. Here's how.**

## **Gear Cells & Systems**

Automotive, truck, aircraft, machinery and component producers faced with worldwide competition have seen the need to leap decades from present gear production methods to automated systems.

That's why Gleason offers systems. (Gleason is the only company in the world offering manufacturing systems for both bevel and parallel-axis gears.)

Each system is designed for your specific needs and may range from an upwardly integratable flexible machine or cell, to an unmanned system that starts with the raw material and finishes with the completed gear.

## **Gleason Management Services**

To produce gears profitably at lower cost and higher quality in a highly competitive world market involves serious decision making that weighs economic, competitive and technical factors.

That's why Gleason Management Services was formed. We augment your staff to define objectives, evaluate present operations and develop feasible alternatives employing material handling, automation, gear processing, control systems and communication technologies. Better management decisions are the result.

What's more, the Gleason involvement can proceed further, ranging from a simple reorganization of an existing facility to the startup of automated systems.

## **Parallel-Axis Machines**

Introduced a scant six years ago and continually refined, Gleason's hobbers have rendered obsolete virtually all traditional gear manufacturing techniques.

Producing the highest quality spur and helical gears at greatly reduced manufacturing costs, these machines are found in major auto transmission plants worldwide.

They're systems compatible, are CNC controlled and may be equipped with auto hob change, auto part handling and auto fixture changing.

## **Bevel Gear Machinery**

The Gleason commitment to bevel and hypoid gear production has resulted in a continual stream of productive innovations for the gear manufacturer.

Gleason offers major advances in CNC technology to simplify production of bevel and hypoid gears and minimize traditional setup and changeover time.

And versatility takes on new dimensions with the G-MAXX™ generator. . . the first machine to offer face milling and face hobbing. . . with instant changeover.

Gleason's advanced hard finishing. . . includes carbide cutting, conventional and CBN grinding. . . all utilizing CNC controls and capable of systems integration.

## **Metrology**

Gleason G-Age quality assurance machinery and computer software are indispensable for the gear manufacturer. They are designed not only to determine variation from specified dimensional accuracies, but to analyze specific deviations and to identify deviation sources for process control.

Inspection products include single-flank, elemental and a Gleason software/Zeiss CMM combination.

## **Tooling/Workholding**

Gleason cutting tools and workholding components are designed for every process in the production of spur, helical and bevel gears, from turning to finish operations and provide repeatability and quick-change capability for manual and automatic part loading.

## **Time-Share Design Service**

When you have a bevel gear design question, the most effective way to be sure of your final design decisions is simply to tie in, by modem, with the Gleason computer time-share design service.

## **Training**

Gleason provides unique training programs in Rochester that will enhance your ability to design and to make the best use of your gear manufacturing capabilities.

Contact The Gleason Works to discuss your production of the world's best power transmission products. 1000 University Avenue, Rochester, NY 14692, (716) 461-8033 or Detroit (313) 353-5205.

**Gleason**  
**The World of Gearing**

CIRCLE A-14 ON READER REPLY CARD

# Helical Gears With Circular Arc Teeth: Simulation of Conditions of Meshing and Bearing Contact

F. L. Litvin  
Chung-Biau Tsay  
University of Illinois  
at Chicago, IL

## Abstract:

Methods proposed in this article cover: (a) generation of conjugate gear tooth surfaces with localized bearing contact; (b) derivation of equations of gear tooth surfaces; (c) simulation of conditions of meshing and bearing contact; (d) investigation of the sensitivity of gears to the errors of manufacturing and assembly (to the change of center distance and misalignment); and (e) improvement of bearing contact with the corrections of tool settings. Using this technological method we may compensate for the dislocation of the bearing contact induced by errors of manufacturing and assembly. The application of the proposed methods is illustrated by numerical examples. The derivation of the equations is given in the Appendix.

## Introduction

Circular arc helical gears have been proposed by Wildhaber<sup>(10)</sup> and Novikov<sup>(8)</sup> (Wildhaber-Novikov gears). These types of gears became very popular in the sixties, and many authors in Russia, Germany, Japan and the People's Republic of China made valuable contributions to this area. The history of their researches can be the subject of a special investigation, and the authors understand that their references cover only a very small part of the bibliography on this topic.

The successful manufacturing of a new type of gearing depends on the precision of the tool used for the generation of the gears. Kudrjavzev<sup>(3)</sup> in the USSR proposed the application of two mating hobs for the generation of the W-N gears. These hobs were based on the application of two

mating rack cutters, the normal section of each rack cutter representing a circular arc. Tools for the generation of circular arc helical gears have been proposed in West Germany by Winter and Looman.<sup>(11)</sup>

The circular arc helical gear is only a particular case of a general type of helical gear which can transform rotation with constant gear ratio and have a point contact at every instant. Litvin<sup>(4)</sup> and Davidov<sup>(2)</sup> simultaneously and independently proposed a method of generation for helical gears by "two rigidly connected" tool surfaces. We shall, however, limit the discussion to the case of circular arc helical gears.

The purposes of this article are twofold: the simulation of the conditions of meshing and the bearing contact for the misaligned W-N gears (the TCA method), and the adjustment of the gears for the compensation of the dislocation of the bearing contact. The main geometric properties of these gears and the method of their generation are also considered.

The tooth surfaces of circular arc helical gears (W-N gears) are in contact at a point at every instant instead of in contact along a straight line, as is the case with involute helical gears. Due to the elasticity of gear tooth surfaces, the initial contact at a point of circular arc helical gears spreads over an ellipse under the load. In the process of meshing, the center of the contacting ellipse moves over the gear tooth surface along a helix. The line of action is the set of contacting points which is represented in a fixed coordinate system rigidly connected to the frame. The line of action for the Novikov gears is a line which is parallel to the axes of rotation. The gear tooth surfaces may be generated by two rack cutters— $F$  and  $P$ —provided with the generating surfaces  $\Sigma_F$  and  $\Sigma_P$ . We may imagine that surfaces  $\Sigma_F$  and  $\Sigma_P$  are rigidly connected to each other and are in tangency along the straight line  $a-a$  (Fig. 1a). The normal sections of the rack cutters are two circular arcs. While the rack cutters translate with velocity  $v$ , the gears rotate with angular velocities  $\omega^{(1)}$  and  $\omega^{(2)}$ , respectively. Cylinders of radii  $r_1 = v \div \omega^{(1)}$  and  $r_2 = v \div \omega^{(2)}$  are the gear axodes, and plane  $\Pi$ , which is tangent to the cylinders, is the axode of the rack cutters. The line of tangency of the axodes,  $I-I$ , is the instantaneous axis of rotation. Consider that the rack cutter surface  $\Sigma_F$  generates gear 1 tooth surface  $\Sigma_1$  and  $\Sigma_P$  generates gear 2 tooth surfaces  $\Sigma_2$ . Surfaces  $\Sigma_F$  and  $\Sigma_1$  and, correspondingly,

---

## AUTHORS:

FAYDOR L. LITVIN is Professor of Mechanical Engineering at the University of Illinois at Chicago. He is the author of several books and papers on gears and gearing subjects. In addition to his teaching and research responsibilities, Dr. Litvin has served as a consultant to major industrial corporations. He is Chairman of the ASME subcommittee of Gear Geometry and Manufacturing and a member of the ASME Power Transmission and Gearing Committee.

CHANG-BIAU TSAY did his undergraduate work at Taipei Institute of Technology, Taiwan, and earned his master's degree from Illinois Institute of Technology in Chicago. He is presently completing his doctoral work at the University of Illinois at Chicago.



$\Sigma_p$  and  $\Sigma_2$ , are in line contact, but  $\Sigma_1$  and  $\Sigma_2$  are in point contact.

Two hobs and two grinding wheels may also be used instead of two rack cutters for the generation of gears. The design of these tools is based on the idea of application of two rack cutters. The shape of these mating tools depends on the gear pitch only, and the same tools can be used for the generation of mating gears with different combinations of teeth.

Circular arc helical gears have the following advantages over involute helical gears. There are reduced contacting stresses and better conditions of lubrication. The disadvantages of these gears are higher bending stresses due to point contact of the tooth surfaces, sensitivity to the change of the center distance and to the misalignment of axes of gear rotation, and a more complicated tool shape. However, some of these disadvantages can be avoided, and circular arc helical gears may have a certain area of application. The bending stresses can be reduced by appropriate proportions of tooth elements. The effect of dislocation of the bearing contact due to the change of the distance between the gear axes may be reduced by appropriate relations between the principal curvatures of gear tooth surfaces, and may even be compensated for technologically by refinishing one of the gears (the pinion). Fortunately, the change of axes distance does not induce kinematical errors—a deviation of function  $\phi_2$  ( $\phi_1$ ) from the corresponding linear function. The misalignment of gear axes induces kinematical errors of the gear train which

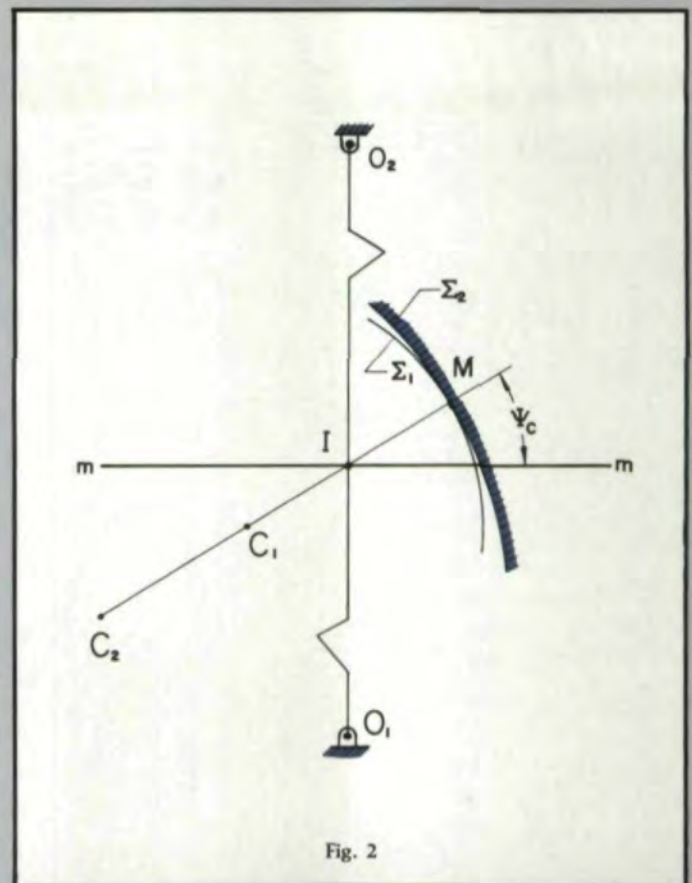

Fig. 2

can exert vibrations of gears. Simultaneously, the misalignment of gear axes also effects a small dislocation of the bearing contact. The effect of misalignment of gear axes can also be compensated for technologically by refinishing of the pinion.

The purpose of this article is to demonstrate the computer-aided simulation and adjustment of the bearing contact and conditions of meshing of circular arc helical gears.

### Main Features

The main advantage of Wildhaber-Novikov gears is based on the fact that helical gears with point contact of the tooth surfaces are free of the restrictions of curvatures that are typical for spur and helical gears which have line contact of the tooth surfaces.

Consider shapes  $\Sigma_1$  and  $\Sigma_2$ , which are the cross sections of spur or helical gears having line contact of the tooth surfaces. Shapes  $\Sigma_1$  and  $\Sigma_2$  are in tangency at point M (Fig. 2). The instantaneous angular velocity ratio is given by

$$m_{12} = \frac{\omega^{(1)}}{\omega^{(2)}} = \frac{O_2 I}{O_1 I} \quad (1)$$

Generally,  $m_{12}$  is not constant and  $m_{12} = f(\phi_1)$  where  $\phi_1$  is the angle of rotation of gear 1. It is known from the *Theory of Gearing*<sup>(5)</sup> that the derivative  $dm_{12}/d\phi_1$  is equal to zero if the following equation is satisfied:

$$\frac{e_2 - e_1}{(e_1 - l)(e_2 - l)} = \frac{\Delta e}{e_1^2 - l(e_1 + \Delta e) + l^2} = \frac{r_1 + r_2}{r_1 r_2 \sin \psi_c} \quad (2)$$

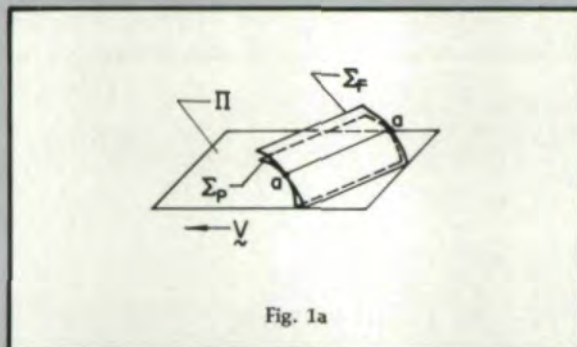

Fig. 1a

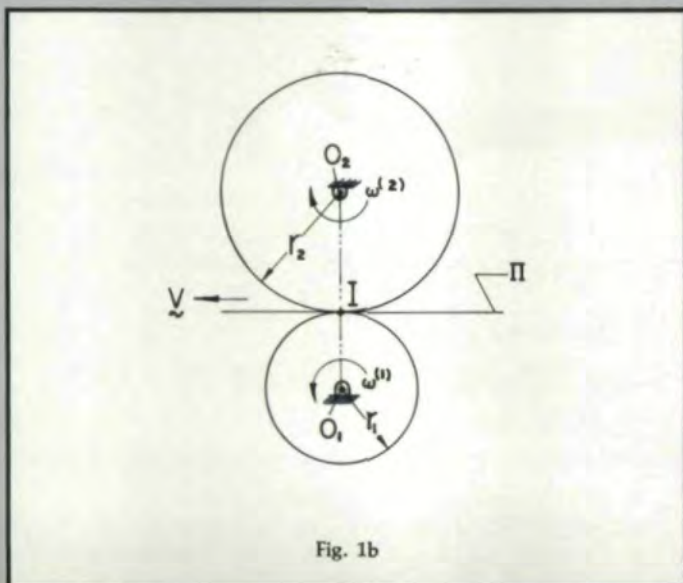

Fig. 1b

# *More than a gear inspector*



**THE HÖFLER 4-AXIS CNC  
COORDINATE MEASURING CENTER  
with a 3-Axis Measuring Probe**

Gears, cutting tools and parts shown are currently being checked by this measuring center using our industry-leading, job proven software packages. SPC options are readily available.

CIRCLE A-5 ON READER REPLY CARD

ion machine...

**HÖFLER**

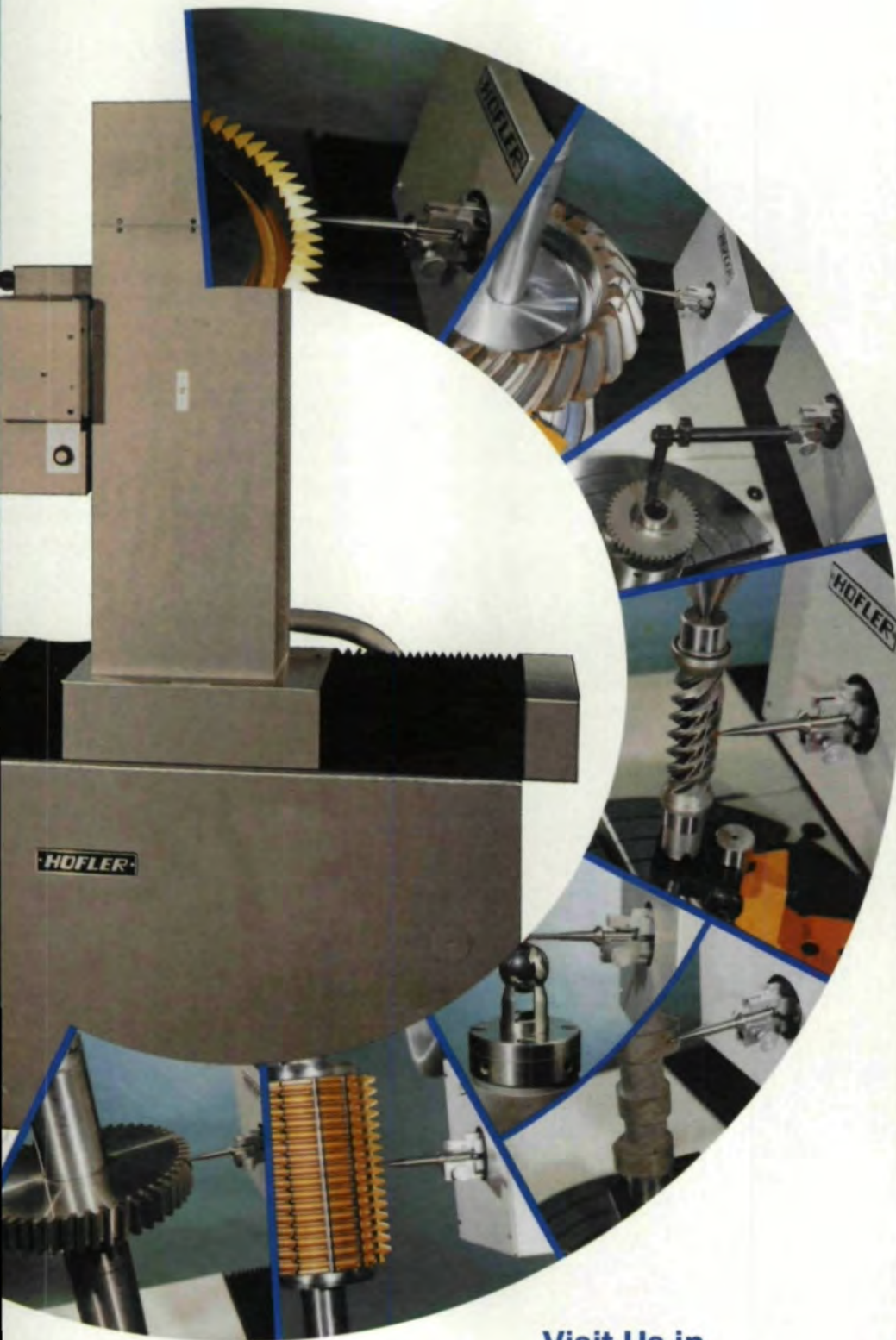

**STARCUT SUPPLIED  
PRODUCTS AND  
SERVICES**

**Star Machine Tools**

Standard and CNC Hob  
Sharpeners  
Shaper Cutter Sharpeners  
CNC Drill and Reamer  
Sharpeners (5-Axis)  
CNC Tool Grinder (6-Axis)

**Star Cutting Tools**

Hobs  
Form-Relieved Cutters  
Gun Drills  
Gun Reamers  
Keyseat Cutters

**Gold Star Coatings**

**Lorenz**

Shaper Cutters

**Hurth Machine Tools**

CNC Gear Shaving  
Machines  
CNC Gear Rolling Machines  
Gear Testing Machines  
Shaving Cutter Grinding  
Machines  
CNC Gear Tooth Chamfering  
Machines  
Gear Deburring Machines  
CNC Hard Gear Finishing  
Machines

**Höfler**

CNC Inspection Equipment  
for Gears and Gear  
Cutting Tools

**TIN Coating Systems**

Complete Turnkey  
Applications

**PLANRING USA, INC.**

Planning & Engineering  
Flexible Machining Systems

**Stieber**

Precision Clamping Tools

*Contact us for detailed infor-  
mation and specifications  
on this CNC Coordinate  
Measuring Center as well as  
the complete line of Höfler  
gear inspection equipment.*

**Visit Us in  
Booth 305  
Gear Expo '87**

 Since 1927  
**Star**  
**STARCUT SALES, INC.**  
23461 Industrial Park Drive  
Farmington Hills, MI 48024  
313/474-8200 Telex 230-411

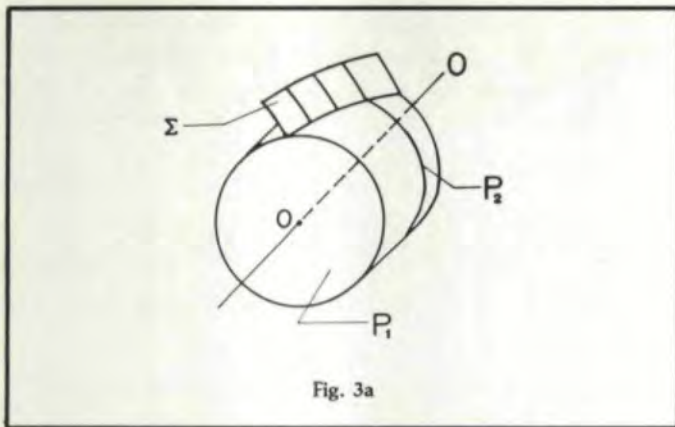

Fig. 3a

Here  $\rho_2 = C_2M$  and  $\rho_1 = C_1M$  where  $C_2$  and  $C_1$  are the centers of curvatures of shapes  $\Sigma_2$  and  $\Sigma_1$ , respectively;  $\Delta\rho = \rho_2 - \rho_1$ ;  $l = IM$ ;  $r_1 = O_1I$  and  $r_2 = O_2I$ ;  $\psi_c$  is the angle formed by the shapes normal and line  $m - m$ .

From Equation (2) we find that the difference of curvature radii,  $\Delta\rho = \rho_2 - \rho_1$ , depends on parameters  $r_1$ ,  $r_2$ ,  $\psi$ ,  $l$  and  $\rho_1$ . Thus,  $\Delta\rho$  is not a free design parameter, and it cannot be chosen as desired. Therefore, the contacting stresses cannot be reduced substantially by minimizing  $\Delta\rho$ . This obstacle can be overcome if the gears are designed as helical gears provided with tooth surfaces which are in *point contact* instead of *line contact*.

Consider that the difference of curvature radii,  $\Delta\rho$ , provides optimal conditions for contacting stresses, but does not satisfy Equation (2). However, the gear ratio will be constant for helical gears if their surfaces are in point contact. This statement may be proven with the following considerations.

Fig. 3a shows a gear tooth surface of a helical gear. Such a surface may be represented as a set of planar curves which lie in planes perpendicular to the gear axis. For instance,  $\Sigma^{(1)}$  and  $\Sigma^{(2)}$  are the shapes of the gear tooth surface which lie in planes  $P_1$  and  $P_2$ , respectively (Fig. 3a, b). The orientation of  $\Sigma^{(2)}$  is different from the orientation of  $\Sigma^{(1)}$ . To obtain a desired orientation for  $\Sigma^{(2)}$ , we have to rotate the gear through a definite angle by which point  $M'$  will come to the position  $L$ ; the line  $ML$  is parallel to the axis of gear rotation.

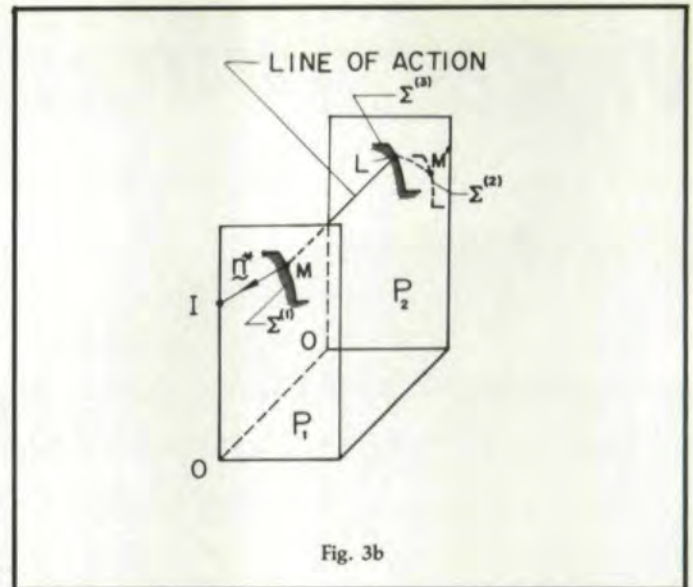

Fig. 3b

Assume that initially  $M$  is the point of tangency of the mating surfaces (Fig. 3b). The normal  $n^*$  to the shape  $\Sigma^{(1)}$  passes through the instantaneous center of rotation,  $I$ . The location of  $I$  on the center distance corresponds to the given gear ratio. After rotation through a definite angle, shape  $\Sigma^{(2)}$  which lies in plane  $P_2$ , will have the same orientation as that of  $\Sigma^{(1)}$  and the new point of contact of the mating surfaces will be  $L$  (Fig. 3b). The conditions of meshing at point  $L$  will be the same as that at point  $M$ .

We find from these considerations that helical gears which are in point contact will transform rotation with a constant gear ratio if their screw parameters  $h_1$  and  $h_2$  are related as follows:

$$\frac{h_1}{h_2} = \frac{\phi_1}{\phi_2} \quad (3)$$

Here

$$h_i = r_i \tan \lambda_i \quad (i = 1, 2) \quad (4)$$

where  $\lambda_i$  is the lead angle, and  $r_i$  is the radius of the gear axode—the pitch cylinder.

Thus, the transformation of rotation may be performed with a constant gear ratio which is independent of the curvatures of the gear tooth surfaces.

### Generating Surfaces

Fig. 4 shows the normal section of the *space* of rack cutter  $F$  which generates the tooth of gear 1. The shapes of the rack cutter for each of its sides represent two circular arcs centered at  $C_F$  and  $C_F^{(f)}$ , respectively. The circular arc of radius  $\rho_F^{(f)}$  generates the fillet surface of the gear. Point  $O_a^{(f)}$  lies in plane  $\Pi$  (Fig. 1).

Fig. 5 shows the normal section of the *tooth* of the rack cutter  $P$  which generates the space of gear 2. The shape of the rack cutter for each side represents two circular arcs centered at  $C_P$  and  $C_P^{(f)}$ , respectively. The circular arc with radius  $\rho_P^{(f)}$  generates the fillet surface of gear 2.

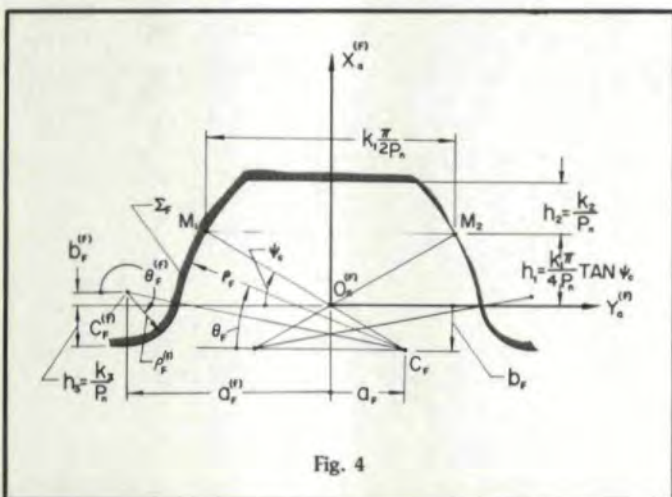

Fig. 4

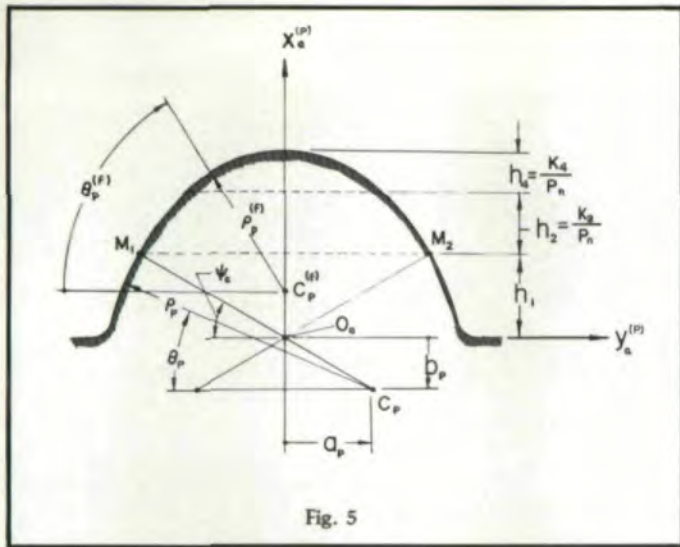

Fig. 5

The shapes of the mating rack cutters do not coincide; rather they are in tangency at points  $M_1$  and  $M_2$ .

We may represent all four circular arcs in the coordinate systems  $S_a$  ( $x_a, y_a, z_a$ ) by the same equations.

$$x_a^{(i)} = \rho_i \sin \theta_i - b_i, \quad y_a^{(i)} = -(\rho_i \cos \theta_i - a_i), \quad z_a^{(i)} = 0 \quad (5)$$

Here  $\rho_i$  is the radius of the circular arc;  $a_i$  and  $b_i$  are algebraic values which determine the location of the center of the circular arc;  $\theta_i$  is the variable parameter which determines the location of a point on the circular arc ( $\theta_i$  is measured clockwise from the negative axis  $y_a$ );  $P_n$  is the diametral pitch in the normal section; and  $\psi_c$  is the pressure angle. The element proportions of rack cutters  $h_1, h_2, h_3$  and  $h_4$  are expressed in terms of normal diametral pitch,  $P_n$ .

It was mentioned above that Equations (5) represent all four circular arcs—the shapes of both rack cutters. Thus equations

$$x_a^{(F)} = \rho_F \sin \theta_F - b_F, \quad y_a^{(F)} = -(\rho_F \cos \theta_F - a_F), \quad z_a^{(F)} = 0 \quad (6)$$

represent the circular arc centered at  $C_F$  (Fig. 4).

Knowing the normal section of the rack cutter, we may derive equations of the generating surface using the matrix form of coordinate transformation. Consider that a rack cutter shape is represented in the coordinate system  $S_a^{(i)}$  (Fig. 6a). The rack cutter surface will be generated in the coordinate system  $S_c^{(i)}$  (Fig. 6b) while the coordinate system  $S_a^{(i)}$  translates along the line  $O_c^{(i)} O_a^{(i)}$  with respect to  $S_c^{(i)}$ ;  $|O_c O_a| = u_i$  is a variable parameter. Using the matrix equation

$$\begin{bmatrix} x_c^{(i)} \\ y_c^{(i)} \\ z_c^{(i)} \\ 1 \end{bmatrix} = \begin{bmatrix} 1 & 0 & 0 & 0 \\ 0 & \sin \lambda_i & \cos \lambda_i & u_i \cos \lambda_i \\ 0 & -\cos \lambda_i & \sin \lambda_i & u_i \sin \lambda_i \\ 0 & 0 & 0 & 1 \end{bmatrix} \begin{bmatrix} x_a^{(i)} \\ y_a^{(i)} \\ z_a^{(i)} \\ 1 \end{bmatrix} \quad (7)$$

we obtain

$$\left. \begin{aligned} x_c^{(i)} &= \rho_i \sin \theta_i - b_i \\ y_c^{(i)} &= -(\rho_i \cos \theta_i - a_i) \sin \lambda_i + u_i \cos \lambda_i \\ z_c^{(i)} &= (\rho_i \cos \theta_i - a_i) \cos \lambda_i + u_i \sin \lambda_i \end{aligned} \right\} \quad (8)$$

In the derivation of Equations (8), we assume that  $a_i > 0$  and  $b_i > 0$ . The unit normal to the rack cutter surface is given by the equations

$$n_{ci}^{(i)} = \frac{N_c^{(i)}}{|N_c^{(i)}|}, \quad N_c^{(i)} = \frac{\partial r_c^{(i)}}{\partial \theta_i} \times \frac{\partial r_c^{(i)}}{\partial u_i} \quad (9)$$

Equations (8) and (9) yield

$$[n_c^{(i)}] = \begin{bmatrix} \sin \theta_i \\ -\cos \theta_i \sin \lambda_i \\ \cos \theta_i \cos \lambda_i \end{bmatrix} \quad (10)$$

Consider that coordinate systems  $S_c^{(F)}$  and  $S_c^{(P)}$  coincide. Surfaces  $\Sigma_c^{(F)}$  and  $\Sigma_c^{(P)}$  will be in tangency if the following equations are satisfied:

$$x_c^{(F)} = x_c^{(P)}, \quad y_c^{(F)} = y_c^{(P)}, \quad z_c^{(F)} = z_c^{(P)} \quad (11)$$

$$n_{xc}^{(F)} = n_{xc}^{(P)}, \quad n_{yc}^{(F)} = n_{yc}^{(P)}, \quad n_{zc}^{(F)} = n_{zc}^{(P)} \quad (12)$$

## NOW CUT KEYWAYS AUTOMATICALLY

**THE WORLD'S BEST-SELLING KEYSEATER IS NOW EVEN BETTER**

**Introducing the New Mitts & Merrill PC/Hydraulic Keyseater**

If you need more than 10 keyways cut each week, chances are very good your company's investment in a new Mitts & Merrill PC/Hydraulic Keyseater can easily be justified. Let us know your

Easy to operate micro-processor controls

requirements. We'll show you why using a new Mitts & Merrill PC/Hydraulic Keyseater is the most cost-effective way for you to cut accurate keyways.

- Faster set-up
- Rugged stability
- Depth repeatability to .001"

**Mitts & Merrill Products**  
**CARTHAGE MACHINE COMPANY**

571 WEST END AVENUE • CARTHAGE, NY 13619 • TELEX 937-378 • PHONE (315) 493-2380

CIRCLE A-17 ON READER REPLY CARD

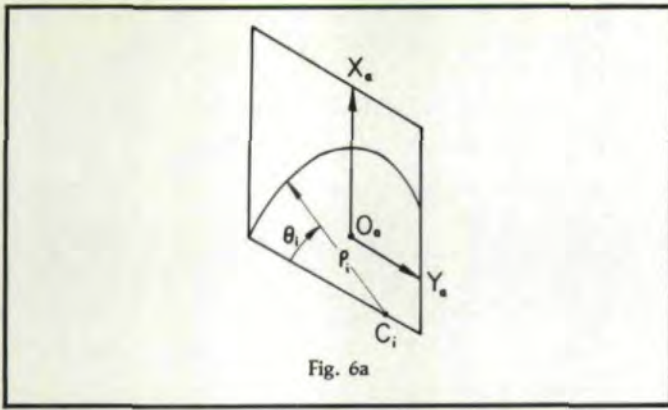

Fig. 6a

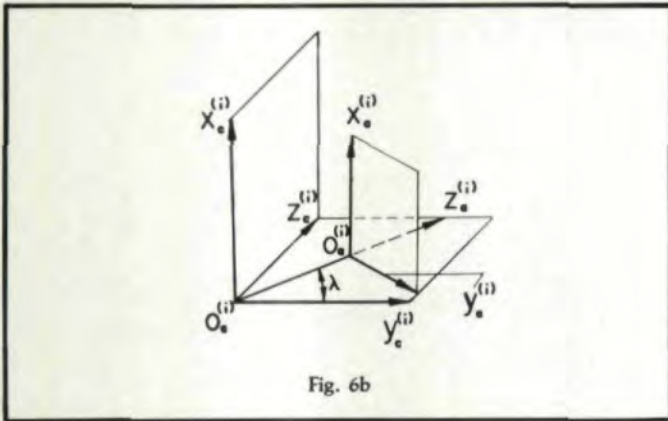

Fig. 6b

Equations (8), (10), (11), and (12) yield that surfaces  $\Sigma_F$  and  $\Sigma_P$  are in tangency along a straight line  $a - a$  (Fig. 1a) if the following conditions are satisfied:

$$\theta_F = \theta_P = \psi_c, \quad u_F = u_P, \quad \lambda_F = \lambda_P, (\rho_P - \rho_F) \sin \psi_c = b_P - b_F, \\ (\rho_P - \rho_F) \cos \psi_c = a_P - a_F \quad (13)$$

Here  $\psi_c$  is the pressure angle.

The normal sections of the gear teeth do not coincide with the corresponding normal sections of the rack cutters. Neglecting the difference, we may identify the normal sections of gear teeth with the normal sections of rack cutters. The shapes of the gear teeth in the normal section are shown in Fig. 7. These shapes are in tangency at point  $M_1$  and  $M_2$ . Considering the two sides of the teeth, we have to consider two pairs of surfaces,  $\Sigma_F$  and  $\Sigma_P$ . Each pair of these surfaces is in tangency along a straight line  $a - a$  (Fig. 1a) and point  $M_i$  ( $i = 1, 2$ ) lies on  $a - a$ . The shape normals at  $M_1$  and  $M_2$  pass through point  $I$ , which lies on the instantaneous axis of rotation and coincides with the origins  $O_a^{(F)}$  and  $O_a^{(P)}$  for the position shown.

### Gear Tooth Surfaces

Considering the generation of the gear 1 tooth surface, we use the coordinate systems  $S_c^{(F)}$ ,  $S_1$ , and  $S_h$ , which are rigidly connected to the rack cutter  $F$ , gear 1, and the frame, respectively (Fig. 8a). Similarly, considering the generation of gear 2 tooth surface, we use coordinate systems  $S_c^{(P)}$ ,  $S_2$ , and  $S_f$  which are rigidly connected to the rack cutter  $P$ , to gear 2 and to the frame, respectively. We use two different

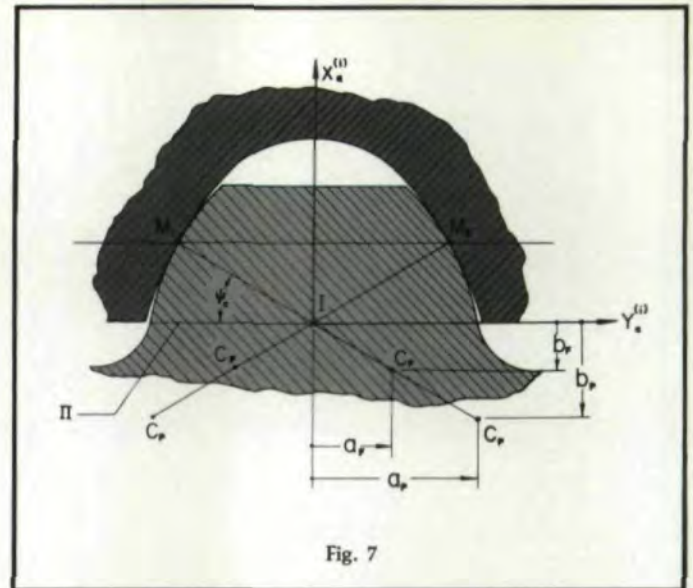

Fig. 7

fixed coordinates,  $S_f$  and  $S_h$ , to simulate various errors of assembly. Coordinate systems  $S_f$  and  $S_h$  coincide with each other if errors of gear assembly do not exist. We can simulate these errors by changing the location and orientation of the fixed coordinate system  $S_h$  with respect to  $S_f$ .

The determination of the gear tooth surface  $\Sigma_1$  ( $\Sigma_1$  represents gear 1 tooth surface.) is based on the following considerations. (See also the Appendix.)

Step 1: The line of contact of surfaces  $\Sigma_F$  and  $\Sigma_1$  may be represented in the coordinate system  $S_c^{(F)}$  as follows:<sup>(5)</sup>

$$\mathbf{r}_c^{(F)}(u_F, \theta_F) \in C^1, (u_F, \theta_F) \in A_F, \mathbf{N}_c^{(F)} \cdot \mathbf{v}_c^{(F)} \\ = f_F(u_F, \theta_F, \phi_1) = 0 \quad (14)$$

Here  $u_F, \theta_F$  are the surface coordinates of  $\Sigma_F$ ;  $\mathbf{N}_c^{(F)}$  is the surface normal;  $\mathbf{v}_c^{(F)}$  is the sliding velocity;  $\phi_1$  is the angle of rotation of gear 1; and  $A_F$  is the area of parameters  $u_F, \theta_F$ . Equation 15,

$$f_F(u_F, \theta_F, \phi_1) = 0 \quad (15)$$

is called the equation of meshing.

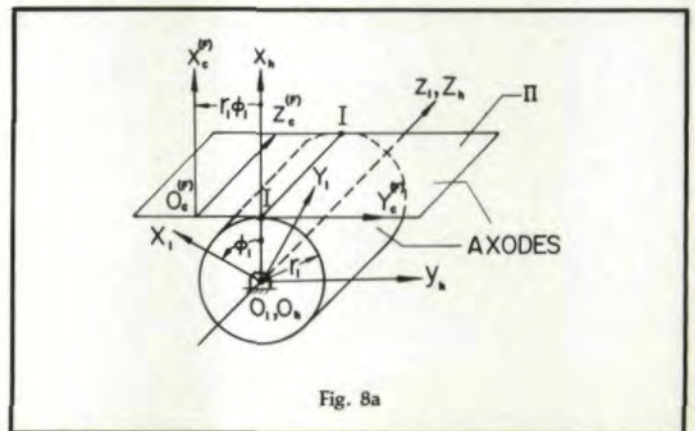
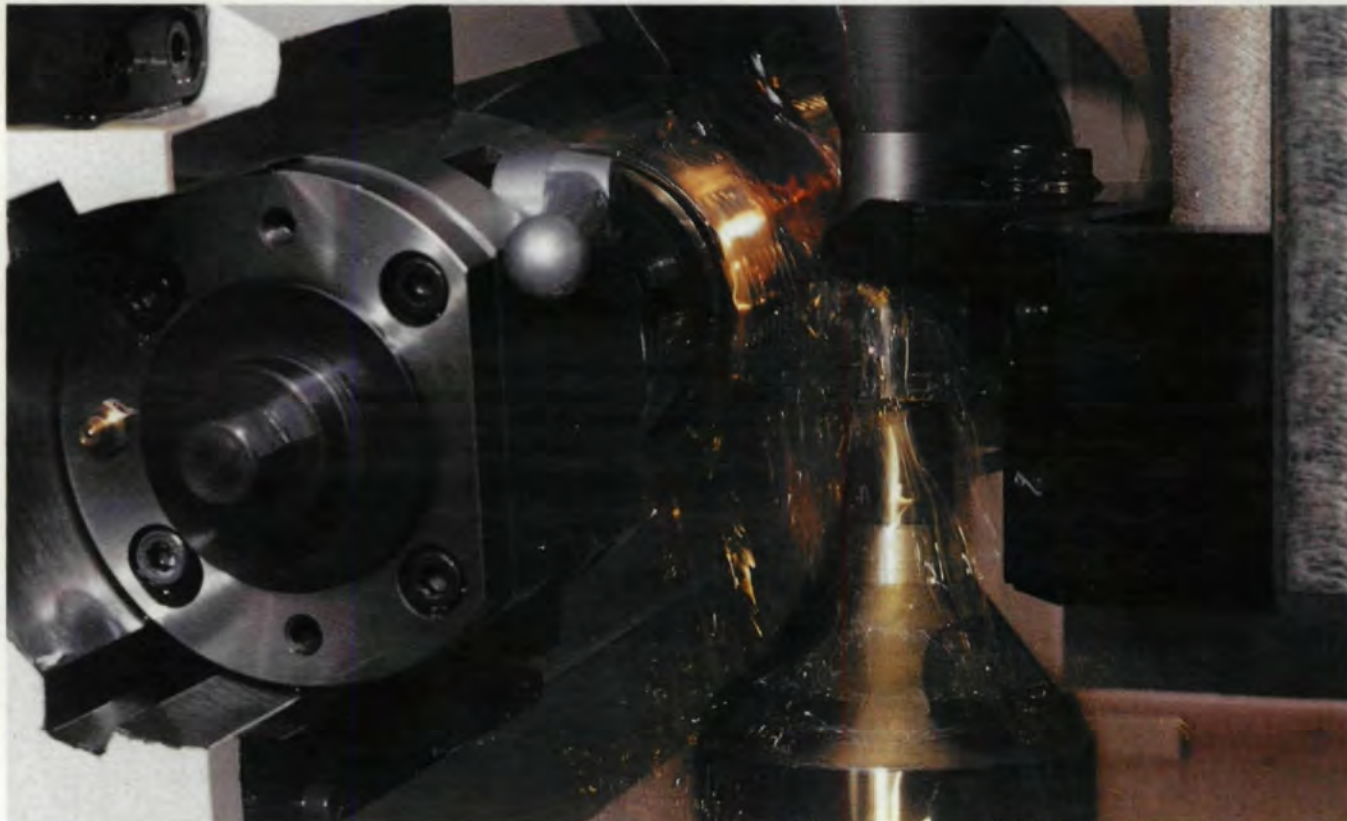

Fig. 8a

# NOW A NEW HOBBER FROM MITSUBISHI, YOU CAN'T BEAT IT! COMPARE AND SEE!



In addition to the GA-series CNC gear hobbing machines which covers a range from 10" to 40" diameter gears, Mitsubishi is now announcing the new high performance GA15CNC gear hobber. The GA15CNC is a 6" machine with hob rotation of 1000rpm and table rotation of 150rpm as standard where it is an option with other manufacturers. This enables you to use multiple thread hobs to get higher production rates. Our results show that the cutting time can be reduced to about one half of the conventional machines. Needless to say, with the CNC control feature, there are no gears to change. Quick change hobs and quick change fixtures all adds up to quick changeover time. Setup time is reduced to about one third compared to conventional machines. "MENU" programming is another great feature. This relieves the operator from tedious calcula-



tions. Just input the gear and hob data. The built-in software will do all the calculations for you! You can also save floor space, hence money, with our machine. It takes only 50 sq. ft. of floor space! Compare it with the others. You'll be saving 1/2 to 3/4 of your valuable floor space! This is only the beginning! For further details, call or write us NOW!

#### Main Specifications

Maximum part diameter	..... 6", optional 8"
Maximum pitch	..... 6DP
Maximum hob diameter	..... 4.7"
Maximum hob length	..... 7"
Hob shift	..... 5"
Hob speed	..... 150 to 1000 rpm
Hob head swivel	..... +/- 45 deg.
Table speed	..... 150 rpm
Main motor	..... 7.5 hp

## CNC GEAR HOBBER

GEAR EXPO '87  
Booth #323



**MITSUBISHI**  
HEAVY INDUSTRIES, LTD.

5-1, Marunouchi 2-chome, Chiyoda-ku, Tokyo, Japan  
Cable Address: HISHIJU TOKYO

**Mitsubishi Heavy Industries America, Inc.**  
873 Supreme Drive, Bensenville, IL 60106 Phone: (312) 860-4220

**Mitsubishi International Corporation**  
873 Supreme Drive, Bensenville, IL 60106 Phone: (312) 860-4222

CIRCLE A-8 ON READER REPLY CARD

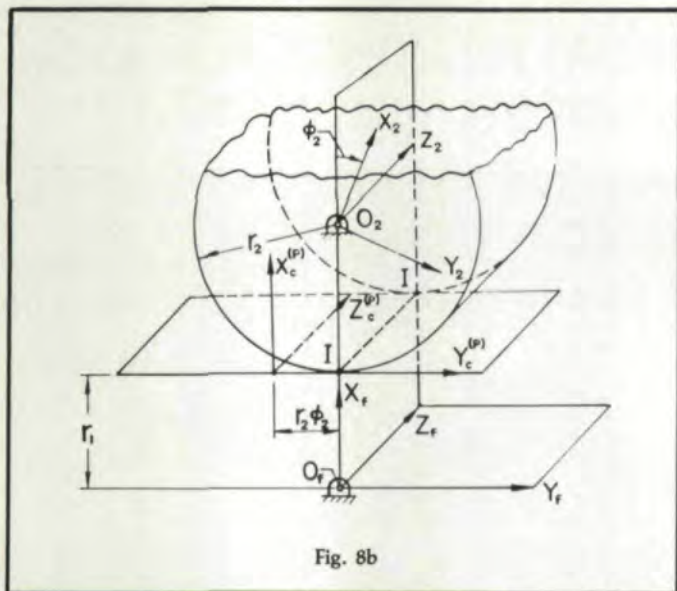

Fig. 8b

An alternative method for the determination of the equation of meshing is based on the following equations:

$$\frac{X_c^{(F)} - x_c^{(F)}}{N_{xc}^{(F)}} = \frac{Y_c^{(F)} - y_c^{(F)}}{N_{yc}^{(F)}} = \frac{Z_c^{(F)} - z_c^{(F)}}{N_{zc}^{(F)}} \quad (16)$$

Here  $X_c^{(F)}$ ,  $Y_c^{(F)}$ ,  $Z_c^{(F)}$  are coordinates of a point on the instantaneous axis of rotation  $I - I$ , which is represented in  $S_c^{(F)}$ .  $x_c^{(F)}$ ,  $y_c^{(F)}$  and  $z_c^{(F)}$  are the coordinates of a point on surface  $\Sigma_f$ , and  $N_{xc}^{(F)}$ ,  $N_{yc}^{(F)}$  and  $N_{zc}^{(F)}$  are the direction cosines of the surface normal  $\mathbf{N}_c^{(F)}$ .

*Step 2:* The generated gear 1 tooth surface is represented in coordinate system  $S_1$  by the following equations:

$$f_f(u_f, \theta_f, \phi_1) = 0, [r_1] = [M_{1f}] [M_{fc}^{(F)}] [r_c^{(F)}] \quad (17)$$

Here matrices  $[M_{fc}^{(F)}]$  and  $[M_{1f}]$  represent the coordinate transformation in transition from  $S_c^{(F)}$  via  $S_f$  to  $S_1$ . The surface unit normal may be determined by the following matrix equation:

$$[n_1] = [L_{1f}] [L_{fc}^{(F)}] [n_c^{(F)}] \quad (18)$$

We may determine matrices  $[L_{1f}]$  and  $[L_{fc}^{(F)}]$  by deleting the last column and row in matrices  $[M_{1f}]$  and  $[M_{fc}^{(F)}]$ .

*Step 3:* Since we will consider the mesh of gear tooth surfaces we have to represent these surfaces in a coordinate system rigidly connected to the frame. For this purpose we choose the coordinate system  $S_f$  and represent  $\Sigma_1$ , gear 1 tooth surface, using the following equations:

$$[r_f^{(1)}] = [M_{f1}] [r_1]$$

$$[n_f^{(1)}] = [L_{f1}] [n_1]$$

Elements of matrices  $[M_{f1}]$  and  $[L_{f1}]$  are expressed in terms of  $\phi'_1$ —the angle of rotation of gear 1, which is in mesh with gear 2. Henceforth, we will differentiate between two designa-

tions of the angle of rotation of the gears:  $\phi_i$  is the angle of rotation of gear  $i$  in mesh with the corresponding rack cutter, and  $\phi'_i$  is the angle of rotation of the one gear in mesh with the mating gear.

The equations of gear 2 tooth surface,  $\Sigma_2$ , may be determined in a similar manner. Initially, we may represent these equations in the coordinate system  $S_2$ , rigidly connected to gear 2 (Fig. 8b) and then in coordinate system  $S_f$  rigidly connected to the frame.

### Simulations of Conditions of Meshing

We may simulate the conditions of meshing by changing the settings and orientation of the coordinate system  $S_h$  with respect to  $S_f$ . For instance, simulating the change of center distance  $\Delta C$ , we may displace the origin  $O_h$  of the coordinate system  $S_h$  by  $\Delta C$  with respect to  $O_f$  (Fig. 9a). Then, using the coordinate transformation from  $S_h$  to  $S_f$  we may represent the equations of surface  $\Sigma_1$  and its surface normal in system  $S_f$ .

The conditions of continuous tangency of gear tooth surfaces  $\Sigma_1$  and  $\Sigma_2$  are represented by the following equations: <sup>(5, 6)</sup>

$$r_f^{(1)}(\theta_f, \phi_1, \mu_1) = r_f^{(2)}(\theta_p, \phi_2, \mu_2) \quad (19)$$

$$n_f^{(1)}(\theta_f, \mu_1) = n_f^{(2)}(\theta_p, \mu_2) \quad (20)$$

Equation (19) expresses that surfaces  $\Sigma_1$  and  $\Sigma_2$  have a common point determined with the position vectors  $r_f^{(1)}$  and  $r_f^{(2)}$ . Equation (20) indicates that surfaces  $\Sigma_1$  and  $\Sigma_2$  have a common unit normal at their point. Equations (19) and (20), when considered simultaneously, yield a system of five independent equations only, since  $|n_f^{(1)}| = |n_f^{(2)}| = 1$ . These five equations relate six unknowns:  $\theta_f$ ,  $\phi_1$ ,  $\phi'_1$ ,  $\theta_p$ ,  $\phi_2$ ,  $\phi'_2$ , and thus, one of these unknowns may be considered as a variable.

**Change of Axes' Distance.** Equations (19), (20), (A.9-A.14) yield the following procedure for computations:

*Step 1:* Using equations  $n_{zf}^{(1)} = n_{zf}^{(2)}$ , we obtain

$$\cos\theta_f \cos\lambda_f = \cos\theta_p \cos\lambda_p \quad (21)$$

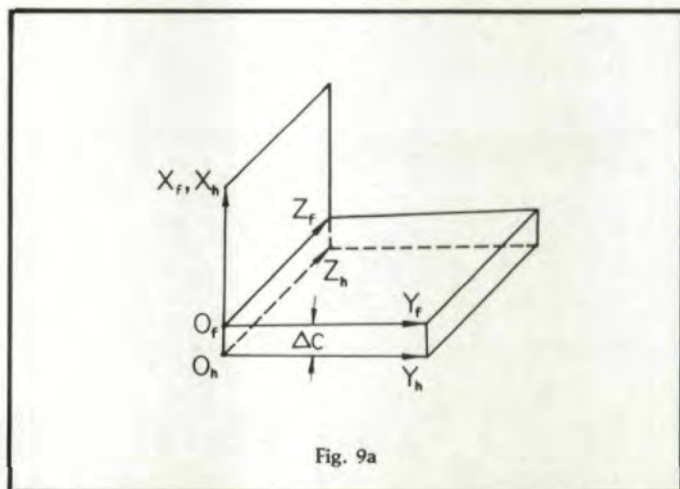

Fig. 9a



Equation (21) with  $\lambda_F = \lambda_P = \lambda$  yields that

$$\theta_F = \theta_P = \theta \quad (22)$$

Step 2: Using equations  $n_{y_f}^{(1)} = n_{y_f}^{(2)}$ ,  $y_f^{(1)} = y_f^{(2)}$  and  $x_f^{(1)} = x_f^{(2)}$ , we obtain the following system of three equations in three unknowns ( $\theta$ ,  $\mu_1$ , and  $\mu_2$ ):

$$\sin\theta\sin\mu_1 - \cos\theta\sin\lambda\cos\mu_1 = -\sin\theta\sin\mu_2 - \cos\theta\sin\lambda\cos\mu_2 \quad (23)$$

$$\begin{aligned} (\rho_F\sin\theta - b_F)(\sin\theta\sin\mu_1 - \cos\theta\sin\lambda\cos\mu_1) + r_1\sin\theta\sin\mu_1 = \\ -(\rho_P\sin\theta - b_P)(\sin\theta\sin\mu_2 + \cos\theta\sin\lambda\cos\mu_2) + r_2\sin\theta\sin\mu_2 \end{aligned} \quad (24)$$

$$\begin{aligned} (\rho_F\sin\theta - b_F)(\sin\theta\cos\mu_1 + \cos\theta\sin\lambda\sin\mu_1) + r_1\sin\theta\cos\mu_1 = \\ (\rho_P\sin\theta - b_P)(\sin\theta\cos\mu_2 - \cos\theta\sin\lambda\sin\mu_2) - r_2\sin\theta\cos\mu_2 + \\ C\sin\theta \end{aligned} \quad (25)$$

Here  $C = r_1 + r_2 + \Delta C$  and  $\Delta C$  is the change of center distance.

The solution to these equations for  $\theta$ ,  $\mu_1$  and  $\mu_2$  provides constant values whose magnitude depends on the operating center distance  $C$  only. (The change of the center distance is  $\Delta C$ ). The location of the center of the contacting ellipse

is determined by  $\theta(\Delta C)$ . Thus, the bearing contact also depends on  $\Delta C$ .

We may check the solution to Equations (23), (24) and (25) using the equation  $n_{x_f}^{(1)} = n_{x_f}^{(2)}$  which yields

$$\sin\theta\cos\mu_1 + \cos\theta\sin\lambda\sin\mu_1 = \sin\theta\cos\mu_2 - \cos\theta\sin\lambda\sin\mu_2 \quad (26)$$

Step 3: Knowing  $\theta$ , we may determine the relation between parameters  $\phi_1$  and  $\phi_2$  using equation  $z_f^{(1)} = z_f^{(2)}$ , which yields

$$\begin{aligned} \rho_F\cos\theta\cos\lambda - \frac{a_F}{\cos\lambda} + b_F\cot\theta\tan\lambda\sin\lambda + r_1\phi_1\tan\lambda = \\ \rho_P\cos\theta\cos\lambda - \frac{a_P}{\cos\lambda} + b_P\cot\theta\tan\lambda\sin\lambda + r_2\phi_2\tan\lambda \end{aligned} \quad (27)$$

Equation (27) provides a linear function which relates  $\phi_1$  and  $\phi_2$ , since  $\theta$  is constant.

Step 4: It is easy to prove that since  $\theta$ ,  $\mu_1$  and  $\mu_2$  have constant values, the angular velocity ratio for the gears does not depend on the center distance.

The proof is based on the following considerations: 1) Equation (27) with  $\theta = \text{constant}$ , yields that  $r_1d\phi_1 = r_2d\phi_2$  and  $d\phi_1/d\phi_2 = r_2/r_1$ . 2) Since  $\mu_1 = \phi_1 - \phi'_1$  and  $\mu_2 = \phi_2 - \phi'_2$  are constant, we obtain that  $d\phi'_1 = d\phi_1$ ,  $d\phi'_2 = d\phi_2$  and

$$m_{12} = \frac{\omega^{(1)}}{\omega^{(2)}} = \frac{d\phi'_1}{d\phi'_2} = \frac{r_2}{r_1} \quad (28)$$

## EQUAL TO THE TASK



If you're a designer or OEM searching for large spiral bevel gear sets that are equal to the task at hand, Amarillo Gear Company can help.

When it's required, Amarillo Gear can case-harden its spiral bevel gears and then hard-cut them to AGMA quality level 10 tolerances with a 16 RMS surface finish. When job conditions are less demanding, Amarillo Gear can design and produce a more economical gear that measures up to your exact need.

Quiet and dependable, their quality reflects Amarillo Gear's 35 years experience manufacturing spiral bevel gears.

Call Amarillo Gear Company. You'll find our work more than equal to your production requirements and custom applications.

**Spiral Bevel Gears Up to 100" Diameter**



AMARILLO GEAR COMPANY  
A MEMBER OF THE MARMON GROUP OF COMPANIES  
P. O. BOX 1789, AMARILLO, TEXAS 79105  
806/622-1273  
TWX 910-898-4128 Amadrive

# IAD IS GEARED TO MEET YOUR MOST PRECISE MEASURING REQUIREMENTS WITH THE FETTE (PKM) INSPECTION CENTER.



"Hob Measuring is our Speciality!"

## IAD's Fette Inspection Center Provides .000003937 in. Positioning Accuracy.

IAD's Fette Inspection Center provides unparalleled accuracy to meet the industries' most precise measuring requirements. This IAD system is available with an exclusive software library and an Allen-Bradley CNC control that provides exact dimensional measurements of: Turbine Blades, Gear Clutch Plates, Hobs, Worm Gears, Control Cams, Double Gears, Spur Gears and more.

The highest degree of reproducibility is attained with .0001 MM accuracy. A Hewlett Packard computer with expanded graphics capability displays any deviation of involute, lead spacing, run-out, flank and more. The systems modular design allows variable applications from production line to laboratory inspection.

A patented measuring probe allows continuous probing of components. The system is capable of robotic loading and unloading allowing easy interface to automated machining cells. IAD's Fette Inspection Center is guaranteed to meet your highest measuring standards.

IAD's highly trained service engineers provide prompt service any time of the year. IAD also extends the fastest return on your investment with special terms and financing.

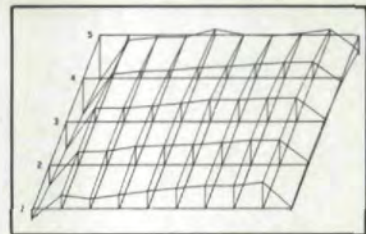

Bevel Gear Check

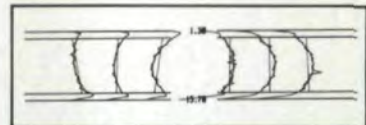

Involute Gear Check



FOR MORE INFORMATION  
OR APPLICATIONS ASSISTANCE,  
CALL OR WRITE:



**IAD INCORPORATED**

1307 Rankin • Troy, Mich. 48083-2828

Telephone (313) 588-2000

Telex (810) 221-5027 • Fax (313) 588-5889

CIRCLE A-16 ON READER REPLY CARD

Step 5: It is evident that since  $\theta$ ,  $\mu_1$  and  $\mu_2$  have constant values, the line of action of the gear tooth surfaces represents, in the fixed coordinate system  $S_f$ , a straight line which is parallel to the  $z_f$ -axis. We may determine the coordinates  $x_f^{(i)}$  and  $y_f^{(i)}$  ( $i = 1, 2$ ) of the line of action using Equations (A.9) or (A.12). (See the Appendix.) The location of the instantaneous point of contact on the line of action may be represented as a function of  $\phi_1'$ :

$$z_f^{(1)} = \rho_F \cos \theta \cos \lambda - \frac{a_F}{\cos \lambda} + b_F \cot \theta \tan \lambda \sin \lambda + r_1 (\mu_1 + \phi_1') \tan \lambda \quad (29)$$

Step 6: We may also derive an approximate equation which relates  $\theta$  and the change of the center distance,  $\Delta C$ . Since  $\mu_1$  and  $\mu_2$  are small, we may make  $\cos \mu_i = 1$  and  $\sin \mu_i = 0$  in Equation (25). We then obtain

$$\rho_F \sin \theta - b_F + r_1 = \rho_P \sin \theta - b_P - r_2 + C \quad (30)$$

where  $C = r_1 + r_2 + \Delta C$ .

Equation (30) yields

$$\sin \theta = \frac{\Delta C + b_F - b_P}{\rho_F - \rho_P} \quad (31)$$

The nominal value of  $\theta^0$  which corresponds to the theoretical value of the center distance  $C$ , where  $C = r_1 + r_2$ , is given by:

$$\sin \theta^0 = \frac{b_F - b_P}{\rho_F - \rho_P} \quad (32)$$

**Compensation for the Location of Bearing Contact Induced by  $\Delta C$ .** The sensitivity of the gears to the change of center distance,  $\Delta C$ , may be reduced by increasing the difference  $|\rho_F - \rho_P|$ . However, this results in the increase of contacting stresses.

The dislocation of the bearing contact may be compensated for by refinishing one of the gears (preferably the pinion) with new tool settings.

Consider that  $\theta^0$  is the nominal value for the pressure angle;  $b_F^0$  and  $b_P^0$ ,  $\rho_F^0$  and  $\rho_P^0$  are the nominal values for the machine settings and  $V_{\rho_F^0}$  are the nominal values for the radii of the circular arcs. These parameters are related by Equation (32). The location of the bearing contact won't be changed if the pinion is refinished with a new tool setting  $b_F$  determined as follows. (See Equation 31.)

$$\sin \theta^0 = \frac{\Delta C + b_F - b_P^0}{\rho_F^0 - \rho_P^0} \quad (33)$$

$$b_F = b_P^0 - \Delta C \quad (34)$$

**Change of Machine Tool Settings  $b_F$  and  $b_P$ .** The change of machine tool settings  $b_F$  and  $b_P$  causes: 1) the change of gear tooth thickness and backlash between the mating teeth, and 2) the dislocation of the bearing contact. The most dangerous result is the dislocation of the bearing contact.

Using similar principles of investigation, we may represent the new value of the pressure angle which corresponds to the changed machine tool settings by using the following equation:

$$\sin \theta = \frac{b_F - b_P}{\rho_F^0 - \rho_P^0} \quad (35)$$

Here  $b_F$  and  $b_P$  are the changed settings;  $b_F \neq b_F^0$ ,  $b_P \neq b_P^0$ , where  $b_F^0$  and  $b_P^0$  are the nominal machine settings;  $\theta \neq \theta^0$  is the new pressure angle.

We may compensate for the dislocation of the bearing contact making  $\theta = \theta^0$ . This can be achieved by refinishing of the pinion with a corrected setting  $\Delta b_F$ . Similar to Equation (33), we obtain

$$\sin \theta^0 = \frac{b_F - b_P^0 + \Delta b_F}{\rho_F^0 - \rho_P^0} \quad (36)$$

**Misalignment of Axes of Gear Rotation.** Consider that the axis of gear 1 rotation is not parallel to the axis of gear 2 rotation and forms an angle  $\Delta \gamma$  (Fig. 9b). The coordinate transformation from  $S_h$  to  $S_f$  is represented by the matrix equations

$$[r_f^{(1)}] = [M_{fh}] [r_h^{(1)}], [n_f^{(1)}] = [L_{fh}] [n_h^{(1)}] \quad (37)$$

Using Equations (37), (A.9-A.14) (19) and (20), we may represent the tangency of surfaces  $\Sigma_1$  and  $\Sigma_2$  for misaligned gears as follows:

$$A_2 \cos \mu_2 - B_2 \sin \mu_2 + C = A_1 \cos \mu_1 + B_1 \sin \mu_1 \quad (38)$$

$$\begin{aligned} -A_2 \sin \mu_2 - B_2 \cos \mu_2 &= (A_1 \sin \mu_1 - B_1 \cos \mu_1) \cos \Delta \gamma + \\ &(\rho_F \cos \theta_F \cos \lambda_F - \frac{a_F}{\cos \lambda_F} + b_F \cot \theta_F \tan \lambda_F \sin \lambda_F \\ &+ r_1 \phi_1 \tan \lambda_F) \sin \Delta \gamma \end{aligned} \quad (39)$$

(See Equations (A.11) and (A.14) in the Appendix.)

$$\begin{aligned} \rho_F \cos \theta_F \cos \lambda_P - \frac{a_P}{\cos \lambda_P} + b_P \cot \theta_P \sin \lambda_P \tan \lambda_P + r_2 \phi_2 \tan \lambda_P = \\ -(A_1 \sin \mu_1 - B_1 \cos \mu_1) \sin \Delta \gamma + (\rho_F \cos \theta_F \cos \lambda_F - \frac{a_F}{\cos \lambda_F} + \\ b_P \cot \theta_P \tan \lambda_P \sin \lambda_P + r_1 \phi_1 \tan \lambda_P) \cos \Delta \gamma \end{aligned} \quad (40)$$

$$\sin \theta_P \cos \mu_2 - \cos \theta_P \sin \lambda_P \sin \mu_2 = \sin \theta_F \cos \mu_1 + \cos \theta_F \sin \lambda_F \sin \mu_1 \quad (41)$$

$$\begin{aligned} -\sin \theta_P \sin \mu_2 - \cos \theta_P \sin \lambda_P \cos \mu_2 - \\ -\cos \theta_F \sin \lambda_F \cos \mu_1) \cos \Delta \gamma + \cos \theta_F \cos \lambda_F \sin \Delta \gamma \end{aligned} \quad (42)$$

$$\begin{aligned} \cos \theta_P \cos \lambda_P = -(\sin \theta_F \sin \mu_1 - \cos \theta_F \sin \lambda_F \cos \mu_1) \sin \Delta \gamma + \\ \cos \theta_F \cos \lambda_F \cos \Delta \gamma \end{aligned} \quad (43)$$

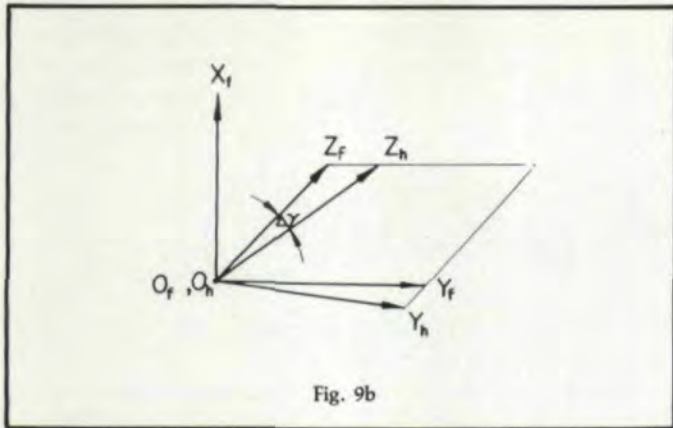

Fig. 9b

Equations (38-43) form a system of five independent equations in six unknowns:  $\theta_p$ ,  $\theta_F$ ,  $\mu_1$ ,  $\mu_2$ ,  $\phi_1$  and  $\phi_2$ . We may remind readers that only two equations from equation system (41-43) are independent since  $|\mathbf{n}_f^{(1)}| = 1$  and  $|\mathbf{n}_f^{(2)}| = 1$ .

The computational procedure is as follows: 1) We consider equations (38), (39), (42) and (43) which form a system of four equations in five unknowns:  $\theta_F$ ,  $\theta_p$ ,  $\mu_1$ ,  $\mu_2$  and  $\phi_1$ . Fixing in  $\phi_1$  we may obtain the solutions by  $\theta_F(\phi_1)$ ,  $\theta_p(\phi_1)$ ,  $\mu_1(\phi_1)$  and  $\mu_2(\phi_1)$ . 2) Using Equation (40) we obtain  $\phi_2(\phi_1)$ . 3) Then, using the equations

$$\phi'_1 = \phi_1 - \mu_1, \quad \phi'_2 = \phi_2 - \mu_2 \quad (44)$$

we can obtain the relation between the angles  $\phi'_2$  and  $\phi'_1$  of gear rotation. Function  $\phi'_2(\phi'_1)$  is a nonlinear function and its deviation from the linear function is given by

$$\Delta\phi'_2(\phi'_1) = \phi'_2(\phi'_1) - \frac{N_1}{N_2} \phi'_1 \quad (45)$$

Here  $\Delta\phi'_2(\phi'_1)$  represents the kinematical errors of the gear train and  $\phi_F(\phi'_1)$  and  $\theta_p(\phi'_1)$  represent the change of location of the bearing contact induced by the misalignment of gear axes.

**Compensation for the Location of Bearing Contact Induced by the Gear Misalignment.** The dislocation of the bearing contact induced by misalignment of the axes of gear rotation may be compensated for by the change of the lead angle  $\lambda_F$  (or  $\lambda_p$ ). This can be done technologically by refinishing of the pinion.

*Example 1: The Influence of Change of Axes Distance.* Given the rack parameters shown in Figs. 4 and 5: tooth numbers,  $N_1 = 12$ ,  $N_2 = 94$ ; the lead angle  $\lambda_F = \lambda_p = 75^\circ$ ; the nominal pressure angle  $\theta^0 = 30^\circ$ ; the normal diametral pitch  $P_n = 2$ ; the nominal axes distance  $C = 29.239515''$  and the change of axes distance,  $\Delta C = 0.021''$ . Due to the change of axes distance, the new value of the pressure angle  $\theta$  is: 1)  $\theta = 12.81412$  deg (exact solution provided by equation system (23-25); 2)  $\theta = 12.70903$  deg (approximate solution provided by Equation 31).

The compensation for the dislocation of bearing contact is achieved by the new machine setting  $b_F = -0.021$  in. which provides  $\theta = \theta^0 = 30$  deg although  $C = C_0 + \Delta C$ .

*Example 2: The Influence of Misalignment of Gear Axes.* The nominal rack and gear parameters are the same as shown

Table 1 Kinematical errors

No.	$\phi_1$	$\theta_F$	$\theta_p$	$\Delta\phi'_2$ (in s)
1	-20 deg	32.2520 deg	31.6521 deg	59.88 in.
2	-10 deg	32.2527 deg	31.6528 deg	29.94 in.
3	0 deg	32.2531 deg	31.6531 deg	0.00 in.
4	10 deg	32.2530 deg	31.6530 deg	-29.94 in.
5	20 deg	32.2526 deg	31.6526 deg	-59.89 in.

in Example 1. The misalignment is given by  $\Delta\gamma = 0.1$  deg (Fig. 9). The kinematical errors  $\Delta\phi'_2$  and the change of  $\theta_F$  and  $\theta_p$  are given in Table 1.

The compensation of kinematical errors is achieved with the change of the lead angle of the pinion  $\lambda_F = 75.093$  deg ( $\Delta\lambda_F = 0.093$  deg). The kinematical errors after compensation are given in Table 2.

Using the proposed method of compensation we could reduce substantially the kinematical errors induced by the misalignment of axes of gear rotation by approximately 250 times.

### Conclusion

The authors have considered the geometric properties of circular arc helical gears and the method of their generation.

## DEBURRS GEARS FAST



★ SET-UPS  
TAKE  
SECONDS

★ INTERNAL-EXTERNAL  
SPUR & HELICAL GEARS  
TO 20 INCHES DIAMETER

11707 McBean Drive, El Monte, CA 91732  
(818) 442-2898  
CIRCLE A-11 ON READER REPLY CARD

Table 2 Compensated kinematical errors

No.	$\phi_1$	$\theta_F$	$\theta_P$	$\Delta\phi'_2$ (in s)
1	-20 deg	30.1892 deg	30.1440 deg	0.23 in.
2	-10 deg	30.1900 deg	30.1449 deg	0.12 in.
3	0 deg	30.1905 deg	30.1452 deg	0.00 in.
4	10 deg	30.1904 deg	30.1452 deg	-0.12 in.
5	20 deg	30.1900 deg	30.1447 deg	-0.24 in.

A method for the simulation of the conditions of meshing and the bearing contact has been proposed. Using this method the sensitivity of the gears to the change of center distance and to the misalignment of gears has been investigated. A technological method for the improvement of the bearing contact for misaligned gears has been proposed. The presented numerical examples illustrate the influence of the abovementioned errors and the method for compensation of the dislocation of the bearing contact.

#### References

1. CHIRONIS, N. P. "Design of Novikov Gears." *Gear Design and Application*, N. P. Chironis (Ed.), McGraw-Hill, New York.
2. DAVIDOV, J. S. "The Generation of Conjugate Surfaces by Two Rigidly Connected Tool Surfaces," *Vestnik Mashinostroyeniya*, 1963, No. 2.
3. KUDRJAVZEV, V. N. *Epicycloidal Trains*, Mashgis, 1966.
4. LITVIN, F. L., "The Investigation of the Geometric Properties of a Variety of Novikov Gearing," *The Proceedings of Leningrad Mechanical Institute*, 1962, No. 24 (in Russian).
5. LITVIN, F. L., *Theory of Gearing*, 2nd edition, Nauka, 1968 (in Russian). New edition (in English), revised and completed, sponsored by NASA, is in press.
6. LITVIN, F. L., RAHMAN, P., and GOLDRICH, R. N., "Mathematical Models for the Synthesis and Optimization of Spiral Bevel Gear Tooth Surfaces," NASA Contractor Report 3553, 1982.
7. NIEMANN, G., "Novikov Gear System and Other Special Gear Systems for High Load Carrying Capacity," *VDI Berichte*, No. 47, 1961.
8. NOVIKOV, M. L., USSR Patent No. 109, 750, 1956.
9. WELLS, C. F., and SHOTTER, B. A., "The Development of 'Circarc' Gearing," *AEI Engineering*, March-April, 1962.
10. WILDHABER, E., US Patent, No. 1,601,750 issued Oct. 5, 1926, and "Gears with Circular Tooth Profile Similar to the Novikov System," *VDI Berichte*, No. 47, 1961.
11. WINTER, H., and LOOMAN, J., "Tools for Making Helical Circular Arc Spur Gears," *VDI Berichte*, No. 47, 1961.

## APPENDIX

### Gear Tooth Surfaces

*Gear 1 Tooth Surface.* Substituting subscript  $i$  for  $F$  in Equations (8) and (10) and taking into account that  $b_F > 0$ , we obtain:

$$[r_c^{(F)}] = \begin{bmatrix} \rho_F \sin \theta_F - b_F \\ (\rho_F \cos \theta_F - a_F) \cos \lambda_F + u_F \sin \lambda_F \\ 1 \end{bmatrix} \quad (\text{A.1})$$

$$[n_c^{(F)}] = \begin{bmatrix} \sin \theta_F \\ -\cos \theta_F \sin \lambda_F \\ \cos \theta_F \cos \lambda_F \end{bmatrix} \quad (\text{A.2})$$

Equations (A.1) and (A.2) represent the generating surface  $\Sigma_F$  and the unit normal to this surface. We may derive the equation of meshing using equations (A.1), (A.2) and (16) with

$$X_c^{(F)} = 0, \quad Y_c^{(F)} = r_1 \phi_1, \quad Z_c^{(F)} = l \quad (\text{A.3})$$

where  $X_c^{(F)}$ ,  $Y_c^{(F)}$  and  $Z_c^{(F)}$  are coordinates of the point of intersection of the normal to  $\Sigma_F$  and the instantaneous axis of rotation, I-I (Fig. 8a). We then obtain

$$f_F(u_F, \theta_F, \phi_1) = (r_1 \theta_1 - u_F \cos \lambda_F - a_F \sin \lambda_F) \sin \theta_F + b_F \cos \theta_F \sin \lambda_F = 0 \quad (\text{A.4})$$

Equation of meshing (A.4) yields

$$u_F = \frac{r_1 \phi_1 - a_F \sin \lambda_F}{\cos \lambda_F} + b_F \cot \theta_F \tan \lambda_F \quad (\text{A.5})$$

Equations (A.1) and (A.5), when considered simultaneously, represent a family of contacting lines on surface  $\Sigma_F$ . Eliminating  $u_F$ , we may represent this family of lines of contact as follows:

$$\begin{bmatrix} x_c^{(F)} \\ y_c^{(F)} \\ z_c^{(F)} \\ 1 \end{bmatrix} = \begin{bmatrix} \rho_F \sin \theta_F - b_F \\ -(\rho_F \sin \theta_F - b_F) \cot \theta_F \sin \lambda_F + r_1 \phi_1 \\ (\rho_F \sin \theta_F + b_F \tan^2 \lambda_F) \cot \theta_F \cos \lambda_F - \frac{a_F}{\cos \lambda_F} + r_1 \phi_1 \tan \lambda_F \\ 1 \end{bmatrix} \quad (\text{A.6})$$

**Q.** Would you believe that this steering gear pinion could be cold formed?



**A.** Believe it. Helicremental ESCOFIER machines can do it —and up to five times faster than any other method!

Cold forming precise helical configurations such as shaft steering gear pinions can *only* be done using ESCOFIER Helicremental machinery. Other benefits: chipless machining • improved mechanical properties • no waste • exceptional surface quality • exact tolerances • less downtime • lower unit cost • exceptional increased productivity. Call or write for information on how ESCOFIER rotary cold forming techniques can save time and money in your operation.



Leadership in rotary cold forming technology

10 Ann St., P.O. Box 379, Oakmont, PA 15139 • (412) 826-8588  
Telex: 264107 ESCO UR • Telefax: 412.826 8560

CIRCLE A-13 ON READER REPLY CARD

Using Equations (A.6) and the coordinate transformation from  $S_c^{(F)}$  to  $S_1$  we obtain

$$\begin{aligned} x_1 &= (q_f \sin \theta_f - b_f + r_1) \cos \phi_1 + (r_f \cos \theta_f \\ &\quad - b_f \cot \theta_f) \sin \phi_1 \sin \lambda_f \\ y_1 &= (q_f \sin \theta_f - b_f + r_1) \sin \phi_1 - (q_f \cos \theta_f \\ &\quad - b_f \cot \theta_f) \cos \phi_1 \sin \lambda_f \\ z_1 &= q_f \cos \theta_f \cos \lambda_f - \frac{a_f}{\cos \lambda_f} + b_f \cot \theta_f \tan \lambda_f \sin \lambda_f \\ &\quad + r_1 \phi_1 \tan \lambda_f \end{aligned} \quad (\text{A.7})$$

The surface unit normal is given by

$$[n_1] = \begin{bmatrix} \sin \theta_f \cos \phi_1 + \cos \theta_f \sin \lambda_f \sin \phi_1 \\ \sin \theta_f \sin \phi_1 - \cos \theta_f \sin \lambda_f \cos \phi_1 \\ \cos \theta_f \cos \lambda_f \end{bmatrix} \quad (\text{A.8})$$

Using the coordinate transformation from  $S_1$  to  $S_h$  we obtain

$$\begin{aligned} x_h^{(1)} &= A_1 \cos \mu_1 + B_1 \sin \mu_1 \\ y_h^{(1)} &= A_1 \sin \mu_1 - B_1 \cos \mu_1 \\ z_h^{(1)} &= q_f \cos \theta_f \cos \lambda_f - \frac{a_f}{\cos \lambda_f} + b_f \cot \theta_f \tan \lambda_f \sin \lambda_f \\ &\quad + r_1 \phi_1 \tan \lambda_f \end{aligned} \quad (\text{A.9})$$

$$[n_h^{(1)}] = \begin{bmatrix} \sin \theta_f \cos \mu_1 + \cos \theta_f \sin \lambda_f \sin \mu_1 \\ \sin \theta_f \sin \mu_1 - \cos \theta_f \sin \lambda_f \cos \mu_1 \\ \cos \theta_f \cos \lambda_f \end{bmatrix} \quad (\text{A.10})$$

Here

$$\begin{aligned} A_1(\theta_f) &= q_f \sin \theta_f - b_f + r_1, \quad B_1(\theta_f) \\ &= (q_f \cos \theta_f - b_f \cot \theta_f) \sin \lambda_f, \quad \text{and } \mu_1 = \phi_1 - \phi'_1 \end{aligned} \quad (\text{A.11})$$

Equations (A.9) and (A.10) with a fixed value for  $\phi'_1$ , represent in the coordinate system  $S_h$ , surface  $\Sigma_1$  and the unit normal to  $\Sigma_1$ . These equations with different values for  $\phi'_1$ , represent in  $S_h$ , a family of surfaces  $\Sigma_1$  and the unit normals to these surfaces.

The derivation of equations for gear 2 surface  $\Sigma_2$  and its unit normal is based on similar considerations. We may represent these equations in  $S_f$  as follows:

$$\begin{aligned} x_f^{(2)} &= A_2 \cos \mu_2 - B_2 \sin \mu_2 + C \\ y_f^{(2)} &= -A_2 \sin \mu_2 - B_2 \cos \mu_2 \\ z_f^{(2)} &= q_p \cos \theta_p \cos \lambda_p - \frac{a_p}{\cos \lambda_p} + b_p \cot \theta_p \sin \lambda_p \tan \lambda_p \\ &\quad + r_2 \phi_2 \tan \lambda_p \end{aligned} \quad (\text{A.12})$$

$$[n_f^{(2)}] = \begin{bmatrix} \sin \theta_p \cos \mu_2 + \cos \theta_p \sin \lambda_p \sin \mu_2 \\ -\sin \theta_p \sin \mu_2 - \cos \theta_p \sin \lambda_p \cos \mu_2 \\ \cos \theta_p \cos \lambda_p \end{bmatrix} \quad (\text{A.13})$$

Here

$$\begin{aligned} A_2(\theta_p) &= q_p \sin \theta_p - b_p - r_2, \quad B_2(\theta_p) \\ &= (q_p \cos \theta_p - b_p \cot \theta_p) \sin \lambda_p, \quad \text{and } \mu_2 = \phi_2 - \phi'_2 \end{aligned} \quad (\text{A.14})$$

The nominal value of the center distance is  $C = r_1 + r_2$ .

**Acknowledgement:** Originally published in *Journal of Mechanisms, Transmission and Automation in Design*, Dec., 1985. Reprinted with permission of American Society of Mechanical Engineers. Paper No. 84-DET-175.

## Cutting Fluid Selection and Process Controls for the Gear Manufacturing Industry

Ike Tripp, Jr.  
Etna Products, Inc.  
Chagrin Falls, Ohio

### Introduction

The last decade has been a period of far-reaching change for the metal working industry. The effect of higher lubricant costs, technical advances in machine design and increasing competition are making it essential that manufacturers of gears pay more attention to testing, selecting and controlling cutting fluid systems. Lubricant costs are not a large percentage of the process cost relative to items such as raw materials, equipment and labor, and this small relative cost has tended to reduce the economic incentive to evaluate and to change cutting fluids. Nevertheless, one of the largest factors in lost production during gear manufacturing is excess tool wear, tool failure and subsequent product rejection. In this day and age of economic war of survival, it has become essential to consider and to evaluate new cutting fluids with an eye towards increasing tool life, improving overall productivity and product quality and lowering costs.

### Gear Cutting and Finishing

A wide variety of manufacturing techniques are used to manufacture gears. Specifically, this article addresses the selection and process controls for the fluids used for gear hobbing, gear shaping and hard gear finishing.

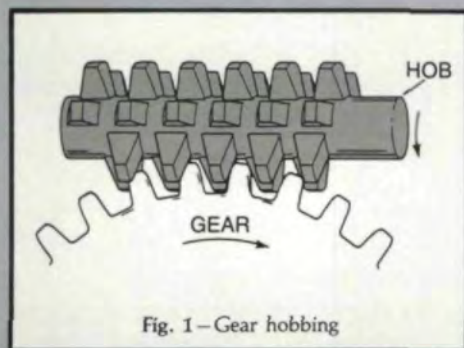

Fig. 1—Gear hobbing

The cutting tool used in gear hobbing is called the "hob". (See Fig. 1.) The majority of hobs are cylindrical in form and greater in length than in diameter. The cutting teeth on the hob are arranged in

a helical thread corresponding to the thread of a worm. As the hob rotates in timed relationship with the gear blank, each row of teeth successively cuts the next portion of the gear tooth-space. The cutting action is continuous in one direction until the gear is completed.

Conversely, the gear shaping method operates on the principle of two gears rolling in mesh. In molding generating processes, a gear-like cutter called a shaper tool is rotated and reciprocated in the correct ratio with a gear blank. (See Fig. 2.) The gear blank rotates while the cutter rotates and reciprocates to provide the cutting action. The shaper only cuts in one direction so relief is provided for the return stroke.

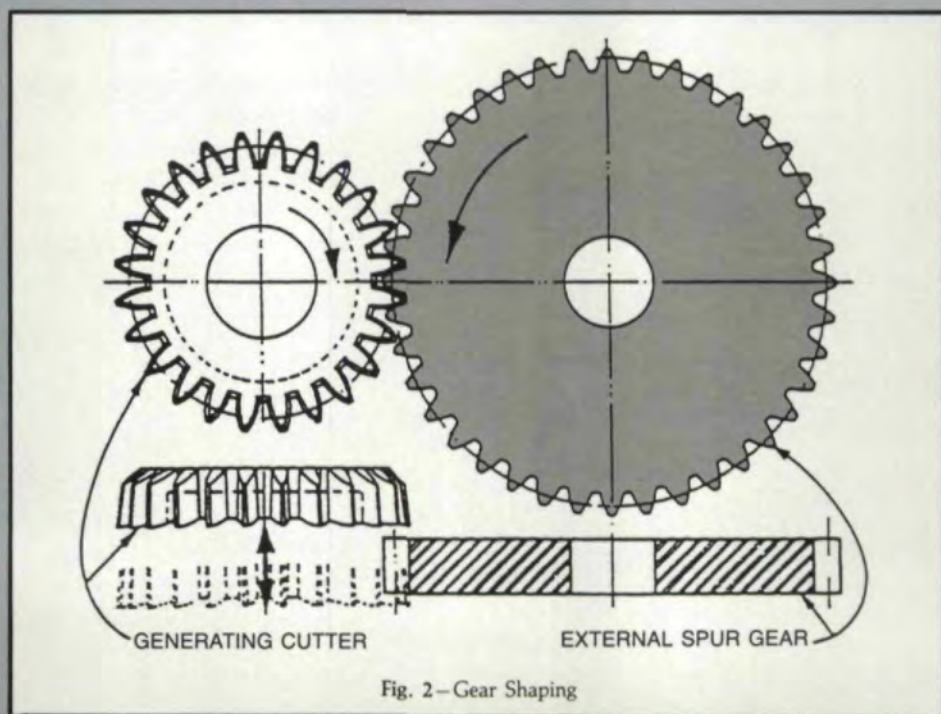

Fig. 2—Gear Shaping

### AUTHOR:

MR. IKE TRIPP, JR. is vice president and general manager of Etna Products, Inc. He has been with the company since 1974, and is the author of over 30 technical papers on industrial metalworking compounds. He is a member of ASLE, ASM, the Wire Association and SME.

Hard gear finishing is a process which uses either generative grinding or formed wheel grinding to finish the flanks of parallel axis spur or helical gears after they have been hardened by heat treatment. The hard gear finishing technique usually removes .002/.0025" from each side of the gear teeth.

In the form grinding process, the grinding wheel has a profile mirroring the tooth space between two adjacent gear teeth. As the formed wheel moves between the teeth of the gear, it removes excess stock.

There are several types of machines and tool configurations used in the generative grinding process. These processes either use a cutting tool designed as a spur or helical gear, which grinds the gear using the shaving or gear shaping principle, or a shaper cutter tool that uses a skiving principle or a worm type finishing tool similar to a worm type gear grinding wheel.

Recently, grinding wheels plated with cubic boron nitride (CBN) have been used in place of dressable, conventional abrasive grinding wheels. CBN is a synthetic crystalline material that is very wear resistant, and it has pronounced cutting edges because of its cubic shape. CBN applied by the electroplating process is considered the best for form gear grinding. CBN is very expensive, and its use dictates the need for improved coolants delivered at higher flow rates than used with conventional wheels.

### Theory of Lubrication

The aim of fluids used in cutting and grinding operations is to provide cooling and lubrication.

Gear hobbing and gear shaping are metal cutting operations that generate chips. More than 97% of the cutting work appears as heat. Fig. 3 illustrates

a two dimensional view of metal cutting. Of the heat generated, about two-thirds is expended in sticking friction in the shearing zone, and one-third is expended in sliding friction at the tool/chip and tool/flank interfaces. The action of the fluid is to lower the heat generated in these two zones, and the lubricant portion of the fluid reduces friction at the tool/chip and tool/flank interface.

A fluid used in hard gear grinding operation functions very much like a cutting fluid, but there are very pronounced differences between the dynamics of the processes. Gear grinding involves negative rake tool angles and random orientation of cutting surfaces. The temperatures and surface feeds are also higher. Most of the heat of deformation is carried into the workpiece so a gear grinding fluid must act to reduce grinding forces, which reduces heat generation. The cooling function of the fluid is considered secondary, but it is still important to the success of a hard gear finishing operation.

Fluids used for gear cutting and grinding must exhibit a number of other properties. They must not be adversely affected by metallic contaminants or tramp oils that can enter a lubrication system. They must not leave excessive residue on the surface of a gear to be subsequently heat treated, and they should aid in the production of a gear that has the desired properties — surface finish, runout, etc.

The study of the subject of wear between two materials in motion relative to one another is very complex. A number of parameters influence wear. Some of these include the shape of the contacting bodies, applied load, relative velocity between the surfaces, surface roughness, the elastic and plastic properties of the contacting materials (particularly those of the surface layers), and

the environment of deformation.

### Types of Cutting Fluids

A number of gear cutting and grinding fluids meet the requirement of providing adequate lubrication. This range of availability was not always present, as lubricant research and development was once a black art with few practitioners. Now, through scientific research and the cooperative efforts of vendors and buyers, lubricant development, application and behavior is becoming a science.

For the purposes of this article, lubricating fluids have been classified as either oil-based or water emulsifiable.

**Oil-Based Fluids.** Oil-based fluids are used for gear cutting and hard gear finishing where water emulsifiable compounds do not have the film strength or wetability to produce acceptable tool life or surface finish. Oil-based fluids are generally compounded with the following items:

1. Mineral oils, either naphthenic grade that have a saturated ring type structure, or paraffinic grade, which have a straight or branched chain structure.
2. Mineral oils blended with polar additives, as the oils themselves are nonpolar. The function of the polar additive is to affect the wetting of the metal surface at the tool/workpiece interface by reducing the interfacial tension between the mineral oil carrier and the gear blank. A polar additive has a sort of magnetism for the metal due to its molecular structure.

Polar active additives come from several sources. Animal fats and oils are derived by rendering the fatty tissues of animals such as cattle, pigs and sheep. Vegetable fats and oils are derived by

Fig. 3—Two-dimensional metal cutting diagram

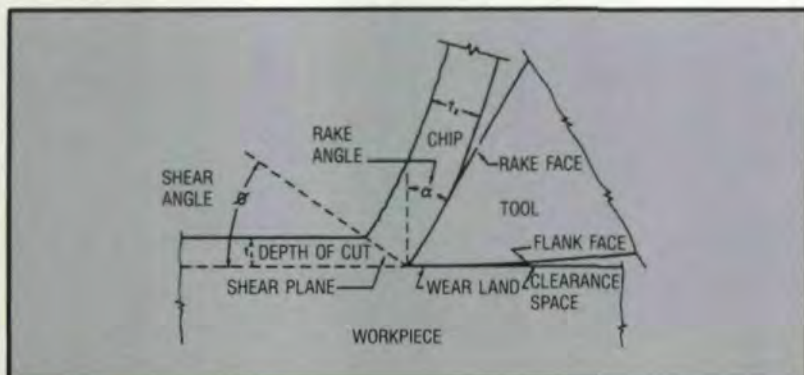

Table 1 — Coolants Grades by Contents

	FERROUS	NON-FERROUS
HEAVY DUTY	2-5% SULPHUR AND/OR 10-15% CHLORINE WITH 20-30% FAT	UP TO 40% FAT POSSIBLY 2-4% CHLORINE
MEDIUM DUTY	5-9% CHLORINE 5-15% FAT	10-20% FAT
LIGHT DUTY	3-5% FAT	3-5% FAT
SEMI-SYNTHETIC	SEE MEDIUM DUTY	SEE MEDIUM DUTY
SYNTHETIC	NEW E.P. ADDITIVES	NEW E.P. ADDITIVES

\*Sometimes 1-2% Phosphate



crushing and rendering the fruits of plants such as palm or coconut trees. Marine fats and oils are derived from crushing and rendering the fatty tissues of fish.

The mineral oils and polar additives are then often compounded with supplemental polar additives, which act as extreme pressure agents. The primary extreme pressure agents utilized are sulfur, chlorine or phosphorous. When subjected to the elevated temperatures at the tool/workpiece interface, these extreme pressure additives react to form an organo-metallic film which minimizes friction and lowers heat generation.

*Water Emulsifiable Fluids.* Water emulsifiable fluids are defined as those where water is the continuous phase. Basically, water emulsifiable fluids combine the cooling properties of water with the lubricating properties of oil and/or various chemicals.

Over the years, a good deal of jargon has evolved in the industry to describe water emulsifiable fluids for the gear manufacturing industry. Water miscible or emulsifiable lubricants are available in many forms. They can be classed based on their components, performances and appearance.

*Water soluble oils*, sometimes called emulsions or water miscible fluids, are made by blending oil, either paraffinic or naphthenic, with emulsifying agents, so the oil forms small droplets called micells, which range in size from .0002" to 0.00008" in diameter when mixed with water. The emulsion appears milky as the particles of oil reflect almost all incident light, making them opaque. Soluble oils are subdivided into light, medium and heavy grades, depending on the components used in their formulation. (See Table 1.)

*Semi-synthetic fluids* are mixtures of emulsifiers and surface-active chemicals and have a low oil content of 10% to 25%. A typical soluble oil contains 45% to 70% oil. Because a semi-synthetic contains less oil than a water soluble lubricant, it can vary from being translucent to completely clear, as the micells range in size between .000004" and .000001" in diameter. They can only be seen under an electron microscope.

*Synthetic solutions* are almost always clear, as the particle size of the surface-

active agents and chemicals used in the formulation of the product are small enough to transmit almost all incident light. True synthetics contain no mineral oil, and each component used in the formulation is soluble in water on its own. The particles are smaller than .00000004" in diameter and cannot be viewed under any microscope.

Generally most of the water emulsifiable fluids available contain a naphthenic oil made soluble through the use of emulsifiers or surface-active agents.

The formulation of a commercially acceptable product depends on investigating hundreds of emulsifiers which can be classed as:

1. Anionic—These are emulsifiers whose electrolytic properties are based on the formation of anionic ions. Examples include sulfonated polyester or sulfonated castor oils.
2. Cationic—These are emulsifiers whose electrolytic properties are based on the formation of cationic ions. Examples include organic salts

## A CUT ABOVE THE REST

# DAVIS KEYSEATER

**F**or saving time and money, nothing outperforms the Davis Keyseater:

- It cuts keyways and slots faster than hand broaching.
- Fast set up time to match today's more frequent changes and smaller production runs.
- Economical and easy to operate.
- Ideal for all types of keywaying: maintenance, jobbing, production in a cell.
- Versatile enough to accommodate simple fixtures for external slotting.

**Priced from \$5,775, there's no comparison.**

**HANSFORD**  
**DAVIS KEYSEATER**

Hansford Manufacturing Corp.  
3111 Winton Road South  
Rochester, New York 14623  
(716) 427-0660

CIRCLE A-15 ON READER REPLY CARD

or polyethoxylated amines.

3. Non-ionic — These emulsifiers do not behave as electrolytes and do not ionize in water. Examples include ethoxylated vegetable oils.

Surface-active or polar extreme pressure additives are also added to the formulation of a water emulsifiable fluid to wet out and to penetrate the tool/workpiece interface. These agents reduce the interfacial tension between the water, lubricant and the metal. The polar additives have an affinity for the metal substrate and form an organo-metallic film which provides lubrication by reducing friction at the tool/workpiece interface. There are a variety of oils, fats, waxes and synthetic polar additives such as esters or complex alcohols used as surface-active agents.

**Fluid Selection.** A number of factors affect the type of fluid used in a gear hobbing, gear shaping or hard gear finishing operation. The primary criteria for selection of material, which determines machinability, speed and severity of operation and the acceptability of a fluid, are all interrelated. Table 2 illustrates the additives utilized when severity is compared to difficulty of machinability.

The primary fluids used on CBN grinding of hard gears are oil-based because grinding wheel wear has been found to be related to the temperature of the wheel matrix. As the temperature of the wheel matrix increases, the wear of the wheel increases. Testing with both oil-based and water-based fluids has shown that oil-based fluids provided better lubricity and lower temperatures of the wheel matrix.

Another factor that influences grinding wheel life is the cleanliness of the oil-based lubricant. The hard gear finishing process generates very fine swarf which must be removed so as to maximize wheel life and improve surface finish. The most effective method of filtering a grinding oil-based fluid is a horizontal plate pre-coat filter. The filtering capability of a typical pre-coat filter is between one and three microns.

#### Testing and Process Controls

Selecting the appropriate lubricant for gear hobbing, gear shaping or hard gear finishing is very difficult. Effective tests

for screening the wide variety of candidate fluids must be developed. These compounds vary greatly in their chemical and physical properties, and because of the critical need for optimum tool life, any variation in the physical and chemical properties of a given fluid becomes important. To assure the reliability of a given fluid, many lubricant manufacturers perform a number of tests to assess its physical, chemical, metallurgical and human compatibility. These tests yield data that can be used to screen fluids prior to in-plant testing.

**Physical Laboratory Tests.** These lab tests are designed to simulate as closely as possible actual production conditions and to generate data as to the reliability of a fluid under actual conditions of use.

1. Stability of a neat oil. The product should be stable under normal and adverse conditions. The following tests can point out stability problems: Place an eight ounce sample in a closed sample bottle and allow it to stand 21 to 30 days at ambient temperature. Monitor for any changes; i.e., separation, gelling. To test the effects of freezing and thawing, put an eight ounce sample of the neat oil in a closed container and place the sample in a freezer for 24 hours. Thaw, then refreeze for 24 hours and thaw again. Examine the neat oil for changes; i.e., separation, sedimentation.
2. Nonferrous corrosion. One test for nonferrous corrosion is to place a 30 ml sample of the neat fluid in a 100 ml beaker and then to put a properly abraded and cleaned copper strip in the beaker, heat to 220 F for three hours and check for staining on the strip.

The effect of a cutting and grinding fluid compound on the gear being manufactured must be assessed for two reasons.

  - a. Some of the extreme pressure agents, such as sulfur, used in these compounds might corrode the gear or the nonferrous parts like valve pipes and bearings in the actual manufacturing machine, as well as possibly adversely affecting the finished gear.

Table 2

SEVERITY OF METAL-WORKING OPERATION ↑	BROUCHING SLOW SF/M	ACTIVE SULFUR	SULFUR & CHLORINE	ACTIVE
		LESS ACTIVE		SULFO-CHLORINATED
		INACTIVE	LOW CHLORINE	INACTIVE
	HIGH SF/M	FAT	FAT & CHLORINE	HIGH CHLORINE
	HIGH SPEED CUTTING			
		NON-FERROUS FREE MACHINING	DIFFICULTY OF MACHINABILITY	STAINLESS AND HIGH ALLOY

- b. Tests have indicated that it is possible for sulfur used in cutting fluids to react with titanium nitride coatings or CBN coatings, causing erosion of the coating and thus lowering tool life.
3. Load carrying properties. The Four Ball Test and the Falex Test were developed to determine the load carrying properties of cutting and grinding fluids.
    - a. Shell Four Ball EP Test ASTM D-2596 and D-2783. The Shell Four Ball Test consists of four 1/2" diameter balls arranged in the form of an equilateral tetrahedron. The lower three balls are held immovably in a clamping pot to form a cradle in which the fourth ball is caused to rotate about a vertical axis. The fluid under test is held in the clamping pot and covers the area of contact of the four balls. During the test, scars are formed on the surface of the stationary balls, and the diameter of the scars depends upon the load, duration, speed of rotation and type of fluid. The scars are measured by a microscope having a calibrated grid at the completion of the test.
    - b. An alternative to the Four Ball Test, the Falex test machine provides a rapid means of measuring the load carrying capacities

and wear properties of a given fluid. The test consists of rotating a test pin between two loaded journal V-blocks immersed in the fluid sample. The test pin is driven by a 1/3 hp motor at 290 rpm, and the journals are loaded against the test pin by means of a spring gauge micrometer. The Falex machine is also an extreme pressure tester, and can be used to conduct a wear test, ASTM D-2670, to assess the effectiveness of a given fluid.

4. Cast iron corrosion. This test is important as the fluid must be tested to assess its effect on the interior ferrous parts of the gear cutting or grinding machine. A chip test or a Q-Panel test conducted with a Cleveland Condensing Humidity Cabinet can assess the effect of a given compound.

*Chemical and Metallurgical Compatibility.* A candidate fluid must also be considered from a chemical and metallurgical standpoint. The gear hobbing and gear shaping process and subsequent hard gear finishing process involve the exposure of unprotected, unoxidized metal surfaces to the chemical components of a lubricating fluid at elevated temperatures and pressures. Due to the elevated temperature and pressure, it is important to assess the effects of those reactions prior to in-plant testing.

1. Turbine oil oxidation test ASTM D-943. This test predicts the oxidation life of hydraulic oil, turbine oil, and metalworking oils. The test depends upon the catalytic effect of metals at elevated temperatures in the presence of water to accelerate the rate of oxidation. The degree of oxidation is determined by an increase in the acid number of the oil.
2. Rotary bomb oxidation test ASTM D-2272. The rotary bomb oxidation test is a more rapid method of comparing the oxidation life of fluids in similar formulations.
3. Turbine oil rust test ASTM D-665. Contamination of gear manufacturing fluids with water can produce

rapid rusting of ferrous parts unless the oils are adequately treated with inhibitor compounds. The ASTM D-665 rust test is designed to measure the ability of industrial oils to prevent rust.

#### Process Controls for Oil-Based Compounds

There are many variables, such as feeds, speeds and operator expertise, involved in the gear hobbing, gear shaping and hard gear finishing process; therefore, it follows that any variation in the effectiveness of a given lubricating fluid will become important to overall productivity and profitability. To assure the long term reliability of each compound, it is important to monitor and to maintain certain controls for straight oil compounds.

1. Handling and storage — Oils should be stored at ambient temperature. If the oil is frozen, it should be thawed and mixed prior to use.
2. Temperature — It is important to maintain the temperature of an oil-based fluid at ambient temperature; i.e., approximately 65° - 75°F, or at least to maintain the temperature below 125°F if it is not possible to keep it lower.

Excessive heat causes oxidation reactions which show up as sludge formation, varnish formation and the formation of acidic by-products which also cause corrosion. These by-products minimize lubricity. Excessive oxidation can be controlled by maintaining correct operating temperatures.

3. Viscosity — The viscosity of a straight oil can change with time because of a number of factors, such as tramp oil leaking into the system or chemical reactions in the oil due to heat and oxidation. Viscosity is an important indication of the condition of the oil.
4. Water and solids content — Proper filtration is necessary for good tool life and product quality, as excess metal fines can plug supply lines or catalyze chemical reactions to form sludge or varnish.

Water at quantities greater than

0.01% by volume can cause a problem because it turns to steam at the tool/workpiece interface, and this steam blanket minimizes lubricity.

The level of solids can be controlled through filtration, and the level of solids and water should be checked periodically to monitor the condition of the oil.

5. Acid number — In oil-based fluids the acid number denotes the level of acid-type components that influence the behavior of the fluid. When oil is oxidized, the acid number increases and adverse chemical reactions, such as the formation of insoluble metallic soaps, can occur. Therefore, it is important to monitor the acid number.
6. Additive content — The additives used to blend gear cutting and grinding fluids are depleted through use; therefore, additive levels must be carefully monitored. The load bearing capacity of a fluid is related to the concentration of the additives.
7. Record keeping — A logbook should be maintained to record the test data. This logbook can be used to track the performance of the oil in a system.

*Quality Control of the Operating Emulsified Fluid.* To effectively maintain an operating emulsifiable fluid, the operator is advised to observe several basic points.

1. Handling and storage — A good emulsion starts with good storage conditions for the neat oil. The complex chemical make up of most emulsifiable fluids requires the storage of neat oil at ambient temperatures. If the neat oil is frozen, it should be allowed to return to ambient temperature prior to mixing the emulsion.
2. Mixing — As a general rule, most emulsifiable fluids are added to water in the reservoir while agitating to form the emulsion, but the supplier should always be consulted for correct mixing instructions.
3. Water source and composition — Because water is a major compo-

ment of an operating emulsifiable fluid, its quality plays a large part in operating effectiveness. The life of the emulsion in the reservoir, foam characteristics, tool life and product quality are all influenced by the quality of the water. Make-up water should be as pure as possible. Distilled or deionized water is ideal, as hard water, which is contaminated with minerals and dissolved salts, adversely affects the emulsion. Basically, the minerals and salts can cause corrosion problems in the equipment, and they can react with the emulsifiers in the fluid to produce hard water soaps which adversely affect emulsion stability and lubricity.

A reservoir supplying a gear cutting or grinding machine is hot and aerated, which causes the water to evaporate. As this occurs, dissolved salts and minerals increase in concentration, and, thus, evaporation accelerates the formation of hard water soaps. To counteract this problem, one should consider the use of deionized water, boiler water condensate or softened water to make up water lost to evaporation.

4. Bacteria — In many systems, bacteria can become a problem because bacteria degrade the emulsion by digesting the emulsifiers and fats. This problem becomes more severe as the bacteria secrete acidic wastes which adversely affect the pH of the system. Changes in pH affect emulsion stability and lubricity. There are a number of bactericides available to control the problem.
5. Temperature — The temperature of emulsions used to cut or grind gears must be kept between 100° and 130° F. This is important for several reasons.
  - a. If the emulsion is too cold, it may not be fluid enough to be pumped to the tool/workpiece interface. This could "starve" the tool and adversely affect tool life and product quality.
  - b. If the emulsion overheats, the high temperature degrades the

emulsifier package, which affects stability. The higher temperature also does not allow for efficient heat transfer at the tool/workpiece interface. This lack of cooling can result in poor tool life and product quality, and oxidation of the oil phase of the emulsion. As a corollary to problems caused by heat, the rate of chemical reaction is increased and the formation of insoluble metallic soaps is accelerated.

6. pH — pH is a measure of the acidity-alkalinity of a fluid. pH is controlled by the content of the polar additives, such as fatty acids. As detailed earlier, these polar additives are responsible for a fluid's lubricity. If the pH falls because of exhaustion of polar additives, lubricity will be diminished; whereas, if the pH rises too high, the emulsion will become unstable. Since the fatty acids affect pH, it is important to measure them and maintain pH at recommended operation levels. It is best to maintain pH with regular additions of neat oil.
7. Concentration — Maintaining the correct concentration of neat oil in the reservoir is important because tool life and product quality will suffer if the lubricity of the fluid is excessively diluted. Concentration can be monitored by the Babcock Method or by a hand-held refractometer.
8. Filtration — A clean fluid is essential to maintaining the emulsion, tool life and product quality. Gear manufacturing fluid compounds can be contaminated rapidly with things such as oxide, chips, tramp oil from lubricating or hydraulic systems and even items such as food, rags and mill dirt. If these contaminants are not removed from the system, the effective life of the fluid is shortened and product quality and productivity falls. To overcome the inherent problems associated with disposal and replacement of lubricants, it is im-

portant to filter the emulsion and extend its useful life.

9. Foaming — Care must be taken to maintain pump seals so as to minimize pump cavitation and reduce foam. Excessive foam minimizes effective cooling and lubrication at the tool/workpiece interface.
10. Record keeping — A log book which can be used to record additions of neat oil, temperature, concentration, pH, etc. is important. The log book is a handy reference, providing a record of the operating systems.

### Testing in the Plant

Several steps are required to insure a successful in-plant testing program.

1. Obtain management commitment for a testing program.
2. Select a person to coordinate testing. This person will serve as an in-plant consultant and also promote education of employees as to fluids.
3. Identify problem areas and initiate a program to evaluate lubricating fluids.
4. Select vendors who are up to date relative to the OSHA Hazard Communications Program.
5. Monitor direct costs such as cost per gallon, cost per pound and cost of additions.
6. Monitor indirect costs, such as maintenance additives, cost of disposal and dumping frequency.
7. Find out if oil-based compounds can be reclaimed to avoid problems with disposal.
8. Monitor tool life by considering original cost and reconditioning cost.
9. Consider finished product quality versus raw material utilized.
10. Monitor the condition of the fluid and of the gear manufacturing equipment relative to the fluid being used.
11. Evaluate the test program and report results to management.
12. Implement changes where the evaluation justifies the need.

13. Expand and maintain the testing program so as to be prepared for unexpected problems.

14. Be receptive to change as new technology supercedes the old.

After the testing program has been established, it is important to have some means of measuring the effectiveness of a given fluid when it is used on gear hobbing, gear shaping or hard gear finishing operations. Several test techniques are available that go beyond the simple tool life test.

**"On-Line" Monitoring** — Today's state-of-the-art CNC controls allow "on-line" optimizing and monitoring of cutting conditions during machine operation. The information can be collected on a peripheral microcomputer and analyzed relative to changes in cutting fluids. At the same time, new electronic gear checking equipment can be used to monitor such things as changes in pitch, involute and lead given changes in cutting fluids or grinding fluids.

**Statistical Quality Control** — With the advent of statistical quality control, it is now possible to monitor product quality relative to changes in the fluids used on a given gear hobber, gear shaper or hard gear finishing machine. The quality of the finished gear can vary significantly based on the type of fluid being tested within the equipment.

**Transducers for Force and Torque Measurement** — A multi-component transducer can be used for analysis of grinding. This instrument provides a measure of two forces, the vertical force and the vertical torque. In a typical application, this instrument would be mounted on the work table of the grinder and the test piece attached in a fixture on the top of the instrument. The ratio of the vertical force and the feed force is essentially a measure of the grinding fluid's effectiveness.

### New Developments

There are several new developments in the field of lubricating fluids for the gear manufacturing industry.

Microemulsions are generally clear like synthetic solutions. Really an offshoot of semi-synthetics, microemulsions contain a small amount of mineral oil in addition to the other components which are soluble in water. The difference is that

microemulsions are formulated to have smaller micells than semi-synthetic emulsions; hence, they have more dispersed particles. The small micells allow almost all incident light to be transmitted. The small micells mean microemulsions are generally more stable than soluble oils or semi-synthetics. Microemulsions have a number of other advantages including low tendency to foam, non-corrosive properties, high detergency and wet out, reduced tendency to form insoluble soaps, easy mixability and longer life.

Synthetic hydrocarbons compounded with suitable diester fluids are yielding new high-molecular-weight synthetic fluids with superior viscosity index and shear stability compared to conventional polymer-based viscosity improvers in hydrocarbon base stock. Synthetic hydrocarbons exhibit excellent oxidation and hydrolytic stability and have a very high film strength. These synthetics are more resistant to breakdown under high temperature, and they are now being blended into a number of different gear cutting and grinding oils. Synthetic hydrocarbons will probably not come into more widespread use until their cost decreases.

### Conclusion

This article has reviewed lubrication theory, fluid formulation, testing and process controls. Particular emphasis was placed on factors affecting fluid selection, classification and testing, to shed light on the chemical background and maintenance of gear cutting and grinding fluids. Rapid advances in gear manufacturing technology, combined with customer demands for improved product quality at lower cost, are making it essential that manufacturers of gears obtain maximum utilization from every fluid used in a plant. Careful attention to the techniques outlined in this article can improve fluid maintenance through systematic checks. The attention paid to lubrication should yield improved product quality, higher productivity and lower overall costs.

### References:

1. SPRINGBORN, R.K., et al. *Cutting and Grinding Fluids: Selection and Application*. ASTME, Dearborn, MI 1967.
2. SCHEY, T.A. *Metal Deformation Processes: Friction and Lubrication*. Marcel Dekker, Inc., New York, NY, 1970.

3. HIXSON, D.R. "Countervailing Coolant Forces," *Manufacturing Engineering*, October, 1980. p. 96.
4. REDGARD, M.P. "Cutting Fluid Emulsions," *Industrial Lubrication and Tribology*, July/August, 1979. pp. 149-152.
5. KIPP, E.M. "Tribology Notes," *Industrial Lubrication and Tribology*, September/October, 1980. pp. 168-171.
6. JENTGEN, R.L. *The Key Role of Lubrication in Metal Deformation Processes*. SME, Detroit, MI, 1972.
7. SCHEY, JOHN A. *Tribology in Metalworking: Friction, Lubrication and Wear*. American Society of Metals, Metals Park, OH, 1983.
8. *Federal Register*, "CFR 1910:1200 Hazard Communication," Vol. 48, No. 228, Friday, November 25, 1983.
9. FELLOWS CORP. "Generating and Checking Involute Gear Teeth," *Gear Technology*, May/June, 1986. pp. 38-48.
10. AINOURA, M., SAKURAGI, I., YONEKURA, M., NAGANO K. "A Research on High-Speed Hobbing with the Carbide Hob," *Journal of Mechanical Design*, June, 1977. pp. 1-10.
11. MONCRIEFF, A.D. "Hard Gear Finishing." *Proceedings of AGMA Manufacturing Symposium*, April, 1985. pp. 1-23.
12. MAHAR, R. "Progress in CBN Production Grinding." *Proc. Super Abrasives '85*. Chicago, IL, 1985.
13. LANGE, J. "Gear Grinding Techniques for Parallel Axes Gears," *Gear Technology*. March/April, 1985. pp. 34-48.
14. BOOTHROYD, G. *Fundamentals of Metal Machining and Machine Tools*. McGraw-Hill.

### Appendix A

*Human Compatibility.* Cutting fluids must be assessed not only from a physical, chemical and metallurgical standpoint, but also from the point of view of operator acceptability and safety. Health and safety considerations are discussed in Appendix A.

After the physical, chemical and metallurgical studies have been completed, it is important to assess the fluid's acceptability from a operator's standpoint. The oil-based or water-based fluid of choice should not cause physiological problems. It is important to recognize that no material is completely hazard-

(continued on page 48)

## VIEWPOINT

(continued from page 10)

### Shot Peening

I always take pleasure in learning new techniques which appear in "Gear Technology". The publication is very helpful to the communication of engineering information among investigators, and I am proud of being one of the authors of articles.

Recently, I read the paper by Mr. N.K. Burrell of Metal Improvement Co. titled "Improved Gear Life Through Controlled Shot Peening", which appeared in the September/October issue, p.12. We are also studying the bending strength of shotpeened carburized gear teeth; therefore, I am very interested in the coverage measurement method "Peenscan Process" in his paper. I understand the method is practical and useful for the control of shot peening as well as the measurement of coverage. I really hope to apply the Peenscan Process to our experiment, so I am anxious to have a copy of the specification "MIL-S-13165B" and further information on the coating material "Dyescan." For example, what is the address of the maker or dealer of Dyescan, the price, directions for use, etc.

Katsumi Inoue  
Tohoku University, Japan

### Editors Note:

Contact Ken Burrell at  
Metal Improvement Company, Inc.  
678 Winthrop Avenue  
Addison, Illinois 60101  
for further information.

### American Competitiveness

I want to commend you on your timely editorial, "The World—Our Market."

The competitiveness of American industry is linked inextricably to its ability to trade freely in world markets. Your editorial stressing the necessity of industry's competitive role in a world market faces the challenge of our changing world.

Thomas J. Lynch  
Regional Sales Manager  
Hearst Business Media Corp.  
IMN Division



# CNC GEAR HOBBER

WITH GENERAL NUMERIC 3MB/4B-6 AXIS CNC

## NO PROBLEMS

- No gears to change
- No limit switches to set
- No mechanical cycles to adjust

## JUST PRODUCTION

- 70% savings in set-up time
- Full range of canned cycles
- Pitch accuracies to AGMA 11

Full range of models up to 72" Dia. available.

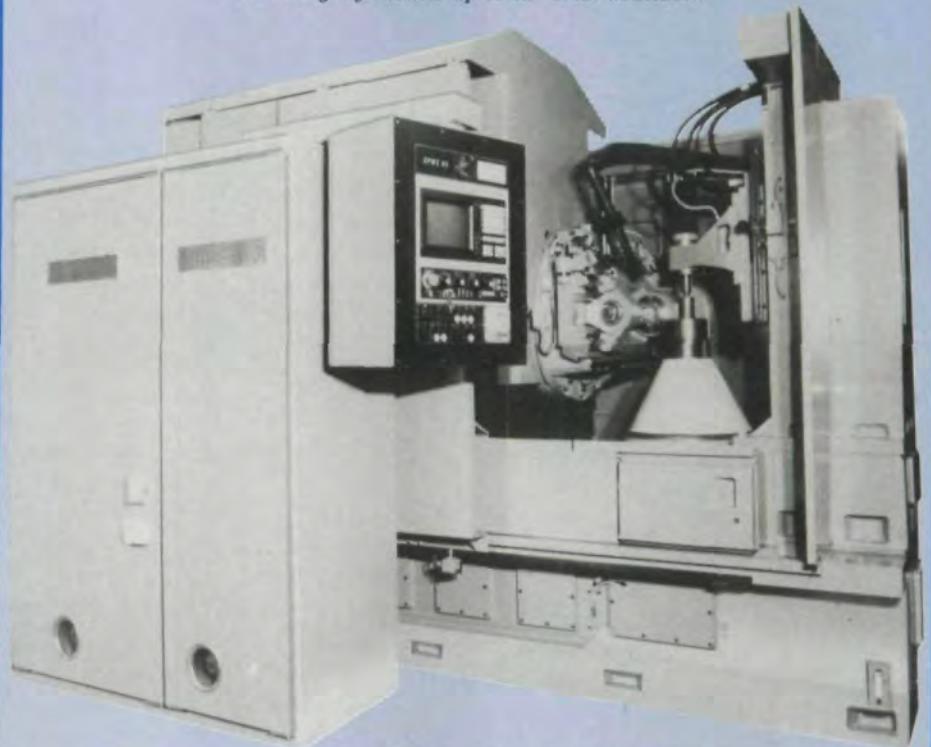

Model ZFWZ 05 CNC EZ 20.0" Dia. — 2.5 D.P.



## WMW MACHINERY INC.

570 Bradley Hill Road • Blauvelt, New York 10913  
Phone (914) 358-3330 - Gear Division, Chicago, IL (312) 364-4530

CIRCLE A-12 ON READER REPLY CARD

It is my view that open, free trade is one of the main engines of economic growth, prosperity and jobs.

Your publication is very slick and professional. Keep up the good work!

**Letters for this column should be addressed to Letters to the Editor, GEAR TECHNOLOGY, P.O. Box 1426, Elk Grove Village, IL 60007. Letters submitted to this column become the property of GEAR TECHNOLOGY. Names will be withheld upon request; however, no anonymous letters will be published. Opinions expressed by contributors are not necessarily those of the editor or publishing staff.**

## Longitudinal Load Distribution . . .

(Continued from page 19)

$$a_4 = -\frac{K(1+f+y')^3 p_n}{6} + a_2$$

$$a_5 = -\frac{K_S(1+f+y')^2 p_n}{2} - \frac{K_S(f+y') p_n}{6} - \frac{\delta_L - \delta_R}{1}$$

$$a_6 = \frac{K_S(1+f+y')^2 p_n}{6} + \delta_L$$

(A.3)

### (2) Torsional deflection

$$w_t = [J_S(1+f) + J(y-1-f)] p_n r_g^2$$

$$(1+f \leq y \leq 1+f+y')$$

$$w_t = [J_S(1+f) + Jy'] p_n r_g^2$$

$$(1+f+y' \leq y \leq 1+f+b)$$

where,  $K = \frac{64}{\pi E d_O^4}$ ,  $K_S = \frac{64}{\pi E d_S^4}$ ,  $J = \frac{32}{\pi G d_O^4}$ ,  $J_S = \frac{32}{\pi G d_S^4}$

(A.4)

$d_O$  : pitch diameter [mm]

$E$  : modulus of elasticity =  $2.06 \times 10^5$  N/mm<sup>2</sup>

$G$  : modulus of rigidity =  $7.92 \times 10^4$  N/mm<sup>2</sup>

$\delta$  : displacement of bearing [mm]

### Appendix B:

#### Effect of mesh stiffness on the load distribution factor

In the text the load distribution factors calculated by FEM were compared with the values in ISO 6336/I and AGMA 225.01. The latter standard was revised in 1982, and the gear design is now based on the new standard AGMA 218.01. The main effect of this revision in estimating the load distribution factor is in evaluating the mesh stiffness, surely the essential point of the problem. A brief discussion follows to clarify the effect of mesh stiffness on the load distribution factor.

The mesh stiffness  $G = 0.5 - 2 \times 10^6$  lb/in<sup>2</sup> was recommended for spur gears in AGMA 225.01, and the authors adopted as a mean value  $G = 1.2 \times 10^6$  to demonstrate that

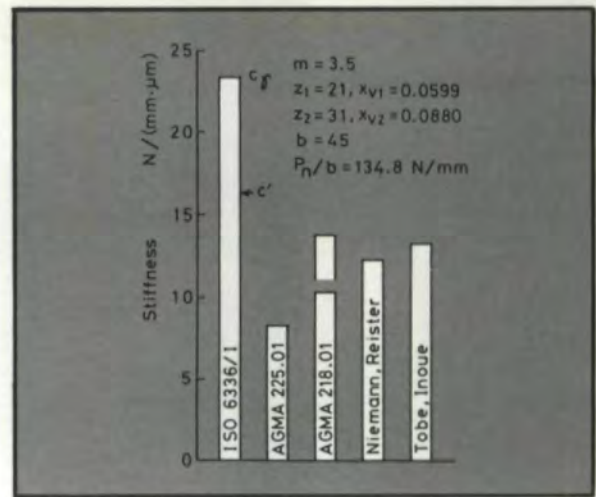

Fig. B.1—Mesh stiffness

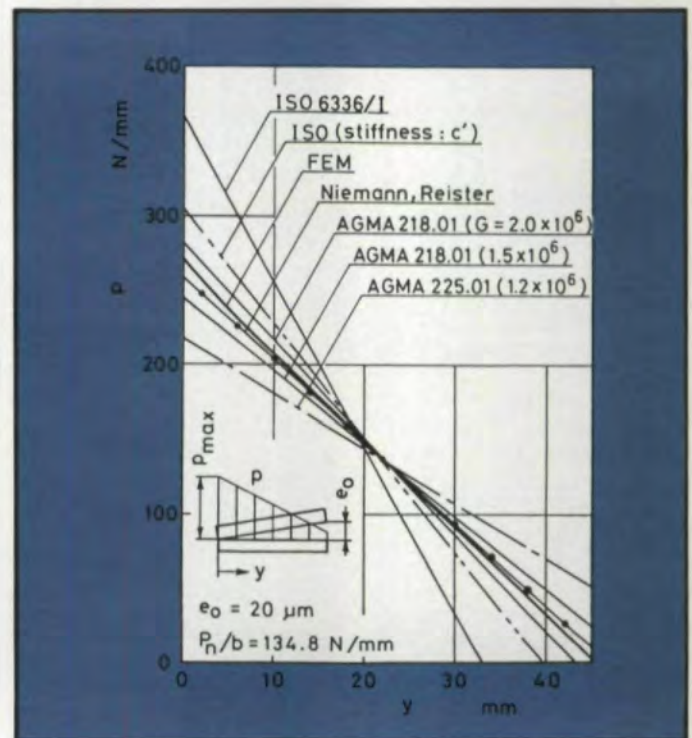

Fig. B.2—Comparison of Longitudinal Load Distribution

the load distribution factor differs from the factor calculated by FEM. The values are compared in Fig. 2 and Table 2. On the other hand, AGMA 218.01 recommends the stiffness  $G = 1.5 - 2 \times 10^6$ . These values compare well with the stiff-

Table B.1 Comparison of longitudinal load distribution factor

$P_n/b$ (N/mm)	FEM			Formula (13)			ISO 6336/I			AGMA 225.01			AGMA 218.01		
	200	400	600	200	400	600	200	400	600	200	400	600	200	400	600
$e_0 = 0 \mu\text{m}$	1.19	1.20	1.20	1.15	1.15	1.16	1.25	1.25	1.25	1.18	1.18	1.18	1.15	1.15	1.15
15 $\mu\text{m}$	1.39	1.15	1.07	1.36	1.13	1.05	1.69	1.22	1.06	1.33	1.16	1.08	1.40	1.13	1.04
30 $\mu\text{m}$	1.89	1.41	1.24	1.78	1.37	1.22	2.55	1.69	1.37	1.61	1.33	1.22	1.95	1.40	1.22

NOTE: AGMA 225.01:  $G = 1.2 \times 10^6$  IG/in<sup>2</sup>    AGMA 218.01:  $G = 2 \times 10^6$  IG/in<sup>2</sup>

ness obtained by Niemann and Reister's experiment as shown in Fig. B.1. They are also close to the stiffness calculated by FEM.

In ISO 6336/I, the mesh stiffness  $c_\gamma$ , the mean value of the total stiffness, is used to estimate the load distribution factor. Because of its definition,  $c_\gamma$  may be used to estimate a dynamic load, but it is not logical for the estimation of the load distribution. The single stiffness  $c'$ , which is approximately equal to the stiffness of a tooth pair in the phase of single pair contact, should be used instead, because the load distribution factor  $K_{H\beta}$  is used to evaluate a contact stress at the operating pitch point. Furthermore, the root stress is calculated for the worst loading condition (loading at the highest point of single tooth contact), and the formula uses the factor  $K_{F\beta}$ , which is related to  $K_{H\beta}$ . The stiffness  $c'$  is quite close to the stiffness calculated by FEM as shown in Fig. A.1.

The load distributions obtained from these stiffnesses are illustrated in Fig. A.2, which corresponds to Fig. 2a in the text. The load distribution obtained by AGMA 218.01 is fairly close to the result calculated by FEM. If the latter is regarded as accurate, the stiffness  $G = 1.85 \times 10^6$  is recommended in this case. Using  $c'$  makes the load distribution of ISO very close to the result by FEM. The comparison of the load distribution factors is summarized in Table B.1, which corresponds to Table 2.

#### References

1. First draft proposal ISO/DP 6336, Part I, ISO/TC 60(WG 6-2) 386E.
2. HAYASHI, K., "Load Distribution on the Contact Line of Helical Gear Teeth (1st Report, Basic Investigation)," *Trans. JSME*, Vol. 28, 1962, pp. 1093-1101. (in Japanese).
3. CONRY, T.F. and SEIREG, A., "A Mathematical Programming Technique for the Evaluation of Load Distribution and Optimal Modifications for Gear Systems," *Trans. ASME*, Ser. B, Vol. 95, 1973, pp. 1115-1122.
4. NIEMANN, G. and REISTER, D., "Einseitiges Breitentragen bei Geradzahnten Stirnrädern Messung, Berechnung und Verringerung der Ungleichförmigkeit der Lastverteilung," *Konstruktion*, Vol. 18, 1966, pp. 95-106.
5. TOBE, T. and INOUE, K., "Longitudinal Load Distribution Factors of Spur Gear Teeth," *Unabridged Text of Lectures of World Congress on Gearing*, Vol. 1, Paris, 1977, pp. 211-225.
6. TOBE, T. and INOUE, K., "Longitudinal Load Distribution Factor of Spur Gears Considering the Effect of Shaft Stiffness," *Proceedings of World Symposium on Gears and Gear Transmissions*, Vol. B, Dubrovnik-Kupari, 1978, pp. 371-381.
7. TOBE, T., KATO, M. and INOUE, K., "Bending of Stub Cantilever Plate and Some Applications to Strength of Gear Teeth," *Trans. ASME*, Vol. 100, 1978, pp. 374-381.
8. LUNDBERG, G., "Elastische Berührung Zweier Halbräume," *Forsch. Ing.-Wes.*, Vol. 10, 1939, pp. 201-211.
9. AGMA 225.01, 1967
10. WELLAUER, E.J., "An Analysis of Factors Used for Strength Rating Helical Gears," *Trans. ASME*, Vol. 82, 1960, pp. 205-211.
11. TOBE, T., KATO, M. and INOUE, K., "True Stress and Stiffness of Spur Gear Tooth," *Proceedings of Fifth World Congress on the Theory of Machines & Mechanisms*, Vol. 2, Montreal, 1979, pp. 1105-11.

This article was presented at the Century 2 International Power Transmissions & Gearing Conference, San Francisco, CA, August, 1980, and is available as ASME paper 80-C2/DET-45.



## ADVERTISERS' INDEX FOR GEAR EXPO '87

This index lists our advertisers who are exhibiting at Gear Expo '87. We will update this list and print a complete exhibitors list in our next issue.

Booth #530  
**AMARILLO GEAR COMPANY**  
 P.O. Box 1789  
 2401 Sundown Lane  
 Amarillo, TX 79105  
 (806) 622-1273

Booth #401  
**AMERICAN PFAUTER LIMITED**  
 925 E. Estes Avenue  
 Elk Grove Village, IL 60007  
 (312) 640-7500

Booth #429  
**ASME-GRI**  
 P.O. Box 353  
 N. Washington &  
 East-West Tollway  
 Naperville, IL 60566  
 (312) 355-4200

Booth #203  
**GEAR TECHNOLOGY**  
 The Journal of Gear  
 Manufacturing  
 1425 Lunt Ave.  
 Elk Grove, IL 60007  
 (312) 437-6604

Booth #220  
**JAMES ENGINEERING**  
 11707 McBean Drive  
 El Monte, CA 91732  
 (818) 442-2898

Booth #434 & 436  
**KLINGELNBERG CORP.**  
 15200 Foltz Industrial Pkwy.  
 Strongsville, OH 44136  
 (216) 572-2100

Booth #409  
**M & M PRECISION**  
 300 Progress Road  
 W. Carrollton, OH 45449  
 (513) 859-8273

Booth #323  
**MITSUBISHI HEAVY INDUSTRIES AMERICA**  
 873 Supreme Drive  
 Bensenville, IL 60106  
 (312) 860-4220

Booth #334 & 336  
**NORMAC**  
 P.O. Box 69  
 Arden, NC 28704  
 (704) 684-1002

Booth #305  
**STAR CUTTER COMPANY**  
 23461 Industrial Park Drive  
 Farmington Hills, MI 48024  
 (313) 474-8200



# CLASSIFIED

**Rates:** Classified Display—\$110 per inch (minimum 3") Type will be set to advertiser's layout or *Gear Technology* will set type at no extra charge. **Word Count:** 35 characters per line, 7 lines per inch.

**Payment:** Full payment must accompany classified ads. Mail copy to *Gear Technology*, P.O. Box 1426, Elk Grove Village, IL 60007. **Agency Commission:** No agency commission on classifieds.

**Closing date:** Ads must be received by the 25th of the month, two months prior to publication. **Acceptance:** Publisher reserves the right to accept or reject classified advertisements at his discretion.

## BUSINESS OPPORTUNITIES WANTED

### WANTED

High quality gear manufacturer operation. Small to medium (25") gears. With or without product line. All inquiries held in strictest confidence. Principles only.

Box GM  
c/o Gear Technology  
P.O. Box 1426  
Elk Grove Village, IL 60007

## POSITION WANTED

### POSITION WANTED

Service Engineer/Consultant. Forty-eight years prior experience at Gould & Eberhardt as service engineer. Available for consulting regarding service and parts for Gould & Eberhardt machinery.

Send inquiries to:

Ed Jacobs  
#8 Beau Monde Drive  
North Hampton, NH 03862  
(603) 964-7178

## COMPUTER AIDS

### GEARS-SPLINES DESIGN AND TOOLING

- Custom gear design including non-standard pressure angles for more strength.
- Programs to enter tooling data into computer files and search for existing cutters to cut a new gear or spline.
- Gearing computer software for sale.
- Consulting services for gear and spline problems.

**VAN GERPEN-REECE ENGINEERING**  
1502 Grand Blvd.  
Cedar Falls, Iowa 50613  
(319) 266 4674

CIRCLE A-38 ON READER REPLY CARD

### WANTED TO BUY

Large precision gear company. Must have modern equipment. Interested in companies that are currently operating at low production. Replies confidential.

Box BT, c/o Gear Technology  
P.O. Box 1426, Elk Grove Village, IL 60007

### Portrait of the Great American Investor



She'll go wherever the story takes her. She invests her time in her work and her money in U.S. Savings Bonds. Bonds now pay competitive rates, like money market accounts. Find out more, call 1-800-US-BONDS.



Bonds held less than five years earn a lower rate.

A public service of this publication.

## GET OUT OF THE DARK.

Open your eyes and see just how many subjects are covered in the new edition of the Consumer Information Catalog. It's free just for the asking and so are nearly half of the 200 federal publications described inside. Booklets on subjects like financial and career planning; eating right, exercising, and staying healthy; housing and child care; federal benefit programs. Just about everything you would need to know. Write today. We'll send you the latest edition of the Consumer Information Catalog, which is updated and published quarterly. It'll be a great help, you'll see. Just write:

**Consumer Information Center**  
Dept. TD, Pueblo, Colorado 81009  
U.S. General Services Administration

Bring in new customers for your business by advertising in  
**GEAR TECHNOLOGY,**  
The Journal of Gear Manufacturing.  
**Call (312) 437-6604**

## CUTTING FLUID SELECTION . . .

(continued from page 43)

free, but most fluids can be handled safely given adequate safeguards.

One cannot simply pay lip service to the acceptability of a given lubricating fluid. Both labor and the general public are now demanding that industry operate in a responsible manner that protects the health of workers, the general public and the environment. Increasing public pressure prompted by major chemical accidents in Bhopal, India, and several similar, but less serious, accidents that occurred in West Virginia, has prompted the federal and state governments to enact a number of new laws aimed at eliminating or reducing risk of exposure to hazardous chemicals.

One such law is the new federal standard on Hazard Communication (29 CFR 1910.1200) that was established by the Department of Labor, Occupational Safety and Health Administration (OSHA). As of November 25, 1985, chemical manufacturers, importers and distributors are required to:

- a. Label containers of hazardous materials and to provide Material Safety Data Sheets (MSDS) to anyone purchasing these chemicals,
- b. Notify their employees of the hazardous materials in the workplace,
- c. Demand appropriate training as to the safe handling and use of these materials,
- d. Properly label all hazardous materials at the workplace,
- e. Properly label all products shipped from suppliers,
- f. File Material Safety Data Sheets (MSDS) that provide additional health and safety information on all hazardous materials in the workplace,
- g. Post employee rights under the act,
- h. Be in compliance with all requirements of the Standard as of May 25, 1986, as an employer in SIC Codes 20-39.

The new federal Standard on Hazard Communication has had a significant impact on all compounds containing petroleum derived base stocks because

OSHA has adopted the reports of several major research groups into the Standard.

The International Agency for Research on Cancer (IARC) has determined that some base oils are carcinogenic. An oil product which contains more than 0.1% of such a base oil will be required by OSHA to have a statement on the Material Safety Data Sheet that it contains a carcinogenic component, and that component must be identified. The product container must also be labeled with such information. The oils in question are primarily naphthenic oils that have not undergone severe hydrogenation or solvent extraction.

At the same time, OSHA also requires that any product that contains a component having a polynuclear aromatic (PNA) content greater than 0.1% to contain a statement to that effect on the MSDS, as substances that contain PNA are considered carcinogenic. Again, the product container must be labeled with such information.

Chlorine in the form of chlorinated paraffin is a widely used extreme pressure agent. Chlorinated paraffins have been tested, and OSHA requires that two types of these materials must indicate the presence of a carcinogen on both the drum label and the MSDS.

The concern over the carcinogenic nature of some base oils is justifiable from a health standpoint, as well as from the viewpoint of potential for adverse employee reaction and litigation. Users of all types of lubricating fluids are advised to be familiar with the Standard and come into compliance.

Most manufacturers of gears use a wide variety of lubricating fluids and various chemicals, but do not actually manufacture or import them for sale to others. Therefore, the May 25, 1986, date was the important cutoff for employers in SIC Codes 20-39, in that their Hazard Communications training program had to be in place by that date.

There is a good deal of confusion relating to the labeling of non-chemical products. The OSHA standard does not require manufacturers of non-chemical products to label or to supply Material Safety Data Sheets to customers. The Standard provides complete exclusion for four categories of items including articles. Gears are an example of an article. While

customers of those items may request Material Safety Data Sheets from their suppliers, it is not a legal requirement for the supplier to provide one. Ultimately, many suppliers of articles are providing Material Safety Data Sheets, but it really is not necessary.

The OSHA Hazard Communication requirement is a good one, and management should support the law to the fullest extent possible. There has to be a genuine commitment to increasing the health and safety of both labor and management. The compliance program must start from a base of respect for every individual employed by a company. No company has ever gotten into financial difficulty or in trouble with OSHA because it adhered to a strict set of ethical principles.

---

*Acknowledgement: Presented at the SME Gear Processing and Manufacturing Clinic, November 11-13, Schaumburg, IL.*

---

## TECHNICAL CALENDAR

(continued from page 4)

### CALL FOR PAPERS

#### ASME 5TH INTERNATIONAL POWER TRANSMISSION AND GEARING CONFERENCE

The sponsors are issuing a call for papers to be presented at this conference to be held in the fall of next year. The deadline for submissions is Sept. 30, 1987.

This conference will focus on such topics as gear efficiency, noise, dynamics, geometry and lubrication, chain and belt drives, bearings, shafting, clutches and brakes.

For more information contact Donald L. Borden, P. O. Box 502, Elm Grove, WI 53122 (414) 784-9363.

# FORMASTER

## GRINDING WHEEL PROFILER

**EASY TO INSTALL** — Because of its small size and weight, the **FORMASTER** does not require major machine modifications and can be installed on nearly any grinder. Installation can usually be accomplished in less than a day.

**EASY TO OPERATE** — Two axis design simplifies programming and operation. You can choose between four popular controls that feature menu and G-Code programming, graphic simulation, automatic corner rounding, automatic diamond thickness compensation, and more.

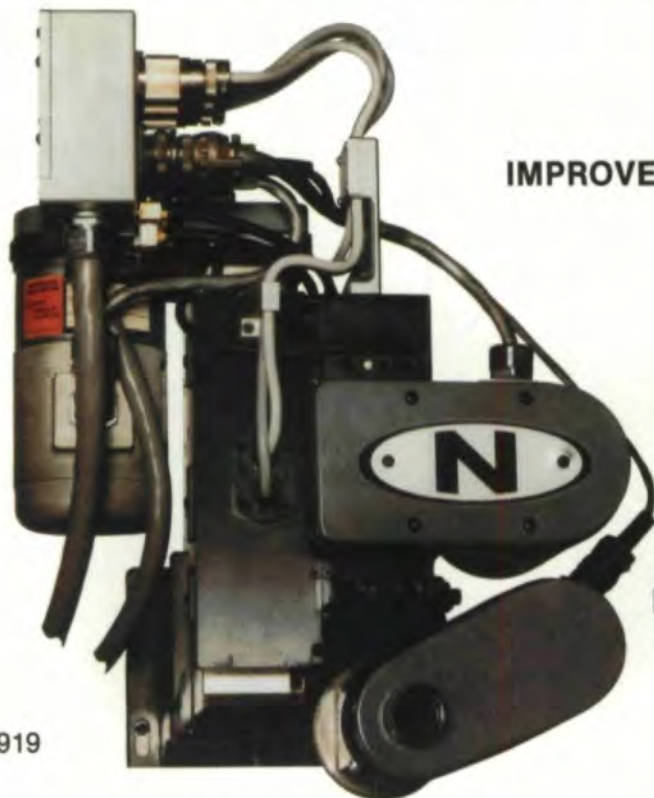

MADE IN U.S.A.

IMPROVES ACCURACY

REDUCES WHEEL DRESSING TIME

Patent No. 4,559,919

**ACCURATE** — To within  $\pm .0001$ " of programmed dimension, with repeat accuracy to within  $.00006$ ". Extra precision roller bearing ways, pre-loaded roller screws and optical linear encoders, as well as superior design and construction, give the **FORMASTER** the ability to hold inspection gage accuracy.

**PRODUCTIVE** — No templates or special diamond rolls are needed, so lead times and tooling inventories are reduced. Most forms can be programmed and dressed in, ready to grind in 30 to 45 minutes. Refreshing the form between grinding passes is accomplished in seconds.

**VERSATILE** — Can be used with single point diamonds or with optional rotary diamond wheel attachment. Nearly any form can be dressed quickly, easily and accurately.

**DURABLE** — Hard seals are closely fitted and are air purged to totally exclude contamination. Sealed servo motors, automatic lubrication and totally enclosed encoders minimize down time and ensure long service life.

P.O. Box 69  
Arden, NC 28704  
(704) 684-1002

# NORMAC

P.O. Box 207  
Northville, MI 48167  
(313) 349-2644

CIRCLE A-19 ON READER REPLY CARD

rapid changeover



# CNC

HOBBLING



systems compatible



floor to floor



auto-load

## **FORGET EVERYTHING YOU ALWAYS KNEW ABOUT PRODUCING GEARS**

The production of parallel-axis — spur and helical — gears has just undergone such a major change that most machinery in use today is obsolete.

Gleason CNC Systems compatible hobbing machines have written a whole new set of rules on how to produce spur and helical gears profitably. The Gleason CNC hobbers offer highest volume, highest degrees of flexibility and fastest changeover. What's more you can get automatic hob and fixture change plus automatic part load/unload.

That's why auto transmission plants throughout the world are equipped with Gleason hobbers. And that's why Gleason's production hobbing capability is rapidly becoming the world standard for gear production.

The real Gleason plus is the worldwide network of service and application engineering support that Gleason provides. The result consistently is this: maximum equipment reliability, maximum uptime and highest quality gear output.

Call now to learn more about the parallel-axis gear production of today — and tomorrow. The Gleason Works, 1000 University Avenue, Rochester, NY 14692. Detroit (313) 353-5205.

# **Gleason**

**The World of Gearing**

CIRCLE A-20 ON READER REPLY CARD