

Basic Honing & Advanced Free-Form Honing

Ned W. Wright & Herbert Schriefer

Rotary gear honing is a crossed-axis, fine, hard finishing process that uses pressure and abrasive honing tools to remove material along the tooth flanks in order to improve the surface finish (.1–.3 μm or 4–12 μ Ra), to remove nicks and burrs and to change or correct the tooth geometry. Ultimately, the end results are quieter, stronger and longer lasting gears.

The process is similar to shaving in that a crossed-axis setup is used to produce the sliding velocity necessary to remove stock. Shaving is a soft cutting process that uses a serrated tool to remove stock. Honing is a hard finishing process that removes stock by means of high pressure, sliding action and an abrasive honing stone. Oscillation of the workpiece along its axis can also be used during all or only during the final part of the cycle to facilitate metal removal and improve surface finish (Fig. 1).

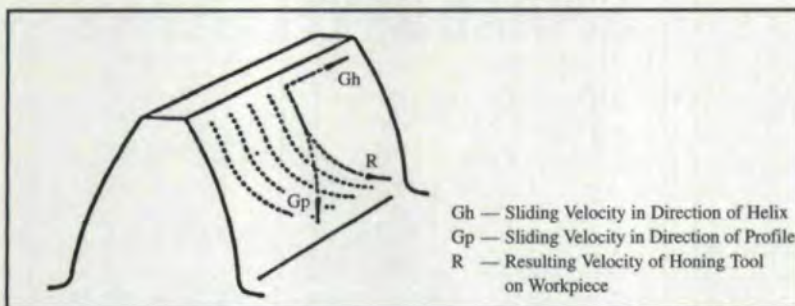

Fig. 1 — Kinematics of machining.

Table I — Technical Situation of Free-Form Honing (AGMA Quality Levels)

	Plunge Shaving	Free-Form Honing (Hob, Ht.tr & Hone)	Gear Grinding
Economical Stock Allowance/Flank	.0012"–.0016"	.0012"–.0024"	.004"–.006"
Usual Precut Gear Quality Grade	Q7–Q8	Q7–Q9	Q6–Q7
Reachable Quality Grade After Finishing	General: Q8–Q9 Accum. Pitch: Q7–Q8	General: Q10–Q11 Accum. Pitch: Q9–Q10	General: Q11–Q13 Accum. Pitch: Q10–Q12
Average Machining Time	25–35 sec.	35–70 sec.	120–240 sec.
Average Investment With Loader System	\$0.5 million	\$0.7 million	\$1.0 million
Factor of the Cost Relationship Per Workpiece	1	2	4

Rotary gear honing was developed to remove nicks and burrs in a timely and 100% efficient manner. Before the development of honing, most gears had to be sound tested and deburred manually or by a pencil type end mill. Obviously these were not sure-fire methods, and costly tear-downs would result later if gears with nicks and burrs were discovered in the assembly. However, over time, honing has proved to be not only an effective nick and burr removal system, but also effective for noise reduction and tooth geometry correction. Honing removes stock from the tooth flanks and thus improves runout, lead and profile characteristics. Honing, like shaving, will not dramatically improve the accumulated pitch error level of a gear. This is because the process is a radial pressure setup, and no guidance between the gear and tool is involved.

The honing tool is an internal gear made of either molded ceramic, molded vitrified material or plated with grit of varying quality levels and size. Ceramic tools are required for their stiffness characteristics and are normally used in higher pressure and larger stock removal applications. The tools average about 15" in pitch diameter and 1.58" wide. Grits can range from 50–60 size for coarse roughing to 400–500 grit for the fine polishing work required for aerospace gears. Most honing tools are in the 120–180 grit range.

The honing tool is first molded, and then the helical tooth tool is introduced by means of an internal grinder. Finally it is refined by rolling with a diamond dressing gear. Dressing takes place not only before the first piece is honed, but also after the honing tool exhibits wear and has lost some of its initial geometry. The number of pieces worked before this happens can vary greatly, but it is not unusual to redress every 50–100 pieces for ground gears, 30–50 for shaved gears and 20–40 for hobbled-only gears.

The Dressing Process

First the tip diameter or internal diameter of the honing tool is dressed by the diamond dressing ring. The honing tool usually operates between 500 and 1000 rpm. The dressing roller is a plain cylinder plated with diamond crystals.

Next, the flanks of the gear teeth are dressed by means of the diamond dressing tool/gear. The amount of stock removed during tooth flank dressing is approximately .002" in radial in-feed. The average honing tool can accommodate 5,000-30,000 parts during its usable life.

Normally the movements of the dressing cycle are not the same as for the honing cycle. Usually the diamond dressing tool/gear is identical to the desired geometry of the workpiece after honing. The "free form" or spheric honing process discussed later allows the end user to impart different tooth forms (i.e.; taper, crowning, bias) through machine motions, thus freeing the tool from the limitations of the desired end geometry.

Standard quality for the diamond dressing tool/gear is approximately AGMA 13. AGMA 14 indicates extra quality.

The Honing Process

The honing process uses honing oil applied with high pressure to clean the stone. Honing oil for gearing applications is normally low in viscosity and lubricity. This is necessary so that honing tools with minimum open grain structure can achieve enough abrasive resistance for efficient metal removal. The oil is primarily used just to clean the stone.

Unlike grinding, honing does not increase the tooth surface temperature, produce heat cracks or burn spots or reduce the tooth flank hardness. It also does not cold work or alter the microstructure of the gear material, nor does it generate internal stresses. In fact, the honing process improves the surface characteristics by imparting compressive stresses and refining the surface finish so that higher loads can be carried, since the oil film is not pierced by the more jagged tooth surfaces that result from shaving or grinding. The honing process also creates a more random tooth surface than either shaving or grinding, which imparts desirable noise characteristics through a white noise effect (Fig. 2).

When tohone

Rotary gear honing can be employed for the following applications: after hobbing and heat treatment; after hobbing, shaving and heat treatment; and after heat treatment and grinding.

Honing is now gaining acceptance as a hard finishing method used directly after hobbing and heat treatment. This is possible because of better quality hobs and hobbing machines which allow more accurate control of stock amount and flank scallop depth. The current trend in honing technology is also toward stiffer machine tools and honing tools and improved abrasive technology, all of which allow higher metal removal rates.

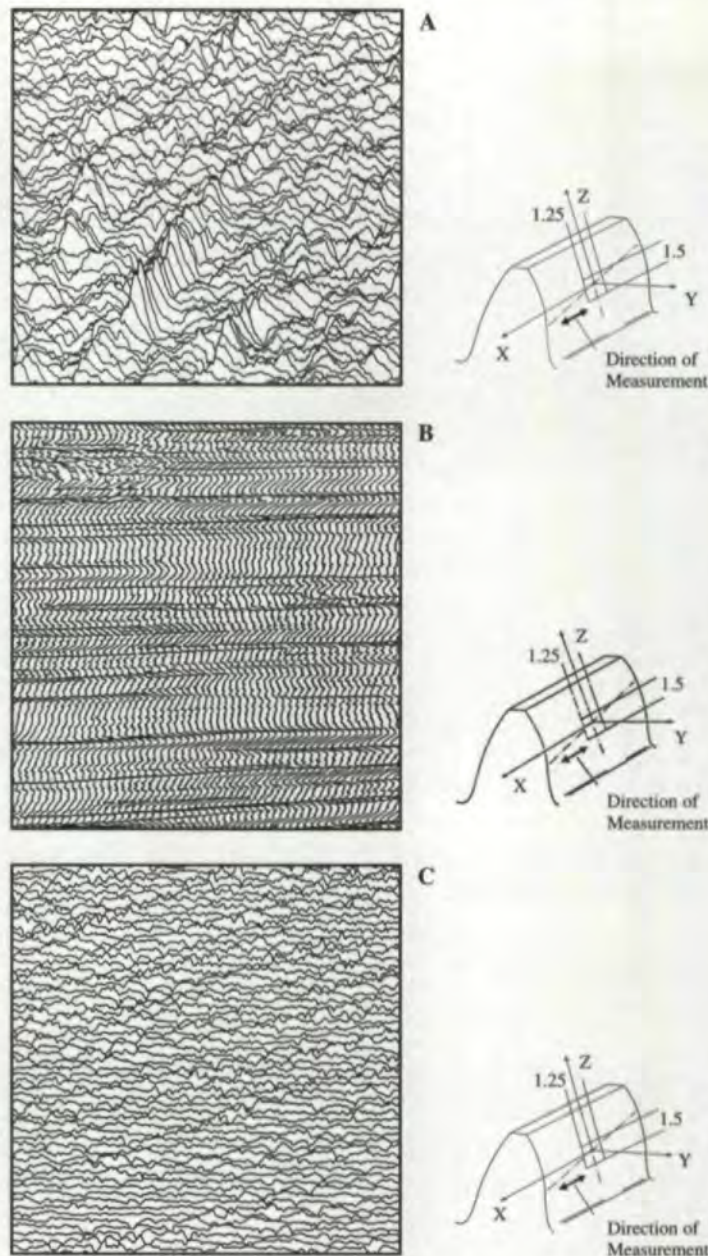

Fig. 2 — A) Surface structure of a shaved flank. B) Surface structure of a ground flank. C) Surface structure of a honed flank.

This technology allows honing to be a direct "after hobbing and heat treatment" operation.

While honing is still employed primarily after shaving and heat treatment or grinding, it has been used successfully to eliminate shaving in gears where the final desired part quality is in the AGMA 10, 11 and, in some cases, to AGMA 12 range (Table I). The honing process operates best where flank scallops are in the .0005"-.0007" range, thus allowing rapid stock removal and quality improvement and making it ideal for "after hob" situations. The honing process requires decent quality (AGMA 8-9) hardened parts in order to be efficient. This cannot be overstated. The free-form honing process is primarily suited for use on "after hobbled and hardened" gears.

Ned W. Wright

is a senior bevel/cylindrical gear applications engineer with The Gleason Works, Rochester, NY. He has been with Gleason for more than 15 years and is responsible for gear design and development and customer development and training.

Herbert Schriefer

is the Director of Engineering and Research & Development at Gleason-HURTH, Munich, Germany. He has a doctorate in gear theory from the University of Aachen.

The Advantages of Internal Honing

Internal honing has several advantages over external honing of external gears. The primary benefits are the higher contact surfaces offered by rolling a given gear with an internal gear. These higher contact surfaces provide better equilibrium of the internal contact forces, and this enhances the ability to correct profile errors on smaller diameter gears where fluctuating dynamic forces are a constant problem.

It is not unusual for the honing process to improve an after-hob or after-shave part by two quality grades. An after-grind gear set is less improved—perhaps one class at most. The biggest benefit of honing ground gears, besides noise improvement, is its ability to reduce break-in time and increase load carrying capacities by as much as 30% and wear life by as much as 1,000%.

Before and After Results of Spheric Honing

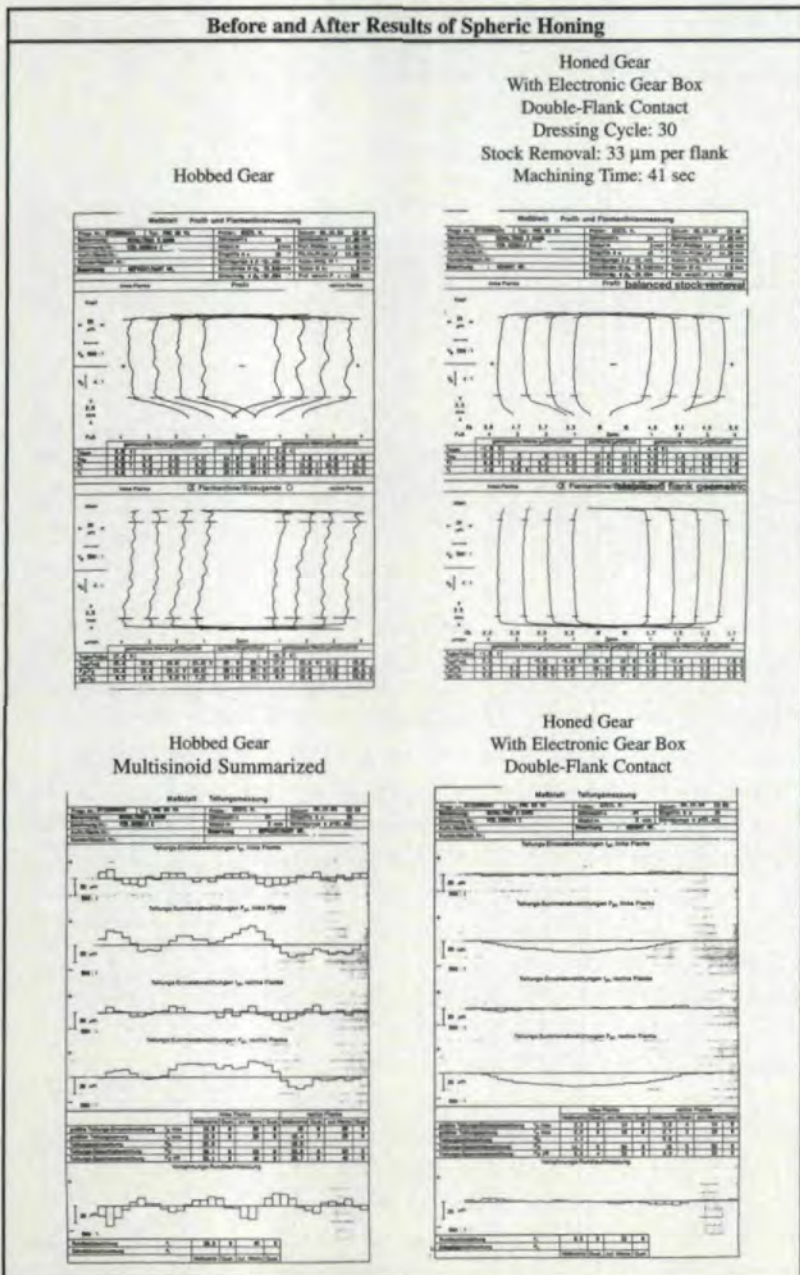

Most internal type honing machines have a 4.0" wide honing tool capacity. This means that while most honing tools are 1.5" wide, there is still room for a second or possibly third tool. The two tools can be employed as roughing or finishing tools on the same gear section or as two independent tools to be used to hone two distinct gear sections, such as those found on a shaft. The face width of the gear must normally be under 1.25" for cluster honing.

Virtually all of the modern CNC honing machines are of the internal style for use on external gears. This means that the honing tool is actually an internal gear/annulus with either the workpiece or the diamond dressing tool running inside it as the mating member.

The internal style still has limitations, and one of these is honing small diameter gears (1.5" dia. and less) or very large diameter gears, where rolling interference can occur with the honing tool.

CNC Honing

Most honing machines have two linear and one swivel axes. The free form or spheric honing process has three orthogonal kinematic CNC axes. This third axis allows the contact point to be maintained in the center of the tool even if the tool is shifted, or it can create special kinematic effects.

CNC honing offers extensive benefits in addition to fast setup times. These benefits include automatic calculation of new machine axes positions to maintain size after diamond dressing, and calculation of a new, increased crossed-axis angle setting to maintain constant pressure and force distribution between the teeth of the workpiece and the tool during the entire life of the tool.

Some CNC honing machines operate in both rotational directions to balance the tool wear, stock removal and profile errors. However, CNC honing machines that use Electronic Gearboxes (EGBs) typically rotate in only one direction, and the acceleration rates are adjusted, depending on the torque amount measured. Typically free-form honing is done on EGB machines.

A Typical Honing Cycle

A typical honing cycle on a CNC machine with an EGB is as follows:

- The wheel and gear begin rotating.
- An electronic stock divider does rough stock division—accuracy .002".
- The honing tool makes rapid traverse to work.
- The gear is stock-divided to the tool through force measurements using an EGB.
- The honing cycle starts with the EGB engaged to make pitch improvements.

- Modifications to the tooth roughness are then made without the EGB.

The following cycles are also found in older honing machines:

- *Loose backlash.* Here the honing tool and work are in loose mesh. This is used primarily for slight improvement in surface and normally employed on fine pitch or already ground gears.

- *Zero backlash.* The honing tool and workpiece are in tight mesh at fixed center distance, providing maximum runout improvement with minimum stock removal.

- *Constant pressure.* The honing tool and workpiece are in mesh at a constant pressure. This method removes nicks and burrs and provides surface finish improvement in minimum time.

Spheric Honing

The automobile industry has long demanded the development of a hard finishing process that is comparable in quality and cost to free shaving unhardened gears. Some attempts at developing such a process were made using CBN coated or ceramic bonded external toothed tools. The basic problem was to maintain tooth quality with this hard fine machining process even though the initial quality parameters were much worse than with green shaving, where distortion caused by hardening added another difficult process. As a rule, the requirement was to raise the pre-cut quality of the teeth, a demand which could not be met.

Meanwhile, various investigations showed that the known capabilities of internal toothed honing tools could be expanded considerably by using different types of kinematics and more powerful machinery, and the idea of applying this expanded capability to the hard finishing process was born. Free-form (spheric) honing with torque-controlled, two-flank action or with electronic guidance was developed.

The word "spheric" refers to the spherical path of the tool relative to the workpiece. It is a kinematic extension of the relative movements—parallel, tangential, diagonal and plunge—familiar to green shaving.

The use of the term "honing" is debatable when referring to the machining of pre-cut teeth with large machining allowances on the flanks and when considering the standard characteristics of the various honing processes.

However, in this case, "honed" refers to the quality of specific properties of surfaces, which is higher than that of the same properties in ground gears. Since the final surface of the tooth flanks machined using the free-form (spheric honing) process has the excellent roughness and undula-

tion characteristics of a honed surface, this process should be distinguished from the other hard finishing methods; therefore, "gear honing" has been used for several decades to refer to gear manufacturing processes which achieve a surface quality better than a ground surface.

The technical difficulties characteristic of gear honing in the past can now be largely avoided using spheric honing because it is sufficiently precise mathematically and technologically. Spheric honing of pre-cut and hardened toothed workpieces represents a new technology that in most respects fills the niche in gear finishing between green shaving and heat treatment and grinding.

As shown in Table I, spheric honing combines the positive features of gear grinding and green shaving. Therefore, this process can be technologically, qualitatively and economically classified between these technologies.

The positive features of gear grinding are

- Precut, hardened workpieces can be processed,
- Precutting quality does not affect final quality, with the possible exception of runout,
- High quality tooth system production,
- Good flexibility in terms of flank modification,
- Low input for adaptations to different workpieces,
- Process can be precisely specified.

The positive features of green shaving are

- Economy,
- Simple machine and reliable peripherals do not require a highly skilled operator,
- Highly suitable for mass production,
- Low noise modifications and flank surface structures for tooth systems,
- Straightforward tool setup and logistics.

Free-form honing can provide some of these features while offering more of the features of grinding and green shaving in others.

Free Form Kinematics

Fig. 3 shows the kinematics of free form honing. The barrel-shaped part of the surface of the workpiece rotates about axis III, and the barrel-shaped part of the surface of the internal toothed tool about axis II. The two pitch surfaces have a tangential contact at point IV. The oscillating sphere for the workpiece pitch surface has its center at I, and the oscillating sphere for the pitch surface of the hollow tool at V. If the rotating partial surface of the workpiece is moved forward on its spherical envelope, which is rotating with it, with the forward feed being specified at will, the pitch surface of the workpiece will be enveloped

Advantages of the Electronic Gear Box Drive System

- Exact dressing of the preshaped honing tool.
- Dressing of wide ranges of the tool diameter with definitely guided spheric motions.
- Improvement of the accumulated pitch deviations up to halving the amplitudes.
- Variations in the technology caused by free running, torque or electronic guided engagement.
- Adaptive control of stock allowance with automatic machining time regulation.
- Balanced stock removal between right and left hand flanks.
- Adaptive control of accumulated pitch deviations with automatic machining time regulation.

by tangential point IV. The pitch body of the hollow tool can also be moved on its oscillating sphere at a specified forward feed, and the tangential point IV will also envelop the pitch body of the hollow.

A straight line g goes through I, intersects II, intersects III, is colinear with the pitch and envelope body normals at IV and goes through V. It describes the regularity with which any crowning or taper of the workpiece helix traces can be produced with the orthogonal feed axes $V_x-V_y-V_z$, using specific assigned points on the pitch surface of the tool. Here no account is taken initially of the fact that defined helix angles are to be generated on the pitch surface of the workpiece, where the condition is that the helix traces of the tool must be in contact with the helix lines of the workpiece at point IV. It is possible to influence the tangential contact of the helix traces by a small relative rotation about line g without harming the tangential conditions of the pitch surfaces at IV. For the sake of simplicity, the crossing axes angle movement V_A is used for this rotation, though compensation has to be made for the loss of intersection point II through $V_x-V_y-V_z$. The calculation for these kinematic relationships is made automatically in the controller of the machine, starting from the screen-controlled operating panel.

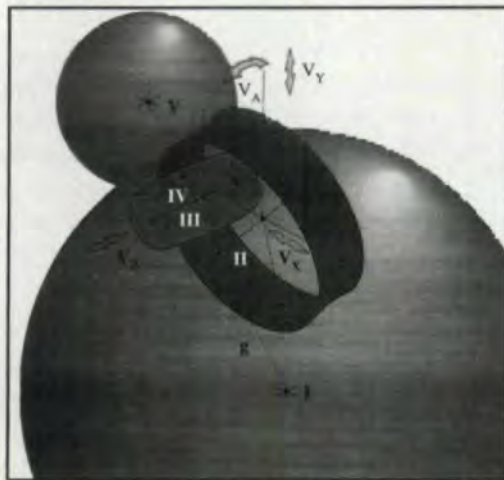

Fig. 3 — Basic kinematics of the spheric honing process.

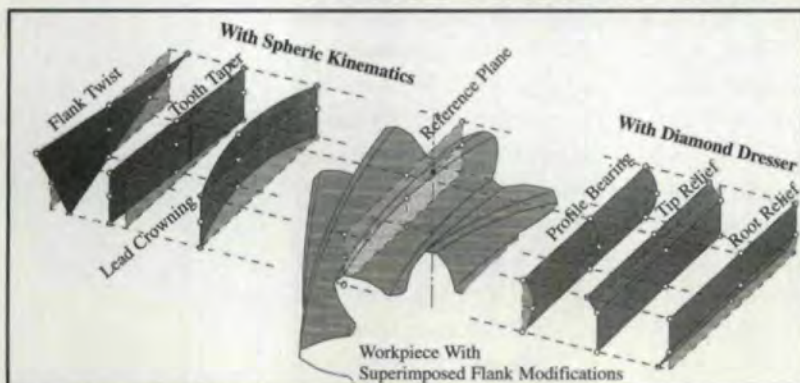

Fig. 4 — Flank modifications with spheric honing.

The advantage of the spheric honing technique, particularly in two-flank contact, is that the contact conditions between the left and right flanks are controllable at every point of contact. This is particularly important if there is flank contact outside the axial intersection when using side tools. Furthermore, the helix trace modification for the dressing wheel does not have to correspond with that of the workpiece, and forward feed strategies can be fluidly transformed into each other. So it is possible to work with a very fast plunge at the start of the cycle, which shortly before reaching the required axial distance, changes without stopping to a spherical feed with which the optional helix trace modification is produced.

Spheric honing can also produce positive and negative twisted flanks (bias) with constant initial conditions for the diamond dresser and the tool. This means that the positive (but also negative) twisted flanks, which are beneficial in noise reduction, can be produced in a simple manner. Negative twist of the flank is important if the mating gear has very large effective twist because it has been manufactured with a negative twist.

Because of the ability to freely configure the system kinematics, spheric honing can mimic all the honing processes currently known, and furthermore, unlike the kinematics of conventional processes, it has the ability to provide spatial feed strategies that are particularly suitable about the equilibrium of forces with meshing teeth (Fig. 4).

The feed strategies can be completely different for dressing with a diamond dresser than when machining the workpieces, allowing the different force conditions applicable when dressing and machining to be appropriately addressed. This is very important when the geometry of the tool flanks has to be changed by increasing internal tool diameter for dressing to make optimum use of the diameter. The equilibrium of forces between left and right flank contact has to be maintained, which is achieved by changing the contact conditions. This task is particularly difficult if the width of the diamond dresser is smaller than that of the honing wheel since, if the helix angle of the honing wheel changes, a relative helical rotation of the tool is necessary. However, the electronic gearbox and the free-form, spheric honing method support these technological requirements in an ideal manner. The machine incorporates a program that simulates all the process conditions and ensures as far as possible that the optimum conditions are provided. With this method, it is possible to increase the number of pieces per tool by

a factor of up to 5 compared with conventional methods.

The kinematic axes V_x - V_y - V_z in Fig. 3 are identified with the corresponding machine axes in Fig. 5. Note that the usual swivel table axis for producing the lead modification is not present, since the modification is produced by the simultaneous spheric interpolation of V_x - V_y - V_z and, if necessary, with V_A . The axis V_z is also the loading axis, since the workpiece is taken by the spindle head, moved out to the left and brought into engagement using V_z , while at the same time, the head stock will move into the center of the clamping system.

The axes C_1 and C_2 in Fig. 5 are both driven by water-cooled motors, meaning that they can be controlled either by torque or electronically. The electronically controlled device is advantageous when there are very unfavorable meshing conditions present. Torque control would follow the modulations caused by rotation.

The spheric honing process requires a machine to be fitted with an electronic gearbox as standard, though this can be operated and used in various modes.

The electronic gearbox operation is infinitely variable. This means that the positive drive effect can be varied from inactive to fully active. This enables the operating modes of free running, torque action and positive action to be used. It has often proven beneficial to carry out the initial dressing with full positive action to produce a tool condition of defined quality; then to carry out a few dressing passes with torque action; and then to make a positive action pass again at specified dressing intervals. In this way, the dressing times should be shortened, and tool life will be extended. Furthermore, certain workpieces (e.g. very well ground pieces) are more suited to free running machining than to positive action machining. If workpiece preparation is good and the required quality permits it, torque action machining is more economical than positive action operation. The electronic gearbox, thus, has the capacity to adapt optimally to a variety of technological demands.

The electronic gearbox is also used for the operations of adaptive centering of workpiece flanks, adaptive allowance capability and adaptive cumulative pitch capability.

- Adaptive centering ensures that the metal removal rate is approximately equal from the right and left flanks of the workpiece.

- The adaptive allowance strategy ensures detection of the initial honing wheel/workpiece contact and that the necessary machining time is set.

- The adaptive cumulative pitch strategy ensures that cumulative pitch characteristics are evaluated and that the necessary machining time is set.

These measures substantially increase the reliability of the process, since the honing tools only have a limited metal removal capacity, and overloading of the tool results immediately in geometric changes and reduced tool life.

The axes V_z - V_y have a compound slide function which moves the tool along its own axis relative to the workpiece. This makes it possible to carry out rough finish machining or to achieve longer tool life using several tools next to each other, or to machine several different tooth forms in one loading. By using suitable control data related to the workpiece, this function can also be moved automatically to the intersection point of the axes without the need to move the tailstock or spindle head manually.

The compound slide method can also be advantageously used if a repeat series of workpieces that are equally clampable, but have different flank geometries, have to be machined. Different simultaneously mounted honing tools, different diamond dressers and one dressing roller for dressing the inner diameter of the internal gear wheel are then used. This process can be designed such that the control system automatically identifies the workpiece so that, in principle, mixed production can be carried out.

Shifting the tool by moving the Y-Z compound slide amounts to the same as shifting the tool along the axis. This shifting is very important in kinematic terms, since the meshing conditions consequently remain unaffected. The tool is

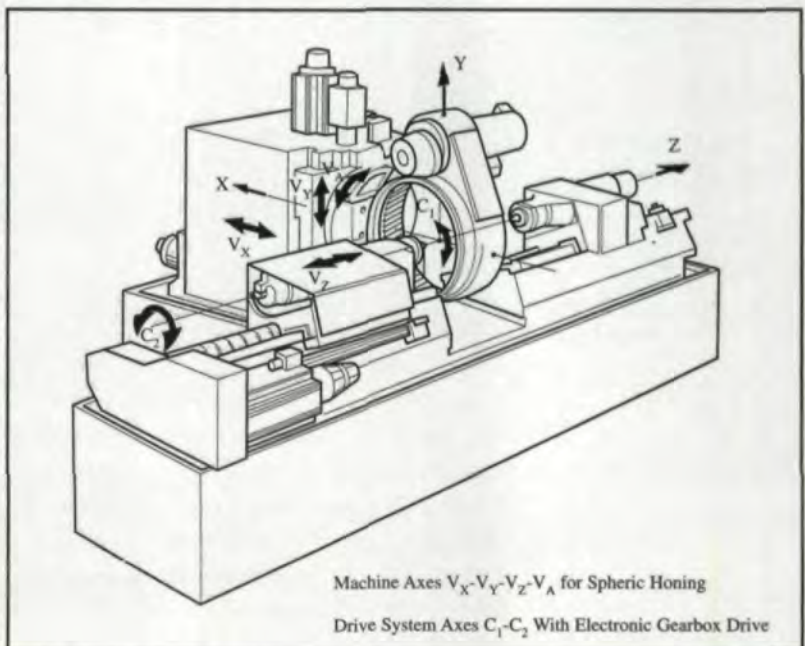

Fig. 5—Machine and drive system axes for spheric honing with an electronic gearbox drive.

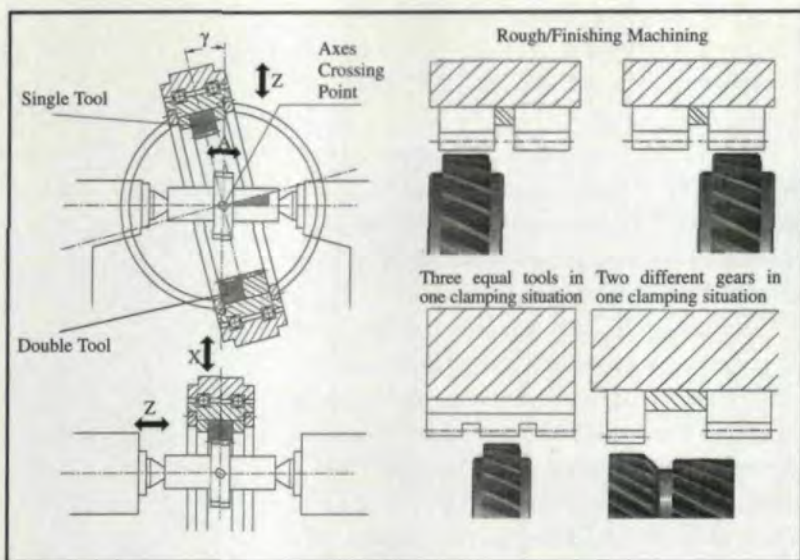

Fig. 6 — Advantages of the compound slide technique.

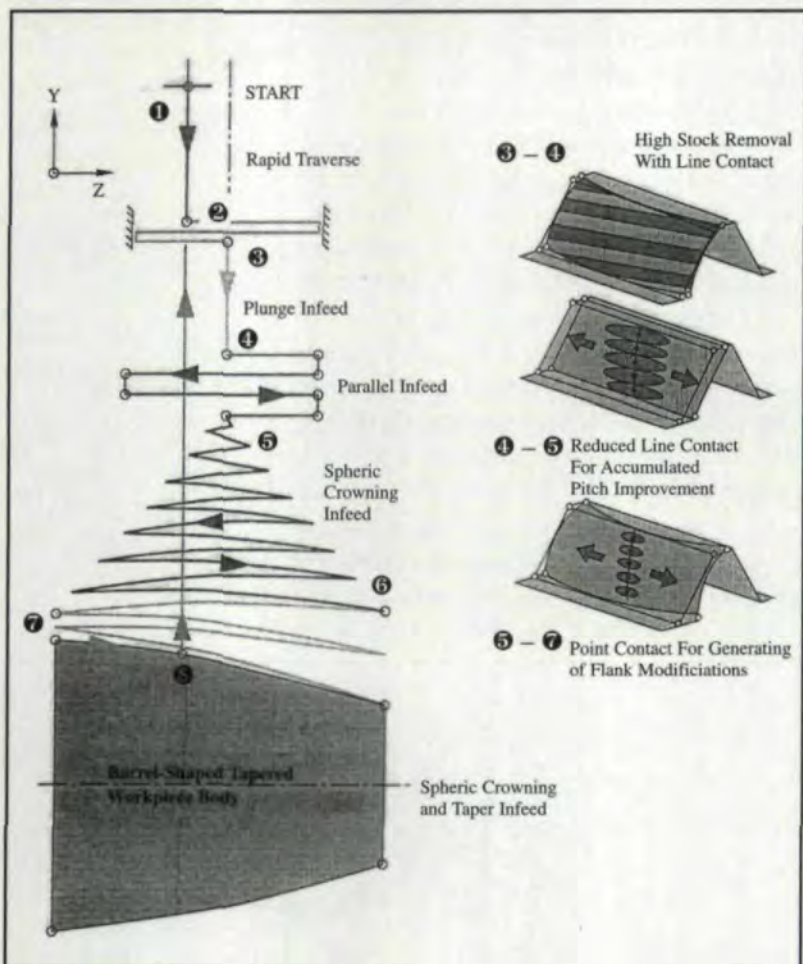

Fig. 7 — Tooth contact behavior between tool and workpiece.

always in the same position in spatial kinematic terms relative to the workpiece. If the tool is displaced only along the V_z axis, the tool/workpiece contact is shifted into the tool's hyperbolic edge zones. This should be avoided to maintain the simplicity of the process (Fig. 6).

The tooth contact between the honing wheel flanks and the workpiece is very important in achieving good geometric and economic results. Double flank contact is always used. This results

in contact forces that are very high because of the limited cutting capacity as a consequence of the relatively low effective cutting speeds balancing each other out within the meshing teeth. The electronic gearbox action has no effect on these internal contact forces, since the frequency of the contact force fluctuations can be on the order of several kilohertz and, thus, a counter oscillation of the same high frequency by the drive system would be necessary to compensate for the force fluctuations. Therefore, the rigidity of the contact between the right and left flank should be designed such that an approximate equilibrium of forces exists in every meshing position. In this regard, the possibilities offered by the kinematics of spheric honing play a substantial role, as does the sizing of the geometric parameters of the honing tool and the diamond dresser (Fig. 7).

The feed strategies can be specified completely freely with spheric honing (Fig. 8). Advantageous feed strategies for certain tasks have emerged, and these have been included as standard programs in the process.

The structure of the surface is responsible for the surface noise quality of a flank. Fig. 2a shows the diffuse surface structure of a shaved hardened flank with an R_a value of 0.4 microns ($16\mu'' R_a$). Since no orientation of a periodic undulation in or near the direction of the line of contact to the gear and its mating gear in the transmission exists, no periodic surface noise will be audible.

Fig. 2b shows the surface structure of a ground flank with an R_a value of 0.3 microns ($12\mu'' R_a$). A distinct micro-undulation pattern can be seen near the line of contact, and this is symptomatic of the typical metallic noise characteristics of ground flanks. Normally an R_a value of 0.3 microns would suffice to avoid metal-to-metal contact due to the formation of a hydrodynamic oil film. With this type of undulating structure, either microvibrations break down the oil film or they interfere with the film's formation.

Fig. 2c shows the surface structure of a spheric honed flank with an R_a value of 0.2 microns ($8\mu'' R_a$). The orientation of the structure runs in the direction of the vector of the honing sliding velocity on the flanks. This structure, however, has a low roughness, so that the effect is the same as for a diffuse surface. Micro-undulations on the flanks are avoided due to the large contact areas and the tip-to-root orientation of the path of contact during honing, and this has a very beneficial effect on the noise characteristics.

When examining the tooth contact properties, consideration must be given as to how many teeth of the tool and workpiece are simultaneous-

ly in mesh. The fact that double-flank contact is being used, the relationship between the type of flank contact and the tooth height and width, and the flank microcontact all must be considered. These correlations highlight the intricate and complex nature of honing and the fact that only a process which is versatile in adapting to these conditions has any chance of success.

Conclusion

The test charts on page 28 show results after precutting and heat treatment and after spheric honing. In all the machining carried out so far, spheric honing could meet the target of achieving the same quality as green shaving before heat treatment. With torque-controlled spheric honing, at least the same strengths and weaknesses which are characteristic of green shaving show up:

- Good form stability of the flanks, but with a tendency to deviations due to wobble, depending on the pre-machining of the teeth and the clamping conditions.
- Good results for individual pitch deviations, concentricity and lead, but less control of the cumulative pitch deviations.

If all flanks with all deviations are considered generally, there is a systematic collective deviation caused by the process. In the assembled state with the mating gear, however, this acts like a random collective deviation which permanently suppresses narrow banded resonant excitation. With the characteristics of the surface, this effect is largely responsible for the quiet running of green shaved or honed gears.

The machining quality grades after hobbing, hardening, bore grinding and surface grinding for the car industries are listed in Table II. ○

References:

1. Dugas, John. "Rotary Gear Honing," The 16th annual AGMA Gear Symposium, April 10-12, 1988.
2. Wunderlin, Willy. "Hard Finishing of Gear Tooth Flanks by Means of the Honing Process," Third World Congress on Gearing, February 12-14, 1992.
3. Schriefer, Herbert. "Spheric Honing," Hurth, 1995.

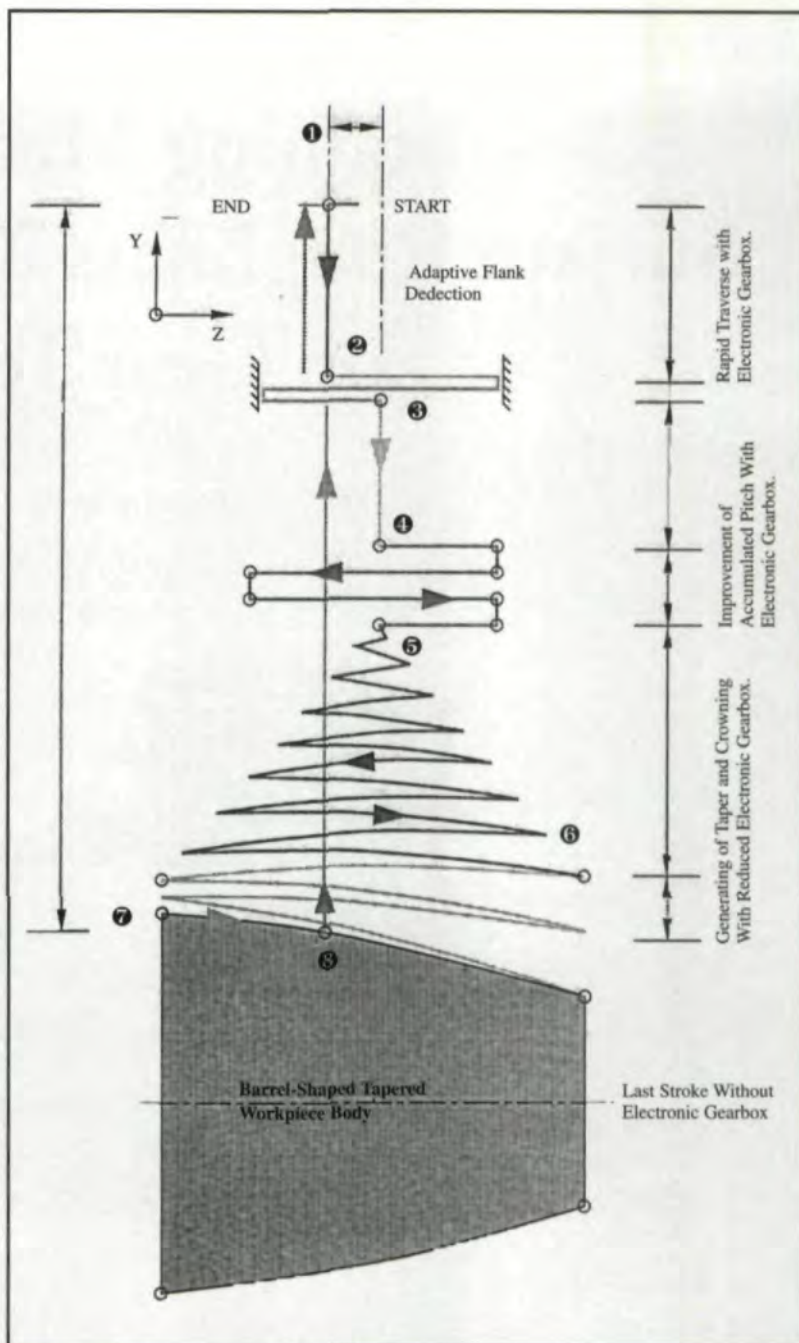

Fig. 8 — Spheric honing infeed strategies.

Table II — Quality Grades Before and After Spheric Honing

Criterion (DIN Symbols)	After Hobbing and Hardening AGMA Tol./Class	After Honing AGMA Grade Tol./Class
1. Pressure angle deviation $f_{H\alpha}$	(+/- .0007")	(+/- .00035")
2. Profile form deviation f_{fa}	(.0008"-9") 8	(.0004") 10
3. Lead deviation $f_{H\beta}$	(+/- .0007")	(+/- .0005")
4. Lead form deviation f_{β}	(.0006") 8-9	(.00035") 10
5. Adjacent Pitch Deviation f_u	(.0007")	(.0005")
6. Accumulated pitch deviation F_p	(.0022") 8-9	(.0016") 9-10
7. Pitch Variation f_p	(.0005-6") 9	(.0004") 10
8. Runout F_r	(.0022") 8	(.0016") 10

(Deviation figure for workpiece in thousandths of an inch, NDP = 12.7 to 7.3, diameter 2.0" to 5.0", face width up to 1.60", utilization of tolerance 100%).

Tell Us What You Think . . .

If you found this article of interest and/or useful, please circle 203.

For more information about Gleason Corporation, circle 204.