

PentacMono-RT: High-Performance Face Milling Cutter Heads

Dr. Hermann J. Stadtfeld

Past and Present Cutter Systems

Bevel and hypoid gears can be cut in a single indexing process (face milling) or in a continuous indexing process (face hobbing); both use cutter heads with a certain number of slot groups (equal blade groups) (Fig. 1). Each blade group consists of one to three blades assembled in the respective cutter head slots. In the case of three-blades-per-blade group, a rougher or bottom blade in each blade group roughs the convex and concave flank surfaces, as well as the root fillets and bottoms of a bevel gear. The second blade of each blade group is commonly an outside blade that finish-cuts the concave flank surfaces and the concave side root fillets. The third blade in each blade group is commonly an inside blade that finish-cuts the convex flank surfaces and the convex side root fillets,

A more common arrangement is the cutter head in Figure 1 with two-slots-per-blade group. The first blade of each blade group is an outside blade. The outside blades are tasked with roughing and finishing the concave flanks and the concave side of the root fillets, including a part of the root bottom of all slots on a bevel gear. The second blade of each blade group is an inside blade. The inside blades rough and finish the convex flanks and the convex side of the root fillets, including a part of the root bottom of all slots on a bevel gear. Figure 2 shows the chip removal arrangement where the outside blade removes a chip on the concave flank with a sharp side of the blade; the dull side of the blade has no cutting contact. The following inside blade removes a chip on the convex flank with the sharp side of the blade; here also the dull side of the blade has no cutting contact.

Another possibility is a cutter head with a single-blade-per-blade group. In such an arrangement the single-blade-type (full profile blade) will perform the roughing and finishing of the concave flanks, the concave root fillets, the root bottoms, the convex root fillets and the

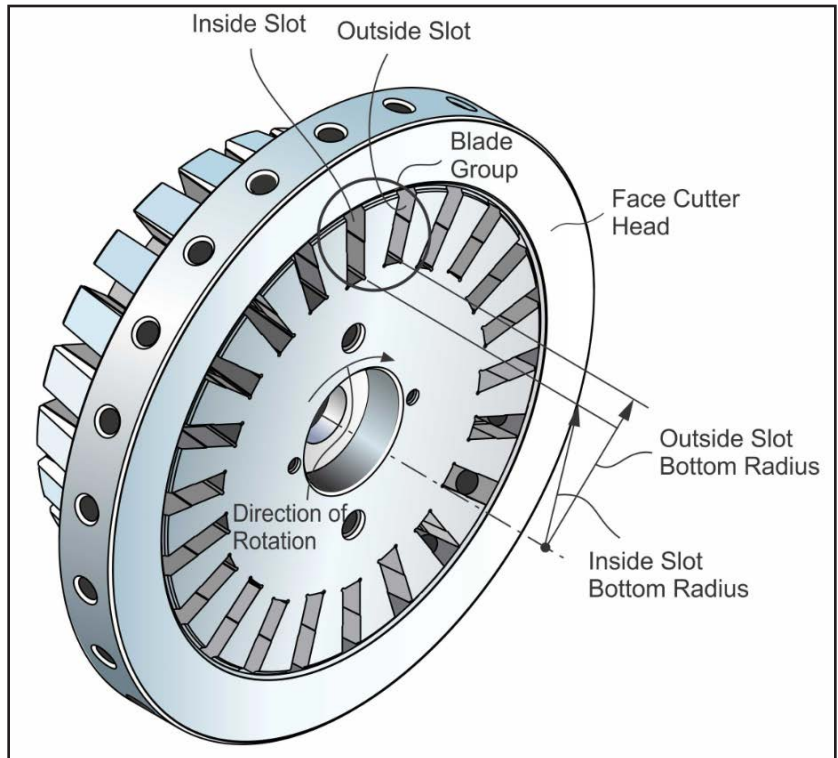

Figure 1 Face milling cutter head with rectangular blade slots (Ref. 1).

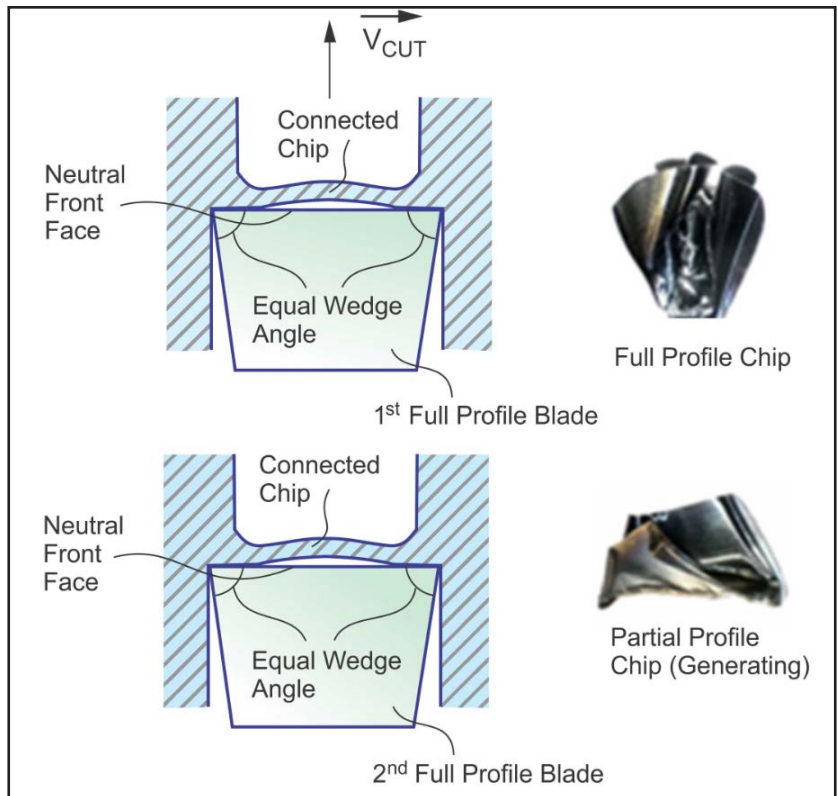

Figure 2 Outside blade and inside blade in cutting contact.

convex flanks of a bevel gear.

The single-blade-type cutter heads with full profile blades are only applied to face milled bevel gears that are cut in a completing process; this is because completing bevel gears show a parallel tooth slot width along the root bottom between toe and heel. The schematically shown cutting process in Figure 3, which only uses one blade type in order to manufacture both flanks of each gear slot, including the slot bottoms, has a number of disadvantages. The blade front face that connects both cutting edges (and in general is a plane surface) can only provide side rake angles of about zero degree for both cutting edges. With a side rake angle of zero degree (front face perpendicular to relative cutting velocity) the chip removal process must conduct more plasticization work in order to remove chips (rather than shearing the chips off with a sharp cutting edge that requires a positive side rake angle). Due to the cutting action around the entire blade profile, the chips from the two flanks are often a connected single chip (Fig. 3). Both zero side rake angle as well as connected chips lead to higher cutting forces and higher part temperature during the cutting and subsequently leads to lower part quality. Another disadvantage is that the connected outside-inside chips require a large space and are therefore not easily flowing away from the cutting area. Large, bulky chips are more likely to pack between consecutive blades, unlike smaller rolled chips like those produced with the outside-inside blade cutting system in Figure 2 that has a two-blades blade group.

The blade in Figure 4 used in the “single-blade-per-blade-group cutter head” comprises an outside cutting edge with an edge radius, an inside cutting edge with an inside edge radius, and a top width that spaces the two cutting edges in order to cut the correct slot width.

Obstacles Resulting from Full Profile Chip Formation

The bulky and large chips (Fig. 3) require a wide space between two preceding blades. In modern, high-productive cutter heads, the space between blades is limited, which causes chip flow problems. Particularly in front of the outside blades, chip flow is constrained because

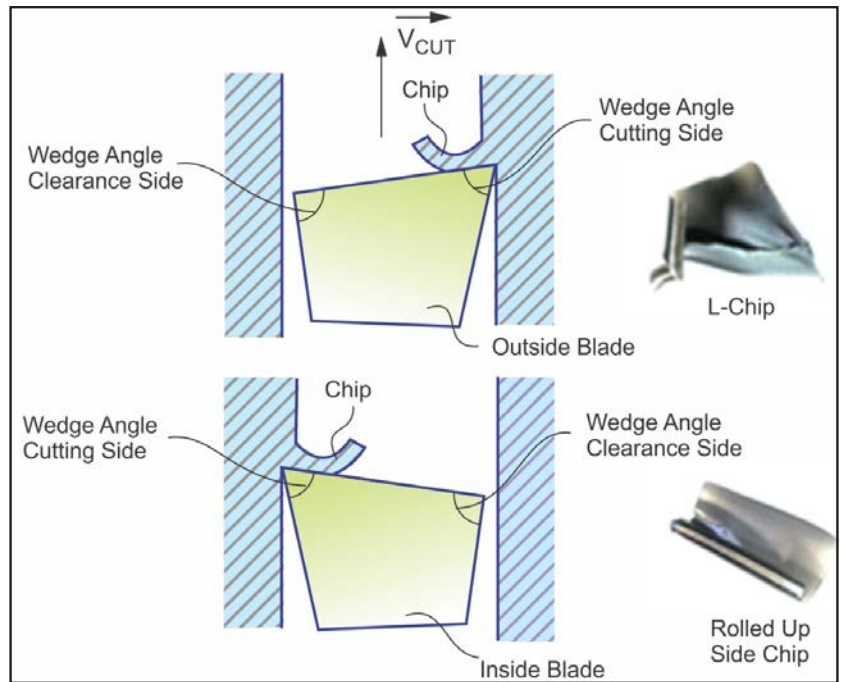

Figure 3 Chip removal action with two consecutive full profile blades.

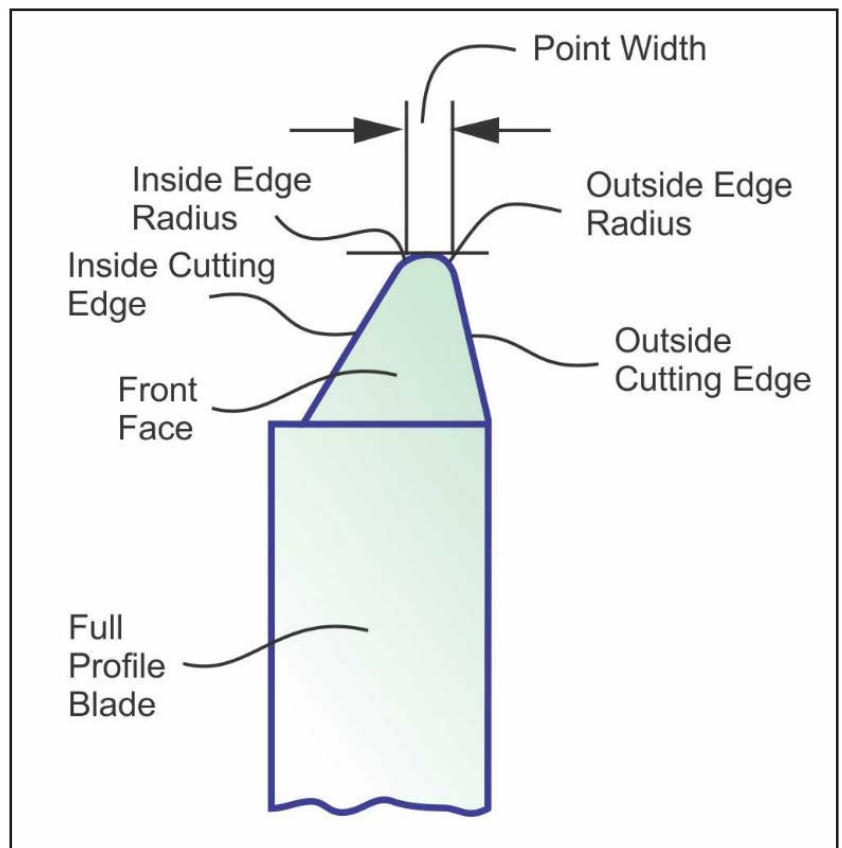

Figure 4 Full profile stick blade with outside and inside cutting edge.

the space is narrowing towards the outside of the cutter head. If the first chip is “caught” between two blades, then in the next revolution a new chip is developed in the same slot. Particularly when cutting Formate ring gears, the already-present chip and the newly cut chip cannot escape the gap between the blades because this gap is closed on both sides by the convex and the concave flank. Additional space is not available, which leads to a compression of both chips in order for both to fit in the given space. Each additional chip reduces the likelihood that the chips can leave the gap between the blades. Already the third and fourth chips can cause a situation like that shown in Figure 5.

Slight chip packing results in increased part temperature and reduced surface finish quality. If chip packing reaches the point shown in Figure 5, it will lead to a fatal end of the production because blades



Figure 5 Chip packing between two blades.

will break and the workholding—or even the machine—can be damaged.

Reducing the feed or roll rates, or eliminating every other blade from the cutter head will, in most cases, solve the tool failure. However, it will in turn reduce productivity and therefore increase the cost-per-manufactured-part.

Part temperature in a high-speed, dry cutting process might be viewed as a problem, although certain compensations or corrections are available to reduce, for example, temperature growth-inflicted flank geometry deviations.

The process parameters in *PowerCutting* are chosen and optimized in order to remove the largest amount of process heat with the chips away from the part, the cutting tool, and from the machine components. Because of this, the temperature increase of the manufactured parts reaches a quasi-steady-state level after cutting of 5 to 10 parts. It is called a quasi-steady-state because after reaching this point, there first will be a very slow but steady increase of the part temperature that can be recognized after every 10 to 20 parts. Towards the end of the tool life a more rapid temperature increase can be noted which, along with other criteria, is a sign of the point where the cutter head should be exchanged.

Figure 6 indicates the differences of the average part temperature of a representative automotive-size Formate ring gear. Along with the increase of part temperature in the case of increasing cutting surface speed, the graphic in Figure 6 also reflects that the two-face blade system using inside and outside blades generates the lowest part temperatures. The reason

is the 12° side rake angle that makes the blade appear very sharp, resulting in a high shearing component and a low cold forming component during chip formation.

The highest average part temperatures are recorded in the case of a cutter head with full profile blades. The amount of “cold forming” or plasticization work that generates heat is higher than for two-face blades because of the zero degree side rake angle and the fact that the bulky chip, which is formed by the entire profile of the blade, is restricted in its flow; the chips cannot roll like the side-chips or L-chips created by the two-face inside and outside blade system. The crumbling of the bulky full profile chip requires additional energy that is converted to heat, as is evident in the recorded part temperature.

The temperature graph for the three-face blade system with inside and outside blades is slightly above the two-face graph. The side rake angles of about 4.5° cause a higher material plasticization work than the 12° two-face blades, but the chip can freely roll as side-chips or L-chips. The amount of plasticization work the three-face blade system performs is a desirable effect because the steel appears softer while it is sheared off and creates a better surface finish compared to the two-face cut parts.

The more significant problem is the growing temperature around the circumference of a pinion or a gear (Fig. 7). The heat that a single-indexing process generates is located in the area of the currently cut slot. If the temperature of a fresh-cut bevel gear should be recorded, it is necessary to choose a certain tooth or slot for the temperature measurement. Immediately after the cutting is finished, the temperature between the first cut slot and the last cut slot might vary more than 80°. The reason is that the highest temperature moves with the cutting zone around the part. The zone of the first cut slot has had the most time to cool down when the cutting reaches the last slot (adjacent to the first slot). The jump in temperature shown in Figure 7 results in a so-called “first-to-last error” in the tooth spacing that is difficult to correct entirely with a spacing compensation. A steady increase of this temperature jump during the cutting of a complete batch of parts can be noted, which would require frequent adjustment of the

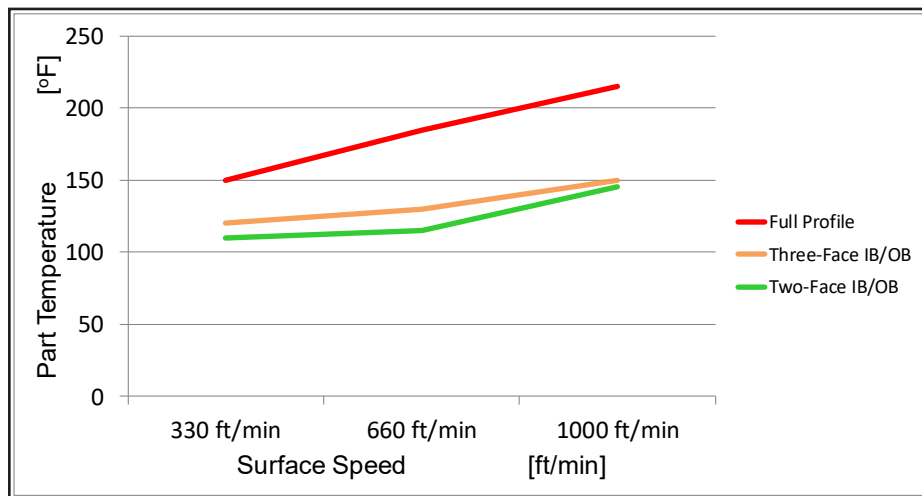

Figure 6 Part temperature versus cutting surface speed.

spacing compensation parameters. First-to-last spacing errors require a slowed down grinding cycle if the cut parts are ground after heat treatment.

Production measurements showed that a full profile blade system not only causes the highest average part temperature after cutting, but also generates the highest temperature step between the first and last cut slots compared with the inside-blade and outside-blade cutter systems.

Geometrical Aspects of Full Profile Blades

With a cutter system that only uses one kind of cutting blade, rather than three or two different blades arranged in blade groups, the logistical cost of blade blank storage, blade grinding, blade storage after grinding and cutter building is reduced to 50%, compared to an inside-blade and outside-blade cutter system. The cutter head has twice as many cutting edges for cutting the convex and the concave flanks and the same number of cutting edges cutting the root. In cases where cutting edge wear dominates over blade tip wear, the expected tool life of a full profile cutter head would be higher than the tool life of an outside-blade and inside-blade cutter head.

Higher cutting forces due to the restricted chip flow and vibrations induced by the full profile chip forming and crumbling work will adversely affect tool life, which is why the full profile blade system in practical applications does not show the anticipated tool life advantages versus the inside-blade and outside-blade cutter system.

Full profile blades can only be built to height. As shown in Figure 8, if the full profile blade was moved with the goal of re-positioning the outside cutting edge radially, then the inside cutting edge will also move radially by the same amount. This connection between inside-blade and outside-blade would only allow for a compromise in radial cutting edge position.

PentacMono—Design

A PentacMono blade (Fig. 9, center) is manufactured with an outside cutting edge that duplicates the pressure angle and shape of the full profile blade (Fig. 9, left), and has a tip edge radius that is identical to the outside edge radius of the

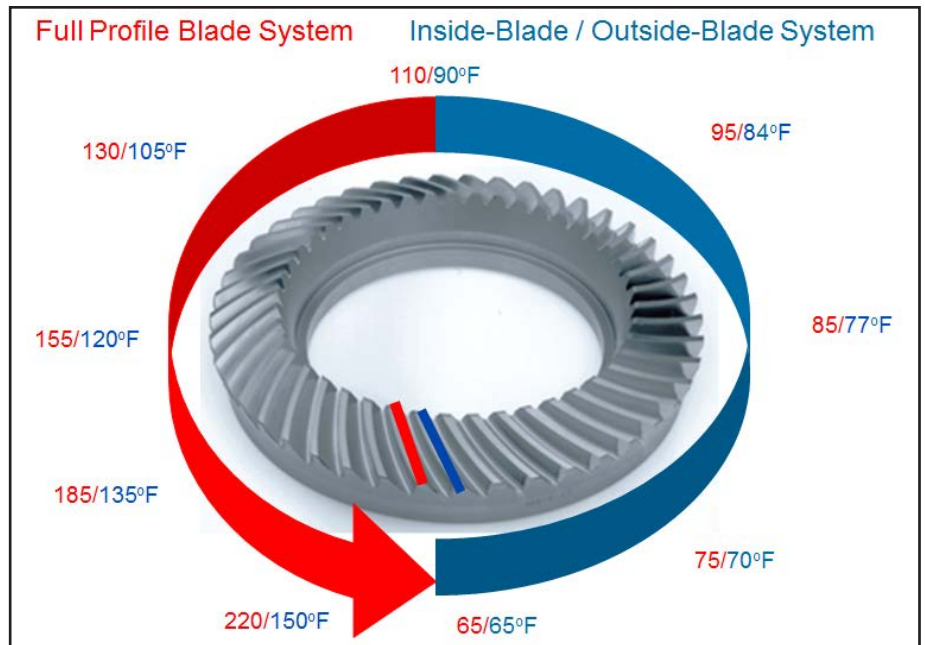

Figure 7 Temperature distribution of face milled workpieces.

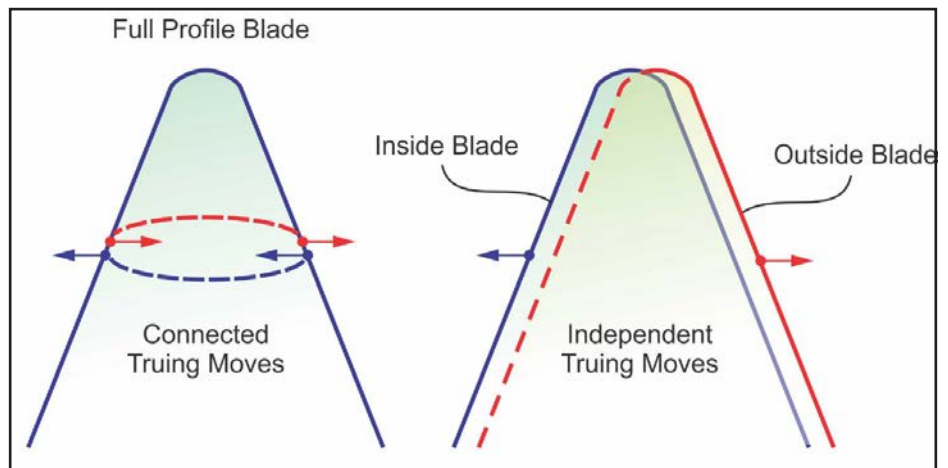

Figure 8 Radial truing only to a compromise runout value.

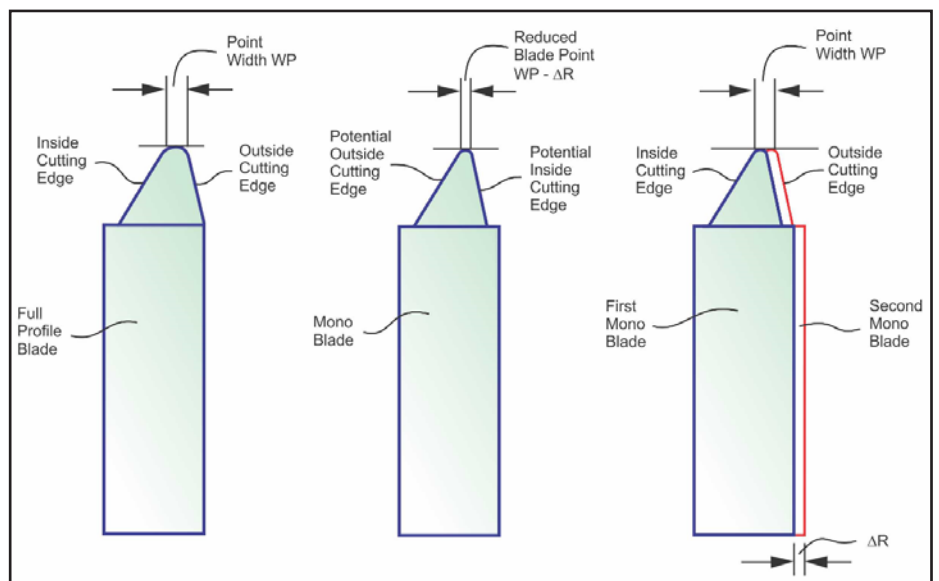

Figure 9 Comparison of full profile blade and two PentacMono blades.

full profile blade. The blade top width of the PentacMono blade is smaller than the top width of the full profile blade by an amount ΔR . Tip edge radius and cutting edge on the right side of the PentacMono blade are identical to the inside cutting edge of the full profile blade.

If two identical PentacMono blades are placed in a cutter head that has slot

bottom radii for two consecutive blade slots that differ by the amount of ΔR (Fig.9, right), then the slots cut with this cutter have the same width as the slots cut with the full profile cutter head.

The produced gear surface geometry is identical to the geometry produced by the full profile blade. Like the full profile blade, the PentacMono blade

arrangement only requires one single type of blade in order to simultaneously cut, in a completing cutter head, the convex and the concave flanks, as well as the root fillets and root bottoms.

Some important performance criteria of the PentacMono blade system are:

- The separation of the inside and outside cutting to two different blades that have the identical specification reduces the variety of different blade geometries to be administrated, handled and refurbished.
- Chip formation is more optimal and the cutting process is smoother.
- The cutting forces are lower than the cutting forces of the full profile blade that also lowers the process temperature.
- Part quality produced with PentacMono blade and cutter system is higher than part quality of the full profile blade system.

In order to realize the PentacMono blade arrangement in a cutter head, the outside blade must be positioned in a cutter head slot with a slot bottom radius which is an amount ΔR larger than the slot bottom radius of the inside blade (Fig. 10). The slot bottom radius is the radius from the cutter head axis to the blade seating surface. The different slot bottom radii in conventional cutter heads with inside and outside blades are commonly stepped. Stepping means that the inside blades have a smaller slot bottom radius than the outside blades. The difference amount between the slot bottom radii of outside and inside blades is 5-to-20 times larger than the amount ΔR required for the PentacMono blade positioning. The mentioned difference in slot bottom radii allows conventional cutter heads to cover a wide spectrum of different bevel gear designs, and also allows cutting gears of a certain module range.

In order to enable the PentacMono cutter system to also cover a wide range of different bevel gear designs and modules, the blade seating surfaces can be modified and plan-parallel spacer blocks can be connected to them. A PentacMono cutter head can be utilized with or without the spacer blocks (left versus right sequence, Fig. 10). Different sizes of the spacer blocks can be prepared in order to achieve large radius span $RW_{OB}+\Delta S$ and $RW_{IB}+\Delta S$ by making a variety of spacer blocks with different thicknesses

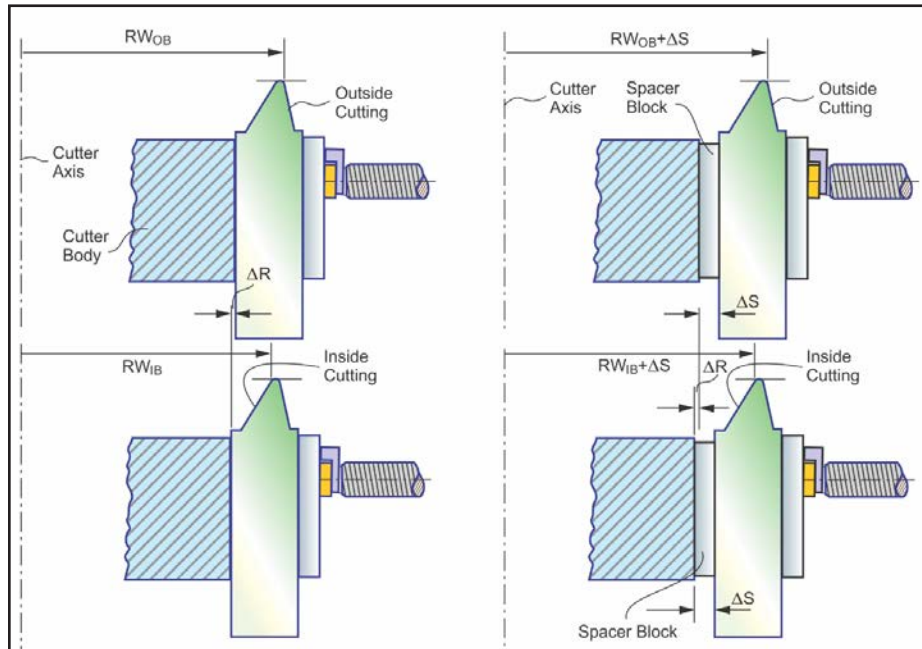

Figure 10 Blades in a PentacMono cutter head; left: without spacers, right: with spacers.

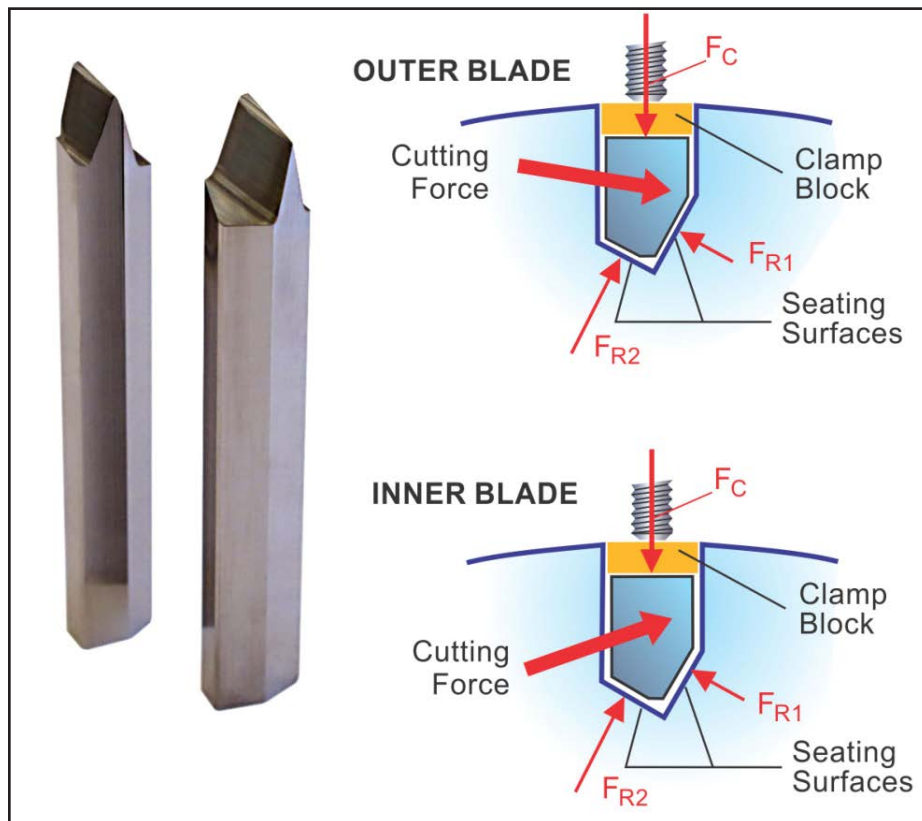

Figure 11 Pentac block blades as preferred stick blade shape for Mono blades (Ref.2).

available. In the actual PentacMono cutter head design, the difference ΔR is worked into the thickness of the spacer blocks. This not only allows the manufacture of cutter heads with equal slot bottom radii; it also makes the PentacMono system more flexible; e. g. — for different amounts of ΔR — depending on the individual gear design. This is advantageous if a wide module range has to be covered. Different spacer block thicknesses also allow a consolidation of a variety of different gear designs for the usage of the same blade geometry (in case of identical pressure angles but different gear slot widths).

The Mono-blade cutter head system has been realized in cutter heads with pentagon-shaped slot cross-section and stick blades (Fig. 11). The spacer blocks will in this case have the form of a prism, like the two examples shown (Fig. 12). The thickness of the spacer block can be manufactured in order to exactly duplicate the thickness of the rectangular spacer blocks (Fig. 10). The spacer block (Fig. 12, right) is an optimized design resulting from numerous cutting trials. The connection to the bottom of the cutter head slots is realized with only one recessed screw. In order to achieve maximum seating stiffness between the spacer block and the cutter head, surfaces labeled with “seating 1 through 3” are in contact with precision-ground surfaces in the cutter head slot. Three seating surfaces present an over-constrained system, which is why the compliance check was implemented to assure a tight fit between the spacer block and the cutter head body.

The PentacMono cutter head system is designed with radial adjustability. Figure 13 shows the blade seating surfaces that are unmodified in the upper section and have a modification on the lower section. In addition to the clamp screws in the upper location, adjustment screws have been implemented in a lower location of the outer cutter head ring. A clockwise rotation of the adjustment screw will move the tip of the blade and increase the point radius R ; a counterclockwise rotation of adjustment screw will reduce the point radius R .

Rather than modifying the cutter head seating surfaces with the relief for radial trueness, in the production version of PentacMono-RT cutter heads the relief

modification is machined onto the seating surfaces of the spacer blocks (Fig. 12, right).

The mono blade and cutter system, as it was described for the single indexing face milling process, can also be utilized in the continuous indexing face hobbing process. In order to achieve identical inside and outside blades the blade timing cannot be controlled with individual front face distances between outside and inside blades. The blade timing — the angular distance between the reference point of the inside blade cutting edge and the reference point of the outside blade cutting edge — influences the slot width and therewith the tooth thickness. If the front face distance and all other parameters of the blade that is placed in an outside slot are equal to the parameters of

the inside blade, then the correct tooth thickness in a completing cut can only be established with a change of the radial location of the cutting edges. In order to keep both blades identical, a slot width discrepancy, e.g. — $+\Delta s$ — can be corrected by increasing the radius of the inside cutting edge by $\Delta s/2$ and a reduction of the outside cutting edge radius by $\Delta s/2$. In this case the correct tooth slot width (and tooth thickness) will be achieved by using identical blades in the cutter head slots for the outside cutting, as well as in the cutter head slots for the inside cutting.

The slot radii of outside and inside cutting slots have to be located in order to achieve, for an average gear cutting, the same radius of the reference point on both the outside and the inside cutting

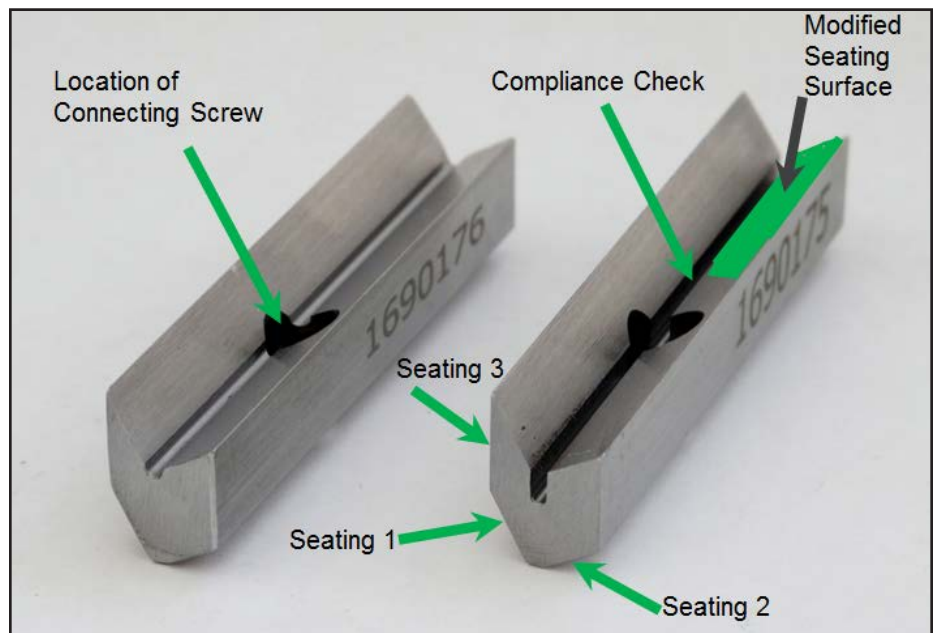

Figure 12 Blade spacer parallels adjusted to Pentac prism seating form.

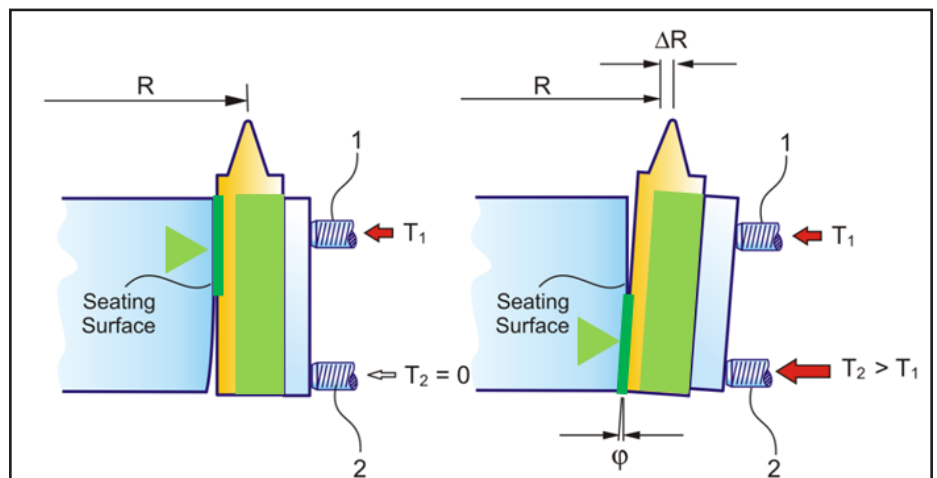

Figure 13 Modified seating surfaces for radial trueness.

edge. In order to cover a wider range of gear designs in face hobbing, spacer blocks must be utilized.

PentacMono-RT — the Best of Both Worlds

The newly developed line of PentacMono cutter heads are today available for the face milling process, and in the future will also be available for face hobbing. The side rake angle (Fig. 14) must be zero degrees to fulfill the objective of having identical blades for outside and inside cutting. In order to achieve an optimal

chip removing process, a high top rake angle of 4° is proposed that will offset the effect of the neutral side rake angle. A high top rake angle helps to start the forward-moving shear crack that lowers the forces for cold forming and plasticization. All PentacMono-RT cutter heads are designed with a 12° blade slot inclination, like PentacPlus cutters. This allows a variety of freedoms required in order to realize the mandatory zero degree side rake angle as well as the desirable high top rake angle.

The edge treatment of PentacMono

blades after blade grinding is identical to the treatment of three-face inside/outside blades. Recommended is edge honing or vapor blasting that removes loose carbide particles along the cutting edges and only leaves a trace of edge rounding; the desirable edge rounding radius is less than 2 micrometers.

A simplified principle graphic for the chip removal process of the two identical Mono blades in one blade group that have a radial offset ΔR is shown (Fig. 15). The two preceding blades (Fig. 15) act like a true outside and a true inside blade that forms rolled-up side chips (bottom) and L-shaped chips. The chip flow is identical to the chip flow of regular inside and outside blades. The side rake angle of zero degrees has to be compared to three-face ground inside/outside blades that typically have a side rake angle of 4.5°.

As mentioned above, the effect of the lower side rake angle is partially offset by the top rake angle of 4° versus 1 to 3° in regular inside/outside blades. As a result, the average part temperature of a freshly cut ring gear, for example, is at the same level as the graph for the three-face inside/outside blade cutting system (Fig. 6). Also, the temperature distribution around the circumference immediately after a face milled ring gear is finish-cut behaves very similarly to the schematic display shown in Figure 7 — especially in that the critical temperature step between the first and last cut slot is of a similar magnitude as ring gears manufactured with the traditional inside and outside blade cutter system.

Precisely radially trued blades cause less vibration during cutting action and assure that blades have a nearly equal chip load and, as a result, forms smooth cutting flats on the flank surfaces of the generated member. The result of a parameter study is shown (Fig. 16). The roll rate (degree/min) changes in the direction of the ordinate. Surface finish improvement by smoother generating marks, which are closer together, is shown in the direction of the abscissa. The diagram includes the surface roughness marks of 0.05mm that are caused by the blade cutting edges. The roughness marks are independent of the roll rate and show in each of the photos the same value; between the lower and the upper photos the roll rate doubles. For the

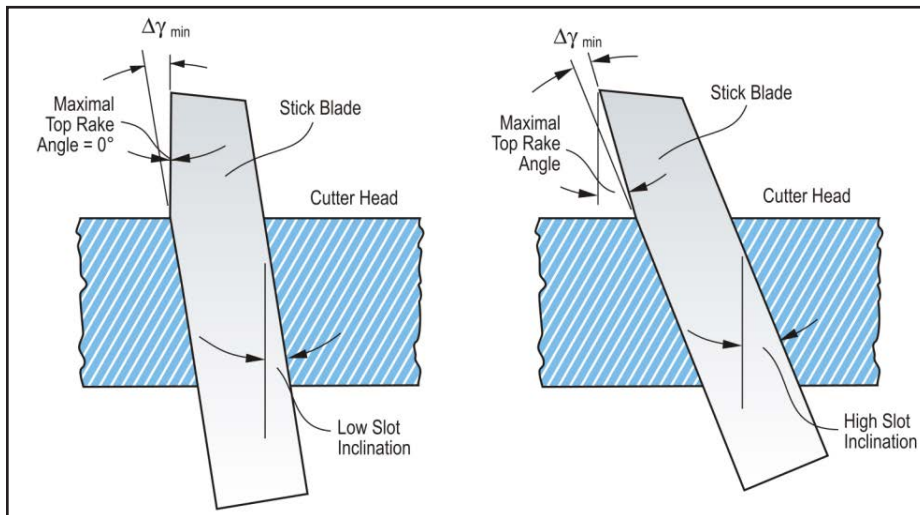

Figure 14 Higher blade slot inclination in PentacMono-RT cutter heads.

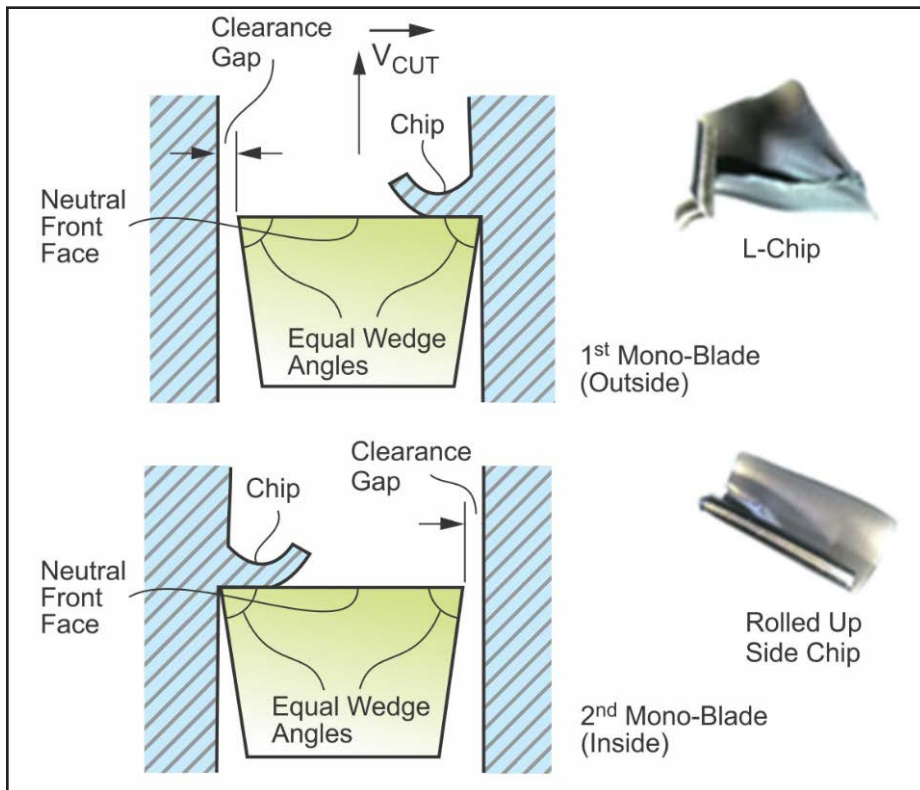

Figure 15 Simplified display of interaction between two preceding Mono blades.

un-trued cutter this translates into generating marks that nearly double. The radially trued cutter left generating marks are closer together and become nearly invisible with slow roll rates. PentacMono-RT cutter heads benefit from the radial truing feature and show surface characteristics consistent with the right-hand sequence in Figure 16.

PentacMono blades can be used for a second tool life if the blades in the inside slots of the cutter head are exchanged with the blades in the outside slots after the end of the first tool life. Cutting edges and edge radii on the non-cutting side do not wear during the first tool life run, which offers the possibility of a second use of the same blades — without the requirement of re-grinding and re-coating.

Summary

PentacMono-RT cutter heads have to be compared to full profile blade cutters with rectangular blade cross-section. Both systems use only one kind of blade that reduces the number of blade summaries and, therefore, reduces the number of different blades a manufacturer has in storage in half. In spite of the full profile cutter system, the PentacMono-RT blades take side chips. Depending on the slot in which a Mono blade is placed, it becomes an inside blade or an outside blade that makes for a free flow of small-sized L-chips and side chips (Fig. 15); the tendency for chip packing is reduced. If chip packing like that shown in Figure 5 still occurs, then the Pentac specific chip packing elimination by back face grinding can also be applied to the PentacMono-RT system.

Process heat generated by Mono blades is lower than the heat generated by full profile blades. The temperature step between the first cut and the last cut slot is greatly reduced due to good chip flow and the lower chip deformation work, compared to the energy required forming a bulky full profile chip. A temperature step between the first and last cut slot will, after the part has cooled down to room temperature, transform in a large indexing error between the teeth adjacent to those two slots. Even if parts are ground after heat treatment, the indexing error will require slower grinding and, in most practical applications, even calls for

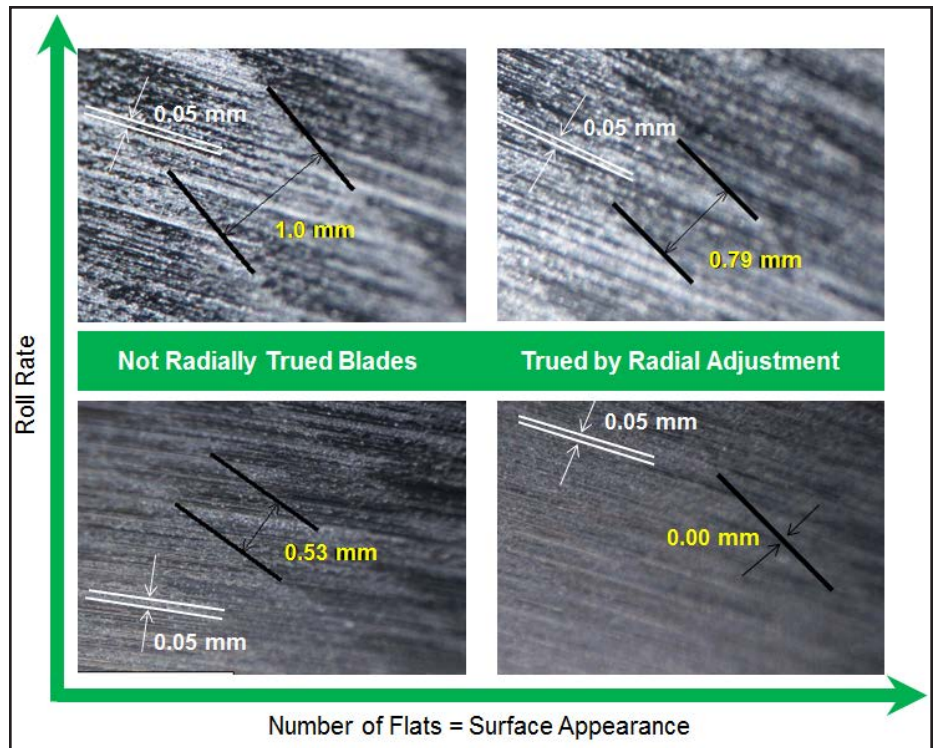

Figure 16 Surface finish improvement by radially trued side cutting blades.

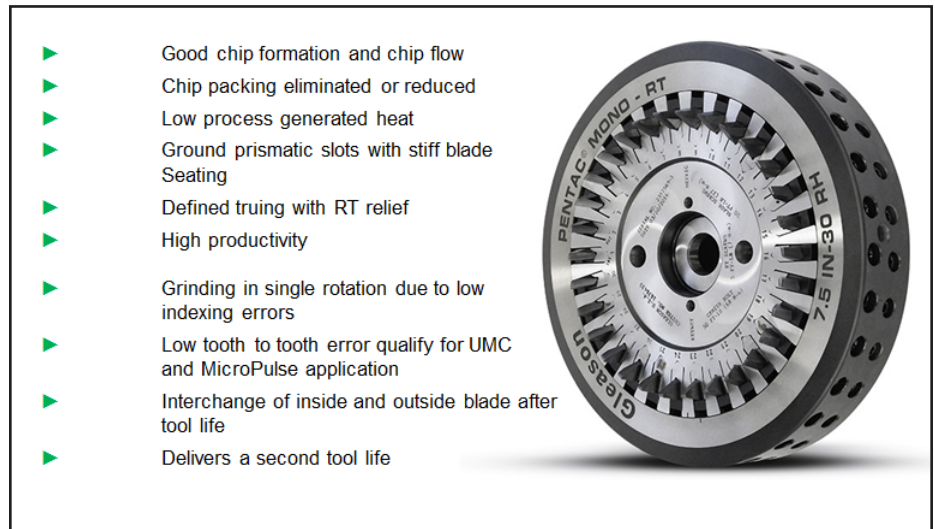

Figure 17 Advantages of PentacMono-RT cutter head.

a dual rotation in which the first rotation is used as a rough grinding cycle and the second rotation is set up as a finish grinding cycle.

The blade seating uses the prism-formed slot bottom geometry, which establishes a positive form seating between the two prism surfaces and the clamp block surface (Fig. 11).

The prism seating is asymmetric, with the intention to utilize the steeper seating surface to support the blade against the cutting forces. Slightly higher cutting forces of the zero degree side raked

blades at the moment of first cutting contact benefit from the stiff connection between blade and cutter head body.

Pentac Mono-RT cutter heads use spacer blocks with the shape of a prism (Fig. 17). The spacers have their own bottom seating in the cutter head slots with their bottom surfaces, which are formed congruent to the prismatic seat of each cutter slot. In order to increase the seating stiffness between spacers and cutter head slot bottoms, an additional surface (seating 3, Fig. 12) is precision-ground and provides in connection with

a compliance slot a slight interference fit between spacer block and cutter slot. The trueness of each PentacMono-RT cutter head is achieved by implementation of a relief surface on each spacer block (Fig. 12). Radial inaccuracies in a full profile blade cutter head cannot be eliminated by either axial blade shifting or by radial blade movements (Fig. 8). In practice, this makes some full profile blades work harder and others only rub on the surface. Both too large chip thickness and excessive surface rubbing will wear the cutting edges and can cause microchipping. Having defined blades for inside and outside cutting with a defined clearance gap on the adjacent blade edge allows the blades after cutter building to be trued to a precise radial position. Cutting performance, part quality, and tool life benefit greatly from equal distribution of the cutting load between all blades. In this case, the motto “less is more” applies. Less active cutting edges that all perform equal amounts of work will result in a higher productivity than more cutting edges that have a random pattern of cutting load distribution. After the end of a tool life, the Mono blades in the inside slots can be exchanged with the mono blades in the outside slots, which allows a second tool life without any blade re-grinding and coating.

Surface modifications — like, for example, *Universal Motions (UMC)* with three-section and ring gear end relief, as well as surface modulations like *MicroPulse* — are formed and induced in the grinding operation. However, soft cutting with a once-per-revolution index error pattern, or flank form deviations as a result of high process heat with a steep gradient around the circumference of a pinion or ring gear, will interfere with a robust grinding process and with the repeatable reproduction of the modification effects. ⚙️

References

1. Stickles, L. Guidelines for Stick-Blades and Cutters Peppers, F. Gleason Specification Sheet, October 2011.
2. Stadtfeld, H.J. *Gleason Bevel Gear Technology, The Science of Gear Engineering and Modern Manufacturing Methods for Angular Transmissions*, Company Publication, The Gleason Works, Rochester, New York, March 2014.

Dr. Hermann J. Stadtfeld

received in 1978 his B.S. and in 1982 his M.S. in mechanical engineering at the Technical University in Aachen, Germany; upon receiving his Doctorate, he remained as a research scientist at the University's Machine Tool Laboratory. In 1987, he accepted the position of head of engineering and R&D of the Bevel Gear Machine Tool Division of Oerlikon Buehrle AG in Zurich and, in 1992, returned to academia as visiting professor at the Rochester Institute of Technology. Dr. Stadtfeld returned to the commercial workplace in 1994—joining The Gleason Works—also in Rochester—first as director of R&D, and, in 1996, as vice president R&D. During a three-year hiatus (2002–2005) from Gleason, he established a gear research company in Germany while simultaneously accepting a professorship to teach gear technology courses at the University of Ilmenau. Stadtfeld subsequently returned to the Gleason Corporation in 2005, where he currently holds the position of vice president, bevel gear technology and R&D. A prolific author (and frequent contributor to *Gear Technology*), Dr. Stadtfeld has published more than 200 technical papers and 10 books on bevel gear technology; he also controls more than 50 international patents on gear design, gear process, tools and machinery.



For more information.

Questions or comments regarding this paper? Please contact Dr. Hermann Stadtfeld; hstadtfeld@gleason.com.

For Related Articles Search

bevel gears

at www.geartechnology.com